



VALUE PANEL PLUS



VALUE PANEL PLUS - DUAL WATTAGE

The Value Panel Plus, designed to cater to diverse lighting needs at an affordable price. Featuring dual wattage, this panel is complemented by a low-glare diffuser (UGR<19) making it perfect for both office settings and classrooms. Its versatile TRI colour switch allows for seamless transitions between warm white (3000K), cool white (4000K), and daylight (5700K), ensuring optimal lighting for any application. Built for lasting performance, the IP54-rated luminaire is dust-protected and suitable for damp environments, providing reliable, adaptable lighting solutions.

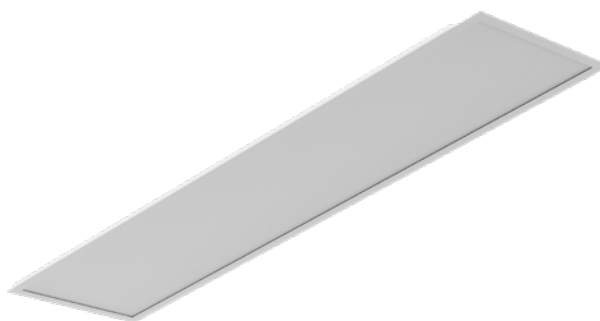

FEATURES AND BENEFITS

- Dual wattage version: 20/15W, 33/27W or 49/45W
- Available in 300x600mm, 600x600mm, 300x1200mm and 600x1200mm
- Tri colour in 3000K, 4000K, and 5700K
- High efficacy up to 120lm/W
- Beam angle 90°
- Low glare rating of UGR<19
- IP54
- Pre-wired with flex and plug
- Lifetime 50000 hours

AREAS OF APPLICATION

- Offices and conference rooms
- Reception areas and foyers
- Entrances and hallways
- Retail and hospitality
- Libraries and schools

AVAILABLE SIZES

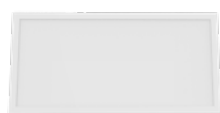

20/15W
595x295x32mm

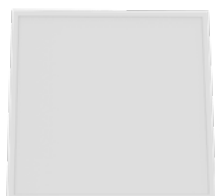

33/27W
595x595x32mm

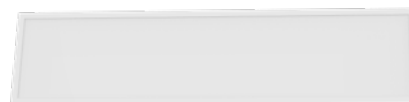

33/27W
1195x295x32mm

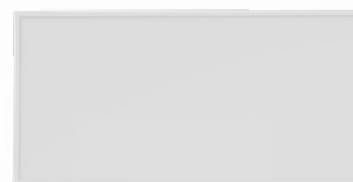

49/45W
1195x595x34mm

SPECIFICATIONS

Wattage	20/15W, 33/27W, 49/45W	Connection Type	Pre-wired with flex and plug
Lumens	2400, 4000, 5850	PF	>0.9
lm/W	120	Voltage	220-240V
CCT	3000/4000/5700K	Input Current	58/120mA, 105/200mA, 170/280mA
IP Rating	IP54(Front)/IP20(Back)	Frequency	50/60Hz
Dimmable	No	Surge Protection	1KV
Housing Material	PMMA	Mounting Type	Recessed mounting
Beam Angle	90°	Operating Temperature	-10°C to 40°C
CRI	>80	Lifetime	50000 hours
SDCM	<5	Warranty	5 years
UGR	<19		
Electrical Classification	Class II		

PHOTOMETRICS

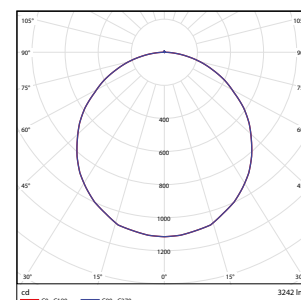

DIMENSIONS

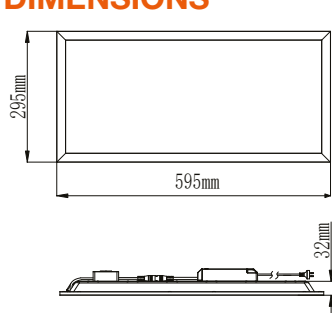

20/15W
595x295x32mm

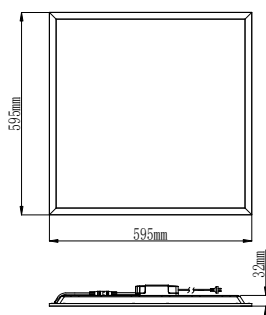

33/27W
595x595x32mm

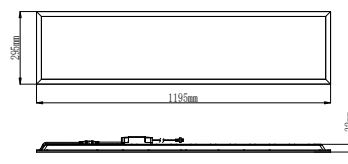

33/27W
1195x295x32mm

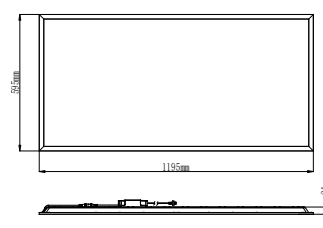

49/45W
1195x595x34mm

VALUE PANEL PLUS - PHASE DIMMABLE

The Value Panel Plus, designed to cater to diverse lighting needs at an affordable price. Featuring phase dimming options, this panel is complemented by a low-glare diffuser (UGR<19) making it perfect for both office settings and classrooms. Its versatile TRI colour switch allows for seamless transitions between warm white (3000K), cool white (4000K), and daylight (5700K), ensuring optimal lighting for any application. Built for lasting performance, the IP54-rated luminaire is dust-protected and suitable for damp environments, providing reliable, adaptable lighting solutions.

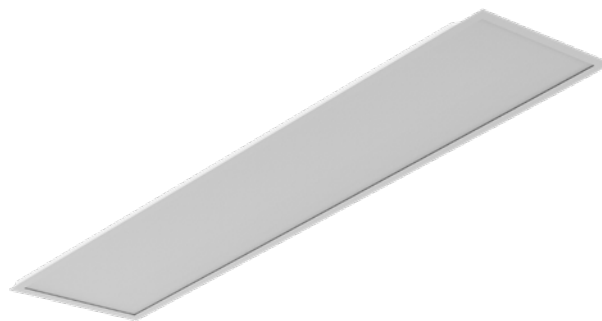

FEATURES AND BENEFITS

- 33W, 49W
- Phase dimmable
- Available in 600x600mm, 300x1200mm and 600x1200mm
- Tri colour in 3000K, 4000K, and 5700K
- High efficacy up to 120lm/W
- Beam angle 90°
- Low glare rating of UGR<19
- IP54
- Pre-wired with flex and plug
- Lifetime 50000 hours

AREAS OF APPLICATION

- Offices and conference rooms
- Reception areas and foyers
- Entrances and hallways
- Retail and hospitality
- Libraries and schools

AVAILABLE SIZES

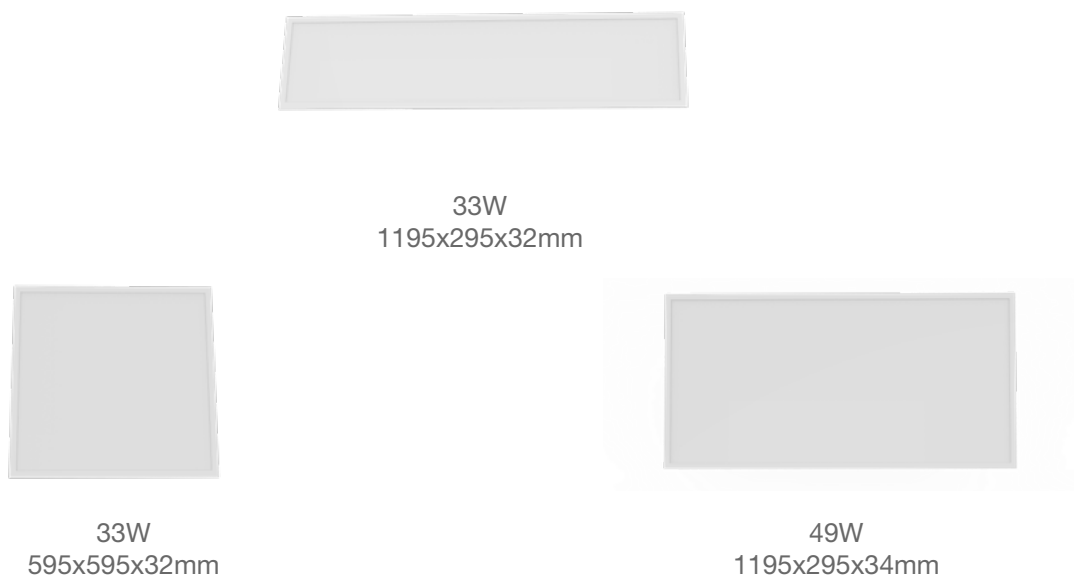

SPECIFICATIONS

Wattage	33W, 49W	Connection Type	Pre-wired with flex and plug
Lumens	4000, 5850	PF	>0.9
lm/W	120	Voltage	220-240V
CCT	3000/4000/5700K	Input Current	200mA, 280mA
IP Rating	IP54(Front)/IP20(Back)	Frequency	50/60Hz
Dimmable	Phase dimming	Surge Protection	1KV
Housing Material	PMMA	Mounting Type	Recessed mounting
Beam Angle	90°	Operating Temperature	-10°C to 40°C
CRI	>80	Lifetime	50000 hours
SDCM	<5	Warranty	5 years
UGR	<19		
Electrical Classification	Class II		

PHOTOMETRICS

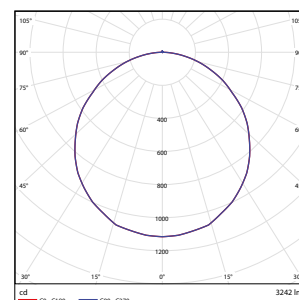

DIMENSIONS

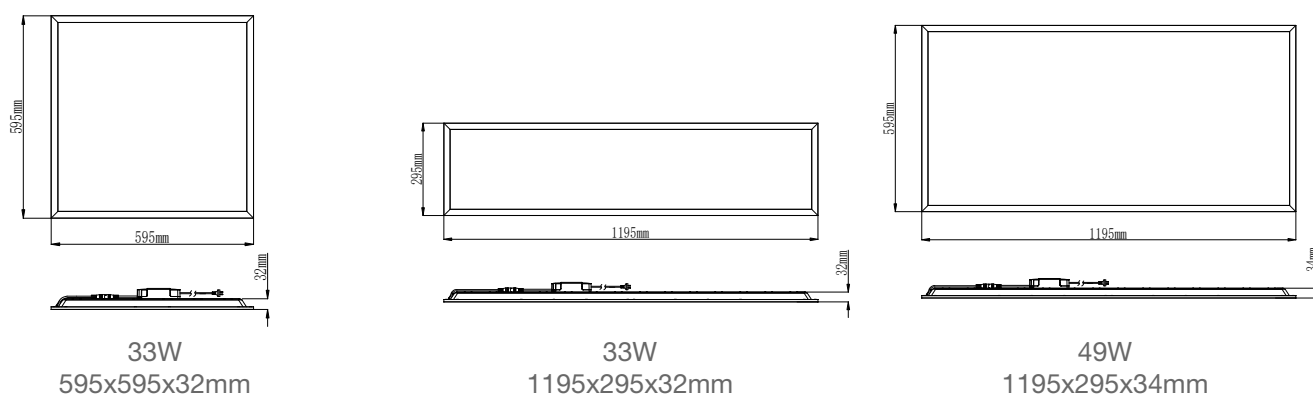

VALUE PANEL PLUS - DALI DIMMABLE

The Value Panel Plus, designed to cater to diverse lighting needs at an affordable price. Featuring DALI dimming options, this panel is complemented by a low-glare diffuser (UGR<19) making it perfect for both office settings and classrooms. Its versatile TRI colour switch allows for seamless transitions between warm white (3000K), cool white (4000K), and daylight (5700K), ensuring optimal lighting for any application. Built for lasting performance, the IP54-rated luminaire is dust-protected and suitable for damp environments, providing reliable, adaptable lighting solutions.

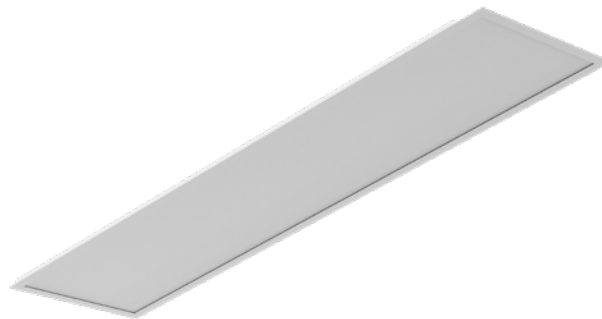

FEATURES AND BENEFITS

- 33W, 49W
- DALI dimmable
- Available in 600x600mm, 300x1200mm and 600x1200mm
- Tri colour in 3000K, 4000K, and 5700K
- High efficacy up to 120lm/W
- Beam angle 90°
- Low glare rating of UGR<19
- IP54
- Pre-wired with flex and plug
- Lifetime 50000 hours

AREAS OF APPLICATION

- Offices and conference rooms
- Reception areas and foyers
- Entrances and hallways
- Retail and hospitality
- Libraries and schools

AVAILABLE SIZES

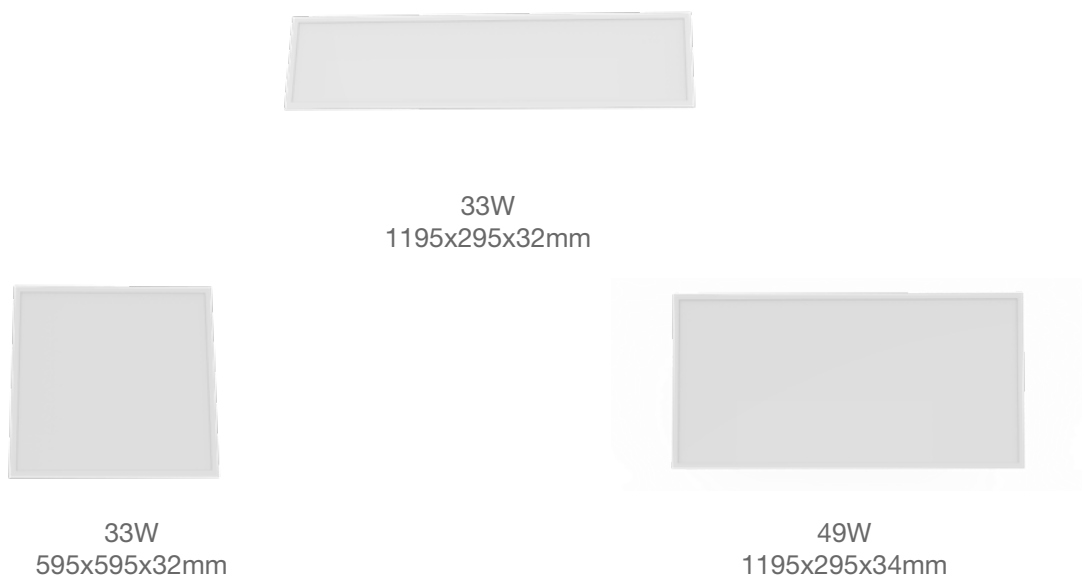

SPECIFICATIONS

Wattage	33W, 49W	Connection Type	Pre-wired with flex and plug
Lumens	4000, 5850	PF	>0.9
lm/W	120	Voltage	220-240V
CCT	3000/4000/5700K	Input Current	340mA
IP Rating	IP54(Front)/IP20(Back)	Frequency	50/60Hz
Dimmable	DALI	Surge Protection	1KV
Housing Material	PMMA	Mounting Type	Recessed mounting
Beam Angle	90°	Operating Temperature	-10°C to 40°C
CRI	>80	Lifetime	50000 hours
SDCM	<5	Warranty	5 years
UGR	<19		
Electrical Classification	Class II		

PHOTOMETRICS

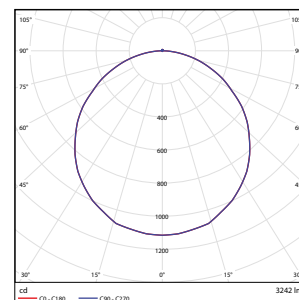

DIMENSIONS

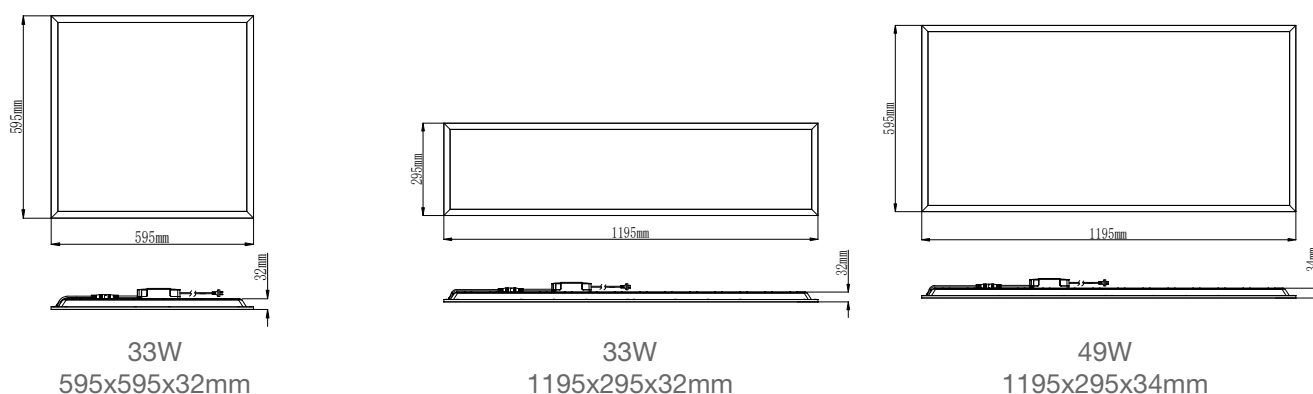

ORDERING CODES - VALUE PANEL PLUS



Product name	EAN10	Model number	W	lm	K	°	lm/w	°	l [mm]	w [mm]	h [mm]	g
--------------	-------	--------------	---	----	---	---	------	---	--------	--------	--------	---

DUAL WATTAGE

LDVAL PAN0306 20/15W TRI UGR19 6X1AULEDV	4099854298257	LDVPAN030620/15WTRI	20/ 15	2400/ 1800	3000/ 4000/ 5700	90	120	×	595	295	32	1000
LDVAL PAN0606 33/27W TRIUGR19 6X1AULEDV	4099854246944	LDVPAN060633/27WTRI	33/ 27	4000/ 3240	3000/ 4000/ 5700	90	120	×	595	595	32	1834
LDVAL PAN0312 33/27W TRIUGR19 6X1AULEDV	4099854246968	LDVPAN031233/27WTRI	33/ 27	4000/ 3240	3000/ 4000/ 5700	90	120	×	1195	295	32	1844
LDVAL PAN0612 49/45W TRIUGR19 4X1AULEDV	4099854246982	LDVPAN061249/45WTRI	49/ 45	5850/ 5400	3000/ 4000/ 5700	90	120	×	1195	595	34	3634

PHASE DIM

LDVAL PAN0606 33W TRI UGR19DIM6X1AULEDV	4099854247132	LDVPAN060633WTRIDIM	33	4000	3000/ 4000/ 5700	90	120	PHASE DIM	595	595	32	1875
LDVAL PAN0312 33W TRI UGR19DIM6X1AULEDV	4099854247156	LDVPAN031233WTRIDIM	33	4000	3000/ 4000/ 5700	90	120	PHASE DIM	1195	295	32	1885
LDVAL PAN0612 49W TRI UGR19DIM4X1AULEDV	4099854247170	LDVPAN061249WTRIDIM	49	5850	3000/ 4000/ 5700	90	120	PHASE DIM	1195	595	34	3770











DALI

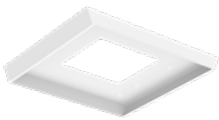

LDVAL PAN0606 33W TRIUGR19DALI6X1AULEDV	4099854247002	LDVPAN060633WTRIDALI	33	4000	3000/ 4000/ 5700	90	120	DALI	595	595	32	1930
LDVAL PAN0312 33W TRIUGR19DALI6X1AULEDV	4099854247057	LDVPAN031233WTRIDALI	33	4000	3000/ 4000/ 5700	90	120	DALI	1195	295	32	1940
LDVAL PAN0612 49W TRIUGR19DALI4X1AULEDV	4099854247095	LDVPAN061249WTRIDALI	49	5850	3000/ 4000/ 5700	90	120	DALI	1195	595	34	3700

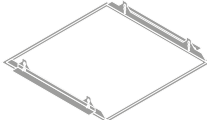
ORDERING CODES - PANEL ACCESSORIES

VALUE
CLASSLEDVANCE
5 year
guarantee

Product name	EAN10	Model number				
SURFACE MOUNT FRAME						
						
LDVAL PAN SURFACE FRAME 0606 2X1 AU LEDV	4099854246760	LDVPANSMF0606	600	654	65.5	2280
LDVAL PAN SURFACE FRAME 0312 2X1 AU LEDV	4099854246746	LDVPANSMF0312	1200	354	65.5	2690
RECESSED CEILING KITS (Suitable for plaster ceiling)						
						
LDVAL PAN RECESSKIT 0606 G2 4X1 AU LEDV	4058075737563	LDVPANRECESSK0606	634	634	38.1	598
LDVAL PAN RECESSKIT 0306 G2 4X1 AU LEDV	4058075737501	LDVPANRECESSK0306	634	334	38.1	455
LDVAL PAN RECESSKIT 0312 G2 4X1 AU LEDV	4058075737594	LDVPANRECESSK0312	1234	234	38.1	755
LDVAL PAN RECESSKIT 0612 G2 4X1 AU LEDV	4058075737624	LDVPANRECESSK0612	1234	634	38.1	899
SUSPENSION KITS						
						
LDVAL PAN SUSKIT G2 10X1 AU LEDV	4058075737655	LDVPANSUSKIT	1500	N/A	N/A	105
VALUE DIMMER (Universal)						
						
MS-DP-UNIV-ROT 300W 230V 30X1 AU LEDVAU	4058075555259	LDVDIMMERUNIV	23.7	23.7	56	24.5

ABOUT LEDVANCE

With offices in more than 50 countries and business activities in more than 140 countries, LEDVANCE is one of the world's leading general lighting providers for professional users and end consumers. Having emerged from the general lighting business of OSRAM GmbH, LEDVANCE offers a wide-ranging assortment of LED luminaires for a broad spectrum of application areas, intelligent lighting products for Smart Homes and Buildings, one of the largest LED lamps portfolios in the industry as well as traditional light sources.



LEDVANCE

Customer Service
Phone: 1300 467 726
E-mail: sales.au@ledvance.com

LEDVANCE Pty Ltd
Unit 3, 83 Derby St
Silverwater NSW 2128
Australia

LEDVANCE.COM.AU



VALUE PANEL PLUS 24/04/24