



VALO™

BY M-ELEC



ALL YOUR 24V LED STRIP NEEDS

- ✔ LED strip
- ✔ ALU housing
- ✔ Controllers
- ✔ Power supplies





24V LED Strip Lighting | Indoor Single Colour



Standard LED Strip

ML-VL-4.8-W5* White 5m
 ML-VL-4.8-NW5* Neutral White 5m
 ML-VL-4.8-WW5* Warm White 5m

ML-VL-4.8-W50* White 50m
 ML-VL-4.8-NW50* Neutral White 50m
 ML-VL-4.8-WW50* Warm White 50m

Total Power Consumed (p/m) 4.8W
 Lumen Output (p/m) (WW) 260lm | (NW) 370lm | (W) 380lm
 Efficacy 75-79lm/W
 Input Voltage 24V DC
 Colour Temperature 3000K (WW) | 4000K (NW) | 6000K (W)
 LED Chip & Qty SMD3528 | 60/m
 Beam Angle 120°
 Dimmable Yes (with correct power supply and controller)
 Approx Min Cut 100mm
 Maximum Run Length 10m
 IP Rating IP20
 Dimensions L 5m x W 8mm / L 50m x W 8mm
 Operating Temperature -40 to 70°C
 Average Life 40,000 hrs
 Warranty 7 Years
 Kit Includes 1 x 5m/50m LED strip, 5/25 x connectors, 3M tape



Long Run LED Strip

ML-VLMX7.2-W50* White 50m
 ML-VLMX7.2-NW50* Neutral White 50m
 ML-VLMX7.2-WW50* Warm White 50m

Total Power Consumed (p/m) 7.2W
 Lumen Output (p/m) (WW) 700lm | (NW) 750lm | (W) 750lm
 Efficacy 97-104lm/W
 Input Voltage 24V DC*
 Colour Temperature 3000K (WW) | 4000K (NW) | 6000K (W)
 LED Chip & Qty SMD2835 | 60/m
 Beam Angle 120°
 Dimmable Yes (with correct power supply and controller)
 Approx Min Cut 100mm
 Maximum Run Length 20m
 IP Rating IP20
 Dimensions L 50m x W 12mm
 Operating Temperature -40 to 70°C
 Average Life 40,000 hrs
 Warranty 7 years
 Kit Includes 1 x 50m LED strip, 25 x connectors, 3M tape



High Output LED Strip

ML-VL-9.6-W5* White 5m
 ML-VL-9.6-NW5* Neutral White 5m
 ML-VL-9.6-WW5* Warm White 5m

ML-VL-9.6-W50* White 50m
 ML-VL-9.6-NW50* Neutral White 50m
 ML-VL-9.6-WW50* Warm White 50m

Total Power Consumed (p/m) 9.6W
 Lumen Output (p/m) (WW) 720lm | (NW) 740lm | (W) 760lm
 Efficacy 75-79lm/W
 Input Voltage 24V DC
 Colour Temperature 3000K (WW) | 4000K (NW) | 6000K (W)
 LED Chip & Qty SMD3528 | 120/m
 Beam Angle 120°
 Dimmable Yes (with correct power supply and controller)
 Approx Min Cut 50mm
 Maximum Run Length 10m
 IP Rating IP20
 Dimensions L 5m x W 8mm / L 50m x W 8mm
 Operating Temperature -40 to 70°C
 Average Life 40,000 hrs
 Warranty 7 years
 Kit Includes 1 x 5m/50m LED strip, 5/25 x connectors, 3M tape

24V LED Strip Lighting | Indoor Single Colour



Laser LED Strip

ML-VLLZ-10-W50* White 50m
 ML-VLLZ-10-NW50* Neutral White 50m
 ML-VLLZ-10-WW50* Warm White 50m

Total Power Consumed (p/m)	10W
Lumen Output (p/m)	(WW) 910lm (NW) 989lm (W) 1080lm
Efficacy	91-108lm/W
Input Voltage	24V DC
Colour Temperature	3000K (WW) 4000K (NW) 6500K (W)
LED Chip & Qty	COB 512/m
Beam Angle	120°
Dimmable	Yes (with correct power supply and controller)
Approx Min Cut	62.5mm
Maximum Run length	10m
IP Rating	IP20
Dimensions	L 5m x W 10mm / L 50m x W 10mm
Operating Temperature	-40 to 70°C
Average Life	40,000 hrs
Warranty	7 years
Kit Includes	1 x 50m LED strip, 25 x connectors, 3M tape

Ultra Bright LED Strip

ML-VL-11.5-W5* White 5m
 ML-VL-11.5-NW5* Neutral White 5m
 ML-VL-11.5-WW5* Warm White 5m

ML-VL-11.5-W50* White 50m
 ML-VL-11.5-NW50* Neutral White 50m
 ML-VL-11.5-WW50* Warm White 50m



Total Power Consumed (p/m)	11.5W
Lumen Output (p/m)	(WW) 1470lm (NW) 1590lm (W) 1610lm
Efficacy	127-140lm/W
Input Voltage	24V DC
Colour Temperature	3000K (WW) 4000K (NW) 6000K (W)
LED Chip & Qty	SMD3014 128/m
Beam Angle	120°
Dimmable	Yes (with correct power supply and controller)
Approx Min Cut	62.5mm
Maximum Run Length	10m
IP Rating	IP20
Dimensions	L 5m x W 10mm / L 50m x W 10mm
Operating Temperature	-40 to 70°C
Average Life	40,000 hrs
Warranty	7 years
Kit Includes	1 x 5m/50m LED strip, 5/25 x connectors, 3M tape

24V LED Strip Lighting | Indoor Single Colour



High Output Full Spectrum LED Strip

ML-VLCRI-14.4-W5 White 5m ML-VLCRI-14.4-W50 White 50m
 ML-VLCRI-14.4-NW5 Neutral White 5m ML-VLCRI-14.4-NW50 Neutral White 50m
 ML-VLCRI-14.4-WW5 Warm White 5m ML-VLCRI-14.4-WW50 Warm White 50m

Total Power Consumed 14.4W
 Lumen Output (WW) 880lm | (NW) 980lm | (W) 1010lm
 Efficacy 61-70lm/W
 Input Voltage 24V DC
 Colour Temperature 3000K (WW) | 4000K (NW) | 6000K (W)
 LED Chip & Qty SMD2835 | 60/m
 Beam Angle 120°
 Dimmable Yes (with correct power supply and controller)
 Approx Min Cut 100mm
 Maximum Run Length 10m
 IP Rating IP20
 Dimensions L 5m x W 10mm / L 50m x W 10mm
 Operating Temperature -40 to 70°C
 Average Life 40,000 hrs
 Warranty 7 years
 Kit Includes 1 x 5m/50m LED strip, 5/25 x connectors, 3M tape

Max Output LED Strip

ML-VL-17.2-W50* White 50m
 ML-VL-17.2-NW50* Neutral White 50m
 ML-VL-17.2-WW50* Warm White 50m

Total Power Consumed (p/m) 17.2W
 Lumen Output (p/m) (WW) 2200lm | (NW) 2370lm | (W) 2410lm
 Efficacy 127-140lm/W
 Input Voltage 24V DC
 Colour Temperature 3000K (WW) | 4000K (NW) | 6500K (W)
 LED Chip & Qty SMD3014 | 192/m
 Beam Angle 120°
 Dimmable Yes (with correct power supply and controller)
 Approx Min Cut 41.6mm
 Maximum Run Length 5m
 IP Rating IP20
 Dimensions L 3m x W 10mm / L 50m x W 10mm
 Operating Temperature -40 to 70°C
 Average Life 40,000 hrs
 Warranty 7 years
 Kit Includes 1 x 50m LED strip, 25 x connectors, 3M tape





24V LED Strip Lighting | Indoor RGB



Standard RGB LED Strip

ML-VL-7.2-RGB* Colour Changing 5m
ML-VL-7.2-RGB50 Colour Changing 50m

Total Power Consumed	7.2W
Input Voltage	24V DC
Colour Temperature	RGB
LED Chip & Qty	SMD5050 30/m
Beam Angle	120°
Dimmable	Yes (with correct power supply and controller)
Approx Min Cut	166.7mm
Maximum Run Length	10m
IP Rating	IP20
Dimensions	L 5m x W 10mm / L 50m x W 10mm
Operating Temperature	-40 to 70°C
Average Life	40,000 hrs
Warranty	7 years
Kit Includes	1 x 5m/50m LED strip, 5/25 x connectors, 3M tape



Standard RGB, W/NW/WW LED Strip

ML-VL-12-RGBW50* Colour Changing 50m
ML-VL-12-RGBNW50* Colour Changing 50m
ML-VL-12-RGBWW50* Colour Changing 50m

Total Power Consumed	12W
Lumen Output	(WW) 650lm (NW) 700lm (W) 700lm
Efficacy	54-58lm/W
Input Voltage	24V DC
Colour Temperature	(WW)RGB+3000K (NW)RGB+4000K (W)RGB+6500K
LED Chip & Qty	SMD2110 320/m
Beam Angle	120°
Dimmable	Yes (with correct power supply and controller)
Approx Min Cut	150mm
Maximum Run Length	10m
IP Rating	IP20
Dimensions	L 50m x W 10mm
Operating Temperature	-40 to 70°C
Average Life	40,000 hrs
Warranty	7 years
Kit Includes	1 x 50m LED Strip, 25 x connectors, 3M tape



High Output RGB LED Strip

ML-VL-14.4-RGB5* Colour Changing 5m
ML-VL-14.4-RGB50 Colour Changing 50m

Total Power Consumed	14.4W
Input Voltage	24V DC
Colour Temperature	RGB
LED Chip & Qty	SMD5050 60/m
Beam Angle	120°
Dimmable	Yes (with correct power supply and controller)
Min Cut	100mm
Maximum Run Length	10m
IP Rating	IP20
Dimensions	L 5m x W 10mm / L 50m x W 10mm
Operating Temperature	-40 to 70°C
Average Life	40,000 hrs
Warranty	7 years
Kit Includes	1 x 5m/50m LED strip, 5/25 x connectors, 3M tape

24V LED Strip Lighting | Indoor RGB



RGB Laser LED Strip

ML-VLLZ-15-RGB50* RGB 50m

Total Power Consumed (p/m)	15W
Input Voltage	24V DC
Colour Temperature	RGB
LED Chip & Qty	COB 840
Beam Angle	180°
Dimmable	Yes (with correct power supply and controller)
Approx Min Cut	50mm
Maximum Run length	10m
IP Rating	IP20
Dimensions	L 50000mm x W 10x H 2.3mm
Operating Temperature	-40 to 70°C
Average Life	40,000 hrs
Warranty	7 years
Kit Includes	1 x 50m LED strip, 25 x connectors, 3M tape

RGBWW Laser LED Strip

ML-VLLZ-16-RGBWW50* RGB Warm White 50m



Total Power Consumed (p/m)	16W
Input Voltage	24V DC
Colour Temperature	RGBWW
LED Chip & Qty	SMD3014 896
Beam Angle	180°
Dimmable	Yes (with correct power supply and controller)
Approx Min Cut	62.5mm
Maximum Run Length	10m
IP Rating	IP20
Dimensions	L 50000mm x W 12mm x H 2.3mm
Operating Temperature	-40 to 70°C
Average Life	40,000 hrs
Warranty	7 years
Kit Includes	1 x 50m LED strip, 25 x connectors, 3M tape

24V LED Strip Lighting | Outdoor Single Colour



Weather Protected Standard LED Strip

ML-VLWP-4.8-W5 White 5m ML-VLWP-4.8-W10 White 10m
 ML-VLWP-4.8-NW5 Neutral White 5m ML-VLWP-4.8-NW10 Neutral White 10m
 ML-VLWP-4.8-WW5 Warm White 5m ML-VLWP-4.8-WW10 Warm White 10m

Total Power Consumed 4.8W
 Lumen Output (WW) 330lm | (NW) 340lm | (W) 370lm
 Efficacy 68-77lm/W
 Input Voltage 24V DC
 Colour Temperature 3000K (WW) | 4000K (NW) | 6000K (W)
 LED Chip & Qty SMD3528 | 60/m
 Beam Angle 120°
 Dimmable Yes (with correct power supply and controller)
 Min Cut 100mm
 Maximum Run Length 10m
 IP Rating IP65
 Dimensions L 5m x W 10.5mm / L 10m x W 10.5mm
 Operating Temperature -40 to 70°C
 Average Life 40,000 hrs
 Warranty 7 years
 Kit Includes 1 x 5m/10m LED strip, 20/40 x saddles, 4/8 x end-caps, 1 x connector with cable, 1 x end connector seal

Weather Protected High Output LED Strip

ML-VLWP-9.6-W White 5m ML-VLWP-9.6-W10 White 10m
 ML-VLWP-9.6-NW Neutral White 5m ML-VLWP-9.6-NW10 Neutral White 10m
 ML-VLWP-9.6-WW Warm White 5m ML-VLWP-9.6-WW10 Warm White 10m



Total Power Consumed 9.6W
 Lumen Output (WW) 660lm | (NW) 730lm | (W) 770lm
 Efficacy 69-80lm/W
 Input Voltage 24V DC
 Colour Temperature 3000K (WW) | 4000K (NW) | 6000K (W)
 LED Chip & Qty SMD2216 | 120/m
 Beam Angle 120°
 Dimmable Yes (with correct power supply and controller)
 Approx Min Cut 50mm
 Maximum Run Length 10m
 IP Rating IP65
 Dimensions L 5m x W 10.5mm / L 10m x W 10.5mm
 Operating Temperature -40 to 70°C
 Average Life 40,000 hrs
 Warranty 7 years
 Kit Includes 1 x 5m/10m LED strip, 20/40 x saddles, 4/8 x end-caps, 1 x connector with cable, 1 x end connector seal

Weather Protected Ultra Bright LED Strip

ML-VLWP-11.5-W5 White 5m ML-VLWP-11.5-W10 White 10m
 ML-VLWP-11.5-NW5 Neutral White 5m ML-VLWP-11.5-NW10 Neutral White 10m
 ML-VLWP-11.5-WW5 Warm White 5m ML-VLWP-11.5-WW10 Warm White 10m



Total Power Consumed 11.5W
 Lumen Output (WW) 1470lm | (NW) 1590lm | (W) 1610m
 Efficacy 128-140lm/W
 Input Voltage 24V DC
 Colour Temperature 3000K (WW) | 4000K (NW) | 6000K (W)
 LED Chip & Qty SMD3014 | 128/m
 Beam Angle 120°
 Dimmable Yes (with correct power supply and controller)
 Approx Min Cut 62.5mm
 Maximum Run Length 10m
 IP Rating IP65
 Dimensions L 5m x W 12.5mm / L 10m x W 12.5mm
 Operating Temperature -40 to 70°C
 Average Life 40,000 hrs
 Warranty 7 years
 Kit Includes 1 x 5m/10m LED strip, 20/40 x saddles, 4/8 x end-caps, 1 x connector with cable, 1 x end connector seal

24V LED Strip Lighting | Outdoor Single Colour



Neon LED Strip

ML-VLN-9.6-W20 WHITE 20M*

Total Power Consumed	9.6W
Lumen Output	(W) 1220lm
Efficacy	127lm/W
Input Voltage	24V DC
Colour Temperature	6000K (W)
LED Chip & Qty	SMD2835 128/m
Beam Angle	150°
Dimmable	Yes (with correct power supply and controller)
Min Cut	100mm
Maximum Run Length	10m
IP Rating	IP65
Dimensions	L 20m x W 12mm x H 12mm
Operating Temperature	-40 to 70°C
Average Life	40,000 hrs
Warranty	7 years
Kit Includes	1x 20m LED strip, 8x end-cap with hole, 8x end-cap without hole, 40x mounting clips, 4 x input cables with 100cm bare wire 4 x input cables with 100cm bare wire



24V LED Strip Lighting | Outdoor RGB



Weather Protected Standard RGB LED Strip

ML-VLWP-7.2-RGB5 Colour Changing 5m
ML-VLWP-7.2-RGB10 Colour Changing 10m

Total Power	7.2W
Input Voltage	24V DC
Colour Temperature	RGB
LED Chip & Qty	SMD5050 30/m
Beam Angle	120°
Dimmable	Yes (with correct power supply and controller)
Approx Min Cut	166.7mm
Maximum Run length	10m
IP Rating	IP65
Dimensions	L 5m x W 12.5mm / L 10m x W 12.5mm
Operating Temperature	-40 to 70°C
Average Life	40,000 hrs
Warranty	7 years
Kit Includes	1 x 5m/10m LED strip, 20/40 x saddles, 4/8 x end-caps, 1 x connector with cable, 1 x end connector seal

Weather Protected High Output RGB LED Strip

ML-VLWP-14.4-RGB5 Colour Changing 5m



Total Power Consumed	14.4W
Input Voltage	24V DC
Colour Temperature	RGB
LED Chip & Qty	SMD5050 60/m
Beam Angle	120°
Dimmable	Yes (with correct power supply and controller)
Approx Min Cut	100mm
Maximum Run length	10m
IP Rating	IP65
Dimensions	L 5m x W 12.5mm
Operating Temperature	-40 to 70°C
Average Life	40,000 hrs
Warranty	7 years
Kit Includes	1 x 5m LED strip, 20 x saddles, 4 x end-caps, 1 x connector with cable, 1 x end connector seal

Neon LED Strip

ML-VLN-14.4-RGB20° Colour Changing 20m



Total Power Consumed	14.4W
Input Voltage	24V DC
Colour Temperature	RGB
LED Chip & Qty	SMD2835 120/m
Beam Angle	120°
Dimmable	Yes (with correct power supply and controller)
Approx Min Cut	150mm
Maximum Run Length	5m
IP Rating	IP20
Dimensions	L 50m x W 10mm
Operating Temperature	-40 to 70°C
Average Life	40,000 hrs
Warranty	7 years
Kit Includes	1x 20m LED strip, 8x end-cap with hole, 8x end-cap without hole, 40x mounting clips, 4 x input cables with 100cm bare wire, 4 x input cables with 100cm bare wire





RGB Colour

ML-RGBC30

Rated Voltage	300V
Suitable Voltage	12-24V DC
Conductor Size	0.38mm ²
Colour Conductors	Red, green, blue & black
Flame Retardant Grade	VW-1
Rated Temperature	80°C
Length	30m



RGBW Colour

ML-RGBWC30

Rated Voltage	300V
Suitable Voltage	12-24V DC
Conductor Size	0.38mm ²
Colour Conductors	Green, black, red, white & blue
Flame Retardant Grade	VW-1
Rated Temperature	80°C
Length	30m

LED Strip | Accessories

Strip to Strip Connectors (5pk)

All suitable for indoor or outdoor flexible strips



3
YEAR
WNTY

ML-SSS-X1 Single colour strip connector suits 8mm wide flexible strips
ML-SSS-X1-10 Single colour strip connector suits 10mm wide flexible strips
ML-RGB-SS-X1-10 RGB strip connector suits 10mm wide flexible strips
ML-RGBW-SS-X1 RGB strip connector suits 12mm wide flexible strips

Strip-Strip Flex Connectors (5pk)

All suitable for indoor or outdoor flexible strips

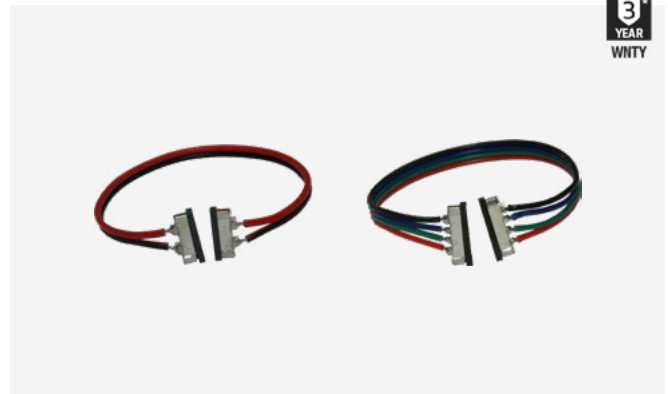

3
YEAR
WNTY

ML-CURVE-X1 Single colour strip connector suits 8mm wide flexible strips
ML-RGB-CURVE-X1 RGB strip connector suits 10mm wide flexible strips

Strip to Strip Power Connectors (5pk)

All suitable for indoor or outdoor flexible strips



3
YEAR
WNTY

ML-SSP-X1 Single colour strip-power connector suits 8mm wide flexible strips
ML-RGB-SP-X1 RGB strip connector suits 10mm wide flexible strips
ML-RGBW-SP-X1 RGBW strip connector suits 12mm wide flexible strips

Aluminium Housing



Universal 2/4m Aluminium Profile

ML-ALU2-K-V3 Aluminium Profile Kit (2m length)
ML-ALU4-K-V3 Aluminium Profile Kit (4m length)

Size	L 2/4m x W 19mm x H 12mm
2m Kit Includes	1 x 2m Aluminium housing 1 x 2m Opaque diffuser (ML-ALU2-DIFF-V3) 2 x End-caps (ML-ALU2/4-EC-V3)
4m Kit Includes	1 x 4m Aluminium housing 1 x 4m Opaque diffuser (ML-ALU4-DIFF-V3) 2 x End-caps (ML-ALU2/4-EC-V3)
Minimum Order Optional	2 Kits (minimum due to safe packing methods) 2m Clear diffuser (ML-ALU2-DIFFC-V3) 4m Clear diffuser (ML-ALU4-DIFFC-V3)

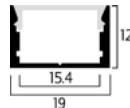

Recessed Aluminium Profile

ML-ALUR-K-V3 Aluminium Profile Kit

Size	L 2m x W 25mm x H 7mm
Cut Out Width	17.3mm
Kit Includes	1 x 2m Aluminium housing, 1 x 2m Opaque diffuser (ML-ALUR-DIFF-V3), 2 x End-caps (ML-ALUR-EC-V3), 4 x Mounting brackets (ML-ALUR-MB-V3)
Minimum Order	2 Kits (minimum due to safe packing methods)

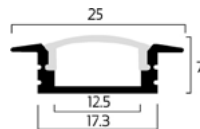

Corner Aluminium Profile

ML-ALUCR-K-V3 Aluminium Profile Kit

Size	L 2m x W 16mm x H 16mm
Kit Includes	1 x 2m Aluminium housing, 1 x 2m Opaque diffuser (ML-ALUCR-DIFF-V3), 2 x End-caps (ML-ALUCR-EC-V3), 3 x Mounting brackets (ML-ALUCR-MB-V3)
Minimum Order	2 Kits (minimum due to safe packing methods)

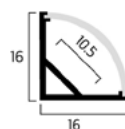

Aluminium Housing

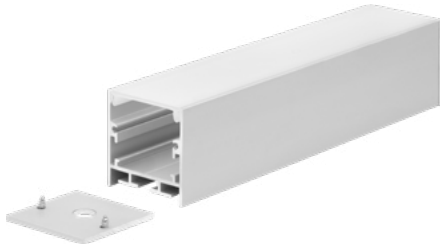

Suspended Aluminium Profile

ML-ALUSUS-K-V3 Aluminium Profile Kit

Size	L 4m x W 35mm x H 35mm
Kit Includes	1 x 4m Aluminium housing, 1 x 4m Opaque diffuser (ML-ALUSUS-DIFF-V3), 2 x End-caps (ML-ALUSUS-EC-V3), 1 x Suspension kit (ML-ALUSUS-KIT-V3)
Individual Suspension Kit	4 x roof fixing points, 4 x profile fixing points, 4 x 1200mm suspension wire 2 x Screws
Minimum Order	1 Kit
Optional	Spring bracket (ML-ALU-SUS-SB) Joining bracket (ML-ALU-SUS-JN)

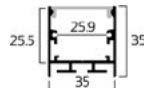

Click-in Aluminium Profile

ML-ALU-1407-4M Aluminium Profile Kit

Size	L 4m x W 14mm x H 7mm
Kit Includes	1 x 4m aluminium profile 1 x 4m opaque diffuser (ML-ALU-1407-4M) 4 x End caps - 1 x with hole, 1 x without hole (ML-ALU-1407-EC) 4 x mounting brackets (ML-ALU-1407-MB)
Minimum Order	2 Kits (minimum due to safe packing methods)

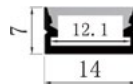

The 1407 is perfect for low profile, rectangular cutouts or slim surface mounted installation requirements and comes with clips allowing pre-wired strips already installed in the profile to take place, saving labour time.

Aluminium Housing

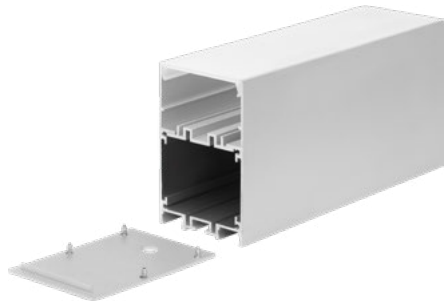

Surface Aluminium Profile



ML-ALU-5075-4M Aluminium Profile Kit

Size	L 4m x W 50mm x H 75mm
Kit Includes	1 x 4m Aluminium profile 1 x 4m Opaque diffuser 4 x End caps -4 x with hole, 4 x without hole (ML-ALU-5075-EC) 4 x Mounting brackets (ML-ALU-5075-MB)
Minimum Order	1 Kit
Optional	Suspension kit (ML-ALUSUS-KIT-V3)

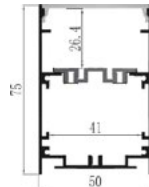

The 5075 is the perfect profile for long lengths of custom LED strips installed with ease. With a removable tray the profile allows for LED strips to be installed on the tray with space for cable or direct fixing to occur directly behind it and when ready for the tray to simply be clipped into place.

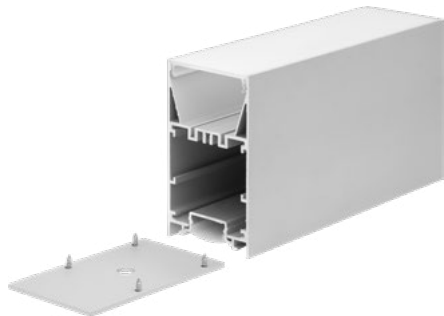

Dual Illumination Aluminium Housing



ML-ALU-5085-4M Aluminium Profile Kit

Size	L 4m x W 50mm x H 85mm
Kit Includes	1 x 4m Aluminium profile 1 x 4m Opaque diffuser 4 x End caps -4 x with hole, 4 x without hole (ML-ALU-5085-EC) 4 x Mounting brackets (ML-ALU-5085-MB)
Minimum Order	1 Kit
Optional	Suspension kit (ML-ALUSUS-KIT-V3)

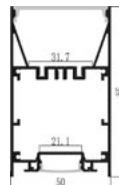

The 5085 profile has both direct and indirect illumination outlets for top and bottom cover. With a large diffuser on toward the ground the internal space (31.7mm) allows for multiple LED strips to be installed and the top allows for another LED strip to wash the ceilings creating incredible illumination with ease.



LED Controllers



RF Wall Controller

ML-2836DIM-US

Functions
Operating Voltage
Operating Frequency
Dimensions
Required Receiver

On/Off switch and 0-100% dimmer
3V (CR2032 not included)
434MHz RF
L 75mm x H 120mm x D 41mm
ML-VLC-C5

This simple '1-wheel' dimmer controller is completely wireless and battery operated allowing it to be installed with ease. The 1 wheel configuration allows full dimming control (256 levels) and on/off capability. The controller has a power saving mode which allows the replaceable battery to last up to 2 years.



RGB Wall Touch Panel Controller

ML-2820-US3

Colour Control
Functions
Input Voltage
Operating Frequency
Dimensions
Required Receiver

RGB + white
3 zone controller (separately or synchronized), RGBW colour change speed, 10 changing modes, dimming and speed control
240V AC
434MHz RF
L 75mm x H 120mm x D 30.5mm
ML-VLC-C5

The ML-2820-US3 glass wall controller from M-Elec allows easier connections without the need for complicated wiring or connections. With a simple interface, the ML-2820-US3 allows the user to have 3 separate zones which can be operated separately or can be synchronized. With 10 pre-set colour sequences and full RGB/W control, the ML-2820-US3 is both easy to wire and operate.

LED Controllers



Single Colour Remote Controller

ML-2819SDIM

Colour Control Functions
 Operating Voltage
 Operating Frequency
 Dimensions
 Required Receiver

Single colour
 Control 4 zones (separately or synchronised) 3 different scenes & dimming control
 4.5VDC battery (not included)
 434MHz
 L 55mm x H 120mm x D 17mm
 ML-VLC-C5

The single colour controller offers smooth and consistent remote dimming via RF (Radio Frequency) to control any LED product connected to the receiver (purchased separately). The ML-2819SDIM also features 4 zone control and 3 memory functions that can memorise your favourite settings.



RGBW Remote Controller

ML-2819S

Colour Control Functions
 Operating Voltage
 Operating Frequency
 Dimensions
 Required Receiver

RGB + white
 RGB colour change, white control, 4 zones (separate or synchronised), 3 different scenes & dimming control
 4.5VDC battery (3xAAA not included)
 434MHz
 L 55mm x H 120mm x D 21mm
 ML-VLC-C5

The RGBW wireless controller is the 'all round' pick of remotes for RGB and RGBW LED strips. Working with the ML-VLC-C5 this remote can control colours, 4 zones and a white output. With 10 preset colour changing modes this remote is very universal in its applications.



RGBW Remote Controller

ML-2819T8

Colour Control Functions
 Operating Voltage
 Dimensions
 Required Receiver

RGB + white
 RGB colour change, white control, 8 zones, speed & brightness control
 3VDC battery (2 x AAA not included)
 L 44mm x H 131mm x D 24mm
 ML-VLC-C5

This RGBW wireless remote offers up to 8 zones of RGBW all in 1 remote. Working wirelessly with the ML-VLC-C5 receiver this remote has full control of all colours individually and allows both speed and brightness control of the various modes. Supplied with storage cradle.

LED Controllers

1-10V Signal Dimmer

ML-DIM-S

M-Elec's plate mounted 1-10V signal dimmer allows the user to blend the 1-10V controller with traditional dimmers and switch plates seamlessly. Integrating into conventional standard style switch plates and working with one or multiple 1-10V controllers, the ML-DIM-S will dim LED strips and modules perfectly.

*Dimmer only, plate not included



0-10V 4 Channel Dimmer

ML-2002

Input Voltage	12-36VDC
Input Control	0-10V signal
Input Channels	4
Output Power	4 x (60-180)W
Output Channels	4
Dimensions	L 166mm x H 23mm x D 53.4mm

The 0-10V 4 channel dimmer allows full control of strips and other constant voltage products. 0-10V gives superior dimming control with 256 levels on each channel. Capable of working with 1-10V dimmer controllers (ML-DIM-S) and other 0-10V inputs such as Dynalite and C-Bus systems (see manufacturer for details).



LED Controllers

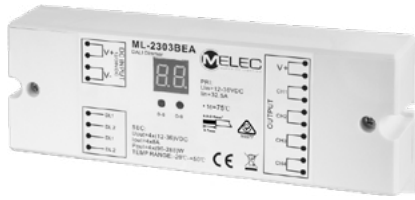

4 Channel DALI Dimmer

ML-2303BEA

Colour Control	RGB, RGB + white or Hybrid strips
Input Voltage	12-36VDC
Input Control	DALI
Input Channels	4
Output Power	4 x (96-288)W
Suitable Strip	RGB, CCT & RGBW
Output Current	1-4A x 4 channels
Dimensions	L 169mm x H 59mm x D 28.6mm

The new 4 channel DALI dimmer unit allows easy DALI address programming either manually or automatically offering RGB, RGB + white or Hybrid strip colour control from the one unit. Digital indicator for address display, with 4 channel capability the DALI addresses can be set from 1 to 4, matching all DALI systems in the market place.



5 Channel Controller



ML-VLC-C5

Colour Control	CCT, RGBW, RGB+CCT, DIMMING
Input Voltage	12-24VDC
Output Current	5 x 4A
Output Power	5 x 48-96W
Output Type	12-24V constant voltage output
Operating Temperature	-20°C-+50°C
Dimensions	L 145 x H 46.5 x D 16mm
Warranty	7 years

The C5 controller offers remote (RF) or Wi-Fi (Tuya App) control and is able to handle RGB, RGB+W, RGB+W+WW, CCT, or single channel dimming.

24V Power Supplies | Non Dimmable



Constant Voltage Non Dimmable



ML-VLPS-C30

Power (Max)	30W
Input Voltage	240V
Output Voltage	24V DC
Outputs	1
IP Rating	IP20
Warranty	7 years
Size	L 260mm x W 30mm x H 18.5mm
Kit Includes	1 x Power supply with flex & plug



Constant Voltage Non Dimmable



ML-VLPS-C60

Power (Max)	60W
Input Voltage	240V
Output Voltage	24V DC
Outputs	1
IP Rating	IP20
Warranty	7 years
Size	L 300mm x W 30mm x H 18.5mm
Kit Includes	1 x Power supply with flex & plug



Constant Voltage Non Dimmable



ML-VLPS-C100

Power (Max)	100W
Input Voltage	240V
Output Voltage	24V DC
Outputs	1
IP Rating	IP20
Warranty	7 years
Size	L 368mm x W 30mm x H 22.5mm
Kit Includes	1 x Power supply with flex & plug



Constant Voltage Non Dimmable



ML-VLPS-C150

Power (Max)	150W
Input Voltage	240V
Output Voltage	24V DC
Outputs	1
IP Rating	IP20
Warranty	7 years
Size	L 368mm x W 30mm x H 22.5mm
Kit Includes	1 x Power supply with flex & plug



24V Power Supplies | Non Dimmable

Constant Voltage Non Dimmable

ML-VLPS-C200



Power (Max)	200W
Input Voltage	240V
Output Voltage	24V DC
Outputs	2
IP Rating	IP66
Warranty	7 years
Size	L 256mm x W 78mm x H 47mm
Kit Includes	1 x Power supply with flex & plug

Constant Voltage Non Dimmable

ML-VLPS-C300



Power (Max)	300W
Input Voltage	240V
Output Voltage	24V DC
Outputs	2
IP Rating	IP66
Warranty	7 years
Size	L 276mm x W 78mm x H 47mm
Kit Includes	1 x Power supply with flex & plug

Constant Voltage Non Dimmable

ML-VLPS-C360



Power (Max)	360W
Input Voltage	240V
Output Voltage	24V DC
Outputs	2
IP Rating	IP66
Warranty	7 years
Size	L 276mm x W 78mm x H 47mm
Kit Includes	1 x Power supply with flex & plug

24V Power Supplies | Dimmable



Constant Voltage Dimmable



ML-VLPS-D30

Power (Max)	30W
Dimmable	Yes (Triac, 0/1-10V, Potentiometer, 10V PWM)
Input Voltage	200-240V AC
Output Voltage	24V DC
Outputs	1
IP Rating	IP66
Warranty	7 years
Size	L 260mm x W 32mm x H 20mm



Constant Voltage Dimmable



ML-VLPS-D60

Power (Max)	60W
Dimmable	Yes (Triac, 0/1-10V, Potentiometer, 10V PWM)
Input Voltage	200-240V AC
Output Voltage	24V DC
Outputs	1
IP Rating	IP66
Warranty	7 years
Size	L 300mm x W 32mm x H 20mm



Constant Voltage Dimmable



ML-VLPS-D100

Power (Max)	100W
Dimmable	Yes (Triac, 0/1-10V, Potentiometer, 10V PWM)
Input Voltage	200-240V AC
Output Voltage	24V DC
Outputs	1
IP Rating	IP66
Warranty	7 years
Size	L 330mm x W 32mm x H 20mm



Constant Voltage Dimmable



ML-VLPS-D150

Power (Max)	150W
Dimmable	Yes (Triac, 0/1-10V, Potentiometer, 10V PWM)
Input Voltage	200-240V AC
Output Voltage	24V DC
Outputs	1
IP Rating	IP66
Warranty	7 years
Size	L 368mm x W 32mm x H 23mm

24V Power Supplies | Dimmable



Constant Voltage Dimmable

ML-VLPS-D200

Power (Max)	200W
Dimmable	Yes (Triac, 0/1-10V, Potentiometer, 10V PWM)
Input Voltage	200-240V AC
Output Voltage	24V DC
Outputs	1
IP Rating	IP66
Warranty	7 years
Size	L 256mm x W 8mm x H 47mm



Constant Voltage Dimmable

ML-VLPS-D300

Power (Max)	300W
Dimmable	Yes (Triac, 0/1-10V, Potentiometer, 10V PWM)
Input Voltage	200-240V AC
Output Voltage	24V DC
Outputs	1
IP Rating	IP66
Warranty	7 years
Size	L 276mm x W 78mm x H 47mm



Constant Voltage Dimmable

ML-VLPS-D360

Power (Max)	360W
Dimmable	Yes (Triac, 0/1-10V, Potentiometer, 10V PWM)
Input Voltage	200-240V AC
Output Voltage	24V DC
Outputs	1
IP Rating	IP66
Warranty	7 years
Size	L 276mm x W 78mm x H 47mm

24V LED Strip Power Supply Chart

Dimmable Power Supply		Strip Watts/m	4.8W	7.2W	9.6W	10W	11.5W	14.4W	17.2W
		Max strip Length	10m	20m	10m	10m	10m	10m	5m
Power Supply	Voltage	Wattage	Strip Length Per Power Supply						
VLPS-D30	24V	30W	6.25m	4.16mm	3.13m	3m	2.6m	2.08m	1.8m
VLPS-D60	24V	60W	12.5m*	8.33m	6.25m	6m	5.21m	4.16m	3.5m
VLPS-D100	24V	100W	20.8m*	13.89m	10.42m*	10m	8.69m	6.95m	5.8m*
VLPS-D150	24V	150W	31.25m*	20.83m*	15.6m*	15m*	13.04m*	10.42m*	8.72m*
VLPS-D200	24V	200W	41.67m*	27.78m*	20.83m*	20m*	17.4m*	13.89m*	11.62m*
VLPS-D300	24V	300W	62.5m*	41.66m*	31.25m*	30m*	26.08m*	20.84m*	17.44m*
VLPS-D360	24V	360W	75m*	50m*	37.5m*	36m*	31.3m*	25m*	20.93m*

Non-dimmable Power Supply		Strip Watts/m	7.2W-RGB	12W-RGBW	14.4W-RGB
		Max strip Length	10m	10m	10m
Power Supply	Voltage	Wattage	Strip Length Per Power Supply		
VLPS-C30	24V	30W	4.16m	2.5m	2.08m
VLPS-C60	24V	60W	8.33m	5m	4.16m
VLPS-C100	24V	100W	13.89m*	8.34m	6.95m
VLPS-C150	24V	150W	20.83m*	12.5m*	10.42m*
VLPS-C200	24V	200W	27.78m*	16.66m*	13.89m*
VLPS-C300	24V	300W	41.66m*	25m*	20.84m*
VLPS-C360	24V	360W	50m*	30m*	25m*

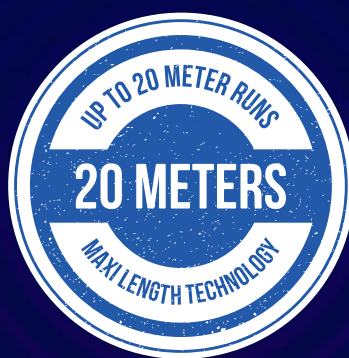

*Exceeded max strip length may vary



Online Tools
Scan now



LED STRIP CALCULATORS

Easy to use online tools that can help make purchasing
LED strip lighting simple!

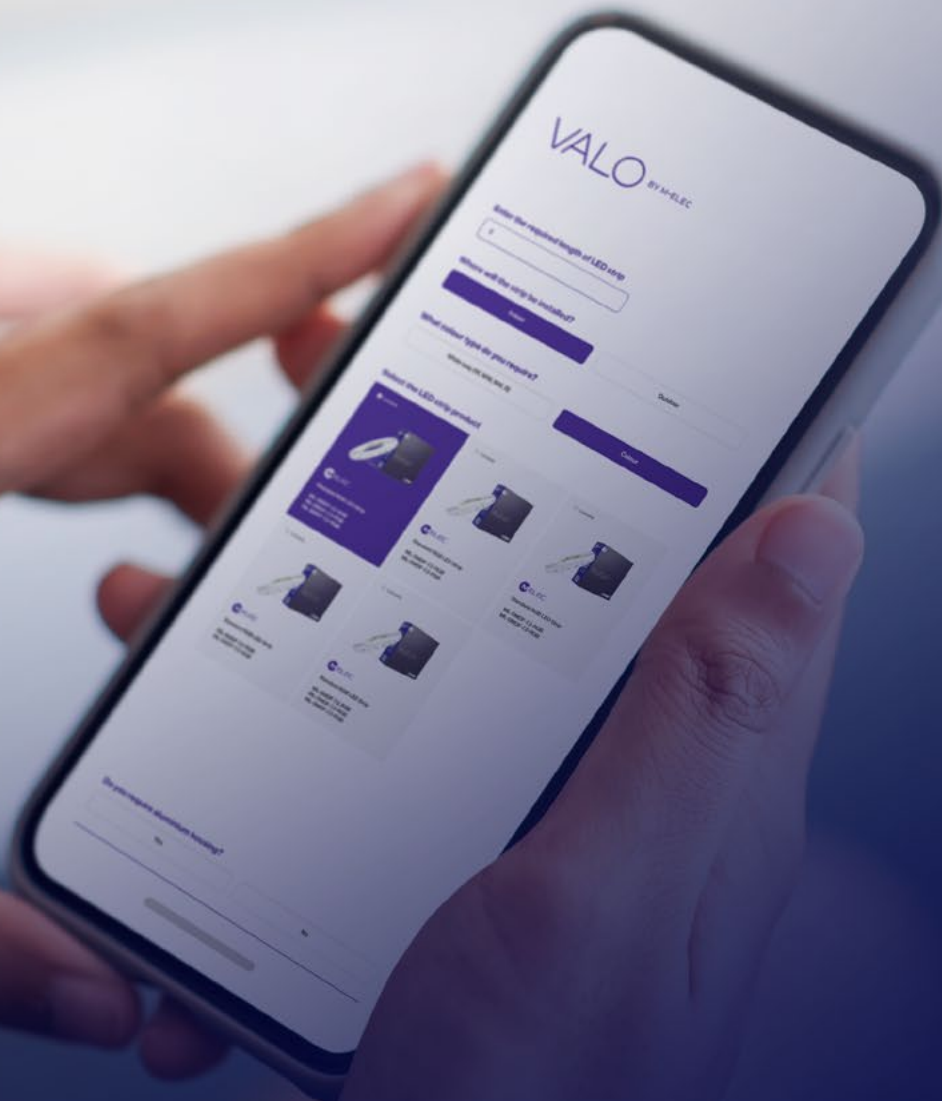



Cutting Service
Scan now



LED STRIP & ALU CUTTING SERVICE

We'll cut • We'll solder • We'll deliver



* Terms & conditions apply: Dependent on product availability & volume. 24 hour turn around & dispatch available for confirmed orders of less than \$1000 (ex GST) and received before 12.00pm. Delivery times may vary.

VALO™



At **M-World** our goal is to not to just supply electricians with the best products but the best services as well.
Be part of the electrical community today.

Register for free now
mel.ec/mworld

Free onsite warranty for 3 years.
Includes labour & hire.
In conjunction with your standard product warranty.

We've got your back.

