

BESMOKEY10BW

*See current catalogue for further detail



Page 1 of 2

Cleaning Guide:

Spraying cleaning products on to electrical products is not recommended. It is important to ensure that switches are turned off before cleaning.

Do not use any cleaning sprays - only wipe down with damp cloth or rub with dry cloth. (Do not use an abrasive cloth as it may scratch the plastic).

Do not use harsh chemical cleaners as these can break down the plastic and cause it to crack.

BESMOKEY10 Smoke Alarms come with a 10 Year Warranty from date of purchase. BESMOKEY10 Accessories are warranted for 7 Years from date of purchase. Proof of Purchase is required for Warranty Claims – please see www.gsme.com.au for details regarding warranty claims.

Bear Photoelectric Smoke Alarm Wireless (Non Removable) Lithium Battery Only

- Photoelectric Sensing Technology.
- Activfire Listed.
- Complies with AS3786:2014.
- Main power source: Built-in DC3V Lithium battery (battery not replaceable).
- Interconnection Max. 40 alarms.
- Wireless distance Max. 100 metres in free field.
- Wireless Frequency test 433.42MHZ
- Suitable for Ceiling or Wall Mounting.
- Alarm volume $\geq 85\text{dB(A)}$ @ 3m complying with ISO8201 alarm pattern.
- Operating Temperature $0^\circ\text{C} - 45^\circ\text{C}$.
- Maximum humidity for installation: $< 93\%$ Relative Humidity.
- Central test & Activation Button.
- Red LED Alarm Status Indication.
- Insect Screen protects Sensing Chamber.
- Sleek Styling.
- The BESMOKEY10BW can also pair to BESMOKEY10 with BESMOKEY10WM installed.
- 10 Year warranty.

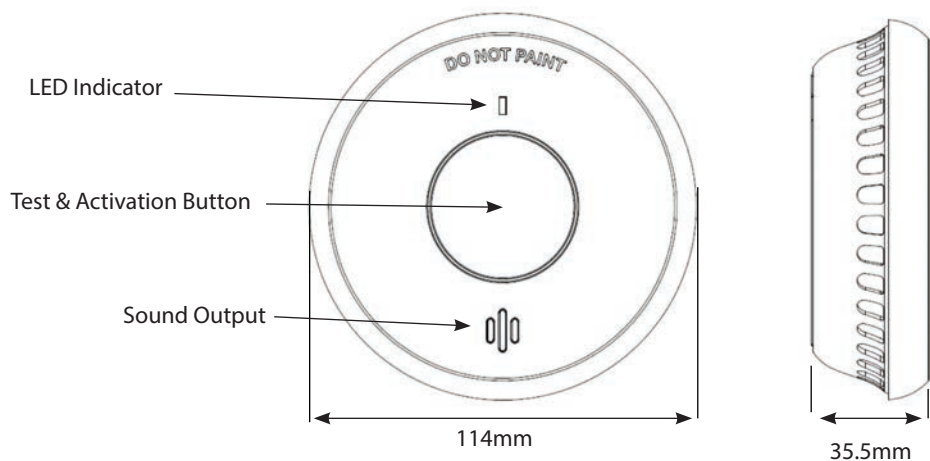

Catalogue Number	Description
BESMOKEY10BW	Smoke Alarm Wireless Interconnect Photoelectric Surface Mount Non Removable 3V DC Lithium 10 Year Battery Only

Certification Number:
Active Fire: afp-3735

GSM Electrical (Australia) Pty Ltd
Level 2, 142-144 Fullarton Road, Rose Park SA 5067
P: 1300 301 838 F: 1300 301 778 E: service@gsme.com.au
www.gsme.com.au



BESMOKEY10BW

*See current catalogue for further detail



Page 2 of 2

Cleaning Guide:

Spraying cleaning products on to electrical products is not recommended.

It is important to ensure that switches are turned off before cleaning.

Do not use any cleaning sprays - only wipe down with damp cloth or rub with dry cloth. (Do not use an abrasive cloth as it may scratch the plastic).

Do not use harsh chemical cleaners as these can break down the plastic and cause it to crack.

BESMOKEY10 Smoke Alarms come with a 10 Year Warranty from date of purchase. BESMOKEY10 Accessories are warranted for 7 Years from date of purchase. Proof of Purchase is required for Warranty Claims

– please see www.gsme.com.au for details regarding warranty claims.

Bear Photoelectric Smoke Alarm Wireless (Non Removable) Lithium Battery Only



BESMOKEY10BW can be used with BESMOKEY10REM.

BESMOKEY10BW is also net-workable with BESMOKEY10 with BESMOKEY10WM INSTALLED.

Example of a network using BESMOKEY10BW and BESMOKEY10 combined with hard wired and interconnected (using cable) with a single "master" alarm with the BESMOKEY10MW module fitted communicating with others in the system that are operating from the 10 Year Lithium battery.

NETWORK CONFIGURATION EXAMPLE

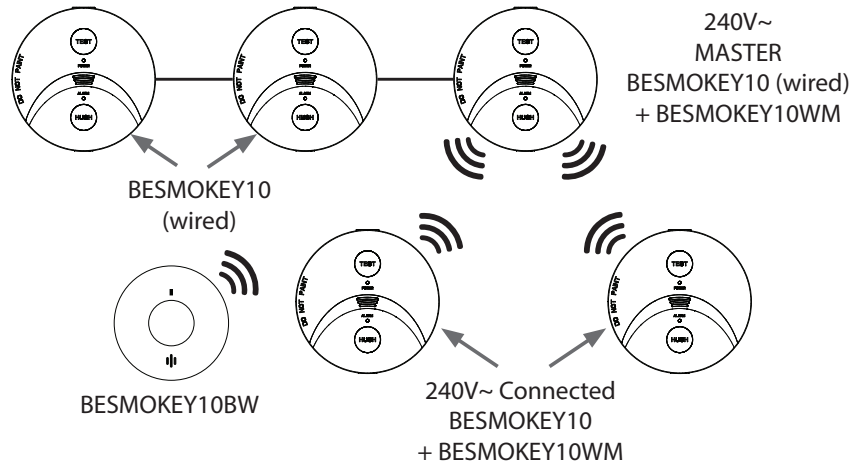

BESMOKEYREM can be installed on wireless network for convenient control.



Certification Number:
Active Fire: afp-3735

GSM Electrical (Australia) Pty Ltd
Level 2, 142-144 Fullarton Road, Rose Park SA 5067
P: 1300 301 838 F: 1300 301 778 E: service@gsme.com.au
www.gsme.com.au



Data Specification Sheet
October 2022

BESMOKEY10

*See current catalogue for further detail



Page 1 of 2

Cleaning Guide:

Spraying cleaning products on to electrical products is not recommended. It is important to ensure that switches are turned off before cleaning.

Do not use any cleaning sprays - only wipe down with damp cloth or rub with dry cloth. (Do not use an abrasive cloth as it may scratch the plastic).

Do not use harsh chemical cleaners as these can break down the plastic and cause it to crack.

BESMOKEY10 Smoke Alarms come with a 10 Year Warranty from date of purchase. BESMOKEY10 Accessories are warranted for 7 Years from date of purchase. Proof of Purchase is required for Warranty Claims

– please see www.gsme.com.au for details regarding warranty claims.

Bear Photoelectric Smoke Alarm Wireless Ready

- Photoelectric Sensing Technology.
- Activfire Listed.
- Complies with AS3786:2014.
- Main power source 220-240 V AC 50 Hz.
- Secondary power source DC 3V battery 10 Year Lithium.
- Interconnection Max. 24 alarms (wired 150m maximum).
- Wireless upgradeable by clipping in BESMOKEY10WM and linking with other alarms that also contain the module.
- 4 hard wired Terminals that accommodate 2 x 2.5mm² (A, E-Loop, N, I-connect) for hard wired applications.
- Surface Mount Base Plate with Large Cable Terminals.
- Suitable for Ceiling or Wall Mounting.
- Alarm volume ≥ 85dB(A) @ 3m complying with ISO8201 alarm pattern.
- Operating Temperature 0 °C to 40 °C.
- Maximum humidity for installation: 5-95% Relative Humidity.
- Red LED Alarm Status Indication.
- Green LED AC Mains Power Indication.
- Separate test and Hush Buttons to assist with wireless linking.
- Insect Screen protects Sensing Chamber.
- Sleek Styling.
- The BESMOKEY10 with BESMOKEY10WM can also pair to BESMOKEY10BW 10 Year Lithium Wireless Smoke Alarm.
- 10 Year warranty.

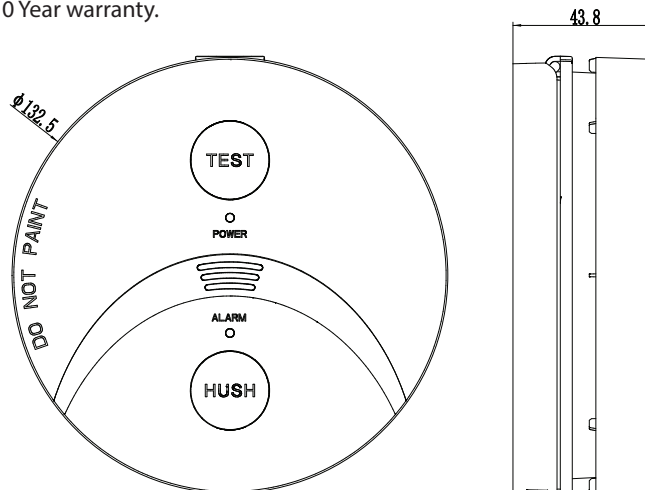

Catalogue Number	Description
BESMOKEY10	Smoke Alarm Photoelectric Surface Mount 220-240V AC 3V DC Lithium 10 Year Battery Wireless Interconnect Ready 4 Terminals

Certification Number:
Active Fire: afp-3688

GSM Electrical (Australia) Pty Ltd
Level 2, 142-144 Fullarton Road, Rose Park SA 5067
P: 1300 301 838 F: 1300 301 778 E: service@gsme.com.au
www.gsme.com.au



Data Specification Sheet
October 2022



BESMOKEY10

*See current catalogue for further detail



Page 2 of 2

Cleaning Guide:

Spraying cleaning products on to electrical products is not recommended. It is important to ensure that switches are turned off before cleaning.

Do not use any cleaning sprays - only wipe down with damp cloth or rub with dry cloth. (Do not use an abrasive cloth as it may scratch the plastic).

Do not use harsh chemical cleaners as these can break down the plastic and cause it to crack.

BESMOKEY10 Smoke Alarms come with a 10 Year Warranty from date of purchase. BESMOKEY10 Accessories are warranted for 7 Years from date of purchase. Proof of Purchase is required for Warranty Claims – please see www.gsme.com.au for details regarding warranty claims.

Bear Photoelectric Smoke Alarm Wireless Ready

Making BESMOKEY10 Wireless:

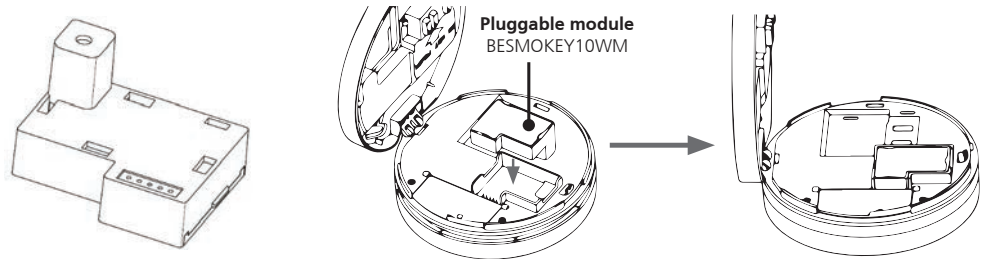

To make wireless, before removing battery tag add BESMOKEY10MW, then connect battery and power. Follow instruction to pair the wireless alarms in the network.

Example of a network using BESMOKEY10 combined with hard wired and interconnected (using cable) with a single “master” alarm with the BESMOKEY10MW module fitted communicating with others in the system that are operating from the 10 Year Lithium battery.

NETWORK CONFIGURATION EXAMPLE

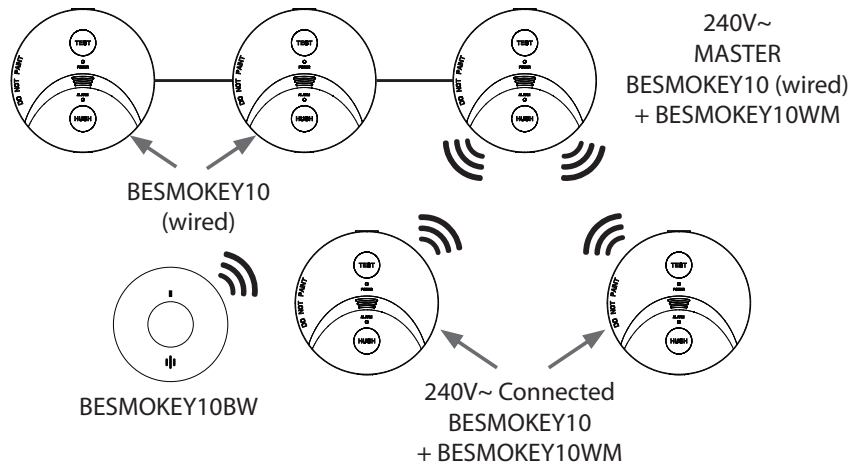

BESMOKEYREM can be installed on wireless network for convenient control.



Certification Number:
Active Fire: afp-3688

GSM Electrical (Australia) Pty Ltd
Level 2, 142-144 Fullarton Road, Rose Park SA 5067
P: 1300 301 838 F: 1300 301 778 E: service@gsme.com.au
www.gsme.com.au



Data Specification Sheet
October 2022

BESMOKEY10WM

*See current catalogue for further detail



Cleaning Guide:

Spraying cleaning products on to electrical products is not recommended. It is important to ensure that switches are turned off before cleaning.

Do not use any cleaning sprays - only wipe down with damp cloth or rub with dry cloth. (Do not use an abrasive cloth as it may scratch the plastic).

Do not use harsh chemical cleaners as these can break down the plastic and cause it to crack.

BESMOKEY10 Smoke Alarms come with a 10 Year Warranty from date of purchase. BESMOKEY10 Accessories are warranted for 7 Years from date of purchase. Proof of Purchase is required for Warranty Claims

– please see www.gsme.com.au for details regarding warranty claims.

BESMOKEY10WM Wireless Module

- Application: Suitable for TRADER BESMOKEY10 220-240V a.c. smoke alarm .
- Wireless Distance: >60m (clear line of sight).
- Frequency: 433.42MHz.
- Interconnection capacity: Maximum 40 devices .
- Size: 45 x 35 x 26mm.
- Temp range: 0°C - 45°C .
- Max Humidity: 5-95%RH.
- Wireless module complies with AS/NZS4268.
- Alarm Signal Pattern when installed in BESMOKEY10: ISO 8201 and AS 3786:2014 compliant Introducing Wireless Alarm Option into the network with the BESMOKEY1 0WM module.
- This module can be installed into the BESMOKEY10 by first disconnecting the power and opening one of the mains powered alarms, do this before removing the yellow tag for the battery, replace the blank housing with the BESMOKEY10WM wireless module then remove battery tag to connect power.
- The BESMOKEY10WM communicates at 433.42MHz and can operate at range greater than 60m.
- With the power off select one mains wired alarm to be the master for the wireless link and install the BESMOKEY10WM.
- The BESMOKEY10 with BESMOKEY10WM can also pair to BESMOKEY10BW 10 Year Lithium Wireless Smoke Alarm.

Caution: Only install one pluggable BESMOKEY10WM module into a group of mains-wired interconnected alarms. If there is more than one installed with wired connections, it will not work. Follow the instructions provided to pair the wireless alarms in the network.

Making BESMOKEY10 Wireless:

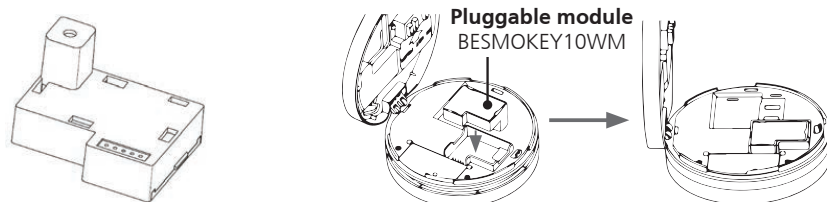

To make wireless, before removing battery tag add BEMOKEY10MW, then connect battery and power. Follow instruction to pair the wireless alarms in the network.

Example of a network using BESMOKEY10 combined with hard wired and interconnected (using cable) with a single “master” alarm with the BESMOKEY10WM module fitted communicating with others in the system that are operating from the 10 Year Lithium battery.

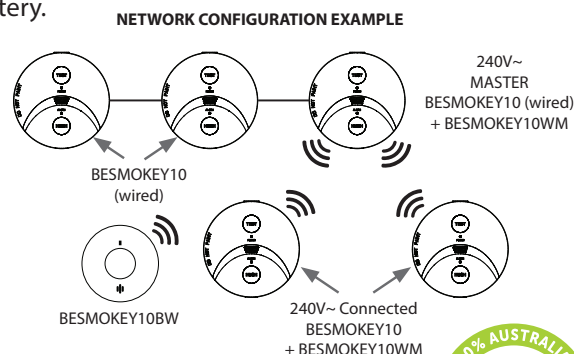

Certification Number:

Active Fire: afp-3688 with BESMOKEY10

GSM Electrical (Australia) Pty Ltd

Level 2, 142-144 Fullarton Road, Rose Park SA 5067

P: 1300 301 838 F: 1300 301 778 E: service@gsme.com.au

www.gsme.com.au



BESMOKEY10REM

*See current catalogue for further detail



Cleaning Guide:

Spraying cleaning products on to electrical products is not recommended. It is important to ensure that switches are turned off before cleaning.

Do not use any cleaning sprays - only wipe down with damp cloth or rub with dry cloth. (Do not use an abrasive cloth as it may scratch the plastic).

Do not use harsh chemical cleaners as these can break down the plastic and cause it to crack.

BESMOKEY10 Smoke Alarms come with a 10 Year Warranty from date of purchase. BESMOKEY10 Accessories are warranted for 7 Years from date of purchase. Proof of Purchase is required for Warranty Claims

– please see www.gsme.com.au for details regarding warranty claims.



Bear Smoke Alarm Wireless Remote for BESMOKEY10 with Wireless Module (BESMOKEY10WM) installed and BESMOKEY10BW

- Works with the BESMOKEY10 with Wireless Module (BESMOKEY10WM) installed and also BESMOKEY10BW.
- Complies with AS/NZS 4268.
- Power source DC 3V (CR2450) Lithium Button Battery.
- Wireless distance > 5 meters depending on surroundings.
- 433.42MHz Wireless frequency.
- Size 53.1mm x 61.9 mm x 16.3mm.
- Interconnection Max. 40 devices.
- Humidity Range $\leq 95\%$ relative humidity (RH).
- Standby current $\leq 3\mu\text{A}$ Operation.
- Current $\leq 30\text{mA}$.
- Operating temperature 0~45°C.
- "Test" button sends the test alarm signal to the smoke alarm.
- "Locate" button detected the smoke alarm is sounding and operating in the alarm status.
- "Hush" button locates the alarm that has initiated the alarm mode situation and hush the smoke alarm for 10 minutes.
- "SOS" button to activate the alarm network and use them to alert people to a non-fire-related emergency.
- 10 year Battery Lifetime.

Warning:

The BESMOKEY10REM is not a toy and should be used carefully. Do not immerse in water or liquids.

The product contains a Lithium button battery that is hazardous and should be kept away from children. The batter may cause fatal injury if swallowed and immediate medical attention should be sought.

If the BESMOKEY10REM is not functioning, please ensure the plastic tab has been removed from the battery compartment. If there is a need to change the battery for any reason, do not handle the battery surfaces with fingers as this may affect the performance as shown below.

Changing the Battery:

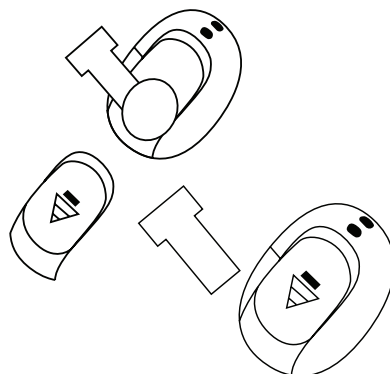

GSM Electrical (Australia) Pty Ltd

Level 2, 142-144 Fullarton Road, Rose Park SA 5067
P: 1300 301 838 F: 1300 301 778 E: service@gsme.com.au
www.gsme.com.au



Battery Warranty



Data Specification Sheet
October 2022

**BESMOKEY4
BESMOKEY4BK
BESMOKEY4SK
BESMOKEY4SKBK**



Cleaning Guide:

Spraying cleaning products on to electrical products is not recommended. It is important to ensure that switches are turned off before cleaning.

Do not use any cleaning sprays - only wipe down with damp cloth or rub with dry cloth. (Do not use an abrasive cloth as it may scratch the plastic).

Do not use harsh chemical cleaners as these can break down the plastic and cause it to crack.

Do not wash the cover plates in water over 60°C.

Photoelectric Smoke Alarm with Hinged Base Plate, 4 Terminals

- **Operate as Single or Inter-connect up to 24 units**
Operation: This smoke alarm operates as a single unit and/or interconnects up to 24 other units. *This smoke alarm is not designed to be interconnected with other products or accessories unless specified.*
- Photoelectric Sensing Technology
- Activfire Listed
- Tested and Approved to AS3786:2014
- 240V~ AC with 9V DC Battery Backup
- Surface Mount Base Plate with Large Cable Terminals
- Suitable for Ceiling or Wall Mounting
- Fits BESMOKEY4SK Skirt to replace larger detectors and not leave paint marks
- Available in white or black - please check availability
- Red LED Alarm Status Indication
- Green LED AC Mains Power Indication
- Loud 85dBA Warning Siren
- Repeat 3 Long Beeps (ISO 8201) Indicated that particles of combustion have been detected
- Single Test and Hush Button
- Warning for Low Battery
- Anti-Tamper Feature
- Insect Screen protects Sensing Chamber
- Sleek Styling
- 10 year warranty (does not include battery)

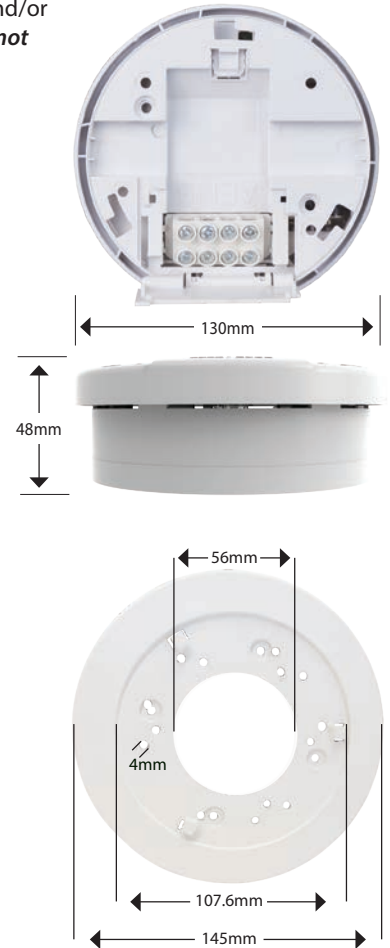

Smoke Alarm Skirt

- Perfect for covering miss matched paint marks from old smoke detectors
- Covers Ø145mm
- 80mm & 83.5mm Hole Centres

Detector needs to have base wired prior to installing skirt



Simply push and rotate BESMOKEY4 Smoke Alarm into place

Certification Number:

XF3339/R1
XF3229/R1

GSM Electrical (Australia) Pty Ltd

Level 2, 142-144 Fullarton Road, Rose Park SA 5067
P: 1300 301 838 F: 1300 301 778 E: service@gsme.com.au
www.gsme.com.au

