





## Main

Range	TeSys TeSys Deca
Product name	TeSys D TeSys Deca
Product or component type	Reversing contactor
Device short name	LC2D
Contactor application	Motor control Resistive load
Utilisation category	AC-1 AC-3
Device presentation	Preassembled with reversing power busbar
Poles description	3P
Power pole contact composition	3 NO
[Ue] rated operational voltage	Power circuit: ≤ 690 V AC 25...400 Hz Power circuit: ≤ 300 V DC
[Ie] rated operational current	40 A (at <60 °C) at ≤ 440 V AC AC-3 for power circuit 60 A (at <60 °C) at ≤ 440 V AC AC-1 for power circuit
Motor power kW	18.5 kW at 380...400 V AC 50 Hz 11 kW at 220...230 V AC 50 Hz 22 kW at 415...440 V AC 50 Hz 22 kW at 500 V AC 50 Hz 30 kW at 660...690 V AC 50 Hz
Motor power HP (UL / CSA)	5 Hp at 230/240 V AC 60 Hz for 1 phase motors 10 Hp at 230/240 V AC 60 Hz for 3 phases motors 30 Hp at 575/600 V AC 60 Hz for 3 phases motors 10 Hp at 200/208 V AC 60 Hz for 3 phases motors 3 Hp at 115 V AC 60 Hz for 1 phase motors 30 hp at 460/480 V AC 60 Hz for 3 phases motors
Control circuit type	AC at 50/60 Hz
[Uc] control circuit voltage	220 V AC 50/60 Hz
Auxiliary contact composition	1 NO + 1 NC
[Uimp] rated impulse withstand voltage	6 kV conforming to IEC 60947
Overvoltage category	III
[Ith] conventional free air thermal current	10 A (at 60 °C) for signalling circuit 60 A (at 60 °C) for power circuit
Irms rated making capacity	140 A AC for signalling circuit conforming to IEC 60947-5-1 250 A DC for signalling circuit conforming to IEC 60947-5-1 800 A at 440 V for power circuit conforming to IEC 60947
Rated breaking capacity	800 A at 440 V for power circuit conforming to IEC 60947
[Icw] rated short-time withstand current	72 A 40 °C - 10 min for power circuit 165 A 40 °C - 1 min for power circuit 320 A 40 °C - 10 s for power circuit 720 A 40 °C - 1 s for power circuit 100 A - 1 s for signalling circuit 120 A - 500 ms for signalling circuit 140 A - 100 ms for signalling circuit
Associated fuse rating	10 A gG for signalling circuit conforming to IEC 60947-5-1 80 A gG at ≤ 690 V coordination type 1 for power circuit 80 A gG at ≤ 690 V coordination type 2 for power circuit
Average impedance	1.5 mOhm - Ith 60 A 50 Hz for power circuit

[Ui] rated insulation voltage	Power circuit: 690 V conforming to IEC 60947-4-1 Power circuit: 600 V CSA certified Power circuit: 600 V UL certified Signalling circuit: 690 V conforming to IEC 60947-1 Signalling circuit: 600 V CSA certified Signalling circuit: 600 V UL certified
Electrical durability	1.5 Mcycles 40 A AC-3 at $U_e \leq 440$ V 1.4 Mcycles 60 A AC-1 at $U_e \leq 440$ V
Power dissipation per pole	2.4 W AC-3 5.4 W AC-1
Front cover	With
Interlocking type	Mechanical
Mounting support	Rail Plate
Standards	CSA C22.2 No 14 EN 60947-4-1 EN 60947-5-1 IEC 60947-4-1 IEC 60947-5-1 UL 508 IEC 60335-1
Product certifications	UL CSA RINA GOST CCC DNV LROS (Lloyds register of shipping) GL BV UKCA
Connections - terminals	Control circuit: screw clamp terminals 1 cable(s) 1... 4 mm <sup>2</sup> flexible without cable end Control circuit: screw clamp terminals 2 cable(s) 1... 4 mm <sup>2</sup> flexible without cable end Control circuit: screw clamp terminals 1 cable(s) 1... 4 mm <sup>2</sup> flexible with cable end Control circuit: screw clamp terminals 2 cable(s) 1... 2.5 mm <sup>2</sup> flexible with cable end Control circuit: screw clamp terminals 1 cable(s) 1... 4 mm <sup>2</sup> solid Control circuit: screw clamp terminals 2 cable(s) 1... 4 mm <sup>2</sup> solid Power circuit: EverLink BTR screw connectors 1 cable(s) 1...35 mm <sup>2</sup> flexible without cable end Power circuit: EverLink BTR screw connectors 2 cable(s) 1...25 mm <sup>2</sup> flexible without cable end Power circuit: EverLink BTR screw connectors 1 cable(s) 1...35 mm <sup>2</sup> flexible with cable end Power circuit: EverLink BTR screw connectors 2 cable(s) 1...25 mm <sup>2</sup> flexible with cable end Power circuit: EverLink BTR screw connectors 1 cable(s) 1...35 mm <sup>2</sup> solid Power circuit: EverLink BTR screw connectors 2 cable(s) 1...25 mm <sup>2</sup> solid
Tightening torque	Control circuit: 1.7 N.m - on screw clamp terminals - with screwdriver flat Ø 6 mm Control circuit: 1.7 N.m - on screw clamp terminals - with screwdriver Philips No 2 Power circuit: 8 N.m - on EverLink BTR screw connectors - cable 25...35 mm <sup>2</sup> hexagonal screw head 4 mm Power circuit: 5 N.m - on EverLink BTR screw connectors - cable 1...25 mm <sup>2</sup> hexagonal screw head 4 mm Control circuit: 1.7 N.m - on screw clamp terminals - with screwdriver pozidriv No 2 Power circuit: 2.5 N.m - on screw clamp terminals - with screwdriver pozidriv No 2
Operating time	4...19 ms opening 12...26 ms closing
Safety reliability level	B10d = 1369863 cycles contactor with nominal load conforming to EN/ISO 13849-1 B10d = 2000000 cycles contactor with mechanical load conforming to EN/ISO 13849-1

Mechanical durability	6 Mcycles
Maximum operating rate	3600 cyc/h 60 °C

## Complementary

Coil technology	Without built-in suppressor module
Control circuit voltage limits	0.3...0.6 Uc (-40...70 °C):drop-out AC 50/60 Hz 0.8...1.1 Uc (-40...60 °C):operational AC 50 Hz 0.85...1.1 Uc (-40...60 °C):operational AC 60 Hz 1...1.1 Uc (60...70 °C):operational AC 50/60 Hz
Inrush power in VA	140 VA 60 Hz cos phi 0.75 (at 20 °C) 160 VA 50 Hz cos phi 0.75 (at 20 °C)
Hold-in power consumption in VA	13 VA 60 Hz cos phi 0.3 (at 20 °C) 15 VA 50 Hz cos phi 0.3 (at 20 °C)
Heat dissipation	4...5 W at 50/60 Hz
Auxiliary contacts type	Type mechanically linked 1 NO + 1 NC conforming to IEC 60947-5-1 Type mirror contact 1 NC conforming to IEC 60947-4-1
Signalling circuit frequency	25...400 Hz
Minimum switching current	5 mA for signalling circuit
Minimum switching voltage	17 V for signalling circuit
Non-overlap time	1.5 Ms on de-energisation between NC and NO contact 1.5 ms on energisation between NC and NO contact
Insulation resistance	> 10 MOhm for signalling circuit

## Environment

IP degree of protection	IP20 front face conforming to IEC 60529
Climatic withstand	Conforming to IACS E10 Conforming to IEC 60947-1 Annex Q category D
Protective treatment	TH conforming to IEC 60068-2-30
Pollution degree	3
Ambient air temperature for operation	-40...60 °C 60...70 °C with derating
Ambient air temperature for storage	-60...80 °C
Operating altitude	0...3000 m
Fire resistance	850 °C conforming to IEC 60695-2-1
Flame retardance	V1 conforming to UL 94
Mechanical robustness	Vibrations contactor open: 2 Gn, 5...300 Hz Vibrations contactor closed: 4 Gn, 5...300 Hz Shocks contactor open: 10 Gn for 11 ms Shocks contactor closed: 15 Gn for 11 ms
Height	122 mm
Width	119 mm
Depth	120 mm
Net weight	1.87 kg

## Packing Units

Unit Type of Package 1	PCE
Number of Units in Package 1	1
Package 1 Weight	2.052 kg
Package 1 Height	14 cm
Package 1 width	16.2 cm
Package 1 Length	19.8 cm
Unit Type of Package 2	S03
Number of Units in Package 2	4
Package 2 Weight	8.754 kg
Package 2 Height	30 cm
Package 2 width	30 cm
Package 2 Length	40 cm
Package 3 Height	77 cm

## Offer Sustainability

Sustainable offer status	Green Premium product
REACH Regulation	<a href="#">REACH Declaration</a>
REACH free of SVHC	Yes
EU RoHS Directive	Compliant <a href="#">EU RoHS Declaration</a>
Toxic heavy metal free	Yes
Mercury free	Yes
RoHS exemption information	<a href="#">Yes</a>
China RoHS Regulation	<a href="#">China RoHS Declaration</a>
Environmental Disclosure	<a href="#">Product Environmental Profile</a>
Circularity Profile	<a href="#">End Of Life Information</a>
WEEE	The product must be disposed on European Union markets following specific waste collection and never end up in rubbish bins
PVC free	Yes

## Contractual warranty

Warranty	18 months
----------	-----------

Dimensions

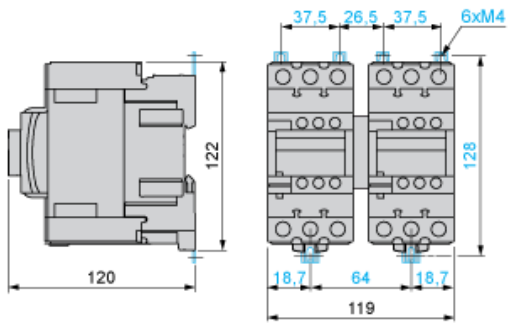

Wiring

