



Ocean Emergency



The Ocean is a surface-mount tri-colour LED oyster light perfect for corridors and common areas. Available in non-emergency, emergency and self-testing. Optional Beacon & sensor modules available for energy-saving applications.



Features

-  1,785 Lumens
-  Tri-Colour
-  LiFe PO⁴ Lithium Battery

Accessories

-  BEACON-MODULE
-  SENSOR-MODULE



ORDER CODE	OCEAN-TRI-EM	OCEAN-TRI-ST	OCEAN-TRI-LR
WARRANTY	3 Years	5 Years	5 Years
TRADITIONAL DROP TEST	✓	✓	✓
APP SCHEDULED TESTING		✓	✓
REMOTE SCHEDULED TESTING			✓



Download the Elumen app



Device Specifications

OPERATIONAL INFORMATION

VOLTAGE	220 - 240VAC
FREQUENCY	50Hz
LUMINOUS FLUX	1785lm (Standard Mode) 290lm (Emergency Mode)
POWER CONSUMPTION	24W
AMBIENT TEMPERATURE	1°C - 40°C
IP RATING	IP20
COLOUR TEMPERATURE	3,000°k/4,000°k/5,000°k
MOUNTING TYPE	Surface Ceiling Mount
OPERATING MODE	Maintained, Non-Maintained, Switch Controlled
PROJECTED LED LIGHT SOURCE LIFE	100,000 Hours

CONSTRUCTION, DIMENSIONS AND WEIGHT

CONSTRUCTION	Poly Carbonate Diffuser & Powder Coated Steel Body
WEIGHT	1.3kg
CARTON QTY	5
CARTON DIMENSIONS	630mm x 410mm x 410mm
CARTON WEIGHT	9.5kg

COMPLIANCE AND TESTING

STANDARDS	AS/NZS 2293.3 AS/NZS 60598.2.22 AS/NZS CISPR 15
EMERGENCY CLASSIFICATION	C0:D32 C90:D32

Product Drawing

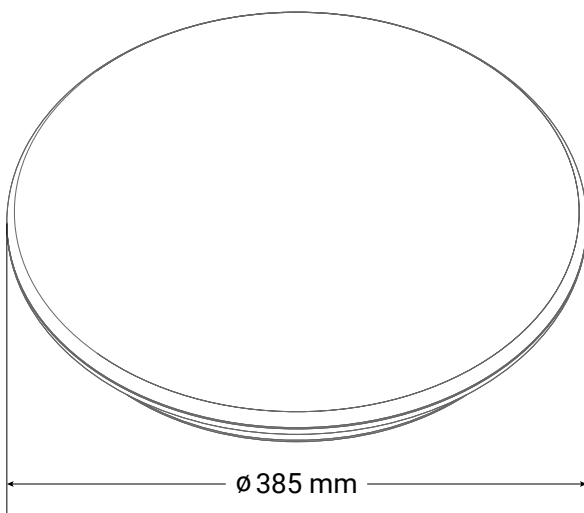

ORTHOGRAPHIC DRAWING

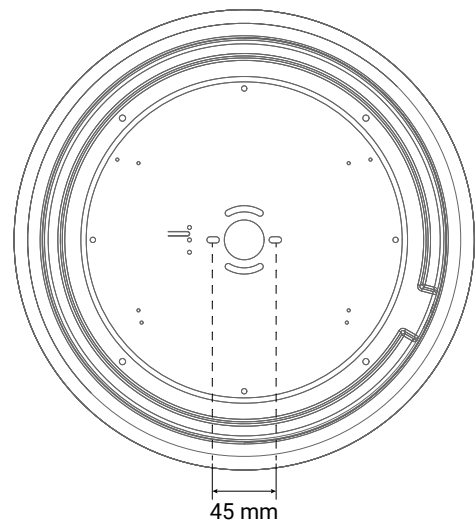

MOUNTING INFORMATION