

# LIVING now



TRADITIONAL  
CONTROL



CONTROL WITH  
SMARTPHONE



VOICE  
COMMAND



SCHEDULING

**bticino**



# CONTENTS

DESIGN INNOVATION	6
NEW DIGITAL CONTROLS	8
FINISHES	10
THE SOLUTION FOR ALL SYSTEM REQUIREMENTS	16
SMART ELECTRONIC SYSTEM	18
HOME+CONTROL	22
INSTALLATION	28
HOME AUTOMATION THAT SPEAKS	34
HOME AUTOMATION LIKE NEVER BEFORE	36
INSTALLATION OF DIGITAL CONTROLS	40
ALWAYS PERFECT INSTALLATION	44
CATALOGUE	48

# LIVING now



Forever an icon,  
today smart as well.

Living Now is the new Living generation. A timeless icon which combines the linearity of a unique design with the simplicity of smart technology. All this without changing wiring procedures because Living Now is installed in the traditional way, guaranteeing a perfect installation.



Traditional  
control



Control with  
smartphone



Voice  
command



Scheduling

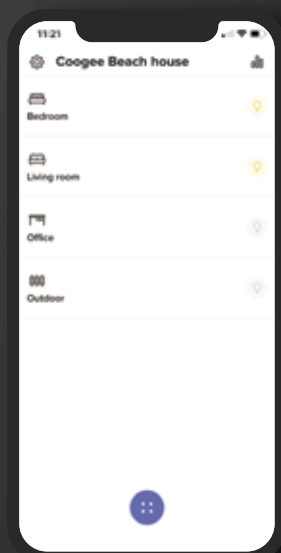

- **Innovative design:** revisited relationship between cover plate and functions.
- **Smart:** the first intrinsically connected wiring devices range!
- The best technical solutions for a **perfect installation.**



App  
Home + Control



# DESIGN INNOVATION

**PERFECTLY FLUSH WITH  
ELEGANT DETAILS**



Living Now, has won this prestigious international award confirming BTicino's ability to combine technology and design

### FULL TOUCH CONTROLS

The light can be switched on or off by pressing any point the keys surface. After being pressed, the keys return to their original position, perfectly aligned.



### MORE SPACE FOR FUNCTIONS

Unique shape with increased space for functions

# NEW DIGITAL CONTROLS WITH LIVING NOW FINISH

Living Now series digital controls are now part of the MyHOME\_Up automation range. A mix of incomparable innovation and simplicity, ready to be discovered, heard and touched.



## **VOICE CONTROL**

Device with built-in Amazon Alexa assistant, ideal for voice control of the MyHOME\_Up home automation functions.





### **LIGHT AND FULL CONTROLS**

- New touch controls without cover plate
- Customised icons and leds using the app MyHOME\_Up
- Expandable to new functions

# DEVICE FINISHES

— WHITE



— BLACK





## 2 COLOUR OPTIONS

Each device features an aesthetic component, its covers which are available in two colours: white and black, each featuring a pleasant satin finish.

## COVER PLATES

The Living Now cover plate range includes 12 finishes, made from a range of designer materials including techno polymer metal and wood.



## MYHOME\_UP DIGITAL CONTROLS

MyHOME\_Up digital controls do not require the use of cover plates and are available in white and black.



# COVER PLATE FINISHES



**ICE cover plate**  
Material: techno polymer  
Code: ...DW





The zamak and wood finishes are obtained using sustainable production procedures. Each coverplate is unique and features distinguishable features making them one-of-a-kind.



**GOLD cover plate**

Material: zamak  
Code: ...ZW



**MOON COVER PLATE**

Material: zamak  
Code: ...NW



**SKY cover plate**

Material: techno polymer  
Code: ...DA



**PIXEL cover plate**

Material: techno polymer  
- pixel effect  
Code: ...MW



**OAK cover plate**

Material: wood  
Code: ...LM

# COVER PLATE FINISHES



**STEEL cover plate**  
Material: zamak  
Code: ...ZG





The zamak and wood finishes are obtained using sustainable production procedures. Each coverplate is unique and features distinguishable features making them one-of-a-kind.



**BLACK cover plate**

Material: techno polymer  
Code: ...KG



**SPACE cover plate**

Material: zamak  
Code: ...NG



**WALNUT cover plate**

Material: wood  
Code: ...LG



**NIGHT cover plate**

Material: techno polymer  
Code: ...DG

THE RIGHT SOLUTION FOR ALL NEEDS

# SMART ELECTRICAL SYSTEM

Living Now <sup>WITH</sup> Netatmo

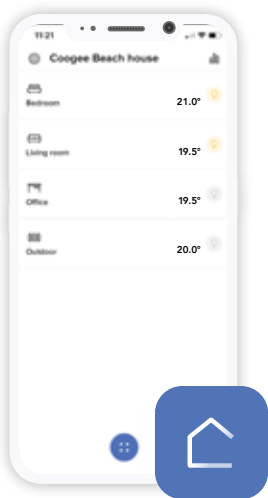

App HOME + CONTROL

## INSTALLATION WITH TRADITIONAL WIRING

Install a traditional electrical system and enjoy SMART functions by connecting it to a home Wi-Fi network. Use the HOME + CONTROL App on a smart device to control lights, small appliances and shutters and more.

### FUNCTIONS

- Lights
- Shutters
- Sockets
- Temperature control
- Scenario control
- Consumption display
- Load shedding control
- Planning programmed

### CHOOSE HOW TO CONTROL IT

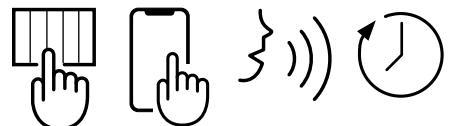



LIVING  
**now**

# HOME AUTOMATION SYSTEM

Living Now MyHOME\_Up

 alexa built-in

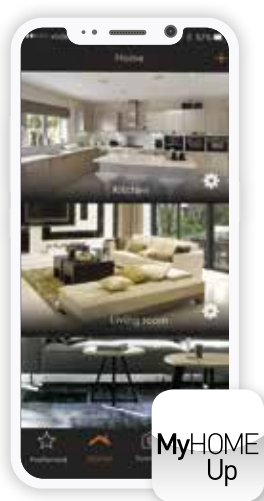

App MyHOME\_Up

## INSTALLATION WITH BUS

Create a BUS integrated system manageable from the MyHOME\_UP App, using voice or the Touch Screen controls.

### FUNCTIONS

- Lights
- Shutters
- Sockets
- Temperature control
- Scenario control
- Consumption display
- Load shedding control
- Burglar alarm
- Video door entry system
- NUVO sound diffusion system
- Integration with other brand.

### CHOOSE HOW TO CONTROL IT



# SMART ELECTRICAL SYSTEM

Check in on your home just like you would for your emails or bank account. Enjoy the convenience of complete home control right at your finger tips.

App  
HOME + CONTROL

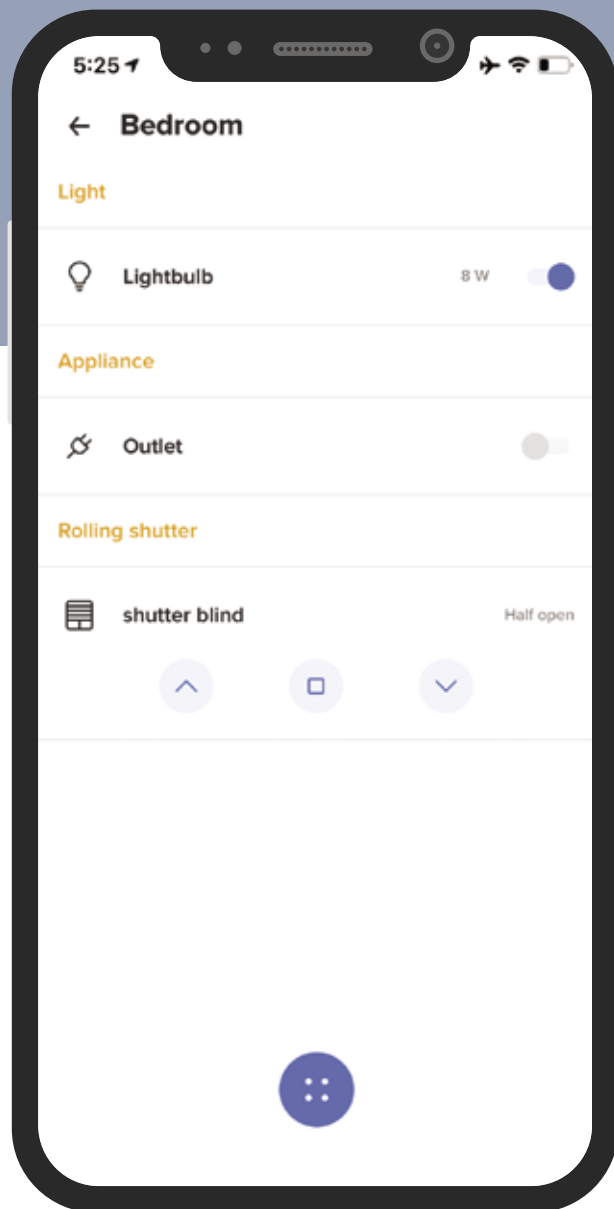

**GENERAL CONTROL**

With one single click, a general control will allow you to switch off lights and lower all the shutters when you leave home, or activate your favourite scenario.



**CONTROL WITH SMARTPHONE**

From your smartphone, you will be able to view and check the status of lights, shutters and connected power sockets from anywhere.

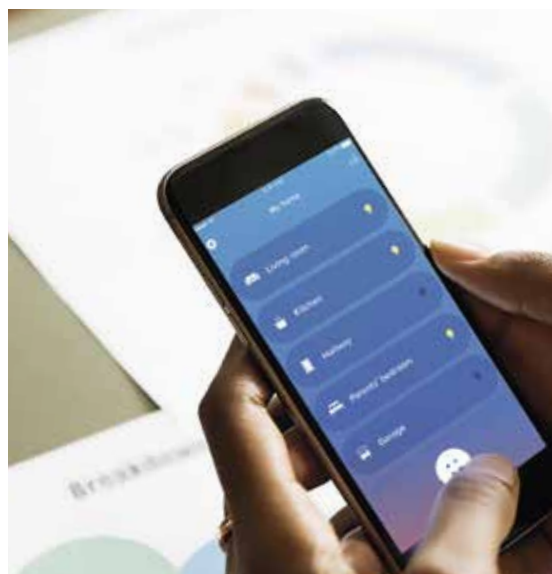

**VOICE COMMAND**

Control your system using your voice via your preferred digital assistant.

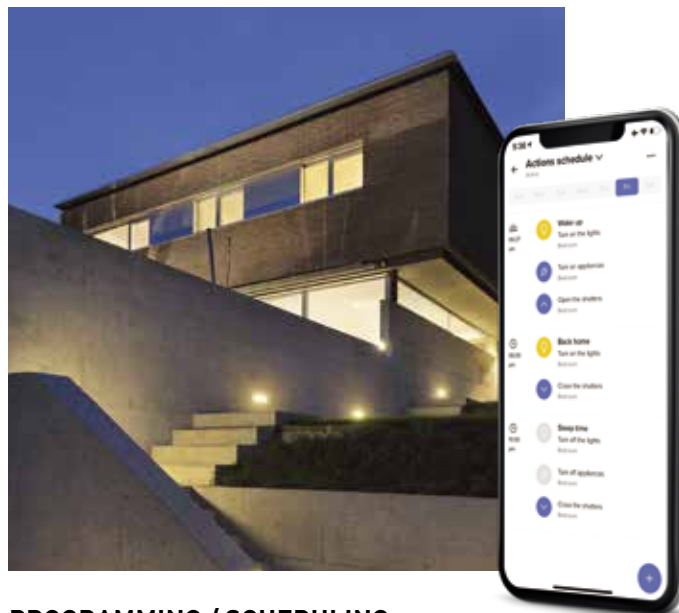
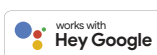

**PROGRAMMING / SCHEDULING**

Program the activation of lights, shutters and loads connected to sockets based on your needs. Appliances:

- automatically switch on the garden lights at sunset and switch them off at sunrise;
- switch on a selection of lights and activate shutters to give the impression you are home while away on holidays.

# Smart electrical system

## TEMPERATURE MANAGEMENT

Remotely check and manage the temperature inside your home using your smartphone via the connected thermostat Smarter with Netatmo.



## LIGHTING AT THE DESIRED LEVEL

Adjust the light level for optimum personal comfort. You can do that from the connected Dimmer, the associated wireless controls and Smartphone, using the Home+Control App.

**LOAD SHEDDING TO AVOID BLACKOUTS**

In overload conditions, the system automatically disconnects the least important load to avoid tripping circuit breakers (blackout).



**ENERGY CONSUMPTION CONTROL**

Use your smartphone to check electricity consumption of your appliances (daily, monthly and yearly).



**WIRELESS CONTROL**

Add wireless controls (lights, shutters and sockets), or reposition them at any time depending on your needs.



**ALARM NOTIFICATIONS**

Receive warning notifications on your smartphone.

# HOME + CONTROL

One single App, many connected advantages



Home+Control is the App that makes it simple to supervise the Living Now Smart system using iOS and Android mobile devices, inside and outside the home.



## WHAT YOUR CUSTOMER CAN DO:

1. Activate and customise **8 scenarios** (4 preconfigured scenarios, coming in, going out, day, night and 4 scenarios customisable by the user);
2. **Display and check the status of lights, shutters, loads connected to sockets and the room temperature;**
3. **Use the Smarter timer thermostat** simply and intuitively;
4. **Check the total home consumptions.**
5. **Receive notifications** on the load and system status;
6. **Define the load priority** for black-out prevention.



## HOME + CONTROL CONFIGURATION IS EASY, BOTH FOR YOU AND YOUR CUSTOMER.

Simply download the App from the Apple or Google store, and follow the guided instructions.

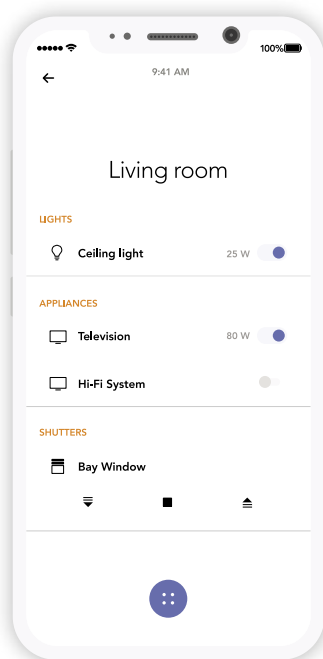

Appliance and load activations

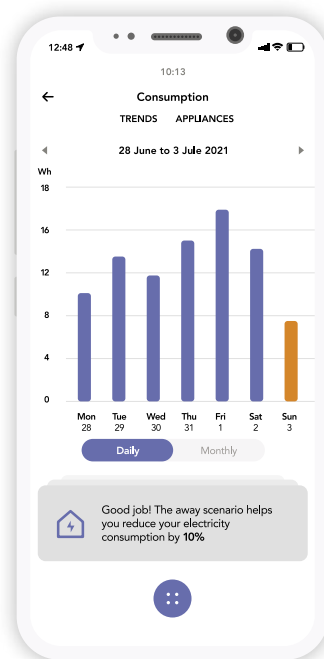

Consumption display

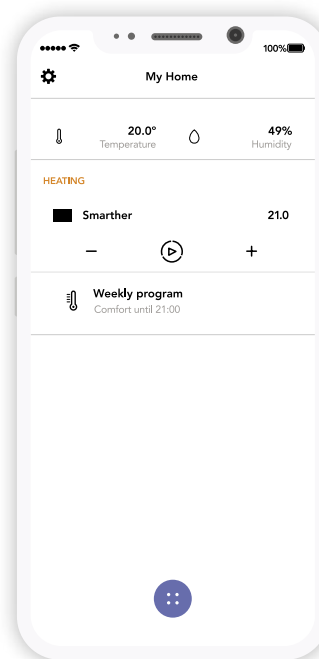

Temperature management

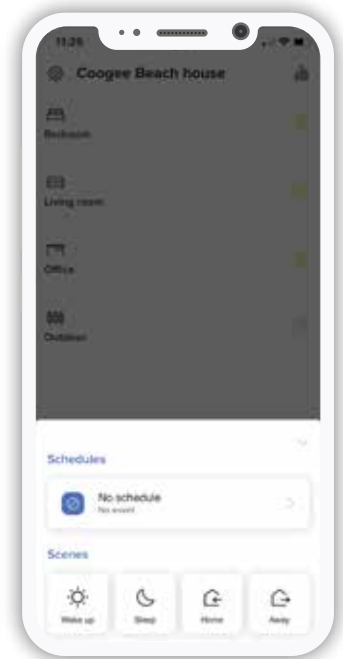

Scenario management

“OK Google,  
set Kitchen light to 100%”

# YOUR CUSTOMERS CAN ALSO MANAGE THEIR HOME WITH THEIR VOICE

With Living Now with Netatmo, your customer will be able to control the system using Apple, Google and Amazon voice assistants. An extremely useful feature, also great for those with mobility problems.



The Gateway connects the system to the Internet via the Home Wi-Fi network.



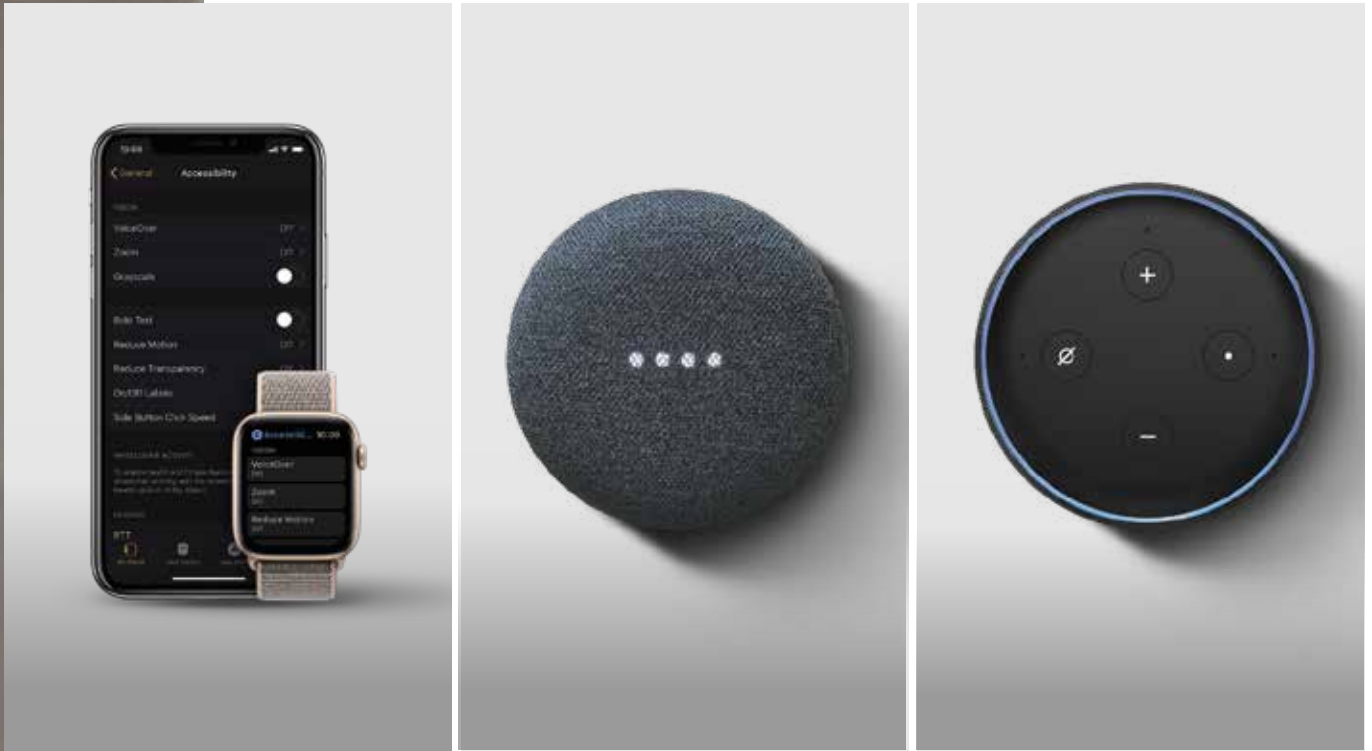

“SIRI, switch the bedroom light on”,  
“OK Google, switch all the home lights off”,  
“ALEXA, set temperature to 20 degrees”.



# Smart electrical system: a simple, rational range of connected devices, both wired and wireless.

## REMOTE CONNECTION

### CONNECTED DEVICES (230V A.C.)

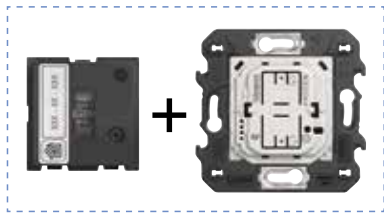

**Cat no. K4500C**  
Gateway with Home/Away wireless switch

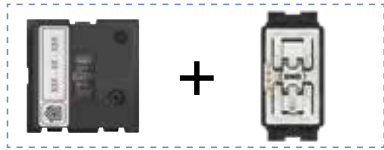

**Cat no. K4510C**  
Gateway with Home/Away wireless switch



**Cat no. 412181**  
Gateway DIN

## SCENARIOS

### BATTERY OPERATED WIRELESS CONTROLS

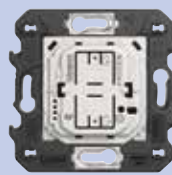

**Cat no. K4570CW**  
Home/Away wireless switch



**Cat no. K4570CWI**  
Home/Away wireless switch



**Cat no. K4575CW**  
4 scenarios control

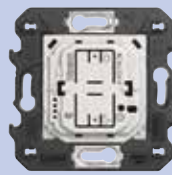

**Cat no. K4574CW**  
Night&Day scenario control



**Cat no. K4574CWI**  
Night&Day scenario control

LIGHTS      SHUTTERS      ENERGY AND CONSUMPTION MANAGEMENT



**Cat no. K4003C**  
Connected  
two-way switch



**Cat no. K4411C**  
Connected  
switch/dimmer



**Cat no. K4027C**  
Connected  
shutter control



**Cat no. K4531C**  
Connected module  
for socket -16 A



**Cat no. 412170**  
Connected DIN  
relay  
16 A



**Cat no. 574243**  
Connected  
light relay  
1,3 A

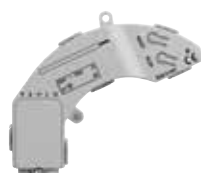

**Cat no. 067697**  
Connected  
micromodule  
for shutter



**Cat no. 412015**  
Connected DIN meter

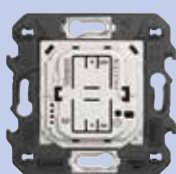

**Cat no. K4003CW**  
Light control



**Cat no. K4003DCW**  
Double  
light control



**Cat no. K4027CW1**  
Shutter control



**Cat no. K4003CWI**  
Light control



**Cat no. 574252**  
Motion  
sensor



**Cat no. 067694**  
Wireless module  
for mechanical  
switch

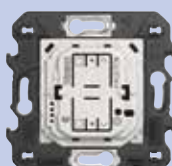

**Cat no. K4027CW**  
Shutter control

Connected thermostat  
**Smarter**



See catalogue for detailed descriptions, availability and full range of products.

# INSTALLED JUST LIKE A TRADITIONAL ELECTRICAL SYSTEM

1.

## DEVICES ARE INSTALLED AND WIRED LIKE TRADITIONAL DEVICES

In lieu of a traditional device, install the connected device of the corresponding type: one for each control point. Remember that the device must always be powered; therefore, ensure that the phase and neutral cables are present. Once installed, the connected control is operational straight away; you will therefore be able to switch the connected light on without the need to do anything further.



EXAMPLE OF A MULTI-WAY SWITCHING  
LIGHT POINT

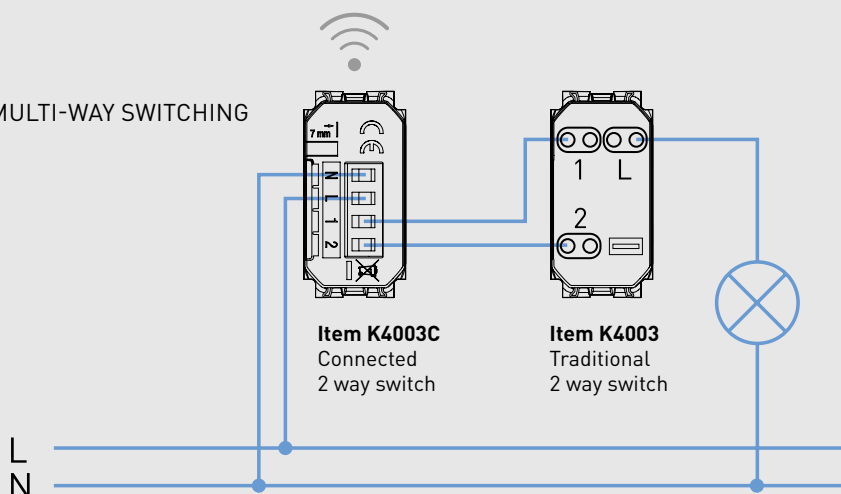

# 2.

## DEVICES CAN BE ASSOCIATED TO EACH OTHER BY SIMPLY PRESSING A PUSHBUTTON

**A.** Power the electrical system

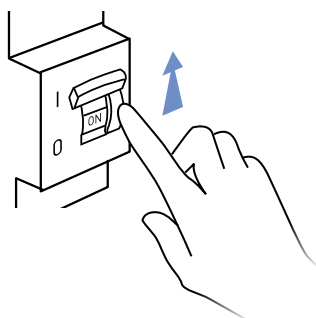

**B.** Simultaneously press both buttons (Home icons) on the wireless master switch for 5 seconds

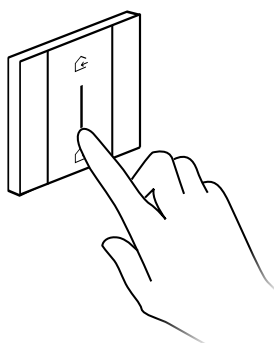

**C.** Devices are associated automatically. You can use the scenario control to activate the going out feature

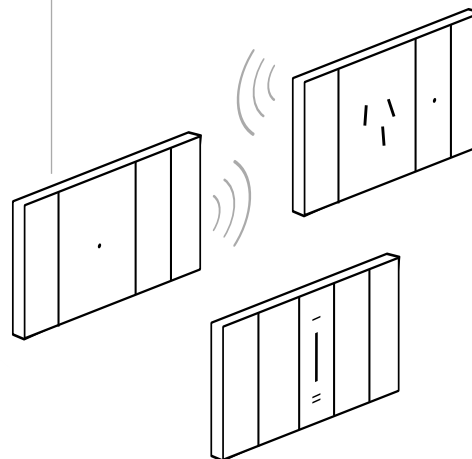

# 3.

## DOWNLOAD THE HOME+CONTROL APP AND FOLLOW THE SETUP ASSISTANT



App Home + Control



## THE SYSTEM MAY BE EXPANDED WITH WIRELESS SWITCHES ASSOCIATED TO THE DEVICES BEING CONTROLLED

**A.** Simultaneously press both buttons (Home icons) on the wireless master switch for 5 seconds

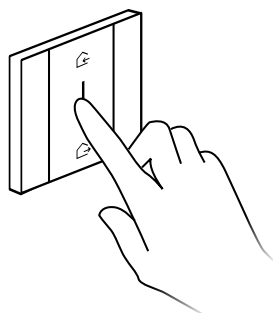

**B.** Place the devices to be associated in contact

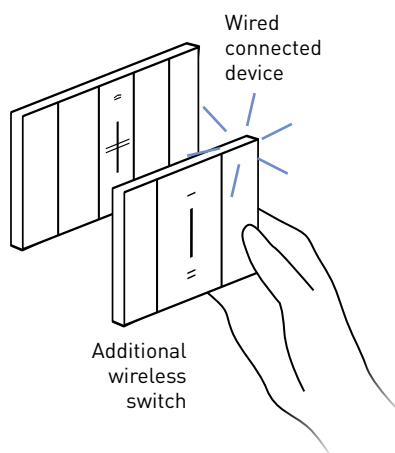

**C.** Install the wireless switch anywhere, based on the needs of your customer

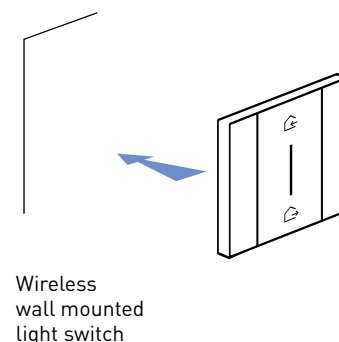



COMING  
SOON

# The **new** connected thermostat **Smarter** WITH **Netatmo**

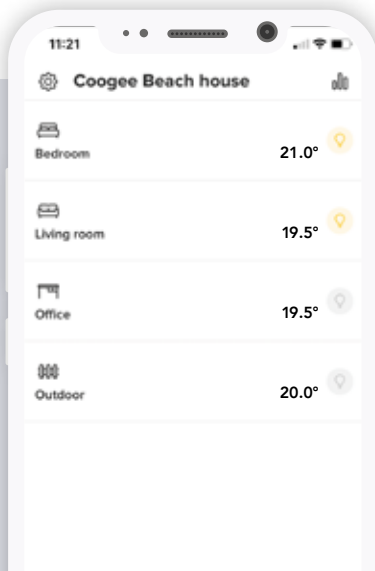

#### WITH THE APP IT'S ALL EASIER

- Remotely manage the thermostat simply and intuitively
- Create and modify weekly programs
- Manage the thermostat from several smartphones and different users
- Control several thermostats in the same home or different homes
- Manage the thermostat updates
- Combine the voice command with your favorite voice assistant (Amazon Alexa, Apple Home Kit or Google Home)

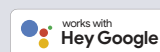
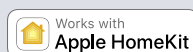

# What can you do with the BTicino connected thermostat?



## SETTING THE PROGRAMS

Using the Home + Control App, it is possible to set preset programs based on habits



## AWAY

If you need to be away from home for a few days you can, via the APP, act remotely to adjust the thermostat (e.g. in antifrost mode) independent of the automatic programming.



## BOOST

The Boost function can be used to activate the heating or cooling system for a limited time (30, 60 or 90 minutes), irrespective of the set program and the ambient temperature.



## MONITORING CONSUMPTIONS

Using the Home + Control App, it is possible to easily manage and monitor consumptions.



## MAXIMUM COMFORT IN EVERY ZONE

Using the same App, it is possible to manage several thermostats in the same home or in different homes.

## The connected thermostat is simple and intuitive



Display the temperature and set it as desired



Display the set room temperature and humidity



Activate the Boost function



LOCAL DEVICE CONTROL



VOICE CONTROL



GEOLOCATION

# INSTALL A MyHOME\_Up SYSTEM USING THE LIVING NOW RANGE



Voice control



Light and Full digital controls

BUS



The range of home automation devices is completed by two innovative Living Now digital controls offering innovative control of your system:

- voice control with built-in Amazon Alexa voice assistant
- Light and Full digital controls.



App MyHOME\_Up





Display thermostat



Touch Screen HOMETOUCH (compatible with Netatmo cameras)



MyHOME Server1

- NUVO audio system
- Third-party products and devices
- Indoor and outdoor Netatmo cameras

**EVERYTHING UNDER CONTROL**

Thanks to MyHOME\_Up, end users can manage their homes in full freedom: using Living Now manual controls, Touch Screen devices and Smartphones with the MyHOME\_Up App.

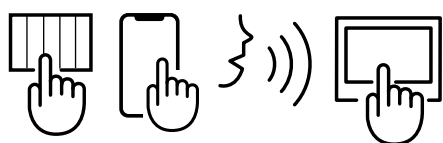

MyHOME\_Up system can be managed by voice through the Voice Control Alexa built-in and also with the Amazon and Google vocal assistants

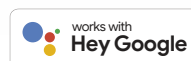

# THE VOICE OF HOME AUTOMATION

**VOICE CONTROL:  
INNOVATIVE DEVICE WITH INTEGRATED  
AMAZON ALEXA VOICE ASSISTANT**

Control MyHOME\_Up system like never before  
with integrated voice control.





*“Alexa, welcome me home”*

*“Alexa, what will the weather be like tomorrow?”*



**YOU ASK,  
ALEXA ANSWERS.**

Use your voice to activate home automation functions in your home: lights, shutters, scenarios, favourite music, or ask for any other information.

Note: with the “Welcome me home” scenario, it is possible to activate lights and shutters and disable the burglar alarm.



*“Alexa, set the alarm for 7:30”*

*“Alexa, switch off the lights”*

*“Alexa, activate the relaxation scenario”*

Note: with the “Relax” scenario, it is possible to activate lights and shutters, set a comfort temperature and listen to the preferred music through the NUVO multi-room system.

# A NEW WAY TO TOUCH HOME AUTOMATION

## **LIGHT CONTROLS AND FULL CONTROLS: A MULTISENSORIAL EXPERIENCE**

- New touch controls without cover plate
- Customised icons and LEDs using the app MyHOME\_Up
- Light and Full controls expandable to new functions





App MyHOME\_Up

### CREATE CUSTOMISABLE FUNCTIONS

The function associated to the control device and the corresponding icon can be changed at any moment, using the app MyHOME\_Up.

#### FUNCTION MODIFICATION



From dimmer control



To shutter control

#### FUNCTION EXTENSION



From the control of one light



To the control of two lights



**LIGHT CONTROL**  
To manage the lighting  
(1 or 2 lights, group and general)

### CHOOSE BETWEEN FULL AND LIGHT CONTROLS

Digital controls for every need.  
Two versions, endless customisation to be adapted to any lifestyle.



**FULL CONTROL**  
From 1 to 3 lights, dimmer, roller shutters, nuvo audio, load controls and scenarios.

### EXTEND THE CONTROL

Expand the system by adding new control devices with a new frame. Without wiring.

FROM 3 CONTROL DEVICES

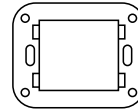

K4703AU support frame

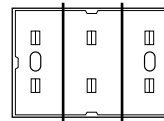

3 module-frame



Digital controls

TO 4 CONTROL DEVICES

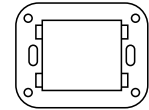

K4703AU support frame

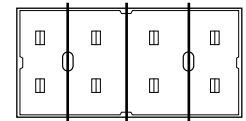

4 module-frame



Digital controls

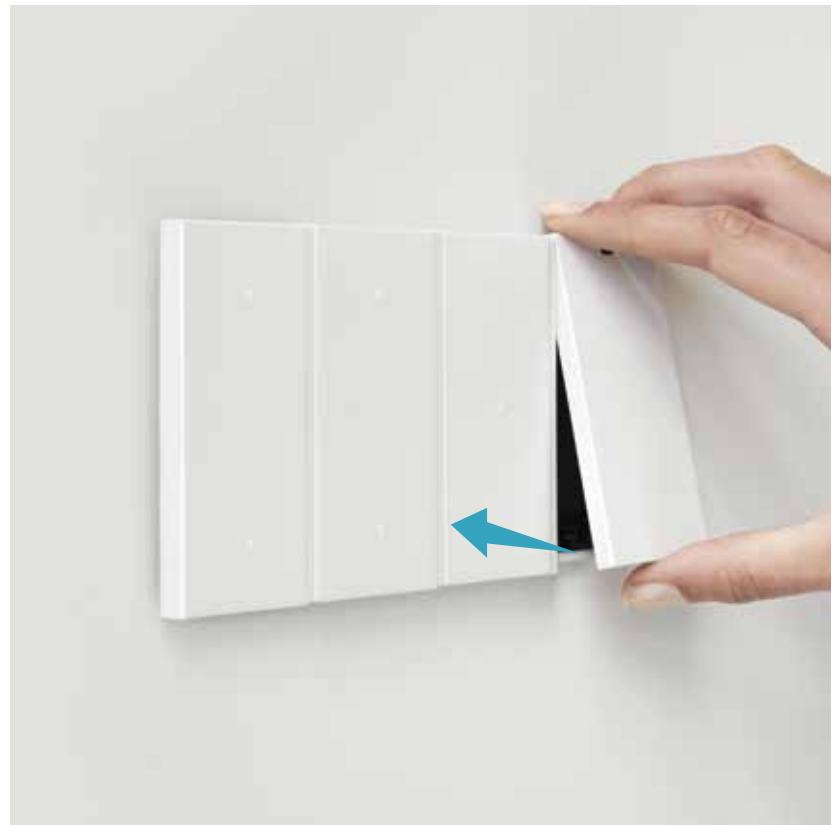

**MOVE THE POSITION**

With a simple operation, its possible to change the position of a control device while maintaining its function without wiring.



FROM THE LIVING ROOM



TO THE BEDROOM

# INSTALLATION OF DIGITAL CONTROLS

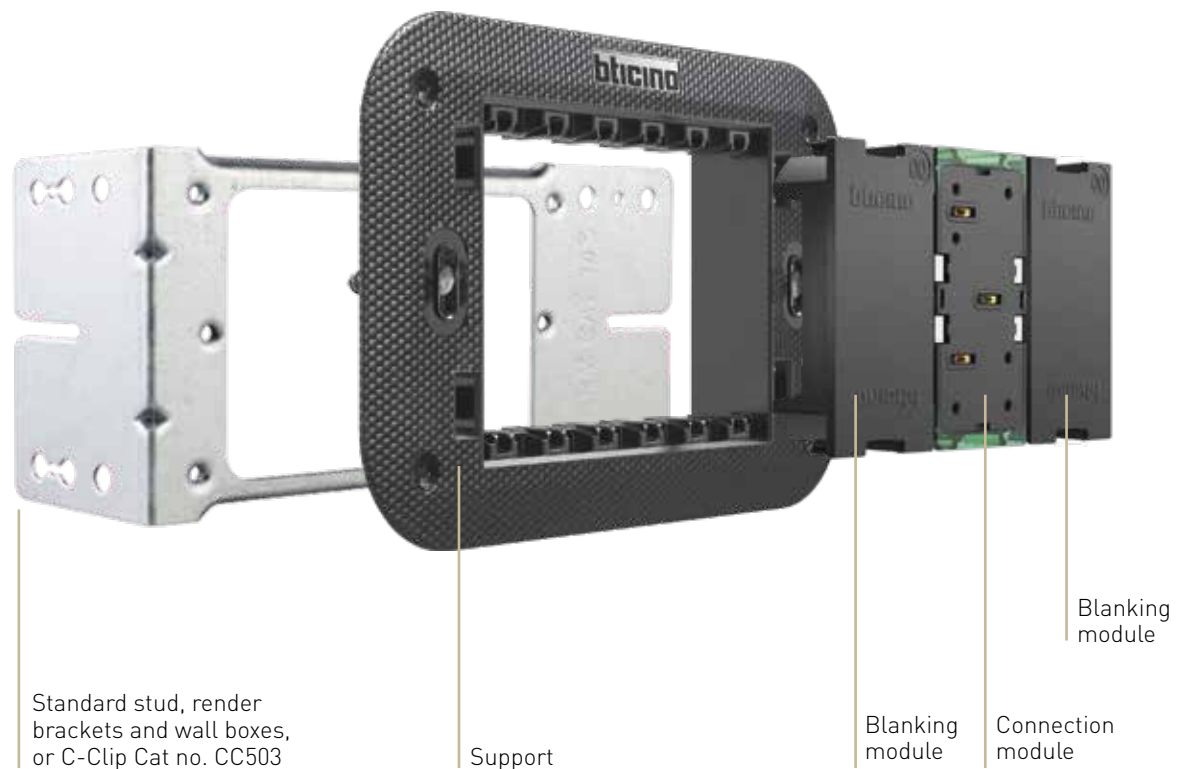

## FUNCTIONAL ELEMENTS

### INSTALLATION

With reference to the illustration, digital devices are installed using traditional mounting accessory and support, using an appropriate “frame” with 27 Vd.c. control device power supply contacts.

The Module for connection to the BUS system is installed on the support.



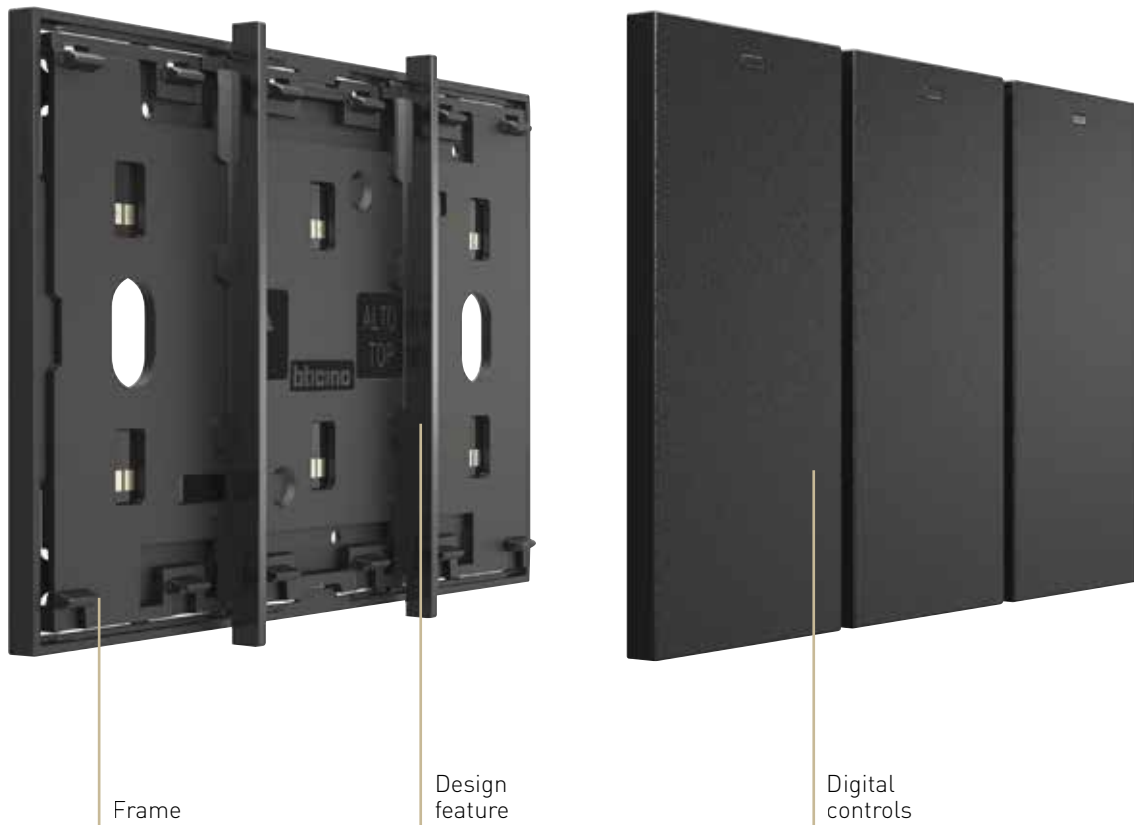

Frame

Design feature

Digital controls

## AESTHETIC ELEMENTS

### INSTALLATION OF VOICE CONTROL

This operation is completed in a similar way as the installation of digital controls, but it requires the removal of the two vertical finishing elements from the frame.

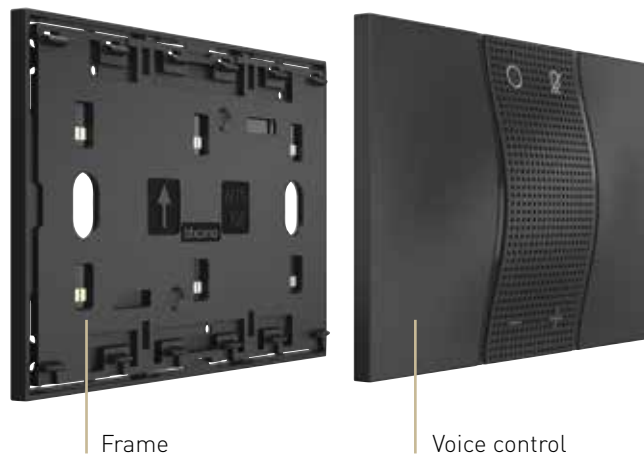

Frame

Voice control

# ALWAYS PERFECT INSTALLATION

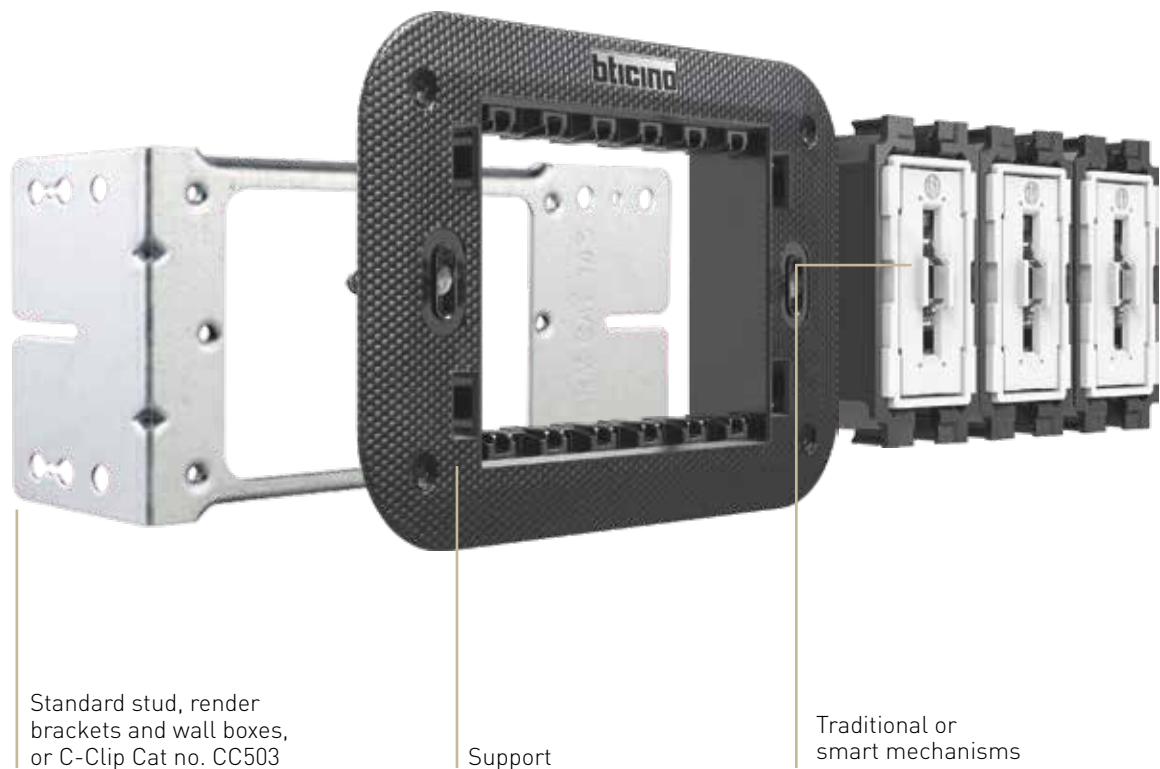

Standard stud, render brackets and wall boxes, or C-Clip Cat no. CC503

Support

Traditional or smart mechanisms

## FUNCTIONAL ELEMENTS

### STANDARD INSTALLATION

In both cases of **traditional** and **connected devices**, installation is always standard, with the following characteristics:

- traditional wiring;
- 3 module support frame (Cat no K4703AU), Single and Double powerpoints: can be installed using all standard stud brackets, render brackets or wall boxes. If a C-clip is required, only use Cat no. CC503.
- no configuration required.
- 4 and 6 Module support frames: use dedicated wall mounting boxes, refer to p.58

### YOUR WORK DOES NOT CHANGE, BUT IS MADE EASIER

The installation process doesn't change and once the aesthetic components are installed, you hand your customer a complete, good looking solution.

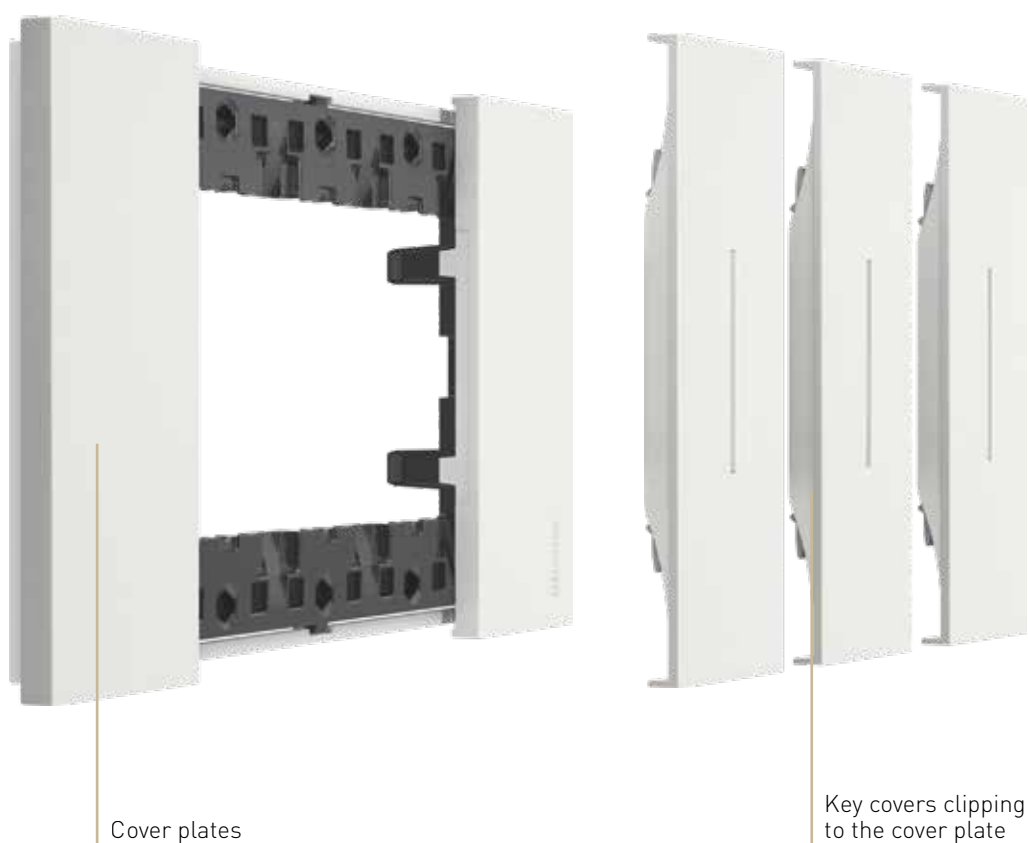

## AESTHETIC ELEMENTS

### SITE ACTIVITY SEQUENCE

- Install the system, fully working, but without aesthetic elements (cover plates and key covers)
- Protect the light point using the protective shell (supplied with the support)
- After completing all the works (including the painting of the walls), install the cover plates and the key covers

### MORE ADVANTAGES

- When repainting the walls in the future, the customer will be able to easily remove the light point aesthetic components, cover plates and key covers, and just as easily replace them on completion of the works
- After a few years the customer decides to change light points?  
It is possible to simply change the key covers, without touching the mechanisms

# SOLUTIONS FOR AN ALWAYS PERFECT INSTALLATION

## FULL TOUCH CONTROL: ERGONOMICS

The entire surface is functional. It can be activated from the top, bottom or centre, ensuring exceptional ergonomics.

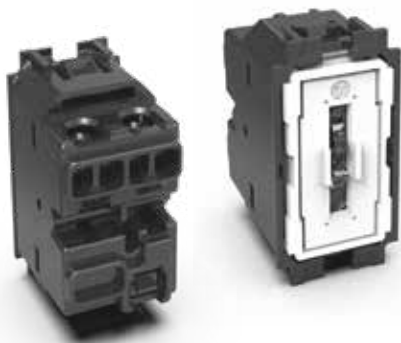

## FULL TOUCH CONTROL: ELECTRO MECHANICS

1) tested with over 80,000 activations with the load connected; double than the standard requirements.

This equals over 40 years of "normal" use.

2) 10AX 250 V, tested up to 700 A peak; also perfect for the new LED light bulbs, which generate significant peak current when switched on.

## SELF CENTERING SYSTEM

This patented cover self-centering system ensures that the control covers are always aligned with the other components of the light point, even after extended use.



**FLOATING FRAME**

It's the flexible floating frame at the back of the cover plate that ensures that the light point perfectly adheres to any wall.

The floating frame gives the possibility of:

- 1) hiding wall defects;
- 2) hiding any irregularity in flush mounted boxes positioning;
- 3) hiding the external collars of plasterboard boxes.

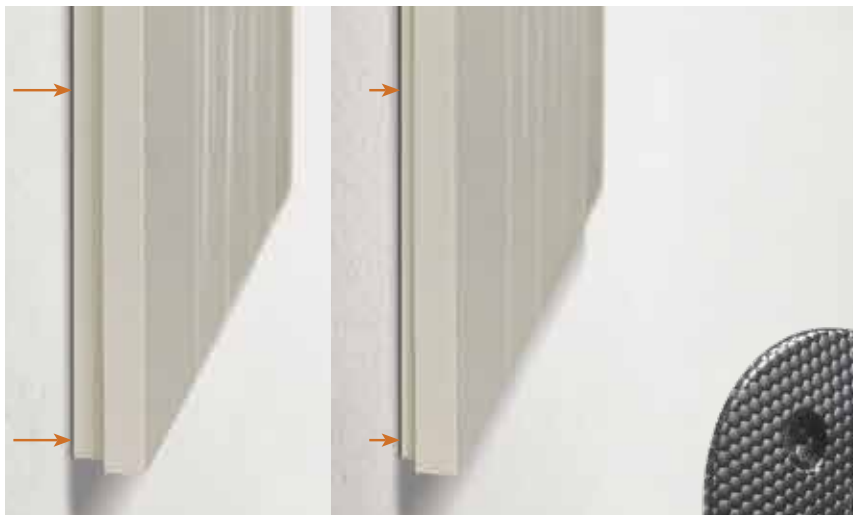

**STRONGER SUPPORT**

Reinforced frame, thanks to the new geometry and high performance materials.



**BETTER PROTECTION**

The support has a protective shell, which can be used to protect supports and mechanisms from possible damage during decorating activities, for example when painting the walls.

# Living Now





LVNSW1WE



LVNSW2BL



LVNSW3WE



LVN787ABL



LVN777AWE

Cat. no.	Switches 10 AX - 250 V a.c. - Two-way
<input type="checkbox"/> LVNSW1WE <input checked="" type="checkbox"/> LVNSW1BL	<b>Supplied with clip-in illumination LED accessory</b> <b>1 gang</b> White Black
<input type="checkbox"/> LVNSW2WE <input checked="" type="checkbox"/> LVNSW2BL	<b>2 gang</b> White Black
<input type="checkbox"/> LVNSW3WE <input checked="" type="checkbox"/> LVNSW3BL	<b>3 gang</b> White Black

Cat. no.	Powerpoints 10 A - 250 V a.c.
<input type="checkbox"/> LVN787AWE <input checked="" type="checkbox"/> LVN787ABL	<b>Single powerpoint</b> White Black
<input type="checkbox"/> LVN777AWE <input checked="" type="checkbox"/> LVN777ABL	<b>Double powerpoint</b> White Black
<b>Data outlet Cat6</b>	
<input type="checkbox"/> LVNDA1WE <input checked="" type="checkbox"/> LVNDA1BL	<b>1 gang</b> White Black
<input type="checkbox"/> LVNDA2WE <input checked="" type="checkbox"/> LVNDA2BL	<b>2 gang</b> White Black

White colour cover

Black colour cover

Neutral item (without cover)



K4003



K4004



K4003 + KW01



KG01







K4003 + KW01M2





KG01M2

Devices to be completed with appropriate cover as indicated below

Cat. no.	Switch, two-way switch, pushbutton, intermediate switch 10 AX - 250 V~
<input type="radio"/> K4003	 1P 10 AX, 250 V~ 2-way switch, screw and plates terminals, lightable - 1 module
<input type="radio"/> K4004	 1P 10 AX, 250 V~ 4-way switch, screw and plates terminals - 1 module
<input type="radio"/> K4004L	 1P 10 AX, 250 V~ LIT Intermediate switch, screw and plates terminals, with white LED for backlighting (the LED is not interchangeable) - 1 module
<input type="radio"/> K4004LB	 1P 10 AX, 250 V~ LIT 4-ways switch, screw and plates terminals, with blue LED for backlighting (the LED is not interchangeable) - 1 module

Cat. no.	Pushbutton 10 A - 250 V~
<input type="radio"/> K4005	 1P (NO) 10 A, 250 V~ pushbutton, screw and plates terminal, lightable - 1 module

Cat. no.	Covers
<input type="checkbox"/> KW01 <input checked="" type="checkbox"/> KG01	<b>1 module</b>  Lightable cover for item K4003, K4004, K4004L, K4004LB, K4005
<input type="checkbox"/> KW01M2 <input checked="" type="checkbox"/> KG01M2	<b>2 modules</b>  Lightable cover for item K4003, K4004, K4004L, K4004LB, K4005

**Notes**

- for the LEDs to use see the "Backlighting LEDs" section later on in the catalogue.
- for solutions requiring 2-module covers for the main controls, it will be necessary to install two "half-module blanking modules" (item K4949) at the sides of the control, see example on page 57.

White colour cover

Black colour cover

Neutral item (without cover)



# Living Now dimmer



K4411



K4410



KW19



KG19

Devices to be completed with appropriate cover as indicated below





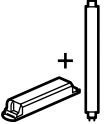
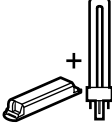
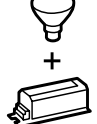



Cat. no.	Dimmer
OK4411	<b>Universal dimmer</b>  Universal pushbutton dimmer - resistive/ inductive/ capacitive/fluorescent/compact/ dimmer LED. 100 to 240 V~ 50 ÷ 60 Hz - connection without neutral - 2 modules
OK4410	<b>Dimmer for ballast lamp</b>  Pushbutton dimmer for ballast lamp with 0-10V output. 100 to 240 V~ 50 to 60 Hz - 2 modules

Cat. no.	Cover
<input type="checkbox"/> KW19 <input checked="" type="checkbox"/> KG19	<b>1 module</b>  Cover for item K4411, K4410

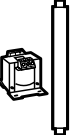
## DIMMER K4410 - LOAD COMPATIBILITY

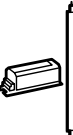
		1 -10 V		
				
 +35°C 0°C  2 x 2,5mm <sup>2</sup> 100-240 V~ 50/60 Hz	240 V	Max 600 VA Min. 20 VA	Max 600 VA Min. 20 VA	Max 600 VA Min. 20 VA
	100 V	Max 300 VA Min. 20 VA	Max 300 VA Min. 20 VA	Max 300 VA Min. 20 VA

## DIMMER K4411 - LOAD COMPATIBILITY

		R		L		C/L		Dimmable	Dimmable LED
									
 +35°C 0°C  2 x 2.5 mm <sup>2</sup> 100- 240 V~ 50/60 Hz	240 V	Max. 400 W Min. 3 W	Max. 400 W Min. 3 W	Max. 400 VA Min. 3 VA	Max. 200 VA Min. 3 VA	Max. 400 VA Min. 3 VA	Max. 200 VA Min. 3 VA	75 W or max. 10 lamps 3 W	75 W or max. 10 lamps 3 W
	100 V	Max. 200 W Min. 3 W	Max. 200 W Min. 3 W	Max. 200 VA Min. 3 VA	Max. 100 VA Min. 3 VA	Max. 200 VA Min. 3 VA	Max. 100 VA Min. 3 VA	37 W or max. 10 lamps 3 W	37 W or max. 10 lamps 3 W

White colour cover

Black colour cover



Neutral item (without cover)



**Living Now**  
two-pole switches

**Living Now**  
shutter/blind switches and thermostats



Devices to be completed with appropriate cover as indicated below

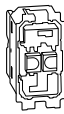

Cat. no.	<b>Switches</b>
<input type="checkbox"/> KW4002 <input checked="" type="checkbox"/> KG4002	 2P 16 AX, 250 V~, lightable switch - 1 module
<input type="checkbox"/> KW02 <input checked="" type="checkbox"/> KG02	<p><b>Cover</b> <b>1 module</b></p>  Cover for item KW4002 Cover for item KG4002



Cat. no.	<b>Electronic thermostats</b>
<input type="checkbox"/> KW4441 <input checked="" type="checkbox"/> KG4441	 Electronic room thermostat - relay output with 1 contact in switching free of 5(2)A potential. - power supply 230 V~ - 2 modules
<input type="radio"/> K4027	<p><b>Shutter/blind switches</b></p>  1P 10 AX, 250 V~ changeover switch, double-key 1-0-2, not lightable - 1 module
<input type="checkbox"/> KW06 <input checked="" type="checkbox"/> KG06	<p><b>Cover</b></p>  Cover for item K4027 Cover for item K4027

**Living Now**  
australian standard sockets



Devices to be completed with appropriate cover as indicated below

Cat. no.	Australian standard sockets
<input type="checkbox"/> LVNM787A	<b>Single socket</b>  2 P+E 10 A , 250 V a.c. - autoswitched - 2 module
<input type="checkbox"/> LVNM777A	<b>Double socket</b>  2 P+E 10 A 250 V a.c. - autoswitched - supplied with grid

Cat. no.	Covers
<input type="checkbox"/> KW67 <input checked="" type="checkbox"/> KG67	<b>Single socket</b>  White Black
<input type="checkbox"/> KW69 <input checked="" type="checkbox"/> KG69	<b>Double socket</b>  White Black



K4285C1



K4285C2



K4286C1



K4286C2



K4287C2



KW4286CW2



KW10C



KG12C

Devices to be completed with appropriate cover as indicated below

Cat. no.	USB charger
<input type="radio"/> K4285C1	5 V d.c. type A USB charger only for charging electronic devices up to 1,500 mA - 110-230 V 50-60 Hz DIRECT power supply - 1 module
<input type="radio"/> K4285C2	5 V d.c. type A USB charger for quick charge of one single electronic device up to 3,000 mA or simultaneous charging of two devices up to 1,500 mA - 110-230 V 50-60 Hz DIRECT power supply - 2 modules
<input type="radio"/> K4286C1	5 V d.c. type C USB charger only for charging electronic devices up to 1,500 mA - 110-230 V 50-60 Hz DIRECT power supply - 1 module
<input type="radio"/> K4286C2	5 V d.c. type C USB charger for quick charge of one single electronic device up to 3,000 mA or simultaneous charging of two devices up to 1,500 mA - 110-230 V 50-60 Hz DIRECT power supply - 2 modules
<input type="radio"/> K4287C2	5 V d.c. type A and C USB charger for quick charge of single electronic devices up to 3,000 mA or simultaneous charging of two devices up to 1,500 mA - 110-230 V 50-60 Hz DIRECT power supply - 2 modules

Cat. no.	Induction charger
<input type="checkbox"/> KW4286CW2 <input checked="" type="checkbox"/> KG4286CW2	It allows the quick and wireless charging of smartphones with induction receiver up to 1,000 mA (compliant with WPC Qi standard). The antislip support surface is inclined by 10°. Antitheft lock function. Energy performance >85%. Equipped with a 3.000 mA type-A USB port for the powering of a second device - 12 W. Possibility of simultaneous recharging of two devices, up to 500 mA wirelessly, and up to 1,200 mA through the USB port. Dimension 136.5 x 70 x 56.5 mm. The cover of the selected colour is supplied in the same box as the charger.

Cat. no.	Cover for USB charger
<input type="checkbox"/> KW10C <input checked="" type="checkbox"/> KG10C	<b>1 module</b> Cover for item K4285C1 and K4286C1
<input type="checkbox"/> KW12C <input checked="" type="checkbox"/> KG12C	<b>2 modules</b> Cover for item K4285C2, K4286C2, K4287C2

White colour cover



Black colour cover

Neutral item (without cover)

**Living Now**  
RJ connectors for data



Devices to be completed with appropriate cover as indicated below



Cat. no.	RJ45 connectors	
<input type="checkbox"/> KW4279C6 <input checked="" type="checkbox"/> KG4279C6	 Category 6 UTP	Type of connection TOOLLESS IDC
<input type="checkbox"/> KW4279C6A <input checked="" type="checkbox"/> KG4279C6A	 Category 6A UTP	Type of connection TOOLLESS IDC



Cover for RJ45, RJ11 connectors and Keystone adapters	
<input type="checkbox"/> KW07 <input checked="" type="checkbox"/> KG07	 1 module Cover for all the RJ45 and RJ11 connectors

**Living Now**  
TV sockets and A/V connectors



Devices to be completed with appropriate cover as indicated below

Item	TV socket 1 module
○ K4202D	 Direct coaxial socket for single-user aerial systems, including central remote powered systems and single-user central satellite systems with current and signal transfer for the selection of the channels - shielded connection clamps with captive screws - Diam. 9.5 mm - male connector - 1 module
○ K4202F	 Type F TV coaxial connector - impedance 75 Ω - screw hook - 1 module
○ K4214D	 Direct demixed coaxial socket for single-user aerial systems, also remote powered and shunting centralised and for single-user / shunting centralised satellite systems with current and signal transfer for the selection of the channels; Ø 9.5 mm male TV connector - type F SAT connector - 1 module









Cover for TV socket 1 module	
<input type="checkbox"/> KW08 <input checked="" type="checkbox"/> KG08	 1 module Cover for item K4202D and K4202F
<input type="checkbox"/> KW09 <input checked="" type="checkbox"/> KG09	 1 module Cover for item K4214D

Audio Connector A/V connector	
○ K4284P	 Pre-connected HDMI 1.4 connector - 1 module

Cover for audio and A/V connectors	
<input type="checkbox"/> KW14 <input checked="" type="checkbox"/> KG14	 1 module Cover for item K4284P



Devices to be completed with appropriate cover as indicated below

Item	Key card switches	Item	Cover for functions for hotel
○ K4549	 <p>Key card switch for the power supply inside the hotel room - slot light with built-in lamp - 30 second switch-off delay - power supply 230 V~. The completion of the light point requires two "half-module blanking modules" (item K4949) at the sides of the badge holder. To be installed with supports and cover plates with minimum size of 3 modules</p>	<input type="checkbox"/> KW22M2 <input checked="" type="checkbox"/> KG22M2	<b>2 modules</b>  Cover for item K4549 et K4548
○ K4548	 <p>Key card switch for the power supply inside the hotel room - slot light with built-in lamp - 30 second switch-off delay - power supply 230 V~ - with RFID technology recognition. The completion of the light point requires two "half-module blanking modules" (item K4949) at the sides of the badge holder. To be installed with supports and cover plates with minimum size of 3 modules</p>	<input type="checkbox"/> KW22 <input checked="" type="checkbox"/> KG22	<b>3 modules</b>  Cover for item K4549 et K4548
○ K4027H	 <p>1P 10 AX, 250 V~ changeover switch, double-key 1-0-2 for Hotel, LIT - 1 module (The LED is replaceable with item K4743V230RG)</p>	<input type="checkbox"/> KW06H <input checked="" type="checkbox"/> KG06H	<b>1 module</b>  Cover for item K4027H
○ K4373	 <p>Lampholder with two built-in LEDs, green and red. Can be used as out of room visual signal with double notification: do not disturb and make up the room - The LEDs cannot be replaced - 127/ 230 V~ power supply - 1 module</p>	<input type="checkbox"/> KW11H <input checked="" type="checkbox"/> KG11H	 Cover for item K4373

# Living Now

## LED and blanking modules

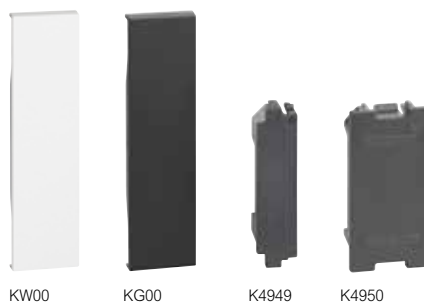

Devices to be completed with appropriate cover as indicated below

Cat. no.	LED for control and socket lighting
LN4743/230T	LED for backlighting of the following "basic control devices": K4003 and K4005 white LED - 230 V~ - night signal
LN4743/12T	white LED - 12/24 V~ - night signal
H4743/230B	blue LED - 230 V~ - night signal
H4743/12B	blue LED - 12/24 V~ - night signal

Cat. no.	Blanking modules
K4950	Blanking module - 1 module
K4949	<b>Installation accessory</b> 1/2 module blanking module - does not require a cover

Cat. no.	Covers for Blanking modules
<input type="checkbox"/> KW00 <input checked="" type="checkbox"/> KG00	<b>1 module</b> Cover for item K4950
<input type="checkbox"/> KW00M2 <input checked="" type="checkbox"/> KG00M2	<b>2 modules</b> Cover for item K4950

### EXAMPLES OF LED CONNECTION ON A SWITCH

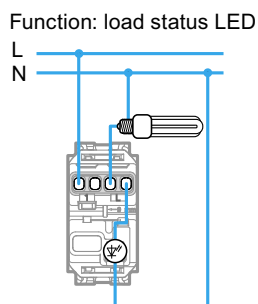
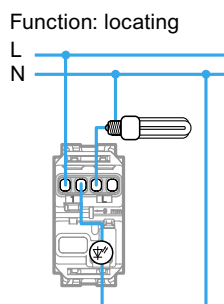

### Control backlighting led connection

Note for the connection of 230 V.a.c. LEDs for the backlighting of control devices: when LEDs are fitted to help locate the control itself, it must be taken into account that energy saving and fluorescent lamps do not allow in series connection of the LED on the load. It is therefore necessary to also take a neutral conductor near the control, so that the LED may be connected directly between phase and neutral, and will always be on.





White colour cover

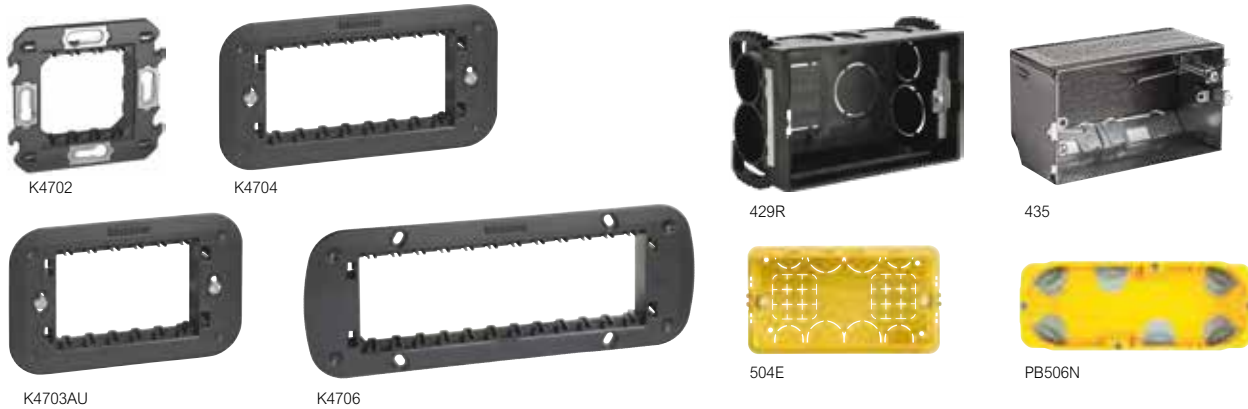

Black colour cover



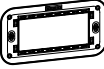

Neutral item (without cover)

**Living Now**  
support frames and mounting boxes

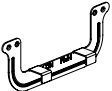
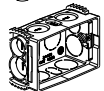

Cat. no.	Supports
K4702	 2-module support frame supplied with protective shell
K4703AU	 3-module support frame
K4704	 4-module support frame supplied with protective shell
K4706	 6-module support frame supplied with protective shell

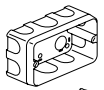
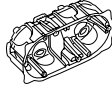
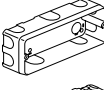
Cat. no.	Mounting boxes
80151	 Flush-mount box
80051	 Plasterboard box

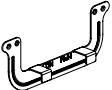
Cat. no.	Mounting accessories
	<b>For 3 module frame K4703AU</b> The 3 module frame K4703AU is compatible with most stud brackets, render brackets or wall boxes. If a C-clip is to be used, only Cat no CC503 is compatible
CC503	 C-clip
429R	 Plastic wall box
435	 Fire and acoustic rated box
	<b>For 4 module frame K4704</b>
504E	 Flush-mount box
PB504N	 Plasterboard box
	<b>For 6 module frame K4706</b>
506L	 Flush-mount box
PB506N	 Plasterboard box
	<b>For single powerpoints (LVN787A) and double powerpoints (LVN777A)</b>
CC503	 C-clip

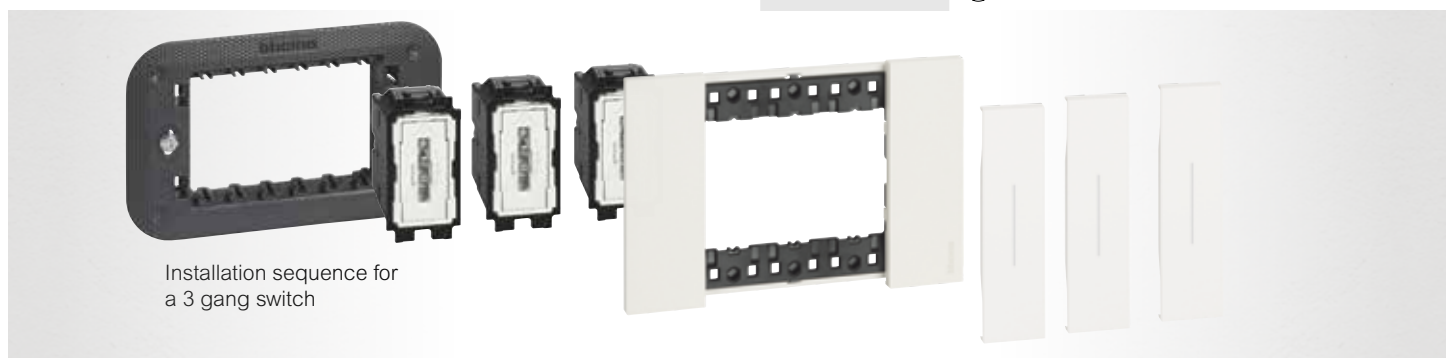

Installation sequence for a 3 gang switch

□ White colour cover

■ Black colour cover

○ Neutral item (without cover)



# Living Now <sup>WITH</sup> Netatmo





## SMART ELECTRICAL SYSTEM

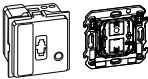

# Living Now with Netatmo smart electrical system - MODULAR VERSION

## gateway and wireless master switch



Cat. no.	Gateway
<input type="radio"/> K4500C	 <p>Gateway. This pack enables to create a connected installation in the home. It can be used to control lighting, roller shutters and electrical equipment plugged into connected sockets:</p> <ul style="list-style-type: none"> <li>- using your smartphone and the Home + Control app</li> <li>- using voice assistants</li> <li>- from the general control at the entrance to your home</li> </ul> <p>Supplied with the Home/Away wireless master switch required for the association procedure of all connected devices. Power supply 110-230 V~ - 2 modules</p>
<input type="radio"/> K4510C	 <p>Gateway as above. Supplied with the flush-mounted Home/Away wireless master switch 1 module required for the association procedure of all connected devices. Power supply 110-230 VA - 2 modules</p>
<input type="radio"/> 412181	 <p>Gateway as above for DIN switchboard. Supplied without wireless In&amp;Out master scenario control item K4570CW. - 2.5 DIN modules.</p>

Cover required for the gateway	
<b>2 modules</b>	
<input type="checkbox"/> KW30M2 <input checked="" type="checkbox"/> KG30M2	 <p>Cover for item K4500C in combination with the relative colored cover item KW40M2, KG40M2, and for item K4510C in combination with the relative colored cover item KW40, KG40.</p>

Covers for the gateway scenario control	
<b>1 module</b>	
<input type="checkbox"/> KW40 <input checked="" type="checkbox"/> KG40	 <p>Cover for item K4570CWI (scenario control in the gateway item K4510C)</p>
<b>2 modules</b>	
<input type="checkbox"/> KW40M2 <input checked="" type="checkbox"/> KG40M2	 <p>Cover for item K4570CW (scenario control in the gateway item K4500C)</p>

# Living Now with Netatmo smart electrical system

**main controls**  
eliot



K4003C

574243





K4003C + KW01



KG01

K4003C + KW01M2

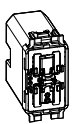
KG01M2

Devices to be completed with appropriate cover as indicated below

Cat. no.	Connected switches and light relay
○ K4003C	 <p>Connected 2-ways switch. It allows to control lights locally or remotely. The connected 2ways switch has the same installation and usability of a traditional 2ways switch and it is compatible with all loads with max pover 250 W. It s equipped with a blue LED light used always on for localization modality or on, when the light is on for the load status modality. It can be associated with "wireless light switches". Caution: Must be connected to the neutral. Power supply 110-230 V~ - 1 module</p>
574243	 <p>Connected lighting micromodule. It allows to control lights locally or remotely. It is compatible with all loads with max pover 300 W. It can be connected to one or more traditional push-button or associated with "wireless light switches". It is installed as a traditional rele in the box (behind the button) or in derivation boxes. Caution: Must be connected to the neutral. Power supply 110-230 V~</p>

Cat. no.	Covers
<input type="checkbox"/> KW01 <input checked="" type="checkbox"/> KG01	<b>1 module</b>  Lighttable covers for items K4003C
<input type="checkbox"/> KW01M2 <input checked="" type="checkbox"/> KG01M2	<b>2 modules</b>  Lighttable covers for items K4003C

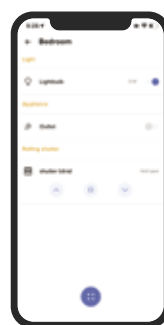

## HOME + CONTROL

Note: for the use of the connected devices, the gateway, item **K4500C** or **412181** must be installed as part of the system.

If the gateway is connected to the internet through the Wi-Fi network, it will be possible to manage the system from the home using the specific **HOME + CONTROL** App

Three-way switching with connected two-way switch, item K4003C, installed instead of a traditional two-way switch

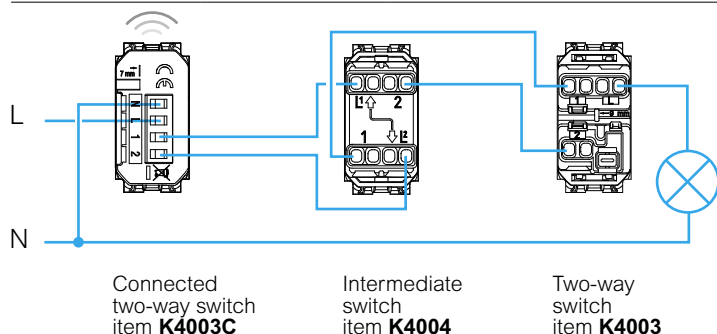

Connected two-way switch item **K4003C**

Intermediate switch item **K4004**

Two-way switch item **K4003**

Three-point lighting control with pushbuttons and connected lighting micromodule, item 574243, installed instead of a traditional relay

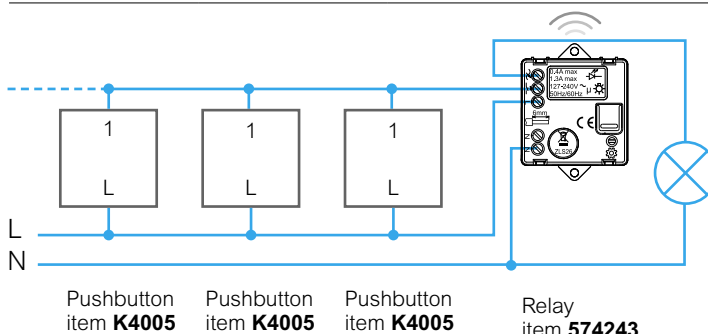

Pushbutton item **K4005**

Pushbutton item **K4005**

Pushbutton item **K4005**

Relay item **574243**



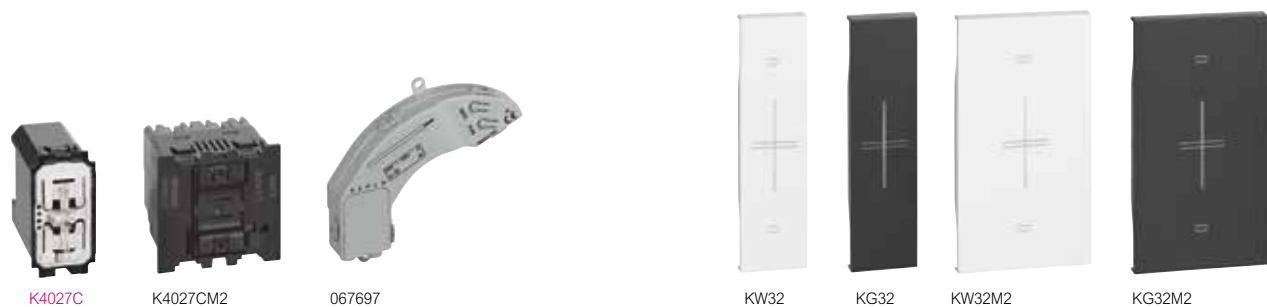

□ White colour cover

■ Black colour cover

○ Neutral item (without cover)

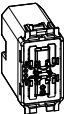

Devices to be completed with appropriate cover as indicated below

Cat. no.	Connected devices for shutters	Cat. no.	Covers
○ K4027C	 <p>Connected rolling shutter switch - It allows the control of a shutter locally or remotely. Compatible with all standard rolling shutter motors ( with a mechanical or electromechanical stop and max power 500 VA ) controlled by a wired shutter switch (switching of the same motor power supply). Not compatible with motors for radio-controlled or pulse-controlled roller shutters. It can be associated with one or more wireless commands. Caution: Must be connected to the neutral. Power supply 110-230 V~ - 1 module</p>	<input type="checkbox"/> KW32 <input checked="" type="checkbox"/> KG32	<p><b>1 module</b></p>  Cover for item K4027C
○ K4027CM2	 <p>As K4027C - 2 modules</p>	<input type="checkbox"/> KW32M2 <input checked="" type="checkbox"/> KG32M2	<p><b>2 modules</b></p>  Cover for items K4027C and K4027CM2
○ 067697	 <p>Connected micromodule for shutters. Associated to one or more shutter wireless controls, it controls a shutter locally or remotely. Compatible with all standard shutter motors (with mechanical or electronic limit switch and maximum power 500 VA), controlled by a wired shutter changeover switch (changeover with the same power supply as the motor). Not compatible with radio controlled or pulse controlled shutter motors. It can be installed in the existing shutter box with no need of masonry works. Power supply 110-230 V~</p>		

Note: for the use of the connected devices, the gateway, item **K4500C** or **412181** must be installed as part of the system.

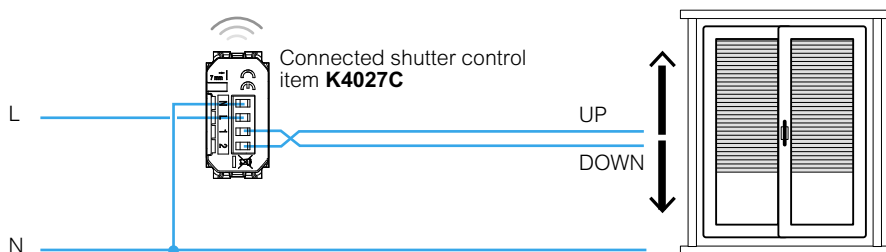

For correct operation, connect also the neutral conductor to the connected devices.

If the gateway is connected to the internet through the Wi-Fi network, it will be possible to manage the system from the home using the specific **HOME + CONTROL** App

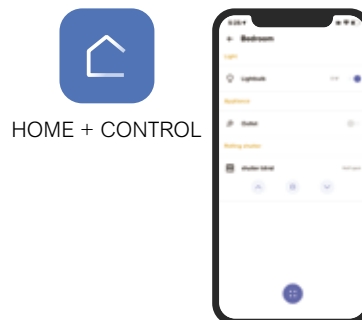

White colour cover

Black colour cover

○ Neutral item (without cover)

# Living Now with Netatmo smart electrical system

**dimmer**  
**eliot**



K4411C



KW33

KG33

Devices to be completed with appropriate cover as indicated below

Cat. no.	Connected Dimmer/Switch
○ K4411C	<p><b>Universal dimmer</b></p>  <p>Dimmer/switch. It allows to control lights locally or remotely, with the dimmer functionality that can be activated from APP Home+Control. It has the same installation and usability of a traditional switch and it is compatible with all loads (LED, halogen) with max power 150 W at 230 V (or 75 W at 110 V). It s equipped with a blue LED light used for localization modality or load status modality, configurable by APP. It can be connected to one or more traditional push-button or associated with "wireless light switches". Caution: Must be connected to the neutral. Power supply 110-230 V~ - 1 module</p>

Cat. no.	Covers
<input type="checkbox"/> KW33 <input checked="" type="checkbox"/> KG33	<p><b>1 module</b></p>  <p>Cover for item K4411C</p>

Note: for the use of the connected devices, the gateway, item **K4500C** or **K4510C** must be installed as part of the system.

If the gateway is connected to the internet through the Wi-Fi network, it will be possible to manage the system from the home using the specific **HOME + CONTROL** App

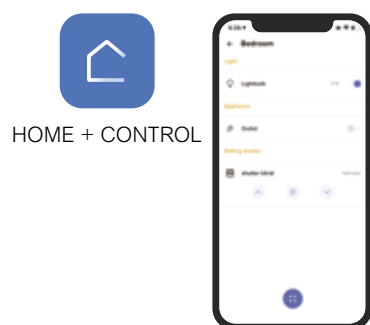

HOME + CONTROL

□ White colour cover

■ Black colour cover



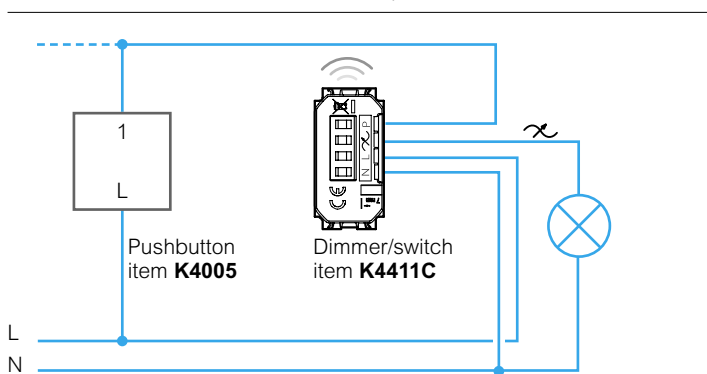

○ Neutral item (without cover)

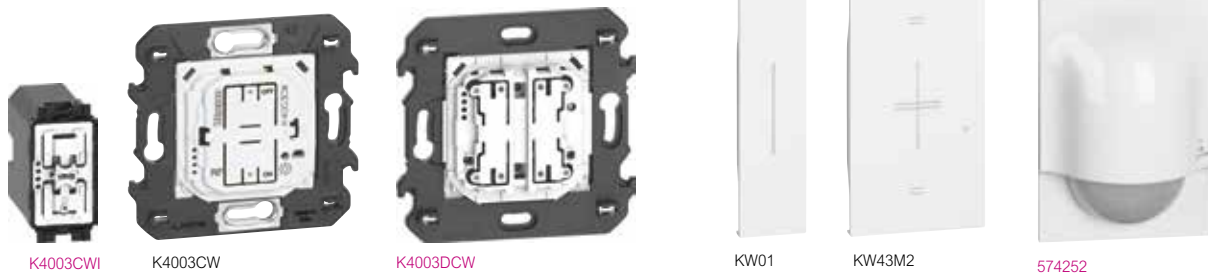

Dimmer/switch item K4411C with remote pushbuttons

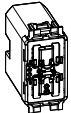



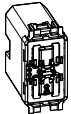

Devices to be completed with appropriate cover as indicated below

Cat. no.	Wireless controls for light
○ K4003CWI	 <p>Wireless light switch. It allows the ON / OFF and dimming control of one or more connected devices for the lighting control. It can be installed in any flush-mounted box without any wiring. The battery can be replaced without removing it from the supporting frame. Integrated LED for low battery indication. Powered by battery 3V type CR2032 (supplied) with an autonomy of 8 years - 1 module</p>
○ K4003CW	 <p>Wireless light switch. It allows the ON / OFF and dimming control of one or more connected devices for the lighting control. Surface installation with repositionable stickers (supplied) or onto a flush mounting box. Integrated LED for low battery indication. Powered by battery 3V type CR2032 (supplied) with an autonomy of 8 years - 2 modules</p>
○ K4003DCW	 <p>Wireless light switch. It is equipped with two buttons to control two different connected devices for lights. Each single button can be associated with one or more devices. Surface installation with repositionable stickers (supplied) or onto a flush mounting box. Integrated LED for low battery indication. Powered by battery 3V type CR2032 (supplied) with an autonomy of 8 years - 2 modules</p>
○ 067694	 <p>Wireless module for mechanical switch. It allows to change a two-way switch or a traditional pushbutton into a wireless light control for ON/OFF control of one or more devices connected for light control. The small size allows the installation in the flush mounted box. CR2032 type 3V power battery with 8 year expected life supplied (as standard).</p>

Cat. no.	Wireless controls for shutter
○ K4027CWI	 <p>Rolling shutter wireless switch - It allows the control of one or more connected rolling shutter switches. It can be installed in any flush-mounted box without any wiring. The battery can be replaced without removing it from the supporting frame. Integrated LED for low battery indication. Powered by battery 3V type CR2032 (supplied) with an autonomy of 8 years - 1 module</p>
○ K4027CW	 <p>Rolling shutter wireless switch - It allows the control of one or more connected rolling shutter switches. Surface installation with repositionable stickers (supplied) or onto a flush mounting box. Integrated LED for low battery indication. Powered by battery 3V type CR2032 (supplied) with an autonomy of 8 years - 2 modules</p>

Cat. no.	Cover
<input type="checkbox"/> KW01 <input checked="" type="checkbox"/> KG01	<b>1 module</b>  Cover for item K4003CWI  Cover for item K4003CW  Cover for item K4027CWI
<input type="checkbox"/> KW33 <input checked="" type="checkbox"/> KG33	
<input type="checkbox"/> KW32 <input checked="" type="checkbox"/> KG32	
<input type="checkbox"/> KW42M2 <input checked="" type="checkbox"/> KG42M2	<b>2 modules</b>  Cover for item K4003CW  Cover for item K4003DCW  Cover for item K4027CW
<input type="checkbox"/> KW36M2 <input checked="" type="checkbox"/> KG36M2	
<input type="checkbox"/> KW43M2 <input checked="" type="checkbox"/> KG43M2	

Cat. no.	Motion sensor wireless
○ 574252	 <p>It controls one or more devices connected for light control. Infrared detection with angle of 140°. Distance of the adjustable sensor from 2 to 8 m. Switch off delay with 1 to 30 min adjustable delay time and 1 to 1000 lux brightness threshold. Test possible with a 5 sec. delay. Recommended assembly height: 2.5 m. Optimum distance between 2 detectors: 6 m. For indoor and outdoor use (IP44). Supplied with 2 1.5V AA batteries for power supply.</p>



HOME + CONTROL

Note: for the use of the connected devices, the gateway, item **K4500C** or **412181** must be installed as part of the system.

If the gateway is connected to the internet through the Wi-Fi network, it will be possible to manage the system from the home using the specific **HOME + CONTROL** App

# Living Now with Netatmo smart electrical system

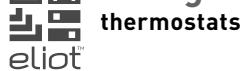

XW8003



XG8003



XW8003W

The Smarter with Netatmo connected thermostat, together with the dedicated HOME+CONTROL APP, is a device which allows you to adjust and monitor the temperature in the rooms precisely and accurately; all the programming and most of the functions are performed simply and intuitively using the APP. Thanks to its Wi-Fi connection, Smarter with Netatmo can be programmed and controlled remotely; it can also display the temperature and humidity measured in the room. The temperature level can be set locally for manual operation and the Boost mode can be activated. The Boost forces the switching on of the system for a limited time (30, 60 or 90 minutes) independent of the measured and programmed temperature.

It's also possible to set a different temperature in each room of the house for the maximum comfort, thanks to its compatibility with Netatmo smart radiator valves.

Smarter with Netatmo can also be controlled with Google, Amazon Alexa and Apple Home Kit voice assistants.

Features:

- 110 ÷ 230 V~, 50/60 Hz power supply;
- 2 W max absorption;
- maximum cable section 1 x 1.5mm<sup>2</sup>;
- temperature measurement 5 ÷ 40°C;
- temperature set-point 5 ÷ 40°C,
- increase of 0.5°C;
- 1-contact output in switching free of potential 5(2)A.

Available in two colours: white (XW8003) and black (XG8003).

Cat. no.	<b>Connected thermostats</b>	<b>COMING SOON</b>
<input type="checkbox"/> XW8003 <input checked="" type="checkbox"/> XG8003	White Black	
<input type="checkbox"/> XW8003W	Features: as XW8003. Installation on the wall, using screws and dowels suitable for the installation surface (brickwork, plasterboard, tiles etc.). Only available in white.	



**App HOME + CONTROL for management of connected devices**





White colour cover

Black colour cover

Neutral item (without cover)



Devices to be completed with appropriate cover as indicated below

Cat. no.	Connected devices for energy management	Cat. no.	Cover
○ K4531C	 <p>Connected socket module - wiring to a power outlet, allows to remotely control appliances and check the consumption ( instantaneous, daily, monthly ).                      It is also possible to receive notifications in case of anomalous consumption.                      The connected socket module is compatible with any device electric and large appliances up to 16 A 3680 W max. (protected against overloads).                      It is equipped with a LED light lit in blue when it is on. This option can be enabled or disabled in the "Home+Control" app.                      It can be associated with "wireless light switches".                      Power supply 110-230 V~                      - 1 module</p>	<input type="checkbox"/> KW31 <input checked="" type="checkbox"/> KG31	<b>1 module</b>  Cover for item K4531C
○ 412015	 <p>Connected DIN meter. It allows to measure the energy consumption of the house electric installation (instantaneous, daily, monthly).                      It is also possible to receive notifications in case of exceeded the maximum power provided by your contract to avoid possible black-out.                      A toroid is provided to read the current.                      Power supply 110-230 V~                      - 1 DIN module</p>		













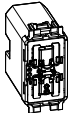

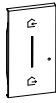

# Living Now with Netatmo smart electrical system - MODULAR VERSION

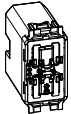
wireless controls for scenarios management

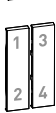

Devices to be completed with appropriate cover as indicated below

Cat. no.	Wireless Home/Away scenario controls	Cat. no.	Covers
○ K4570CWI	 <p>Home / Away wireless switch. It is equipped with 2 buttons for activating Home / Away scenarios. Scenarios can be customized by the Home + Control app. It can be installed in any flush-mounted box without any wiring. The battery can be replaced without removing it from the supporting frame. Integrated LED for low battery indication. Powered by battery 3V type CR2032 (supplied) with an autonomy of 8 years - 1 module</p>	<input type="checkbox"/> KW40 <input checked="" type="checkbox"/> KG40	<b>1 module</b>  Cover for item K4570CWI  Cover for item K4574CWI
○ K4570CW	 <p>Home / Away wireless switch. It is equipped with 2 buttons for activating Home / Away scenarios. Scenarios can be customized by the Home + Control app. Surface installation with repositionable stickers (supplied) or onto a flush mounting box. Integrated LED for low battery indication. Powered by battery 3V type CR2032 (supplied) with an autonomy of 8 years - 2 modules</p>	<input type="checkbox"/> KW40M2 <input checked="" type="checkbox"/> KG40M2	<b>2 modules</b>  Cover for item K4570CW  Cover for item K4574CW
○ K4574CWI	 <p>It is equipped with 2 buttons for activating Wake Up / Sleep scenarios. Scenarios can be customized by the Home + Control app. It can be installed in any flush-mounted box without any wiring. The battery can be replaced without removing it from the supporting frame. Integrated LED for low battery indication. Powered by battery 3V type CR2032 (supplied) with an autonomy of 8 years - 1 module</p>	<input type="checkbox"/> KW41 <input checked="" type="checkbox"/> KG41	<b>1 module</b>  Cover for item K4574CWI
○ K4574CW	 <p>It is equipped with 2 buttons for activating Wake Up / Sleep scenarios. Scenarios can be customized by the Home + Control app. Surface installation with repositionable stickers (supplied) or onto a flush mounting box. Integrated LED for low battery indication. Powered by battery 3V type CR2032 (supplied) with an autonomy of 8 years - 2 modules</p>	<input type="checkbox"/> KW41M2 <input checked="" type="checkbox"/> KG41M2	<b>2 modules</b>  Cover for item K4574CW  Cover for item K4575CW
○ K4575CW	 <p>It's equipped with 4 buttons for activating of scenarios 1,2,3 and 4. Scenarios can be customized by the Home+ Control app. Surface installation with repositionable stickers (supplied) or onto a flushmounting box. Integrated LED for low battery indication. Powered by battery 3V type CR2032 (supplied) with an autonomy of 8 years - 2 modules.</p>	<input type="checkbox"/> KW37M2 <input checked="" type="checkbox"/> KG37M2	<b>2 modules</b>  Cover for item K4575CW

White colour cover

Black colour cover

○ Neutral item (without cover)

# Living Now

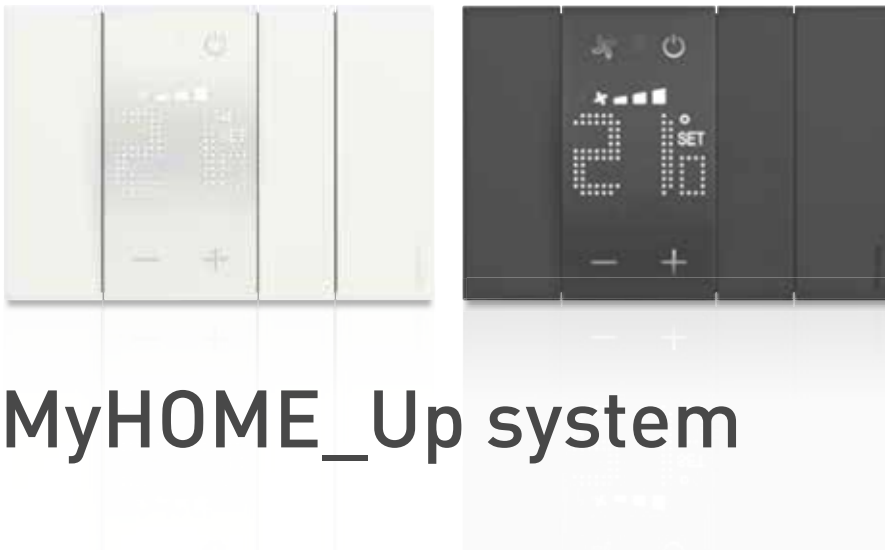

**MyHOME\_Up system**



MYHOMESERVER1

067259

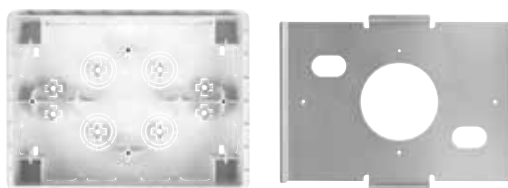

003487

3487AP

Cat. no. **Control server using the app**

○ MYHOMESERVER1  Server to associate devices during the system starting-up and for the local and remote management of the functions by the user with the specific MyHOME\_Up application for Android and iOS smartphones or tablets.

**Note:** For the details of the products managed by MyHome\_Up and the compatible products, see the corresponding guide.

○ 067259 **HOMETOUGH - Touch screen 7"**

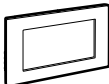

HOMETOUGH - Touch Screen 7" for the management of all MyHOME\_Up functions, that can be integrated with the video door entry system and with indoor and outdoor Netatmo cameras, to be used as connected internal unit. To use the home automation functions, configuration is not necessary. It is possible to display the MyHOME\_Up system status and control the integrated functions (lights, automation, scenarios, burglar alarm, temperature management, Nuvo music system, ...). Thanks to the "DOOR ENTRY for HOMETOUGH" application, available both for Android and iOS operating systems, it is also possible to manage the video door entry functions of a BTicino 2 wires system using the 7" capacitive display or the Smartphone. Flush mounted installation with box for masonry walls (item 003487) or wall mounted installation with the supplied metal bracket. Available in tech grey and in white.

○ 003487 **Box for flush mounted installation**

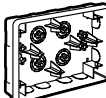

Box for flush mounted installation of the HOMETOUGH Touch screen item 067259. Width 197 mm, height 148 mm and depth 52 mm.

○ 3487AP

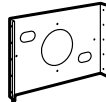

Support for flush mounted installation on plasterboard walls of the HOMETOUGH Touch screen.

Cat. no. **SCS/DALI interface**

○ F429  DALI dimmer, 8 independent outputs with maximum load 16 ballast at 230 Vac, pushbutton for load direct control - 6 DIN modules

○ F459  **Driver manager**  
Integration platform with other brand systems - 6 DIN modules

Contact your Legrand Australian representative to check the feasibility of specific integrations and to request the licence needed to use the Driver manager.

**App DOOR ENTRY for HOMETOUGH**

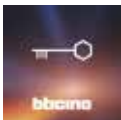

This allows the user to manage the video internal unit calls locally and remotely using the smartphone or with a simple touch open the gate, activate the cameras and the video door entry answering machine.

**App MyHOME\_Up**



Mobile device App that allows:  
- the installer, thanks to a self-learning procedure, to easily associate the devices together when starting up the system;  
- the user to manage his home home-automation wherever he is.





KG8013



KW8011



K8001



KW8100



KW8103

- Cat. no.
- KW8013
  - KG8013

**Voice control**



Amazon Alexa digital control device with voice assistant, including two touch controls for lighting management.  
27 Vd.c. power supply from BUS through connection module item KW8001 or additional power supply unit - 3 modules

- KW8010
- KG8010

**Light control**



Touch control for the management of ON/OFF light functions. One single control can manage from 1 to 2 functions between single lights, light groups or general lights.  
- 1 module

- KW8011
- KG8011

**Full control**



Touch control for the management from 1 to 3 functions between: lights on/off, load control, dimmer, shutters up/down with or without preset and scenarios. It can also be used as group or general control. It has on-board proximity sensor that allows the display of function icons/symbols when approaching the control - 1 module

- K8001

**Connection modules**



Device for the power supply of controls and actuators through BUS frame item KW/ KG8103, KW/KG8103P1, KW/KG8104, KW/KG8104P1

- Cat. no.
- KW8100
  - KG8100

**Blanking module**



Cover for blanking module art. K4950 - 1 module

- KW8103
- KG8103
- KW8103P1
- KG8103P1
- KW8104
- KG8104
- KW8104P1
- KG8104P1

**Frames for 3 and 4 module grids**



BUS frame with intermediate control separators (removable). For the installation of up to 3 digital controls or covers, (item KW/KG8100) in 3-module box with support K4703AU



BUS frame with intermediate control separators (removable). For the installation of up to 4 digital controls or covers, (item KW/KG8100) in 3-module box with support K4703AU



BUS frame with intermediate control separators (removable). For the installation of up to 4 digital controls or covers, (item KW/KG8100) in 4-module box with support K4704





BUS frame with intermediate control separators (removable). For the installation of up to 5 digital controls or covers, (item KW/KG8100) in 4-module box with support K4704

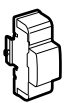
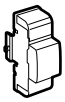

F411U2 F411/4

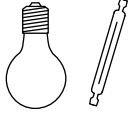
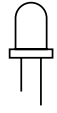
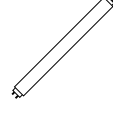
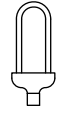
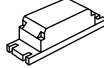
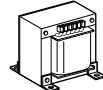
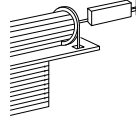
Cat. no.	Actuators for centralisations
OF411U2	 <p>Actuator with 2 independent relays – for single and double loads: 10 A resistive and 6 A incandescence lamps, 500 W for reducer motors, 2 A <math>\cos\phi</math> 0.5 for ferromagnetic transformers and 250 W for fluorescent lamps                      - logic relay interlock via configuration - it has "Zero crossing" technology                      - 2 DIN modules</p>
OF411/4	 <p>Actuator with 4 independent relays - for single, double or mixed loads: 2 A resistive, 2 A incandescence lamps, 500 W for reducer motors, 2 A <math>\cos\phi</math> 0.5 for ferromagnetic transformers and 70 W for fluorescent lamps - logic relay interlock via configuration                      - 2 DIN modules</p>

LOAD COMPATIBILITY (250 V~ 50/60 Hz)							
Actuators	Type						
							
	Energy saving incandescence and halogen lamps	LED lamps	Linear fluorescent lamps <sup>1)</sup>	Compact fluorescent lamps	Electronic transformers <sup>3)</sup>	Ferromagnetic transformers <sup>2) 3)</sup>	Reducer motors for shutters <sup>4)</sup>
<b>F411U2</b>	10 A 1380 W	250 W Max 4 lamps	4 A 230 W	250 W Max 4 lamps	4 A 230 W	4 A $\cos\phi$ 0,5 460 VA	2 A 460 W
<b>F411/4</b>	2 A 460 W	70 W Max 2 lamps	0.3 A 70 W	70 W Max 2 lamps	0.3 A 70 W	2 A $\cos\phi$ 0,5 460 VA	2 A 460 W

- Notes:**
- 1) Power factor corrected fluorescent lamps, discharge lamps.
  - 2) Account must be taken of the transformer yield to calculate the effective power of the load connected to the actuator. For example if a dimmer is connected to a 100 VA ferromagnetic transformer with yield 0.8, the effective power of the load will be 125 VA.
  - 3) The transformer must be loaded at its rated power and however never less than 90% of this power. It is preferable to use a single transformer rather than several transformers in parallel. For example it is better to use a single 250 VA transformer with 5 50W spotlights connected rather than use 5 50 VA transformers in parallel each with a 50 W spotlight.
  - 4) The  symbol on the actuators refers to the shutter reducer motors.

□ White colour cover

■ Black colour cover

○ Neutral item (without cover)





F413N







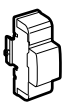

F429

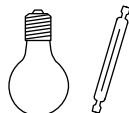

F418U2

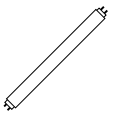
Cat. no.	Dimmers for centralisations
○ F413N	 <p>1-output dimmer to supply fluorescent lamps or LED sources with input 1-10 V for single loads up to 2.5 A at 230 Va.c. – type of screw connection - power supply 27 Vd.c. – absorption 30 mA – max 10 ballast that can be connected (clamps 1-2) - with pushbutton for load direct control - version for fastening on DIN rail - 2 modules</p>
○ F429	 <p>DALI dimmer with 8 independent outputs for the connection of up to 16 DALI reactors for each output – 230 V a.c. power supply 50/60 Hz; 110 - 240 Vd.c. – absorption 5 mA - with pushbutton for load direct control - version for fastening on DIN rail - 6 modules</p>

Cat. no.	Multi-load dimmers for centralisations
○ F418U2	 <p>Two-channel dimmer for the management of dimmer LEDs, dimmer compact fluorescent lamps (CFL), energy saving halogen lamps and electronic transformers at 110-230V. Possibility of parallelisation of the two channels to increase the maximum power which can be managed. power supply 27 Vd.c., absorption 18 mA - version for fastening on DIN rail - 4 modules</p>

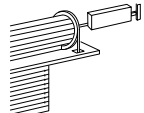
LOAD COMPATIBILITY (230 V~ 50/60 HZ)							
Actuators	Type						
							
	Energy saving incandescence and halogen lamps	LED lamps	Linear fluorescent lamps <sup>1)</sup>	Compact fluorescent lamps	Electronic transformers <sup>3)</sup>	Ferromagnetic transformers <sup>2) 3)</sup>	Reducer motors for shutters <sup>4)</sup>
<b>F413N</b>	- -	- -	2 A 460 W <sup>5)</sup> Max 10 ballast, type T5, T8, compact or driver for LED	- -	- -	- -	- -
<b>F418U2</b>	2x300 W	2x300 VA	-	2x300 VA	2x300 VA	2x300 VA	-
<b>F429</b>	SCS/DALI dimmer interface - 8 x16 ballast						

- Notes:**
- 1) Power factor corrected fluorescent lamps, discharge lamps. 2) Account must be taken of the transformer yield to calculate the effective power of the load connected to the actuator. For example if a dimmer is connected to a 100 VA ferromagnetic transformer with yield 0.8, the effective power of the load will be 125 VA.
  - 3) The transformer must be loaded at its rated power and however never less than 90% of this power. It is preferable to use a single transformer rather than several transformers in parallel. For example it is better to use a single 250 VA transformer with 5 50W spotlights connected rather than use 5 50 VA transformers in parallel each with a 50 W spotlight.
  - 4) The  symbol on the actuators refers to the shutter reducer motors.
  - 5) Only compatible with lamps with 1/10 V ballast.

□ White colour cover

■ Black colour cover

○ Neutral item (without cover)



KW4691



KG4691



F430/2







F430R8



F430V10

Devices to be completed with appropriate cover as indicated below

Cat. no.	Thermostat
<input type="checkbox"/> KW4691 <input checked="" type="checkbox"/> KG4691	Probe with backlit display that controls the temperature of an individual zone. It features an input for the connection of a contact line (e.g. window contact). It can be used for the management of different types of systems, and the adjustment of the fan speed when fan coils are used. Possibility of automatic operation (summer/winter), with compatible systems - 2 modules White Black

Cat. no.	Actuators
<input type="radio"/> F430/2	 Actuator with 2 independent relays – for single and double loads: 6 A resistive, 2A motor driven valves and pumps - configuration based logic relay interlock - 2 DIN modules
<input type="radio"/> F430/4	 Actuator with 4 independent relays - for single, double or mixed loads: 4 A resistive, 1 A motor driven valves, pumps and fan coils - configuration based logic relay interlock - 2 DIN modules
<input type="radio"/> F430R8	 Actuator with 8 independent relays for the control of on-off valves, motorised valves (open-close and three points), pumps and fan coils with 2 and 4 tubes - 4A resistive, 1A motor valves, pumps and fan-coils- SCS-bus connection - 4 DIN modules
<input type="radio"/> F430R3V10	 Actuator with 3 independent relays and 2 x 0-10 Volts outputs for the control of fan coils with 2 and 4 tubes with proportional 0-10 Volt valves - 4A resistive, 1A fan coil - SCS-BUS connection - 4 DIN modules
<input type="radio"/> F430V10	 Actuator with 2 x 0-10 Volt outputs for the control of 0-10 proportional valves - SCS-BUS connection - 2 DIN modules





**Consumption display**

Cat. no. ○ F520  
 Meter for the measurement of electricity on a maximum of 3 lines, by connecting 3 toroids to the appropriate inputs. Version for fastening on DIN rail - 1 module. The device is fitted with 1 toroid.

○ 3523  
 Additional electricity meter toroid, item F520 and for actuator with sensor, item F522 for the measurement of the earth leakage current. Cable length 400 mm.

**Load control management**

○ F521  
 Central unit for the management and control of the actuators of the load control system, to prevent the risk of detachment of the limiter of the electricity supplier. The central unit manages up to 63 loads, a contract power between 1.5 and 18 kW, and tolerance up to +/- 20%. It integrates an electricity meter for the controlled line. Version for fastening on DIN rail - 1 module. The device is fitted with 1 toroid.

○ F522  
 Actuator with integrated current sensor for the measurement of the controlled load consumptions. 1 relay - 10 A for incandescence lamps or ferromagnetic transformers, and 4 A for fluorescent lamps or ferromagnetic transformers, and 500 W for compact fluorescent and LED lamps - Bistable relay with zero crossing for the Automation and/or Load control management functions. Version for fastening on DIN rail - 1 module. Earth leakage control by connecting the additional toroid, item 3523.

○ F523  
 1 relay actuator - for incandescence lamps and 4 A for fluorescent lamps or ferromagnetic transformers, and 500 W for compact fluorescent and LED lamps - bistable relay with zero crossing for the Automation and/or Load control management functions. Version for fastening on DIN rail - 1 module.

**Accessories**

○ 3508BUS  
 removable clamp for BUS connection - width 3.81 mm

○ 3508U3  
 removable clamp 3 poles

**Power supplies**

Cat. no. ○ E49  
 Compact power supply - input 230 Va.c. - output 27 Vd.c. Maximum current delivered 600 mA - 2 DIN modules.

**Connection cables**

○ L4669  
 Sheathed pair made up of 2 flexible wires with unshielded plaited sheath - insulation 300/500 V - complies with standards CEI 46-5 and CEI 20-20 - coil length 100 metres

○ L4669/500  
 as above - in 500 m coils

System	Cable	
	L4669 - L4669/500	L4669KM1 - 336905
Automation	●	●(1)
Energy Management/Consumption Display	●	●(1)
Temperature control	●	●(1)
Video door entry system		●

NOTE (1): for systems underground cable sections



## Living Now



## INSTALLATION AND COVER PLATE RANGE

EXAMPLE OF INSTALLATION OF THE LIGHT POINT WITH 1-MODULE COVER



EXAMPLE OF LIGHT POINT COMPOSITION

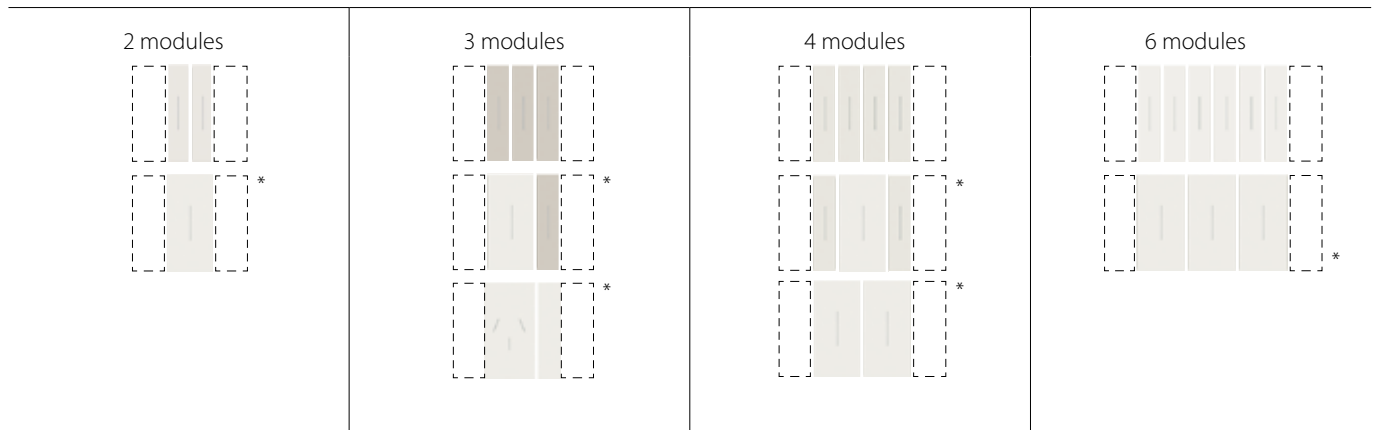

\* Note: for solutions using one 2-module cover for the main controls, it will be necessary to use two "half-module blanking modules" (item K4949) at the sides of the control. (see the sample diagrams below)

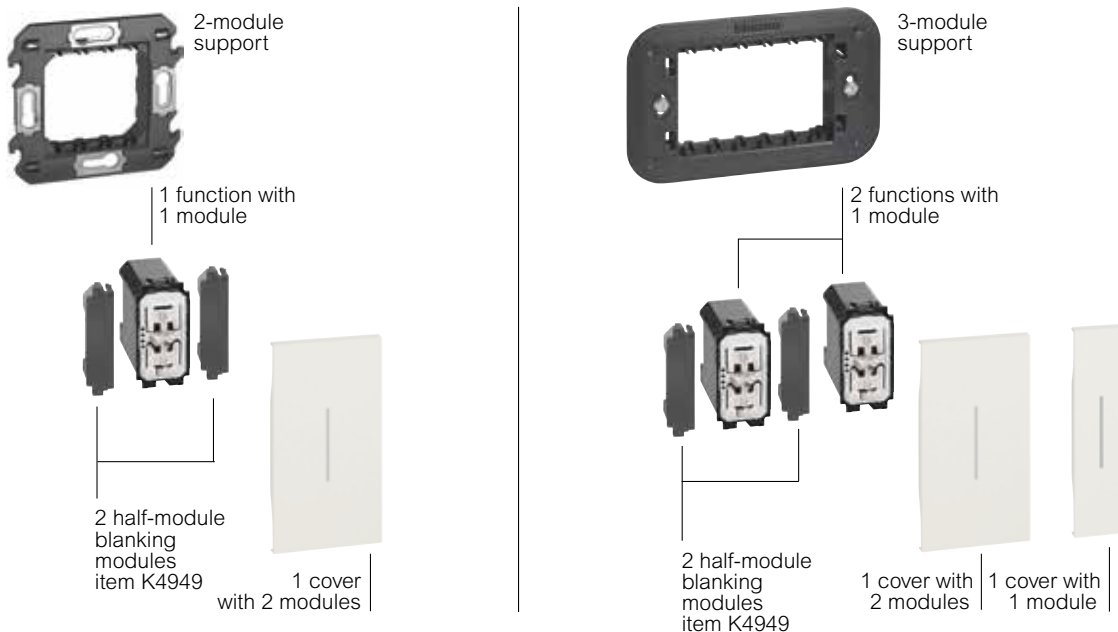

**INSTALLATION EXAMPLE OF THE DIGITAL CONTROLS**

Installation with actuator in DIN switchboard

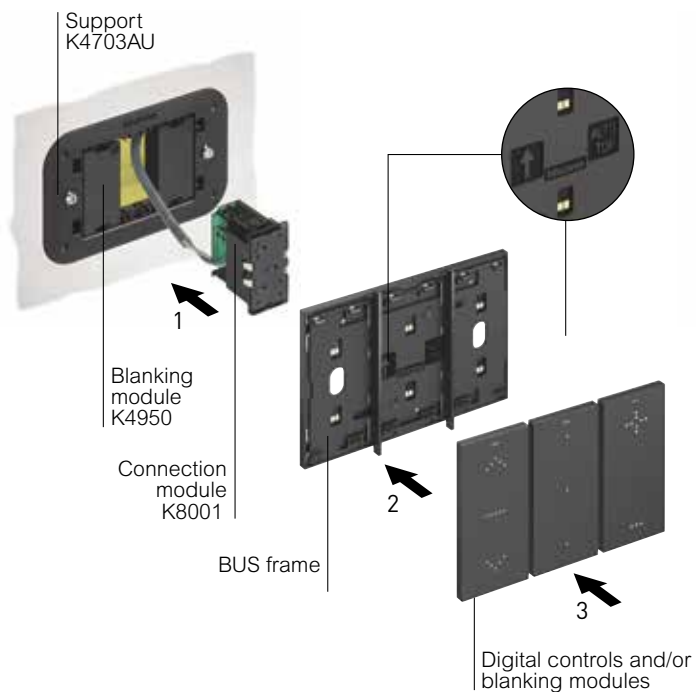

At the side of the connection module, install 2 blanking modules, item K4950, in any position.

Installation of the voice control

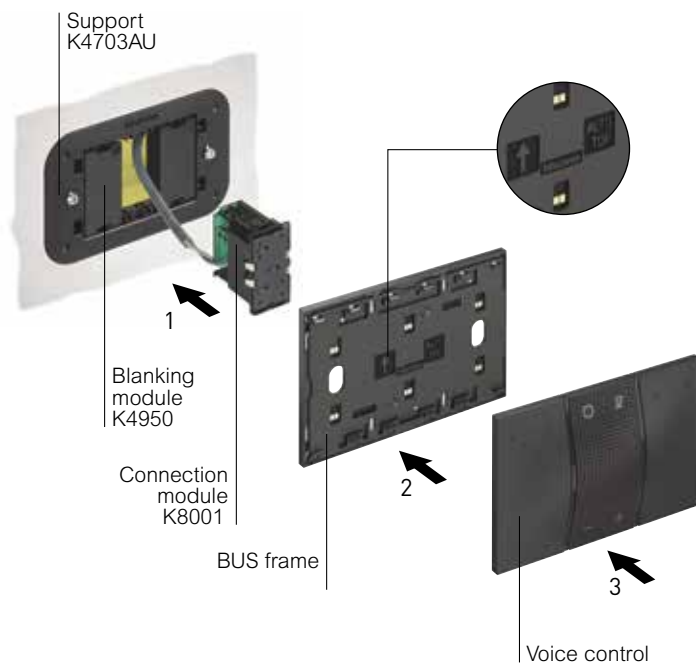

















Remove the finishing bars from the electrified frame.

**Living Now**

range of cover plates - 1 module installation



**SELECTION TABLE**

Finish	 DGPO	 2 modules	 3 modules/SGPO	 4 modules	 6 modules
 WHITE	KA4814KW	KA4802KW	KA4803KW	KA4804KW	KA4806KW
 GOLD	KA4814ZW	KA4802ZW	KA4803ZW	KA4804ZW	KA4806ZW
 MOON	KA4814NW	KA4802NW	KA4803NW	KA4804NW	KA4806NW
 ICE	KA4814DW	KA4802DW	KA4803DW	KA4804DW	KA4806DW
 SKY	KA4814DA	KA4802DA	KA4803DA	KA4804DA	KA4806DA
 PIXEL	KA4814MW	KA4802MW	KA4803MW	KA4804MW	KA4806MW
 OAK	KA4814LM	KA4802LM	KA4803LM	KA4804LM	KA4806LM
 BLACK	KA4814KG	KA4802KG	KA4803KG	KA4804KG	KA4806KG
 SPACE	KA4814NG	KA4802NG	KA4803NG	KA4804NG	KA4806NG
 STEEL	KA4814ZG	KA4802ZG	KA4803ZG	KA4804ZG	KA4806ZG
 WALNUT	KA4814LG	KA4802LG	KA4803LG	KA4804LG	KA4806LG
 NIGHT	KA4814DG	KA4802DG	KA4803DG	KA4804DG	KA4806DG

Supports	 Integrated in DGPO mechanism	 K4702	 K4703AU	 K4704	 K4706
----------	--	---	---	---	---

**Notes:**  
 - The cover plate/cover combinations shown in these pages are purely indicative. Each cover plate can in fact be combined with covers of any colours, as required by the customer (white and black).  
 - The zamak and wood finishes are obtained using non-mass production procedures. The differences among the various cover plates are therefore a distinguishing valuable element.

## Living Now



**TECHNICAL INFORMATION,  
DIMENSIONAL DATA**

**LIGHT POINT INSTALLATION**

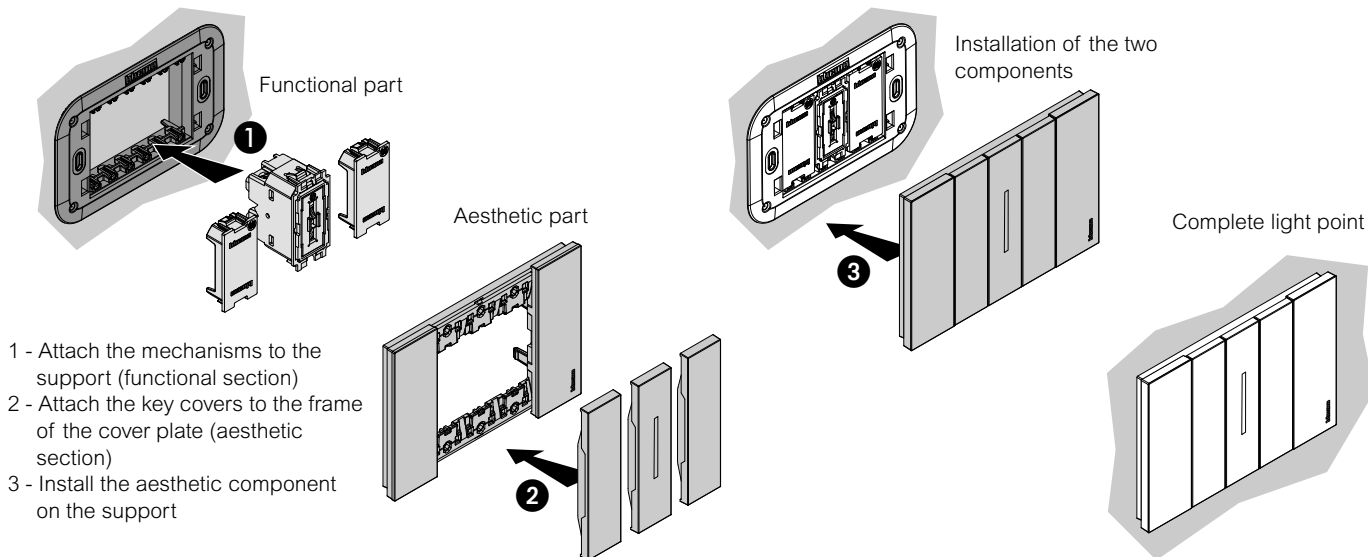

**REMOVING KEY COVERS**

Key covers are those that move in relation to the light point, to allow the activation of a control (traditional, connected or MyHOME\_Up)

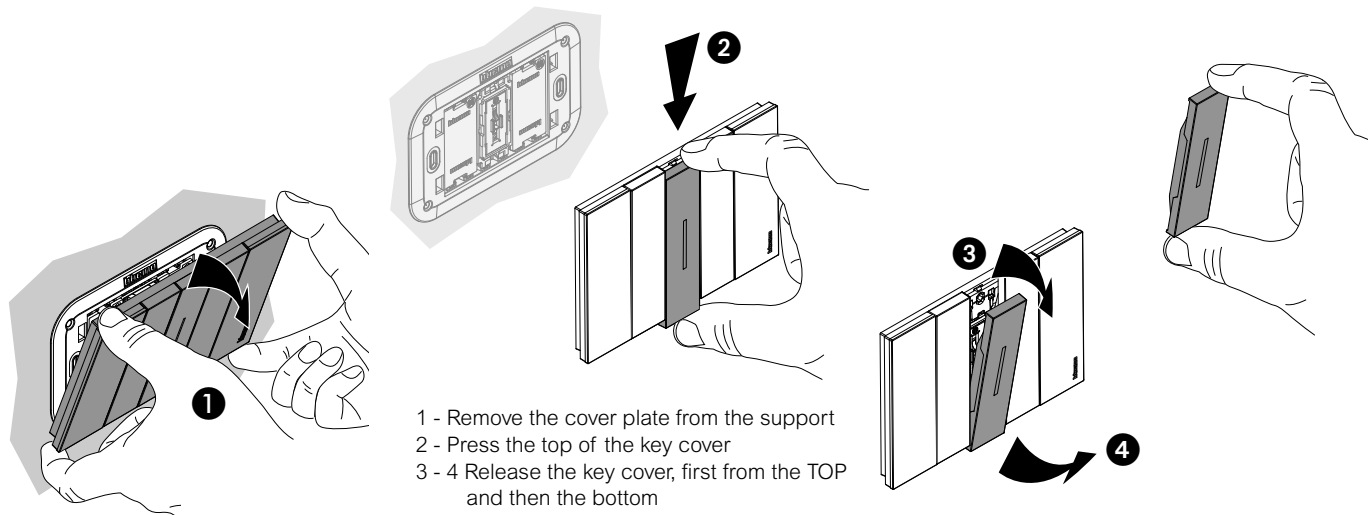

**REMOVING FIXED COVERS**

Fixed covers those are attached to the cover plates, such as for example blanking modules and all non-control devices (e.g. sockets, RJ connectors, TV sockets, USB chargers, etc.)

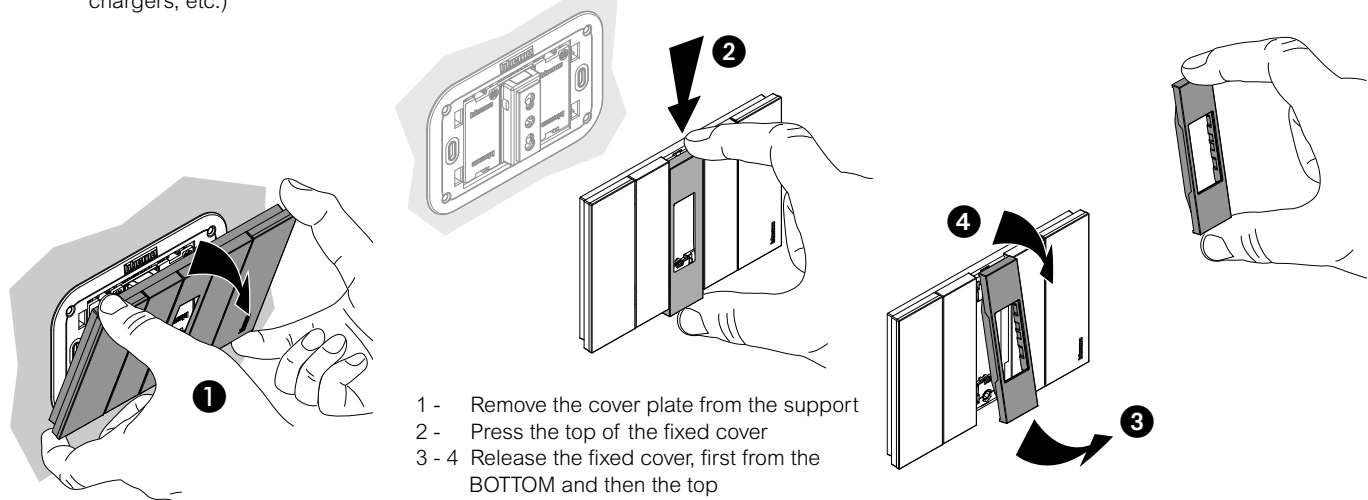

# Living Now

## DIMMER: load compatibility

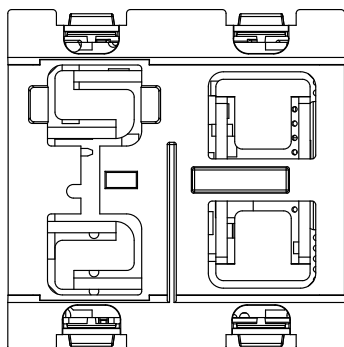

K4410  
K4411

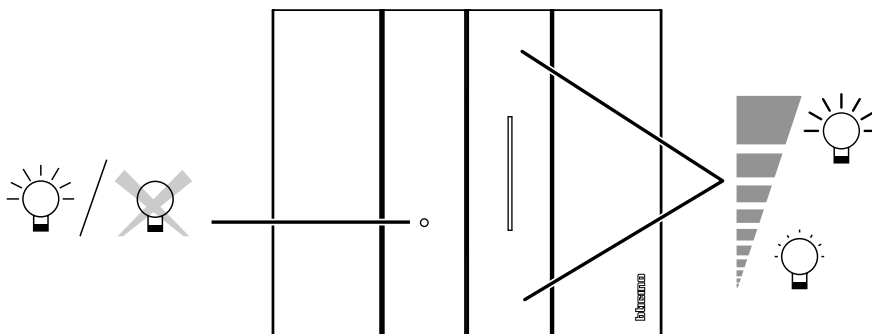

Switch the light on and off and bring the light to the desired level with a simple soft touch.  
Possibility of setting different brightness levels.  
ON/OFF notification LED.

### DIMMER ITEM K4410 - LOAD COMPATIBILITY

		1 -10 V		
  240 V ~ 50/60 Hz	Max	 600 VA	 600 VA	 600 VA
	Min.	20 VA	20 VA	20 VA

### DIMMER ITEM K4411 - LOAD COMPATIBILITY

		R		L		C/L			
  240 V ~ 50/60 Hz	Max.	 400 W	 400 W	 400 VA	 200 VA	 400 VA	 200 VA	Can be dimmed  75 W or max. 10 lamps	Can be dimmed LED  75 W or max. 10 lamps
	Min.	3 W	3 W	3 VA	3 VA	3 VA	3 VA	3 VA	3 W

ELECTRONIC ROOM THERMOSTAT ITEM KW4441-KG4441

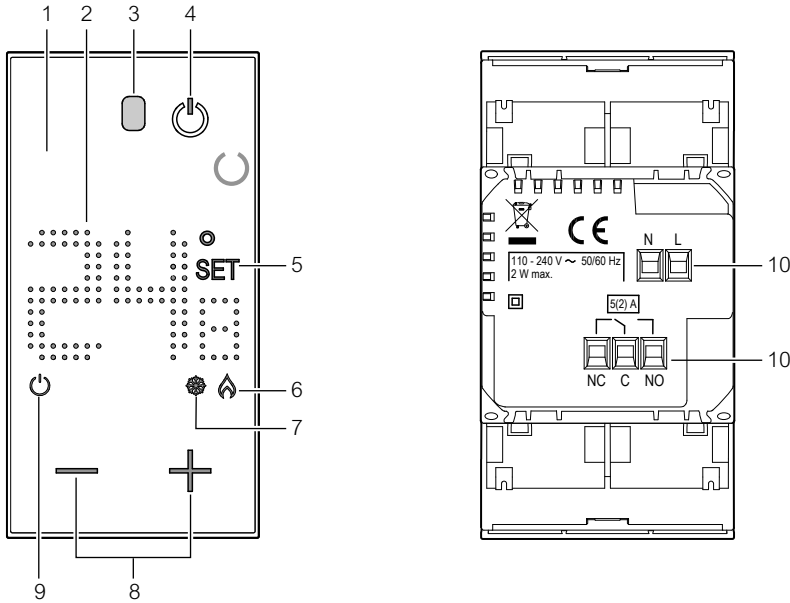

1. Backlit display
2. Temperature display
3. Lighting sensor
4. ON / OFF key sets the system (OFF) in anti-frost (7 °C) or heat-protection (35 °C) mode
5. Temperature setting indicator: appears when the temperature is being set
6. ON heating indicator
7. ON cooling indicator
8. Keys for temperature setting
9. OFF thermostat indicator
10. Connection clamps

Wiring diagrams

- System only for heating with clean contact (e.g. boiler activation) or heating and cooling with floor system

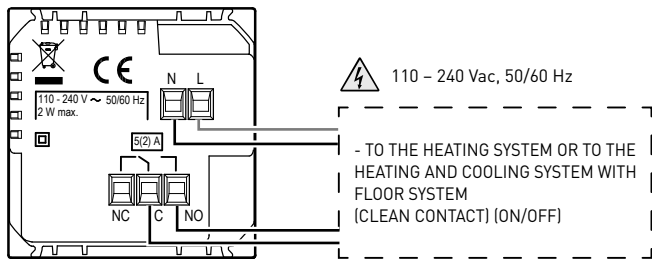

- Heating and cooling with different systems

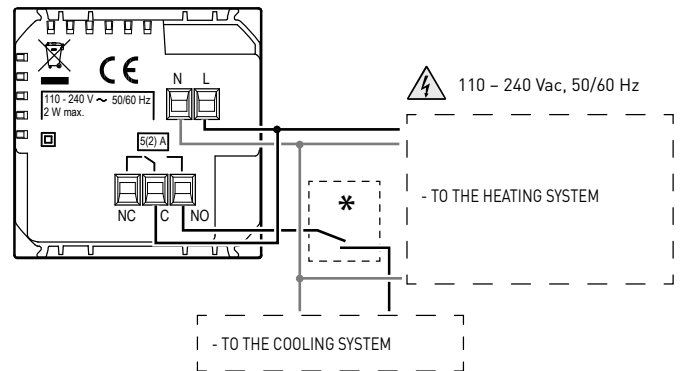

- System only for heating with load to be controlled to the mains voltage (e.g. 230Vac solenoid valve)

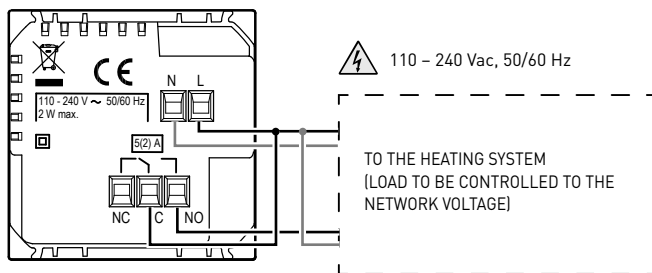

Technical features

Power supply	110 – 240 V $\sim$ , 50/60 Hz
Absorption	2 W max
Maximum cable section	1 x 1.5mm <sup>2</sup>
Operating temperatures	5 – 40 °C
Setpoint temperature	5 – 40 °C; increase of 0.5 °C
Type of operation	1BU
Pollution index	2
Rated pulse voltage	4 kV
Contact output	5(2) A



**Living Now**  
**devices for connected home**

Technical features for all devices

Technology: ZigBee certified product, Zigbee 3.0 public profile  
 Performance: 200 m range in a free point-to-point field  
 Band frequency: from 2.4 to 2.4835 GHz

CONNECTED TWO-WAY SWITCH ITEM K4003C

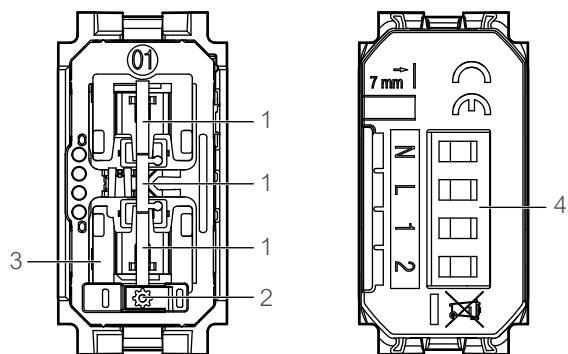

- 1 - Control pushbutton
- 2 - Setting pushbutton
- 3 - Notification LED
  - red steady: device not in Zigbee network
  - green steady: device in Zigbee network
- 4 - Connection clamps

Wiring diagram - interrupted

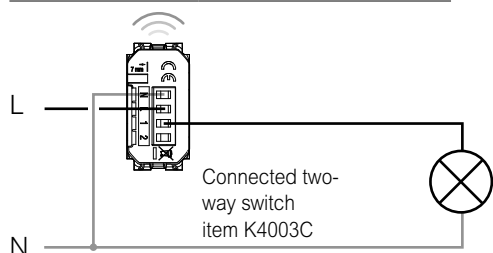

Wiring diagram - redirected or inverted

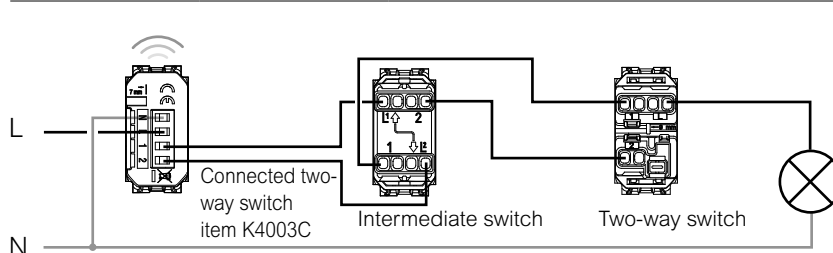

Load compatibility

 		<b>LED</b> 			
Loads	Filament lamp or halogen lamp	LED lamp	Fluorescent compact	Electronic transformer	Ferromagnetic transformer
240 V ~ 50/60 Hz	250 W	50 W	125 VA	125 VA	125 VA
Technology	ZigBee certified product, Zigbee 3.0 public profile				
Performances	200 m range in a free point-to-point field.				
Power level	REC 70-03: <20dBm				
Band frequency	from 2,4 to 2,4835 GHz				

**DIMMER ITEM K4411C**

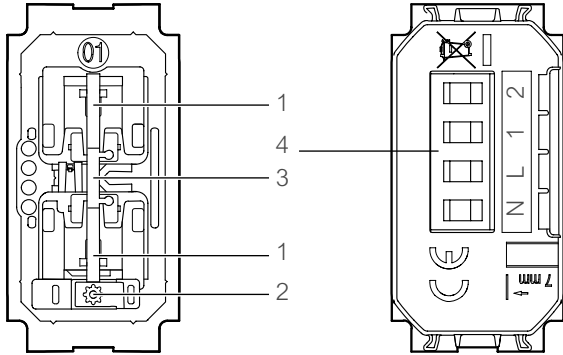

- 1 - Control pushbutton
- 2 - Reset pushbutton
- 3 - Notification LED
- 4 - Connection clamps

Basic diagram

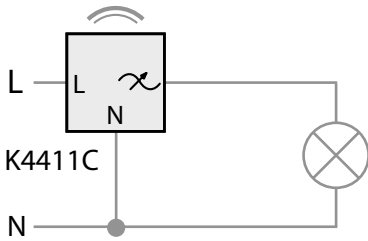
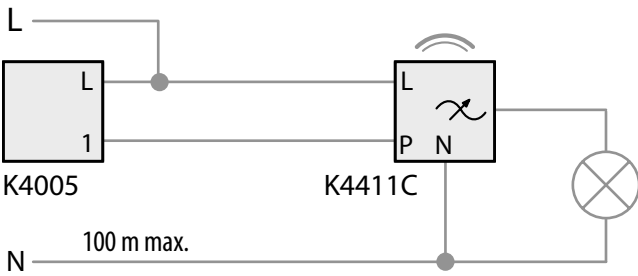

Diagram with remote control pushbuttons



Technical features

  110 - 240 V ~, 50/60 Hz	 Filament lamp or halogen lamp	 LED lamp
Loads	Filament lamp or halogen lamp	LED lamp
240 VAC	150 W	150 W
100 VAC	75 W	75 W
Technology	Radio (Wireless meshed network)	
Power level	< 100 mW	
Band frequency	from 2,4 to 2,4835 GHz	

**SHUTTERS CONTROL ITEM K4027C**

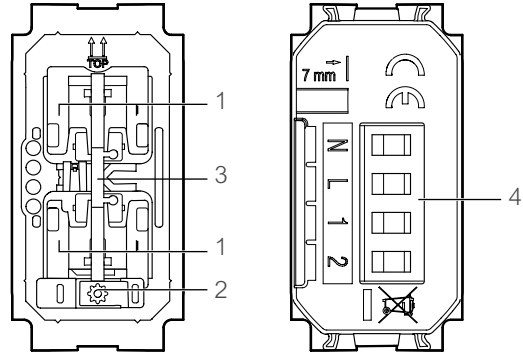

- 1 - Control pushbutton
- 2 - Reset pushbutton
- 3 - Notification LED
- 4 - Connection clamps

Wiring diagram - interrupted

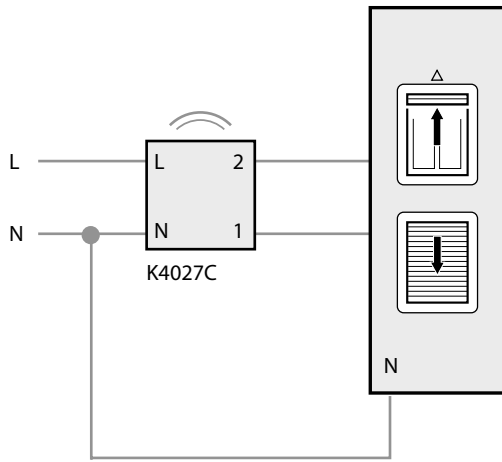

Warning: only compatible with standard motors (no pulse motors, no radio motors)

Technical features

  110 - 240 V ~, 50/60 Hz	
Loads	Motor for shutters
240 VAC max.	1 x 500 VA
100 VAC max.	1 x 270 VA
Technology	Radio (Wireless meshed network)
Power level	< 100 mW
Band frequency	from 2,4 to 2,4835 GHz

**Living Now**  
Connected light relay

CONNECTED LIGHT RELAY ITEM 574243

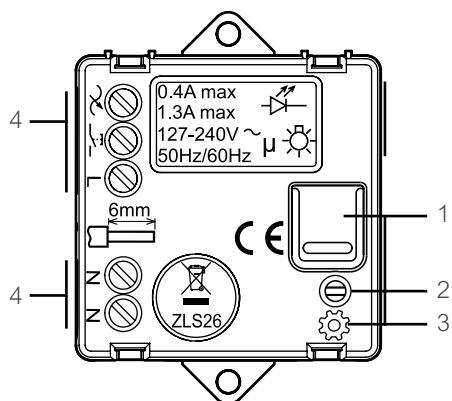

- 1 - Control pushbutton
- 2 - Setting pushbutton
- 3 - Notification LED
  - red steady: device not in Zigbee network
  - green steady: device in Zigbee network
- 4 - Connection clamps

Wiring diagram

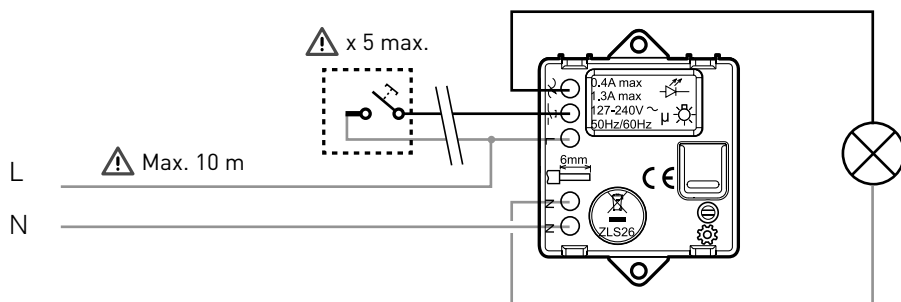

Option: remote control through mechanical pushbutton, not luminous.

Load compatibility

		R		L		
Loads	Filament lamp or halogen lamp	LED lamp	Fluorescent compact	Electronic transformer	Ferromagnetic transformer	
240 V ~ 50/60 Hz	Max.	300 W	(*) 100 W	250 VA	250 VA	

\* or 10 maxi. lamps

\*\* warning: ferromagnetic transformers must be charged at over 60% of their rated power.

CONNECTED MODULE FOR SOCKET ITEM K4531C

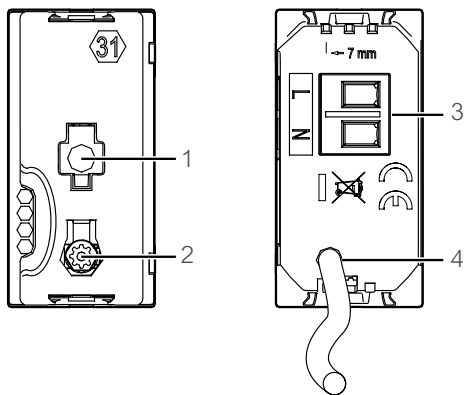

- 1 - notification LED
  - red steady: device not in Zigbee network
  - green steady: device in Zigbee network
- 2 - Setting pushbutton
- 3 - Connection clamps
- 4 - load controlled phase cable

Wiring diagram

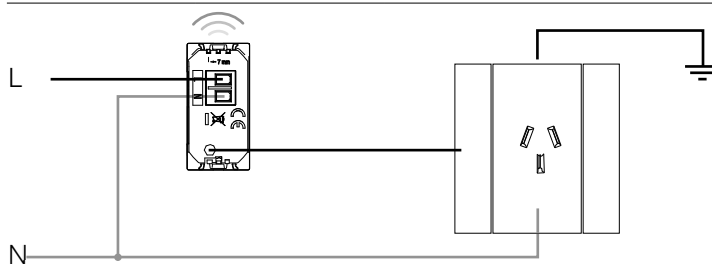

Load compatibility

Loads	Filament lamp	Halogen lamp	Electronic transformer	Ferromagnetic transformer	Fluorescent tube	Fluorescent compact	LED lamp	Ventilation motor
230 Va.c. 3800 W cos 0,8	16 A							

CONNECTED DIN METER ITEM 412015

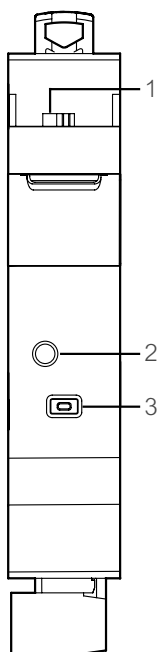

- 1 - Toroid connection
- 2 - notification LED
- 3 - Network association pushbutton

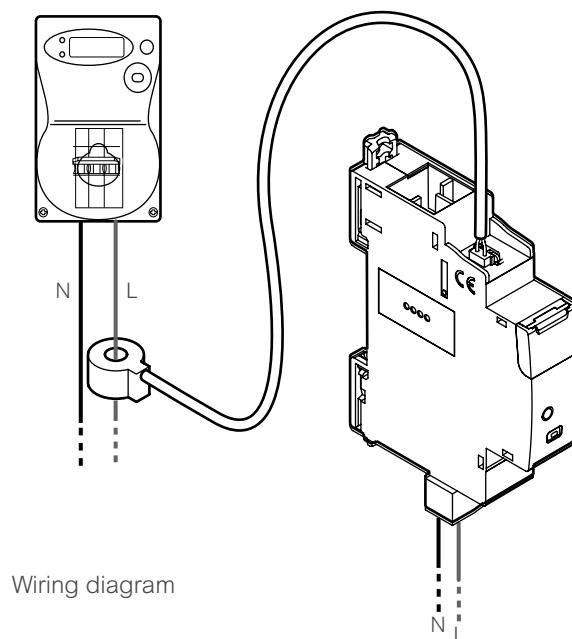

Wiring diagram

**Living Now**  
dimensional data

Living Now cover plates

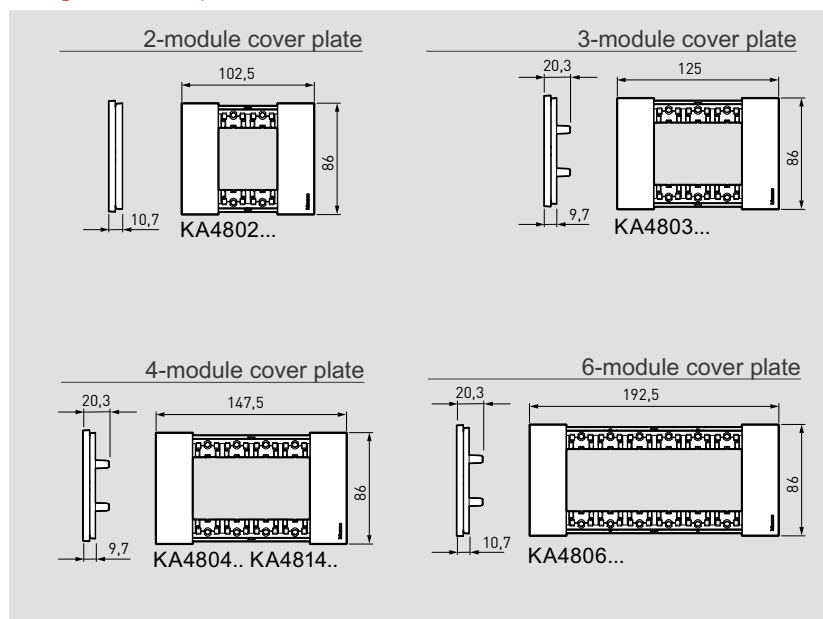

Living Now supports

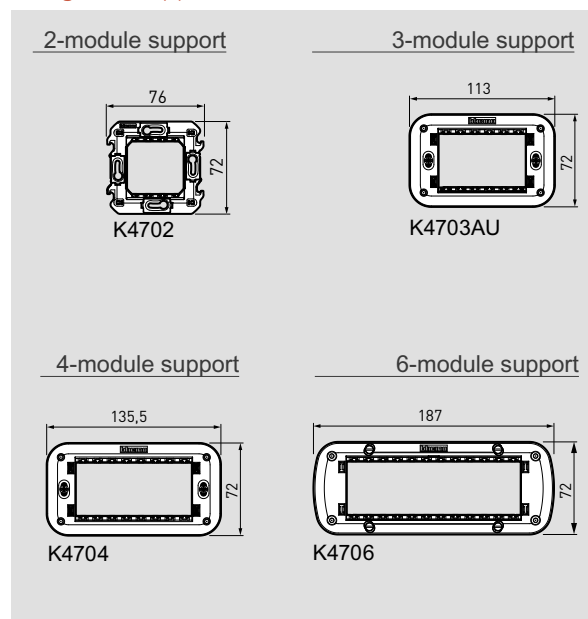

Living Now MyHOME\_Up BUS frames

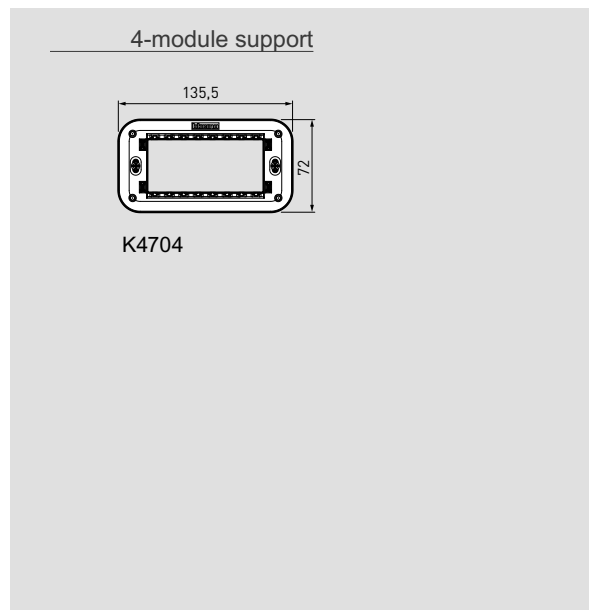
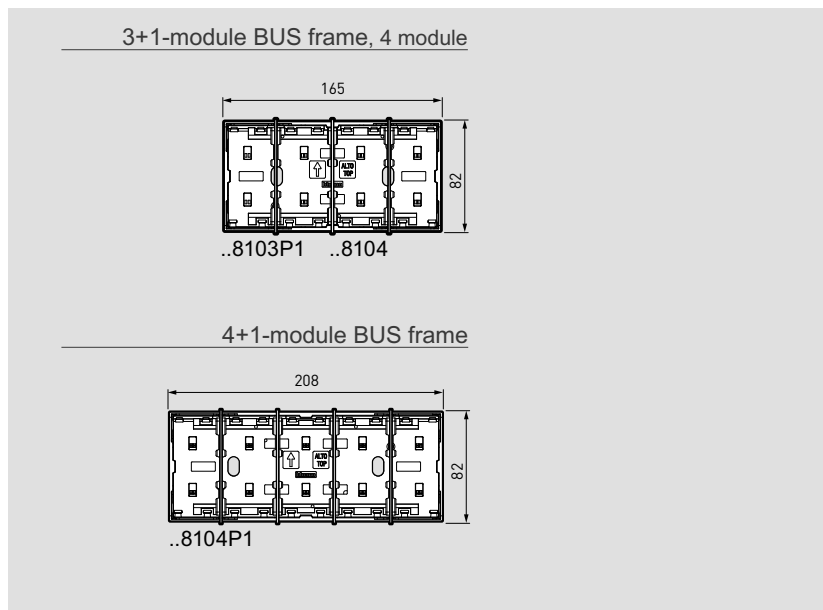
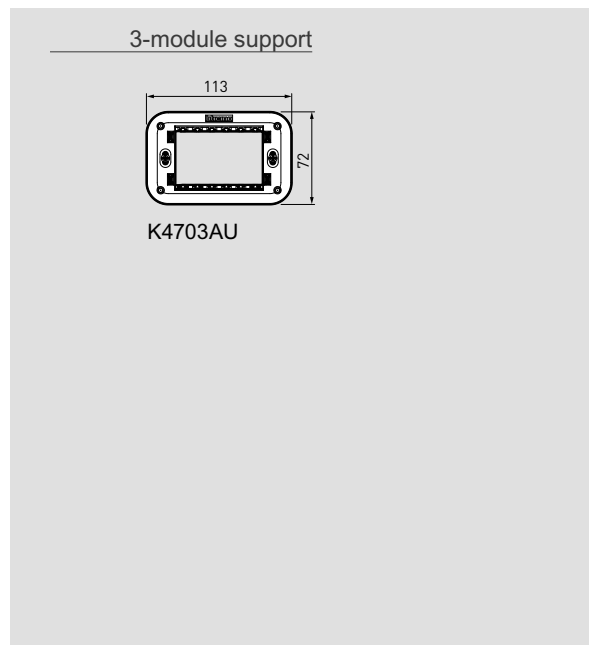
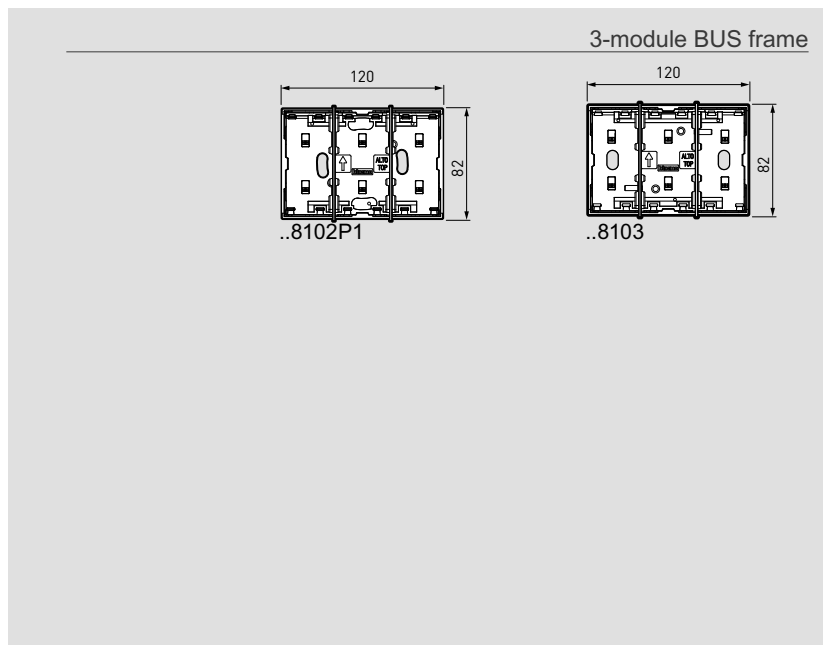

Smarter with Netatmo

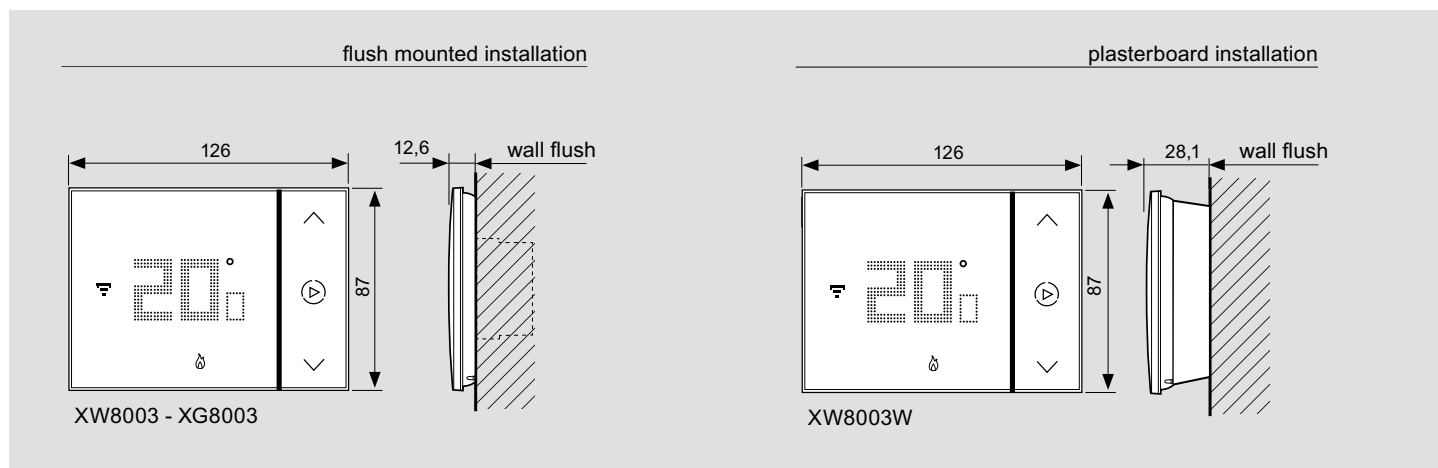

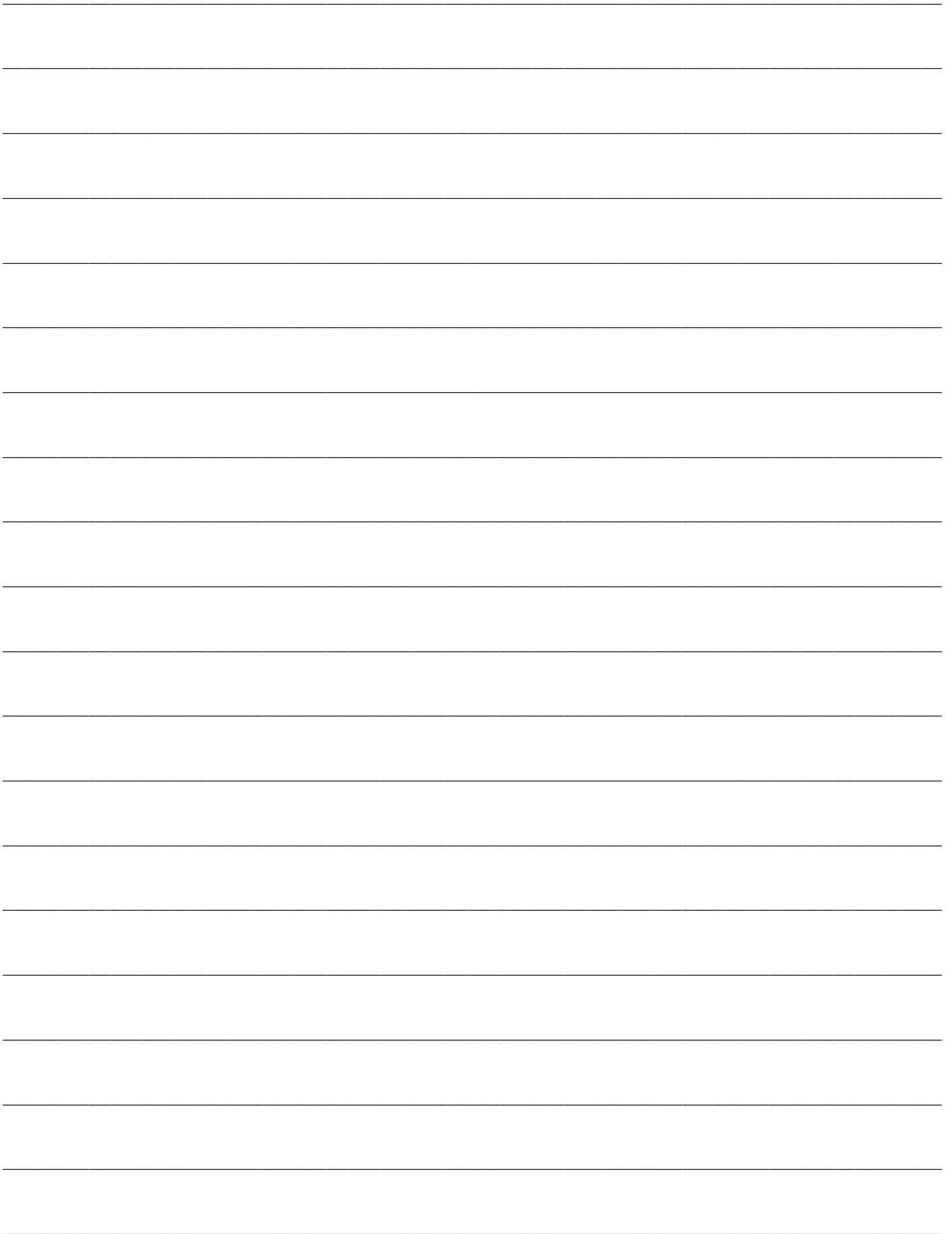



**Legrand Australia**

Building 4 Nexus Industry Park  
43-47 Lyn Pde Prestons NSW 2170  
1300 369 777  
[www.legrand.com.au](http://www.legrand.com.au)

**Legrand New Zealand**

106-124 Target Road Glenfield  
Auckland 0627 New Zealand  
0800 476 009  
[www.legrand.co.nz](http://www.legrand.co.nz)