

DIMR

*See current catalogue for further detail



Knob Styles available include:

DIMRKB
DIMRKBBK
DIMRKBMW
DIMRKBMBK
DIMRKBSN
DIMRKBSNSV

Cleaning Guide:

Spraying cleaning products on to electrical products is not recommended. It is important to ensure that switches are turned off before cleaning.

Do not use any cleaning sprays - only wipe down with damp cloth or rub with dry cloth. (Do not use an abrasive cloth as it may scratch the plastic).

Do not use harsh chemical cleaners as these can break down the plastic and cause it to crack.











Dimpala Universal Eclipse Dimmer

- Dimpala Eclipse Rotary Control Dimmer provides optimised dimming of LED lamps and drivers. This two-wire phase control [wall plate] dimmer has a minimum load rating of 2W.
- Although optimised for LED lighting loads, this dimmer also provides excellent compatibility with other common lamp types such as incandescent lamps and 12V halogen (dichroic) lamps / transformers.
- Fits Australian wall switch plate apertures (For example, the Trader range, plus #HPM and *Clipsal ranges).
- Separately switched 2-wire design - no neutral wire connection required for wallplate retrofit installation.
- Minimum brightness typical 0%.
- "Soft-start" helps prolong lamp and driver life.
- Inherent immunity to installation wiring short circuit fault.
- Complies with all relevant Australian standards.
- Features 'On' LED indicator.
- Mechanical Minimum Brightness setting by adjusting knob position on pot shaft.

Knob Style and Colours Available



Specifications	
Nominal Line Voltage Amplitude Range	220-240Vac
Line Voltage Frequency	50Hz Nominal (47 - 53Hz)
Load Brightness Control Range	< 1% to > 95% (load dependent)
Rated Load	Refer Compatible Loads
Minimum Load	2W

Compatible Load types			
Load Symbol	Load Type	Maximum Load	Notes
	Dimmable LED Drivers	400W	Maximum permitted number of drivers is 400W divided by driver nameplate power rating.
	Dimmable LED Lamps	400W	Due to variety of LED lamp designs, maximum number of LED lamps is further dependent on power-factor result when connected to dimmer.
	Electronic Transformers	400W	
	Standard iron-core transformers	250W	Due to variety of transformer designs, max LV lighting load is further dependent on transformer efficiency
	Toroidal iron-core transformers	300W	
	Incandescent	400W	
	Dimmable CFLs	200W	Due to the variety of CFL designs, the maximum number of dimmable CFL lamps is make/model dependent
M.3 	Small Motor Load	100W	

#HPM is a registered trademark of Legrand Aust. Pty. Ltd.

*Clipsal is a registered trademark of Schneider Electric (Australia) Pty. Ltd.

Certification Number:
GMA-509703

GSM Electrical (Australia) Pty Ltd
Level 2, 142-144 Fullarton Road, Rose Park SA 5067
P: 1300 301 838 F: 1300 301 778 E: service@gsm.com.au
www.gsm.com.au



DIMPR DIMPRX

*See current catalogue for further detail

PAGE 1 of 2



Knob Styles available include:

DIMPRKB
DIMPRKBBK
DIMPRKBMW
DIMPRKBMBK
DIMPRKBSN
DIMPRKBS
DIMPRKBZ
DIMPRKBZBK

Cleaning Guide:

Spraying cleaning products on to electrical products is not recommended. It is important to ensure that switches are turned off before cleaning.

Do not use any cleaning sprays - only wipe down with damp cloth or rub with dry cloth. (Do not use an abrasive cloth as it may scratch the plastic).









Do not use harsh chemical cleaners as these can break down the plastic and cause it to crack.



Dimpala Push Rotary Dimmers

Trader's NEW Dimpala PUSH Dimmer is mechanically switched and provides optimised dimming of LED lamps and drivers.

- 220-240Vac / 50Hz / 2W Min / 400W Max / <1% to > 95% (load dependent, see table below).
- Suitable for LED, incandescent and 12V dichroic lamps.
- Minimum dimming level, typically almost 0%.
- Push switch configuration with terminals similar to a standard switch for easy wiring.
- Integrated switch replaces the need for an additional control switch.
- Soft start for improved lamp & driver life.
- Thermal protection via NTC (negative temperature control).
- DIMPR is suitable for use with Australian wall plate apertures including Trader, HPM* & Clipsal*.
- Can be two way switched, but only one dimmer in the circuit

Specifications			
Nominal Line Voltage Amplitude Range	220-240Vac		
Line Voltage Frequency	50Hz Nominal (47 - 53Hz)		
Load Brightness Control Range	< 1% to > 95% (load dependent)		
Rated Load	Refer Compatible Loads		
Minimum Load	2W		
Compatible Load types			
Load Symbol	Load Type	Maximum Load	Notes
	Dimmable LED Drivers	400W	Maximum permitted number of drivers is 400W divided by driver nameplate power rating.
	Dimmable LED Lamps	400W	Due to variety of LED lamp designs, maximum number of LED lamps is further dependent on power-factor result when connected to dimmer.
	Electronic Transformers	400W	
	Standard iron-core transformers	250W	Due to variety of transformer designs, max LV lighting load is further dependent on transformer efficiency
	Toroidal iron-core transformers	300W	
	Incandescent	400W	
	Dimmable CFLs	200W	Due to the variety of CFL designs, the maximum number of dimmable CFL lamps is make/model dependent
M.3 	Small Motor Load	100W	



Catalogue Number	Description
DIMPR	Dimmer Push Rotary, White
DIMPRX	Dimmer Push Rotary Dimmer No Glow, White
DIMPRKBBK	Knob for Push Rotary Black Dimmer Knob, Black
DIMPRKBMW	Knob for Push Rotary Dimmer, Matt White
DIMPRKBMBK	Knob for Push Rotary Dimmer, Matt Black
DIMPRKBSN	Knob for Push Rotary Dimmer, Snow Leopard, Chrome Finish
DIMPRKBS	Knob for Push Rotary Saturn Dimmer Chrome Finish
DIMPRKBZ	Knob for Push Rotary Dimmer, Saturn Zen, White
DIMPRKBZBK	Knob for Push Rotary Dimmer, Saturn Zen, Black

Unless otherwise stated the identified trademarks and copyrights are the property of GSM Electrical (Australia) Pty Ltd.

*HPM is a registered trademark of Legrand Australia Pty Ltd.

*Clipsal and Saturn are registered trademarks of Schneider Electric (Australia) Pty Ltd. Reference is made for suitability of use only. GSM Electrical (Australia) Pty Ltd, the TRADER brand and it's products, have no endorsement or affiliation with Schneider Electric Pty Ltd. or Legrand Australia Pty Ltd.

Certification Number:

GMA-501086-EA

GSM Electrical (Australia) Pty Ltd

Level 2, 142-144 Fullarton Road, Rose Park SA 5067

P: 1300 301 838 F: 1300 301 778 E: service@gsme.com.au

www.gsme.com.au



DIMPR DIMPRX

*See current catalogue for further detail

PAGE 2 of 2

Knob Styles available include:

DIMPRKB
DIMPRKBBK
DIMPRKBMW
DIMPRKBMBK
DIMPRKBSN
DIMPRKBS
DIMPRKBZ
DIMPRKBZBK

Cleaning Guide:

Spraying cleaning products on to electrical products is not recommended.

It is important to ensure that switches are turned off before cleaning.

Do not use any cleaning sprays - only wipe down with damp cloth or rub with dry cloth. (Do not use an abrasive cloth as it may scratch the plastic).

Do not use harsh chemical cleaners as these can break down the plastic and cause it to crack.



Dimpala Push Rotary Dimmers

Setting minimal brightness level

Step 1

Leave the dimmer connected, but remove the dimming knob/button from dimmer shaft.

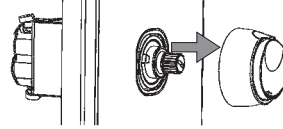

Step 2

Turn the dimmer shaft anti-clockwise until the required minimum brightness level is reached while lights are on. Then align the knob with the spline so that the small stops are next to each other and push the knob back into position. The knob should sit correctly on the plate and the push button should function as shown below.

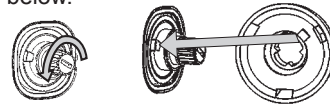

Setting LED Colour

Step 3

Backlighting colours available are green (standard), blue and off

To set colour:

- Press central button consecutively 5 times (can remove knob for easier viewing)
- Light will flash and cycle from green to blue to white (white represents no illumination) then cycle again
- Press the central button when preferred colour is shown to set
- The process must be repeated to reset the colour if there has been a black out or the circuit has been switched off at the switch board.

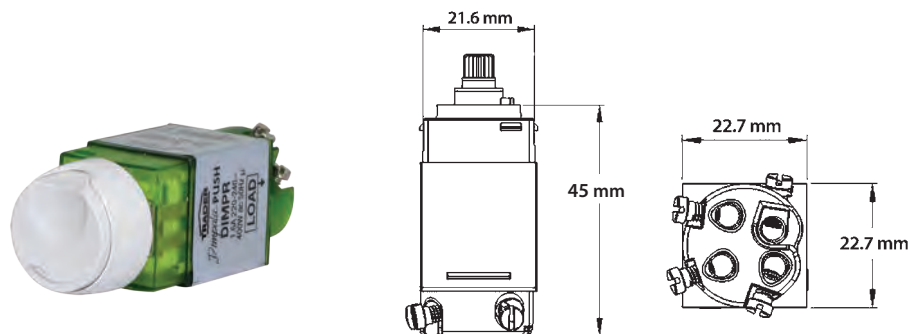
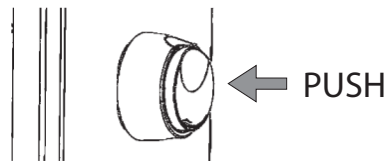

Certification Number:

GMA-501086-EA

GSM Electrical (Australia) Pty Ltd

Level 2, 142-144 Fullarton Road, Rose Park SA 5067

P: 1300 301 838 F: 1300 301 778 E: service@gsme.com.au

www.gsme.com.au



DIMPBD



Dimpala
DIMPBD

CAN BE USED IN CONJUNCTION WITH:
MEPBMW Push Button for Multi-Way Remote Dimming and On/Off switching



BUTTON CAPS:
MEBUMW
MEBUMBK
MEBUC
MEBUCBK
MEBUCMW
MEBUCMBK

Cleaning Guide:

Spraying cleaning products directly on to electrical switches or power points (sockets) is not recommended.

It is important to ensure that switches are turned off before cleaning.

Do not use any cleaning sprays - only wipe down with damp cloth or rub with dry cloth. Do not use an abrasive cloth as it may scratch the plastic.

Do not use harsh chemical cleaners as these can break down the plastic and cause it to crack.



Push Button Dimming

DIMPBD Push Button, Digital Dimmer, Trailing Edge

FEATURES

- DIMPBD Push Button Digital Dimmer and ON/OFF switch in one - perfect for dimmable LED.
- Multi-Way Dimming and Switching when used in conjunction with MEPBMW slave unit. Push Button Multi-Way Remote.
- Wider range - Deep Dimming to Zero on most lamps.
- Programmable minimum brightness.
- Double tap when ON - lights dim down to OFF over 30 minutes.
- Double tap when OFF - turn lights ON at previous level and ramps to full brightness over 30 minutes.
- Restarts OFF and retains settings after power loss.
- Improved patented ripple tone filtering.
- Rugged Over Current, Over Voltage and Over Temperature protection.
- Illuminated LED - configurable.
- Trailing Edge dimming with linear response.
- Suits both Trader and Clipsal® wall plates.
- Supplied with MEBU Gloss White & Gloss Black buttons, suits Puma, Cougar & Flat Cat gloss finishes.
- NOT SUITABLE FOR FANS AND MOTORS.

OPERATING CONDITIONS

- Operating Voltage: 230-240Va.c. 50Hz
- Maximum Load: 350W (see table below)
- Minimum Load: 1W
- Maximum Current Capacity: 1.5A
- Connection Type: Flying leads with bootlace terminals
- Operating Temperature: 0 to +50 °C
- Certified Standard: AS/NZS 60669.2.1, CISPR15







Note: Operation at temperature, voltage or load outside of the specifications may cause permanent damage to the unit.

WHITE, BLACK, MATT WHITE & MATT BLACK BUTTONS AVAILABLE:

MEBUMW & MEBUMBK (curved button for Flat Cat),
MEBUC & MEBUCBK (flat button for Leopard and Snow Leopard),
MEBUCMW & MEBUCMBK (flat button for Clouded Leopard)



LOAD COMPATIBILITY

LOAD TYPE	LOAD SYMBOL	MAXIMUM LOAD
Dimmable LED Lamps ⁽¹⁾		250W
Incandescent / 240V Halogen / Dichroic Lamps		350W
Low Voltage Halogen / Dichroic Lighting with Iron-Core Transformers ⁽¹⁾		250W
Low Voltage Halogen / Dichroic Lighting with Electronic Transformers ⁽¹⁾		350W
Dimmable Compact Fluorescent Lamps ⁽¹⁾		150W
Motors / Fans		Not Compatible
Non-Dimmable Fluorescent / Compact Fluorescent Lamps		Not Compatible

⁽¹⁾ Refer to lamp manufacturer's guidelines.

⁽²⁾ Compatible with Atco & Clipsal® transformers when loaded to at least 75% of their rated output.

WIRING INSTRUCTIONS

WIRING

- Disconnect power at the circuit breaker before any electrical work.
- Install the DIMPBD as per the wiring diagram in figure below.

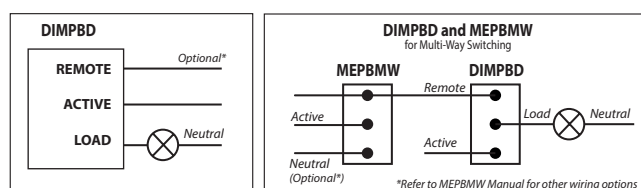

*The Clipsal brand and associated products are Trademarks of Schneider Electric (Australia) Pty Ltd. and used for reference only

Certification Number: GMA-503779-EA

GSM Electrical (Australia) Pty Ltd

Level 2, 142-144 Fullarton Road, Rose Park SA 5067

P: 1300 301 838 F: 1300 301 778 E: service@gsm.com.au

www.gsm.com.au

