



## Main

Range of product	Telemecanique Pressure sensors XM
Product or component type	Electromechanical pressure sensor
Pressure sensor type	Electromechanical pressure sensor
Device short name	XMLA
Pressure rating	300 bar
Controlled fluid	Hydraulic oil (0...160 °C)
Fluid connection type	G 1/4 (female) conforming to ISO 228
Electrical connection	1 male connector EN 175301-803-A (ex DIN43650), 4 pins
Contacts type and composition	1 C/O
Product specific application	-
Pressure switch type of operation	Detection of 1 single threshold
Electrical circuit type	Control circuit
Scale type	Fixed differential
Local display	With
Adjustable range of switching point on rising pressure	20...300 bar
Adjustable range of switching point on falling pressure	3.5...265 bar
Maximum permissible accidental pressure	675 bar
Destruction pressure	1350 bar
Pressure actuator	Piston
Materials in contact with fluid	Brass Steel FPM, FKM PTFE
Enclosure material	Zinc alloy
[In] rated current	3 A, B300, AC-15 (Ue = 120 V) conforming to EN/IEC 60947-5-1 1.5 A, B300, AC-15 (Ue = 240 V) conforming to EN/IEC 60947-5-1 0.1 A, R300, DC-13 (Ue = 250 V) conforming to EN/IEC 60947-5-1

## Complementary

Natural differential at low setting	16.5 bar (+/- 3 bar)
Natural differential at high setting	35 bar (+/- 6 bar)
Maximum permissible pressure - per cycle	375 bar
Terminal block type	4 terminals
Maximum operating rate	60 cyc/mn
Repeat accuracy	2 %
[Ui] rated insulation voltage	300 V conforming to UL 508 500 V conforming to EN/IEC 60947-1 300 V conforming to CSA C22.2 No 14
[Uimp] rated impulse withstand voltage	6 kV conforming to EN/IEC 60947-1

The information provided in this documentation contains general descriptions and/or technical characteristics of the performance of the products contained herein. This documentation is not intended as a substitute for and is not to be used for determining suitability or reliability of these products for specific user applications. It is the duty of any such user or integrator to perform the appropriate and complete risk analysis, evaluation and testing of the products with respect to the relevant specific application or use thereof. Neither Schneider Electric Industries SAS nor any of its affiliates or subsidiaries shall be responsible or liable for misuse of the information contained herein.

Auxiliary contacts operation	Snap action
Contacts material	Silver contacts
Maximum resistance across terminals	25 MOhm conforming to IEC 255-7 category 3 25 mOhm conforming to NF C 93-050 method A
Short-circuit protection	10 A cartridge fuse, type gG (gl)
Mechanical durability	3000000 cycles
Setting	External
Height	113 mm
Depth	75 mm
Width	35 mm
Net weight	0.78 kg





## Environment

Standards	UL 508 EN/IEC 60947-5-1 CSA C22.2 No 14 CE
Product certifications	BV LROS (Lloyds register of shipping) EAC CSA CCC UL
Protective treatment	TC standard version
Ambient air temperature for operation	-25...70 °C
Ambient air temperature for storage	-40...70 °C
Operating position	Any position
Vibration resistance	4 gn conforming to IEC 60068-2-6 (f = 30...500 Hz)
Shock resistance	50 gn conforming to IEC 60068-2-27
Electrical shock protection class	Class I conforming to IEC 1140 Class I conforming to IEC 536 Class I conforming to NF C 20-030
IP degree of protection	IP65 conforming to EN/IEC 60529

## Packing Units

Unit Type of Package 1	PCE
Number of Units in Package 1	1
Package 1 Weight	785.0 g
Package 1 Height	4.0 cm
Package 1 width	12.0 cm
Package 1 Length	11.5 cm
Unit Type of Package 2	S02
Number of Units in Package 2	13
Package 2 Weight	10.508 kg
Package 2 Height	15.0 cm
Package 2 width	30.0 cm
Package 2 Length	40.0 cm

## Offer Sustainability

Sustainable offer status	Green Premium product
REACH Regulation	 <a href="#">REACH Declaration</a>
EU RoHS Directive	Pro-active compliance (Product out of EU RoHS legal scope)  <a href="#">EU RoHS Declaration</a>
Mercury free	Yes
RoHS exemption information	 <a href="#">Yes</a>
Environmental Disclosure	 <a href="#">Product Environmental Profile</a>

## Contractual warranty

---

Warranty	18 months
----------	-----------

---

Dimensions

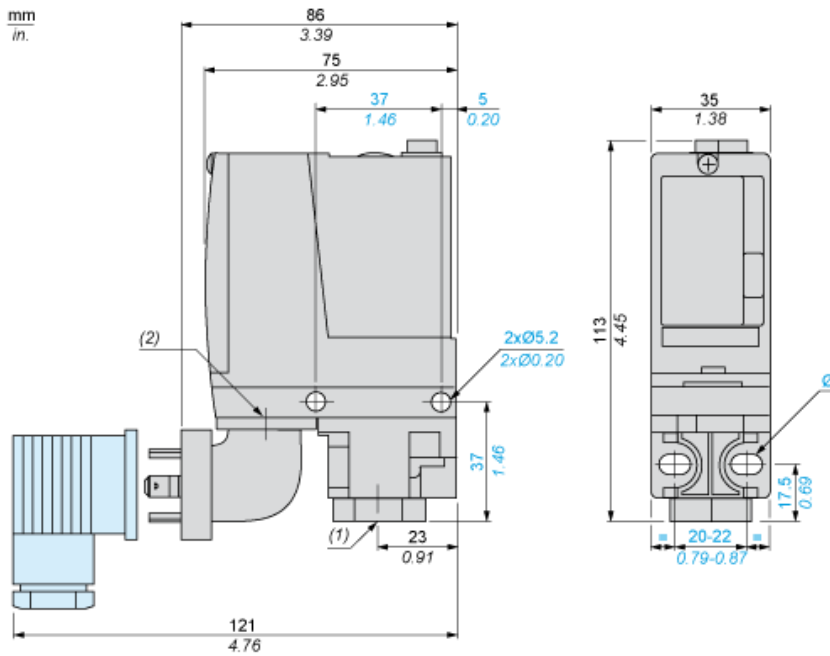

- (1) 1 fluid entry, tapped G1/4 (BSP female)
- (2) EN 175301-803-A connector
- Ø : 2 elongated holes Ø 5.2 x 6.7

---

## Wiring Diagram

---

### Terminal Model



---

## Wiring Diagram

---

### Vacuum Switch Connector Pin View



- (1) 11 and 13
- (2) 12
- (3) 14

Operating Curves

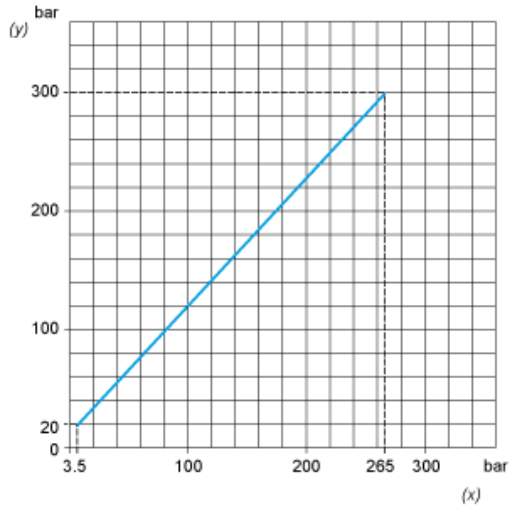

(y) Rising pressure  
(x) Falling pressure

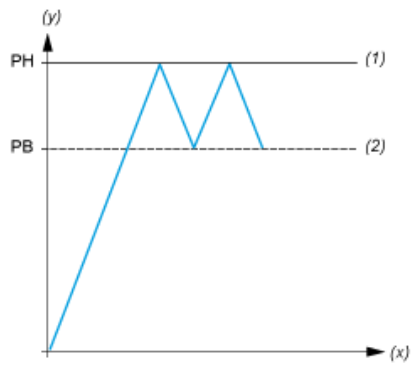

(y) Pressure  
(x) Time  
(1) Adjustable value  
(2) Non adjustable value  
PH : High point  
PB : Below point