



 COOLON

BULKHEAD / EM BULKHEAD

35W/42W Bulkhead Light

High performance, versatile, retrofit compatible bulkhead light

The Bulkhead is a high performance and versatile light that has been carefully engineered with feedback from mining maintenance crews to ensure easy installation of a robust and virtually indestructible luminaire

Designed for use in:

- Exit Routes
- Platforms
- Walkways
- Stairwells
- Substation
- Tunnels
- Conveyors



Designed with the installer in mind

Multiple entry points, easily-accessible terminal block, and removable body. All these aspects make installation a breeze. "Straight off, straight on!"

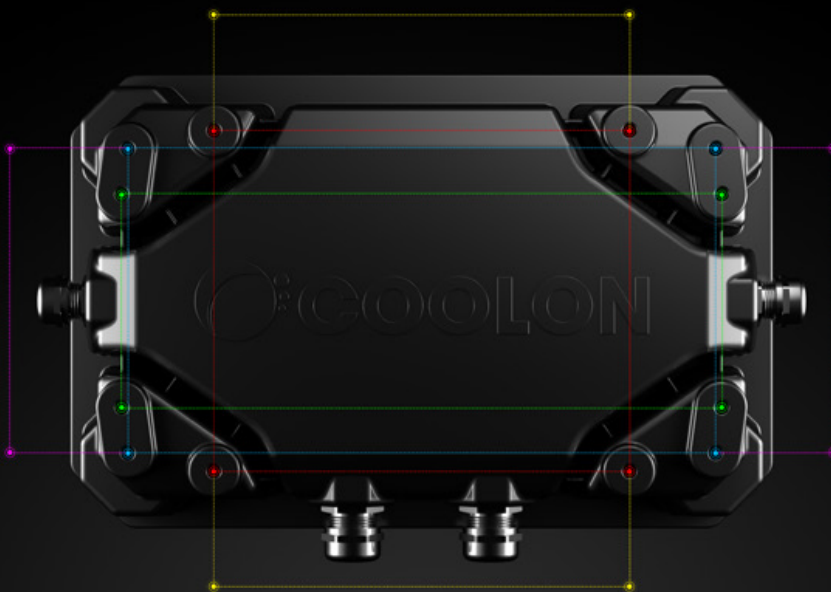
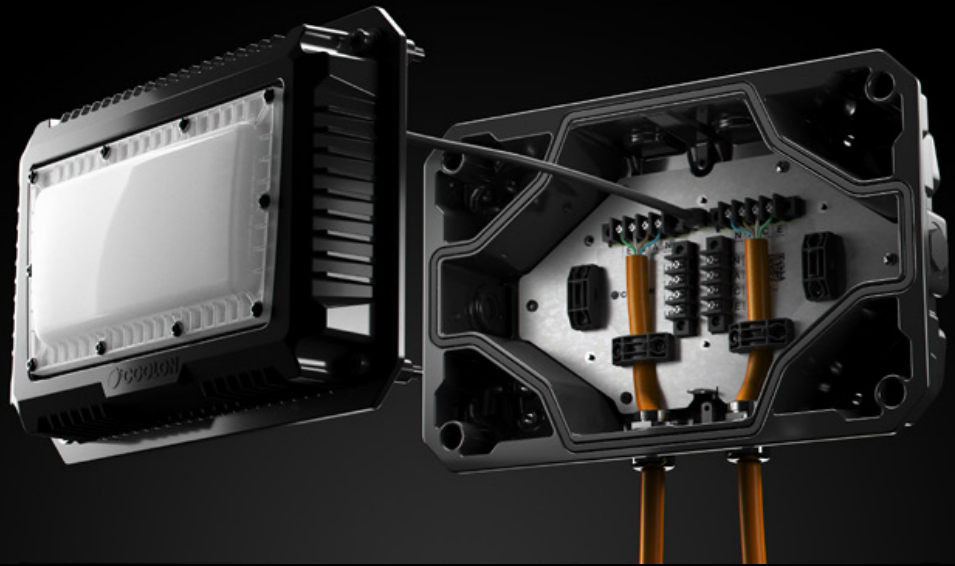

Universal mount design

Designed with a universal mount to retrofit the hole patterns of most common bulkhead lights on the market, the Coolon Bulkhead is easy and quick to install.



COOL SURFACE TEMPERATURE

Coolon's Industrial LED fittings have a much lower surface temperature than traditional HID equivalents which prevents dirt from baking onto the luminaire. This allows for easier cleaning and will prolong the lifespan of the luminaire.



NO FLICKERING

LED luminaires run on constant low voltage DC power and do not produce any visible stroboscopic effects, thus reducing the strain on eyes and significantly improving safety in areas where moving machinery is present.



LOW SUSCEPTIBILITY TO VIBRATION

This luminaire is designed to handle continuous exposure to vibration. A typically critical issue affecting the life and operation of most common gas discharge lamp based light sources is mechanical shock and vibration.

3
YEARS

3 YEARS FACTORY WARRANTY

Coolon Luminaires are covered by a solid comprehensible manufacturer's warranty that covers a range of possible defects and performance parameters throughout the duration of the warranty period.



INSTANT ON/OFF

LEDs do not require warm up. Instant on to 100% output translates to no downtime, improved safety and the ability to utilize sensor switching to significantly save energy.

IP66

HIGH IP RATING - IP66

Coolon's Industrial LEDs are designed specifically to withstand the harsh conditions in mining environments. The robust design allows our LED products to be used in many different applications and are high pressure washable.

L70

LONG USEFUL OPERATING LIFE

Currently available specification from world's most reputable LED manufacturers states 50,000 hours of continuous operation at the rated current within the operating temperature range to 70% residual light output.



PROUDLY MADE IN AUSTRALIA

Our products are designed and manufactured in Australia. Engineered to perfection, using only the highest quality components and highly skilled labour, each luminaire is assembled and thoroughly tested to ensure that it exceeds the highest standards.

DIMENSIONS

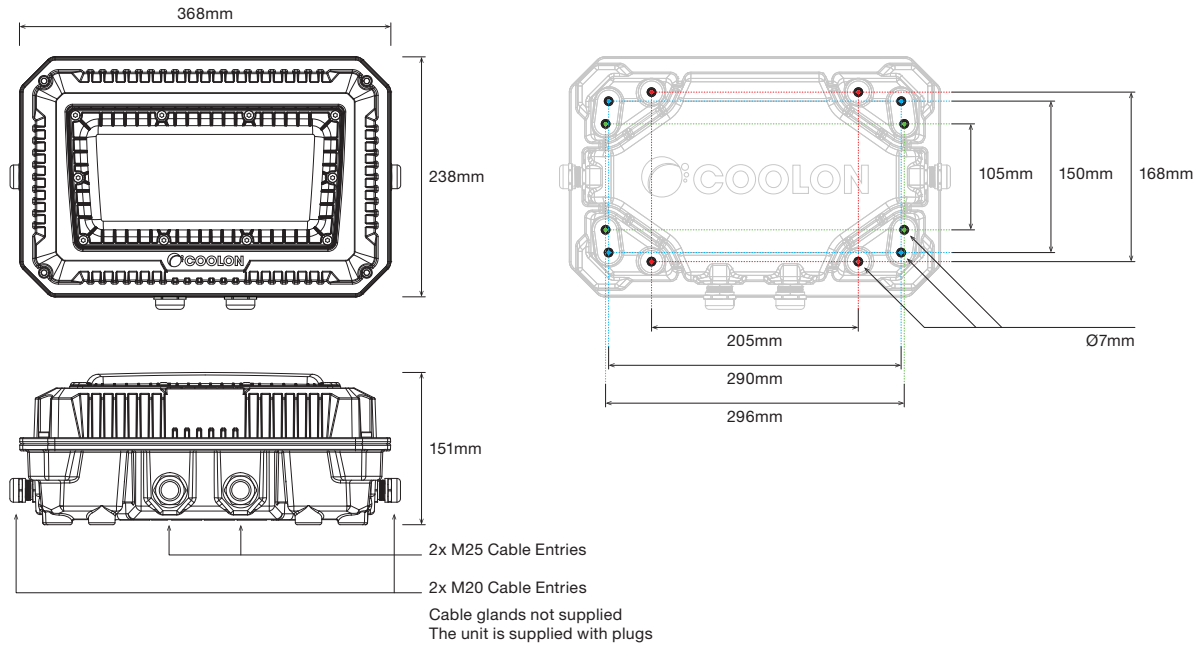

ACCESSORIES

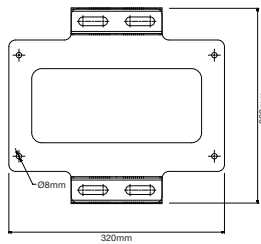

Optional Bulkhead Pole Mounting Bracket
(available separately) refer to industrial accessories brochure. visit coolon.com.au to download now.

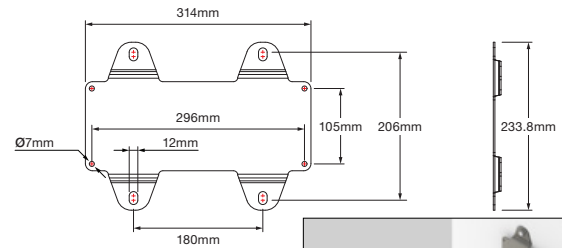

Optional Versalux EBH Adapter Plate
(available separately) refer to industrial accessories brochure. visit coolon.com.au to download now.

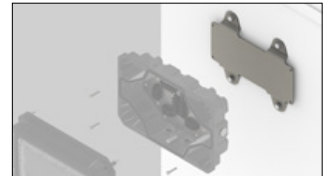

TECHNICAL SPECIFICATIONS

Product	Bulkhead Industrial LED	
Model	BH	EMBH
Optical Characteristics		
Luminous Flux (Photometered)	4,236 lm	3,160 lm (MP Mode)
CCT	CWT / WWT / AMB	
CRI	>70 excluding amber	
Electrical Characteristics (Luminaire)		
Power Consumption	35W	42W
Nominal Voltage	230VAC	230VAC
Voltage Range	180 – 440VAC 254 – 550VDC	90 – 277VAC 127 – 350VDC
Frequency Range	47 – 63Hz	47 – 63Hz
Power Factor	≥0.98 / 230VAC	≥0.95 / 230VAC
Leakage Current	<0.75mA / 480VAC	<0.75mA / 277VAC
Environmental		
IP Rating	IP66	
Impact Rating	IK09	
Salt Spray Tested	Yes	
Operating Temp. Range	-20 to +50°C	0 to +50°C
Thermal Management Type	Active/Continuous	
Expected Lifespan	50,000 Hours to 70% Brightness	
Material Composition (Body)	ADC12 Aluminium Alloy	
Material Composition (Cover)	Polycarbonate	
Cable Entry Options	2x M20 + 2x M25	

Weight/Packaging		
Luminaire Weight	5.6kg	6.8kg
Packaging Dimensions	L 400mm x W 280mm x D 180mm	
Packaged Weight	6.1kg	7.3kg

Compliance (Safety Standards)		
AS/NZS60598.1	Luminaires - General Requirements and Tests	
AS/NZS 60598.2.1	Luminaires - Particular requirements - Fixed general purpose luminaires	

Compliance (EMC)		
AS/NZS CISPR15	Limits and methods of measurement of radio disturbance characteristics of electrical lighting and similar equipment	

Warranty		
Warranty	3 years warranty as standard 5 years extended warranty optional	

¹ Optical and electrical characteristics are measured using Cool White LEDs (CWT)
² Reading taken while test unit operating in steady state. Ambient temperature during testing is typically 25°C. Individual unit behaviour may differ due to electronic component tolerance and ambient conditions. Product parameters and application suitability shall be checked by the user prior to commissioning.

COLOUR TEMPERATURES



All colour temperatures are indicative. Some variation can occur.

OPTICAL DISTRIBUTION

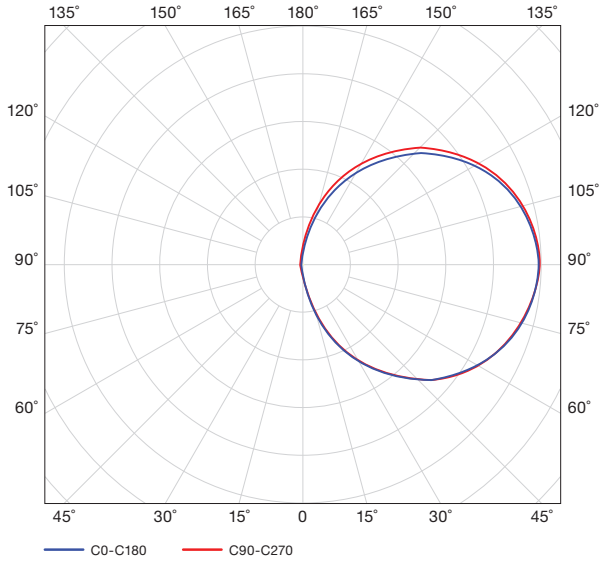

EMERGENCY BH (EMBH)

The EMBH utilises a solid state integral emergency module. The emergency power is provided by safe LiFePO₄ cells with a host of intelligent management circuitry. The EMBH performs constant operational readiness tests, ensuring reliable emergency lighting will be available when needed. The onboard processor will notify the user should the unit ever need attention allowing operators to better utilise their time.

With a balance between performance, intelligence and reliability, the EMBH is the ultimate industrial integral EM luminaire.



ORDERING EXAMPLE

BH - CWT - SY1 - MP

PRODUCT COLOUR TEMP OPTICS SUPPLY OPTION

PRODUCT		COLOUR TEMP		OPTICS		SUPPLY OPTION	
BH	Bulkhead	CWT	Cool White	SY1	Symmetrical / Diffuser	MP	Mains Powered
EMBH	Emergency Bulkhead	WWT	Warm White				
		AMB	Amber				

CUSTOM UNITS ORDERING EXAMPLE

CST - BH - CWT - SY1 - MP - WMG

PRODUCT COLOUR TEMP OPTICS SUPPLY OPTION ACCESSORY

PRODUCT		COLOUR TEMP		OPTICS		SUPPLY OPTION		ACCESSORY	
CST-BH	Custom Bulkhead	CWT	Cool White	SY1	Symmetrical / Diffuser	MP	Mains Powered	WMG	Stainless Steel Wire Mesh Guard
		WWT	Warm White						
		AMB	Amber						



CST - BH - CWT - SY1 - MP - SHIELD

PRODUCT COLOUR TEMP OPTICS SUPPLY OPTION ACCESSORY

PRODUCT		COLOUR TEMP		OPTICS		SUPPLY OPTION		ACCESSORY	
CST-BH	Custom Bulkhead	CWT	Cool White	SY1	Symmetrical / Diffuser	MP	Mains Powered	SHIELD	Stainless Steel Light Shield
		WWT	Warm White						
		AMB	Amber						

