



CONNECTED HOME TECHNICAL GUIDE

Connected switches & sockets technical guide



Arteor[™]
with NETATMO

Living Now
WITH
Netatmo

Contents

02

Installation components

08

Installation tips

10

Example scenarios

12

Wiring diagrams

14

Setup
and pairing

16

Home + Control app

24

Catalogue pages

29

Compatibility



Arteor™
with NETATMO
SMART HOME MADE EASY



Living Now
WITH
Netatmo



INSTALLATION COMPONENTS

A smart home installation consists of wired products, which can be installed as new or retrofitted as a replacement for existing switches and powerpoints. Wireless switches can then be paired with wired products as shown in this table.

WIRED PRODUCTS

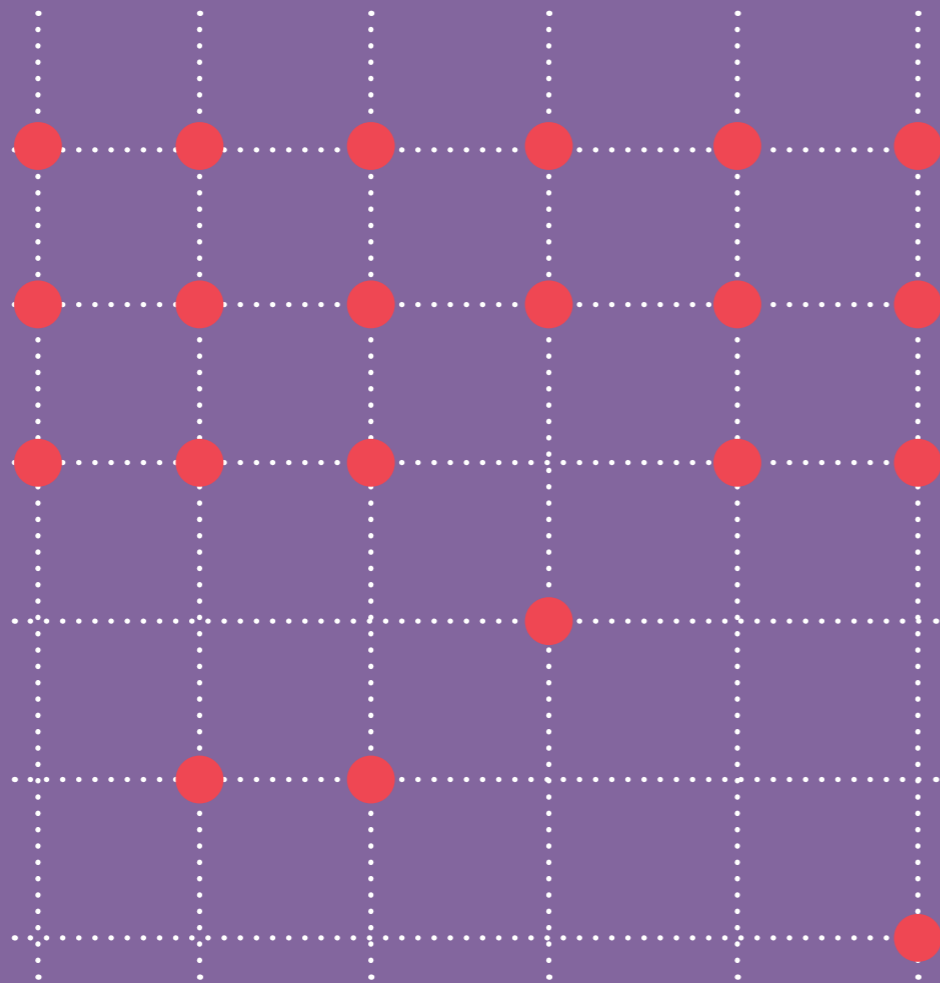
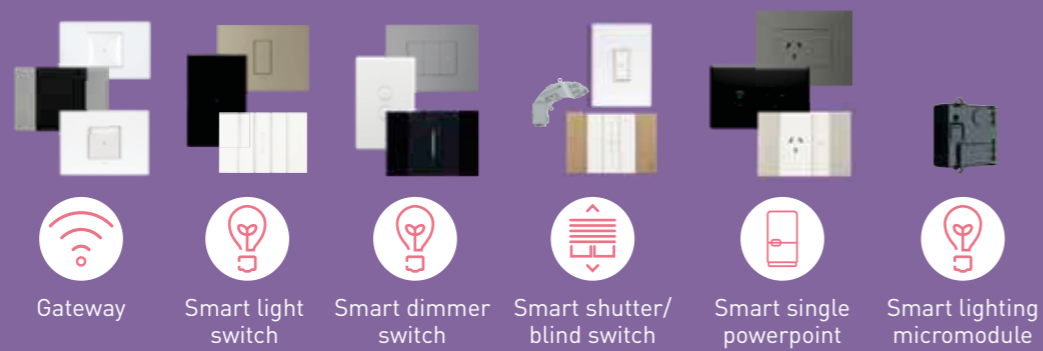

All the products communicate by means of Zigbee radio (2.4 GHz waveband). **Advantage: a dynamic mesh network!**

1

START THE INSTALLATION

CX3 WITH NETATMO



412181

ARTEOR WITH NETATMO STARTER KIT



AWNSKITWE



AWNBSKITWE

EXCEL LIFE WITH NETATMO STARTER KIT



EWNSKITWE

LIVING NOW STARTER KIT



K4510C

K4500C

2

EXTEND THE INSTALLATION

SMART WIRED PRODUCTS

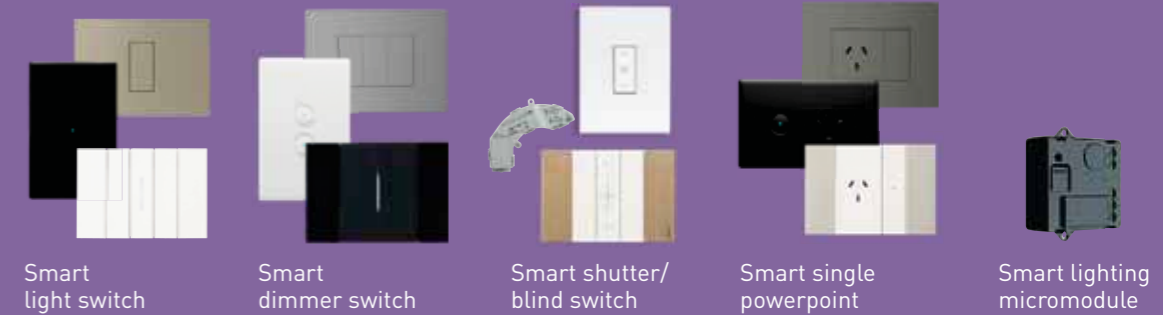

WIRELESS SWITCHES

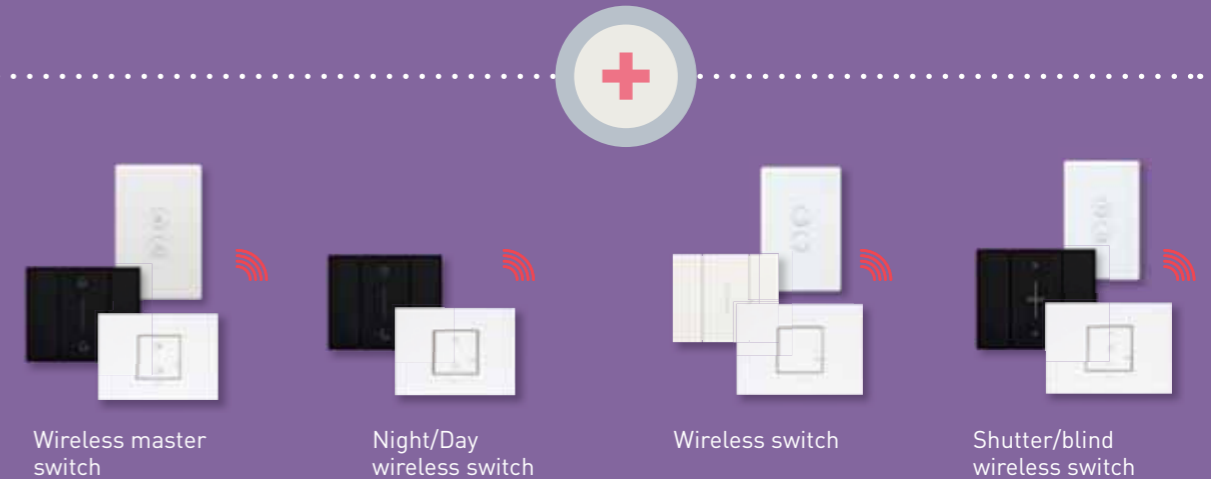

WIRELESS SWITCHES

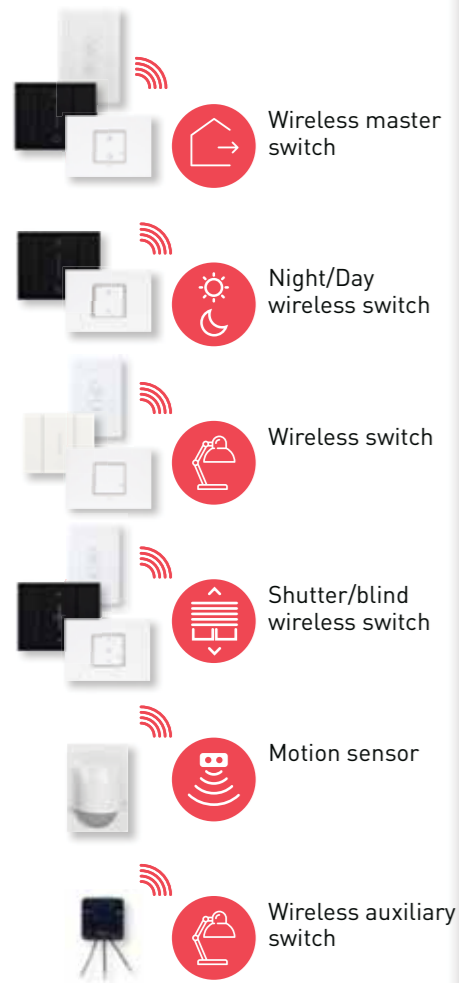

INSTALLATION COMPONENTS



CONNECTED GATEWAY

Install the gateway **close to an internet router** to optimise the Wi-Fi signal reception. The gateway then communicates with individual switches and sockets using Zigbee radio.

Just one gateway is needed per dwelling. It can control up to **100 wired and wireless products**.

There are 2 forms factors for the gateway:

1. A Wall-mount version which can replace a wall plate or outlet (same wiring and mounting centres) It is sold in the Starter kit or Basic kit, together with a wireless master switch.

2. A Din-rail mount version, to be installed inside a load centre or distribution board

The Din-rail version is sold on its own and does not require a wireless master switch (optional).

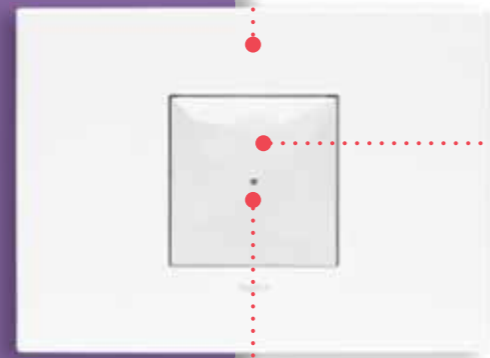

Wall-mount version

LED indicator



Din-rail mount version

STARTER KIT

Gateway establishes connection between router & other smart products



Unique setup code affixed to the product in order to use the Apple HomeKit app



WIRELESS MASTER SWITCH

Extra-slim, attached to the wall with the adhesive strips provided. It can be repositioned.

It is installed **near the entrance door** to control Home/Away scenarios involving lights, shutters and power outlets.

Sold both in the starter kit and individually, to be added if the house has more than one entrance. Customised scenarios should be identical on all the master switches.

Scenarios should be configured in the Home + Control app.

CR 2032 - 3V button battery supplied
Standby power: 8 years approx.*



SMART LIGHT SWITCH

Can **replace an existing switch**, with the same wiring and mounting centres.

Controls all types of conventional and dimmable bulbs, up to 100W for LEDs (or 10 lamps)



SMART DIMMER SWITCH

Can **replace an existing switch**: same wiring, same mounting centres. Requires a neutral (N) wire.

Controls all types of conventional and dimmable bulbs up to 150W.

Always use **dimmable LEDs**.

The dimmer functionality can be activated from the Home + Control app.



SMART LIGHTING MICROMODULE

To be installed near or **directly on the light source**. Used to provide connected lighting.

Controlled by one or more wireless switches and/or bell-press type pushbuttons when replacing a remote switch.

For all types of bulbs **up to 100W** for LEDs (or 10 lamps)

WIRED PRODUCTS



LED indicator for installation

Dimensions (with fixing lugs): 52x40x20mm

*dependent on daily usage.

INSTALLATION COMPONENTS



SMART SHUTTER/BLIND SWITCH

Can **replace an existing switch**: same wiring, same mounting centres. Compatible with **all wired shutter motors** with electronic or mechanical end stop.

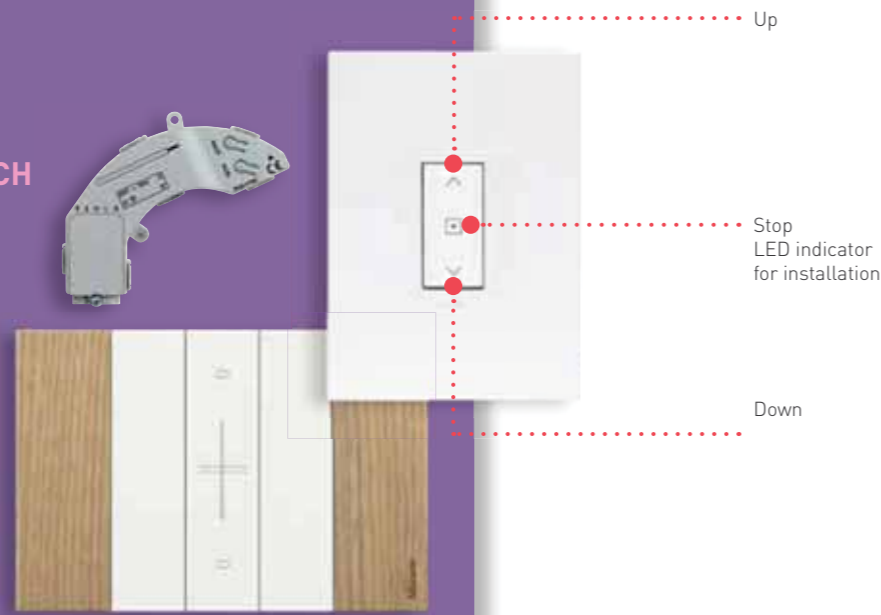

SMART SINGLE POWERPOINT - 10A

Can **replace an existing powerpoint**: same wiring, same mounting centres. The Smart powerpoint can measure the instantaneous and total power consumption. It is compatible with all electrical appliances, especially with large household appliances. **Extra built-in protection** in case of overloads of more than 10A.

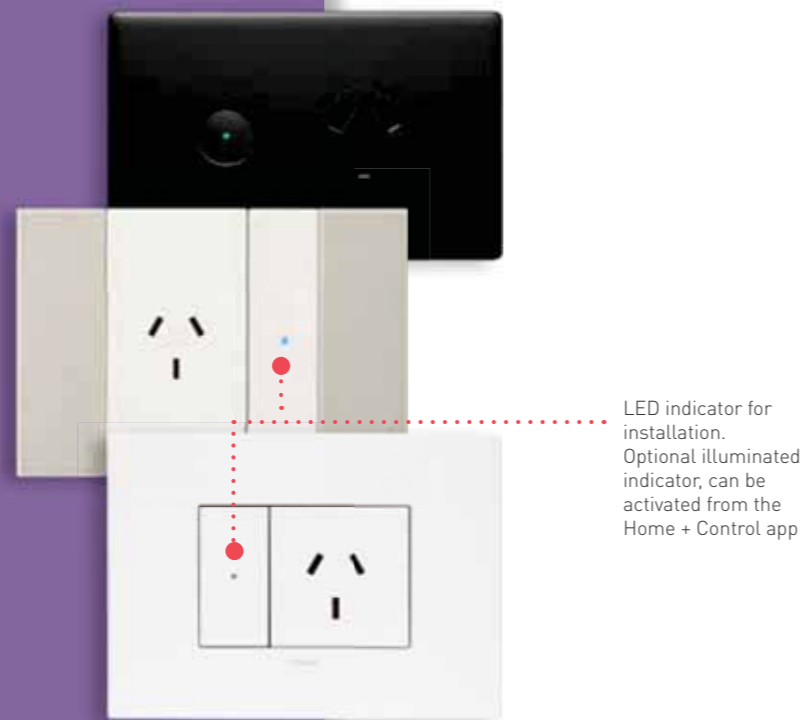

WIRED PRODUCTS



NIGHT/DAY WIRELESS SWITCH

Extra-slim, attached to the wall with the adhesive strips provided. It can be repositioned. Used to **create scenarios** involving lights, shutters and powerpoints at the time people wake up and go to sleep. Scenarios should be configured in the Home + Control app. CR 2032 - 3V button battery supplied. Standby power: 8 years approx.*



WIRELESS SWITCH

Extra-slim, attached to the wall with the adhesive strips provided. It can be repositioned. Controls smart light or dimmer switches, micromodules and smart powerpoints. CR 2032 - 3V button battery supplied. Standby power: 8 years approx.*



WIRELESS SHUTTER/BLIND SWITCH

Extra-slim, attached to the wall with the adhesive strips provided. It can be repositioned. Controls smart shutter/blind switches and can **centralise** control of several shutters. CR 2032 - 3V button battery supplied. Standby power: 8 years approx.*

WIRELESS SWITCHES

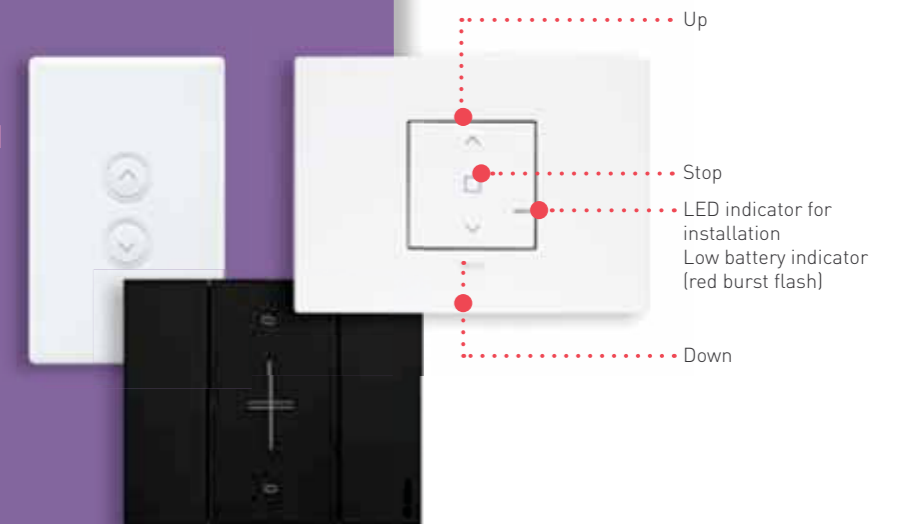
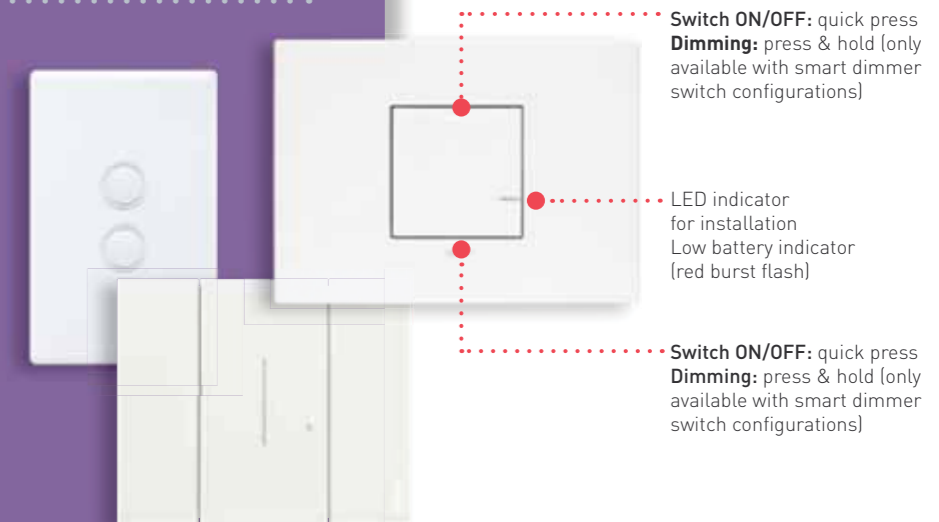
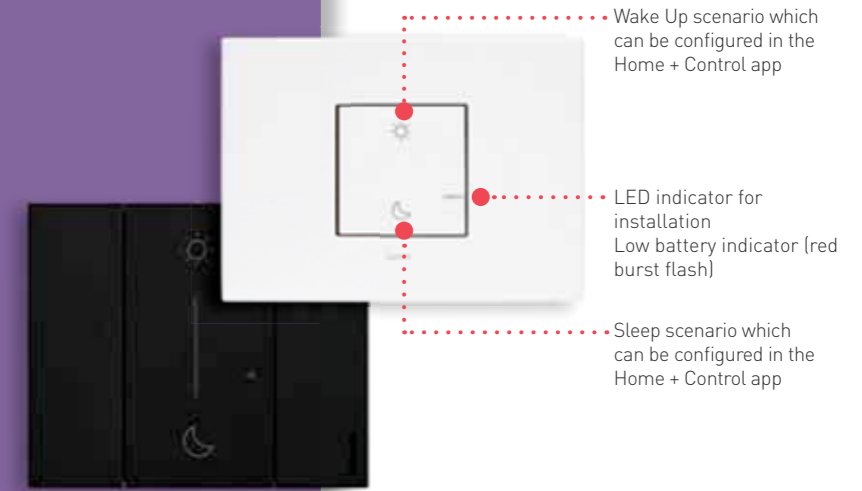

*dependent on daily usage.

CREATE A TWO-WAY SWITCH FOR NEW OR RETROFIT INSTALLATIONS

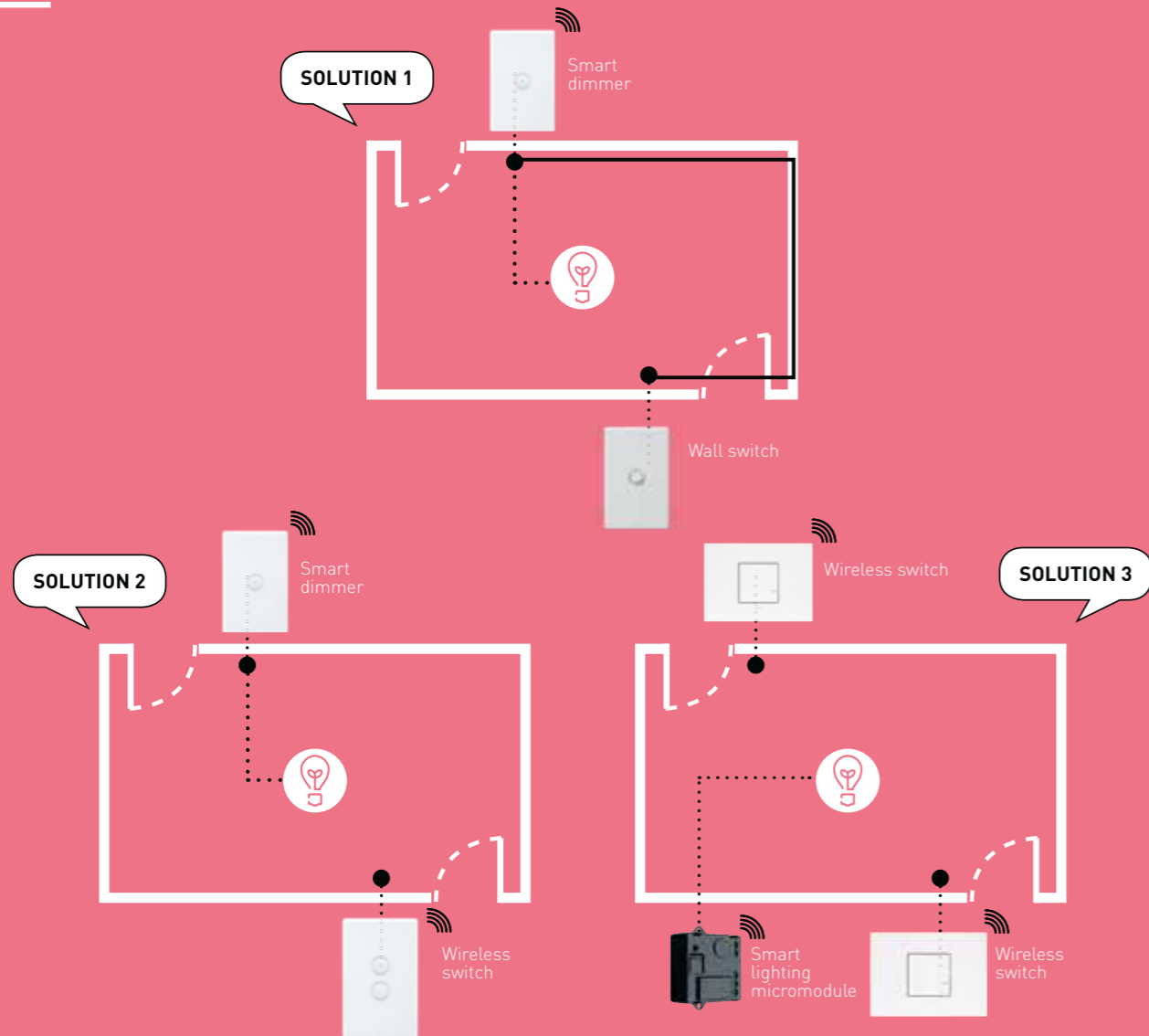

CREATE SEVERAL CONNECTED CONTROL POINTS

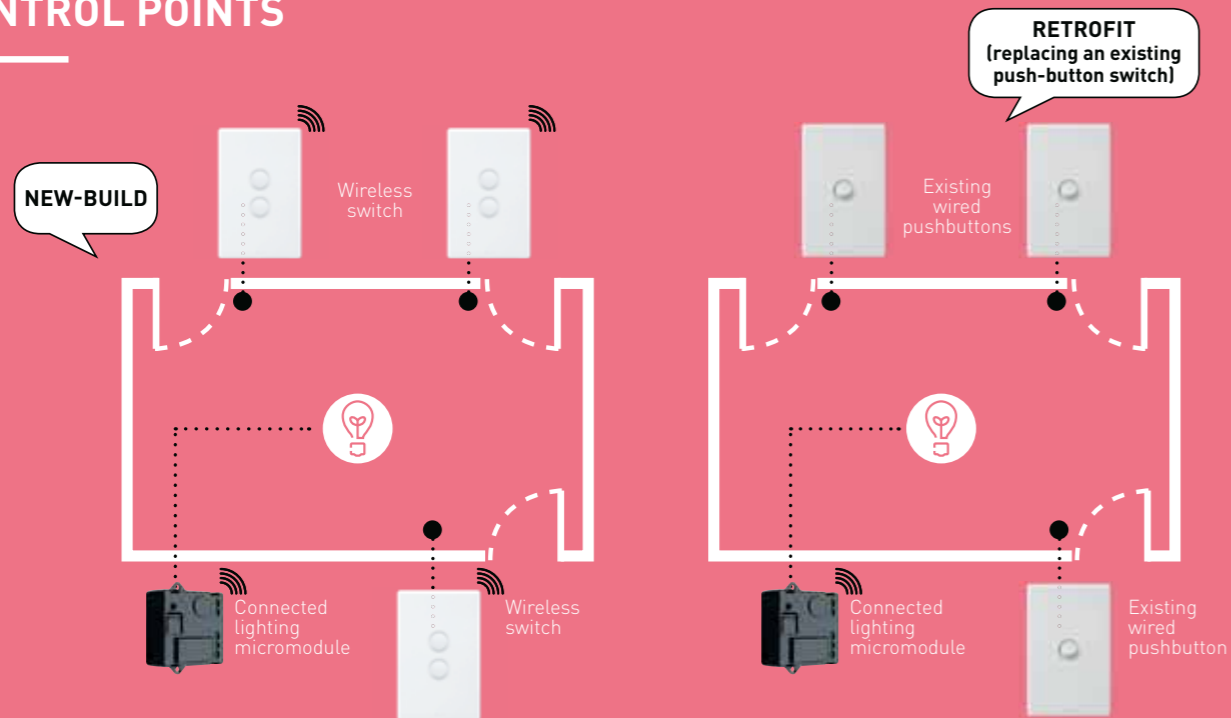

CREATE A SWITCHED POWER OUTLET FOR NEW OR RETROFIT INSTALLATION

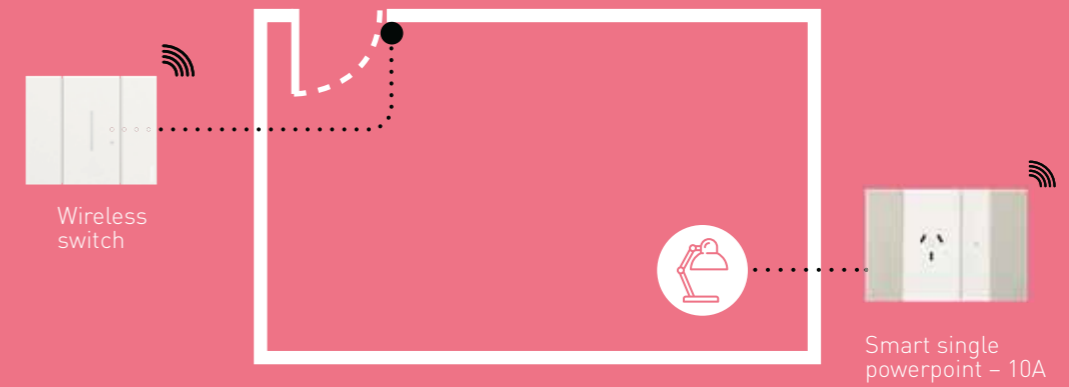

CENTRALISE SHUTTER/BLIND CONTROL

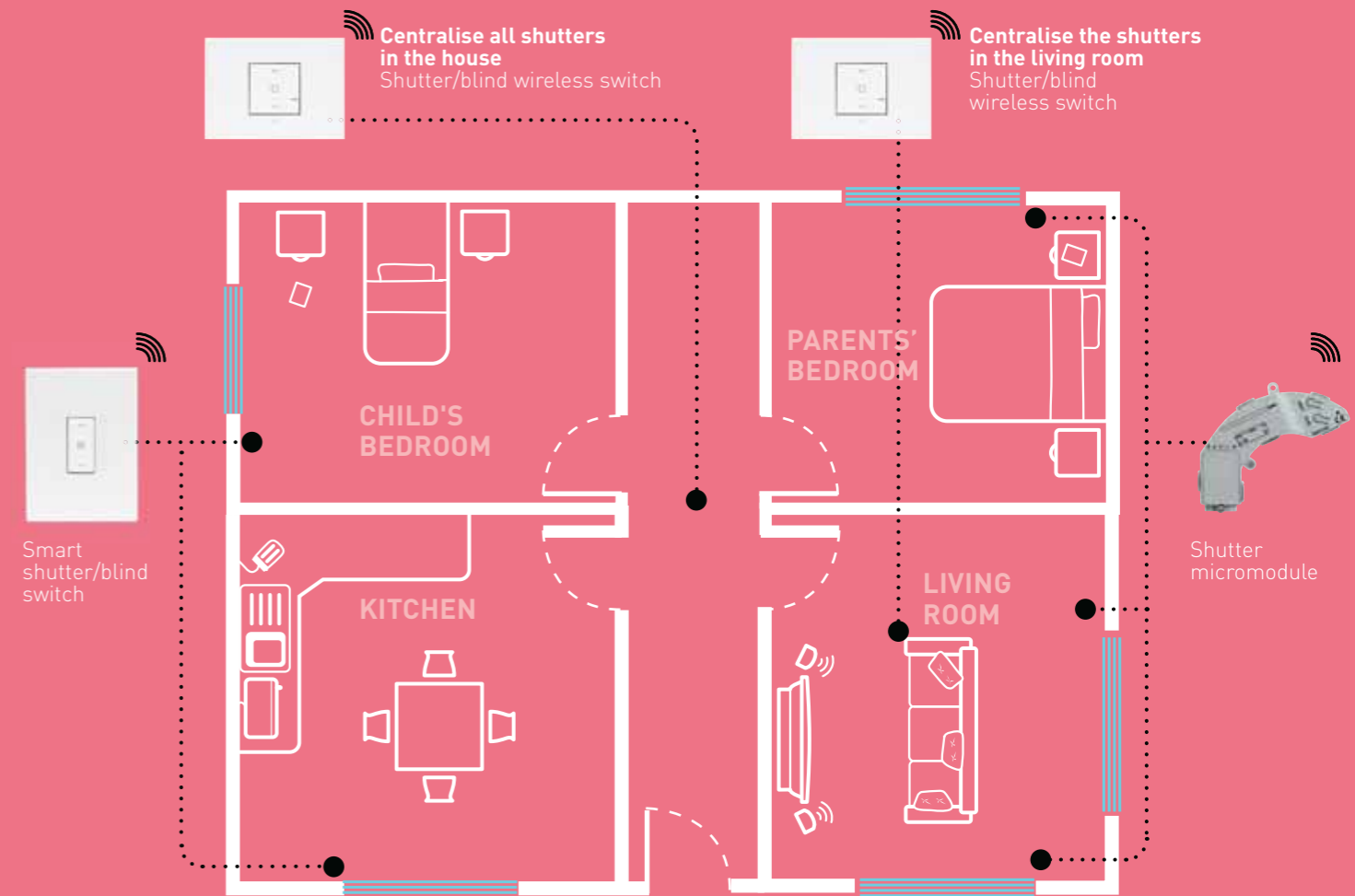

EXAMPLE SCENARIOS



“LEAVE” SCENARIO

Wireless master switch located by the entrance door. Pressing the **bottom button** activates the scenario, which can be customised to suit users' needs in the Home + Control app.



- Switches off all ceiling and wall lights
- Switches off all lamps and standard lamps
- Closes the shutters in the living room

“ARRIVE” SCENARIO

Wireless master switch located by the entrance door. Pressing the **top button** activates the scenario, which can be customised to suit users' needs in the Home + Control app.



- Switches on the lights in the corridor
- Switches on the lights and standard lamp in the living room

Below are some examples of scenarios which can be created in the Home + Control app and activated with a single touch. The installed wired products control lights, lamps, electrical appliances and shutters/blinds.

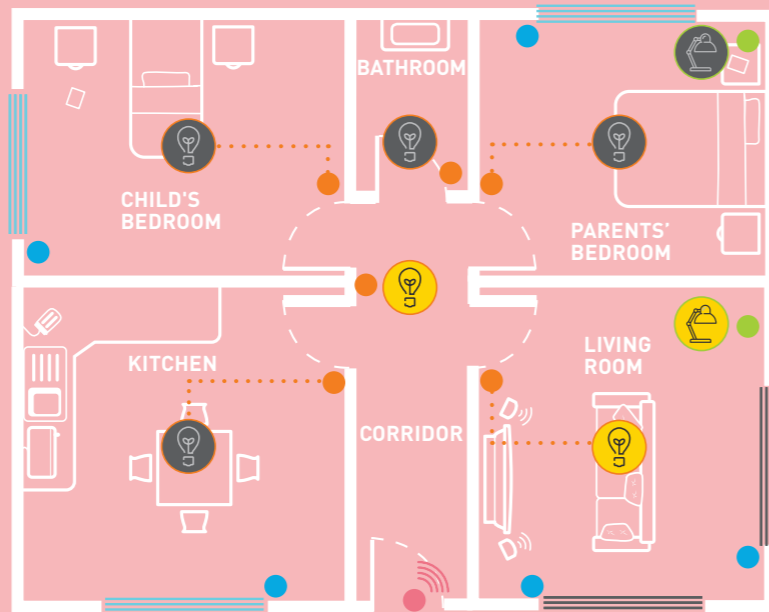
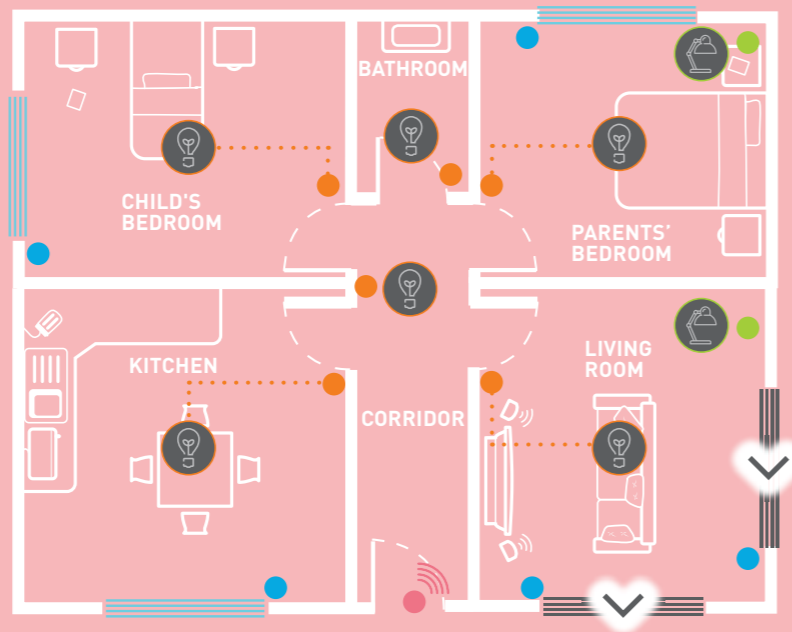

“SLEEP” SCENARIO

Night/Day wireless switch located in the parents' bedroom. Pressing the **bottom button** activates the scenario, which can be customised to suit users' needs in the Home + Control app.



- Switches off all ceiling and wall lights
- Switches off all lamps and standard lamps
- Switches on the lights in the parents' bedroom
- Closes all the shutters

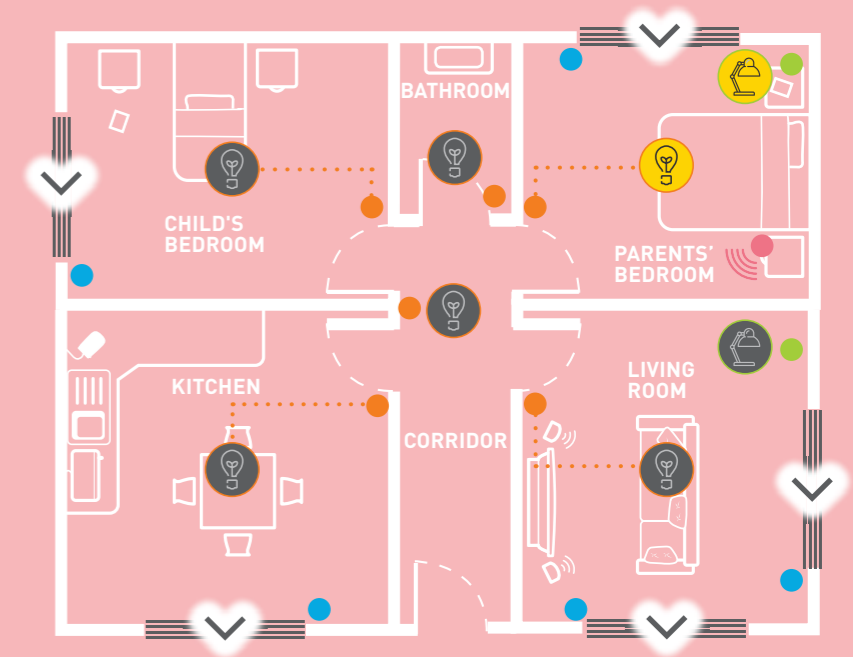

“WAKE UP” SCENARIO

Night/Day wireless switch located in the parents' bedroom. Pressing the **top button** activates the scenario, which can be customised to suit users' needs in the Home + Control app.



- Switches on the lights in the kitchen and bathroom
- Switches on the standard lamp in the living room
- Opens the shutters in the bedrooms

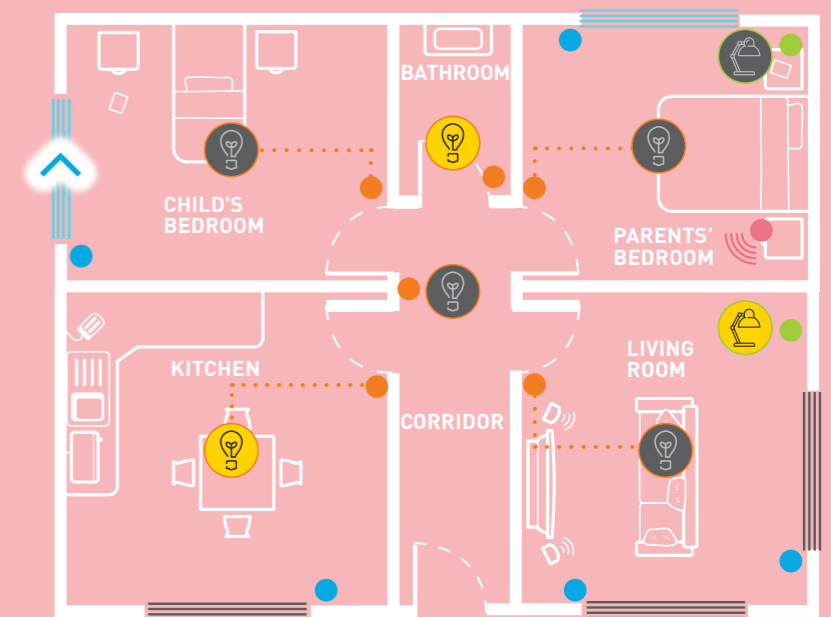

WIRING DIAGRAMS

GATEWAY
240V a.c.

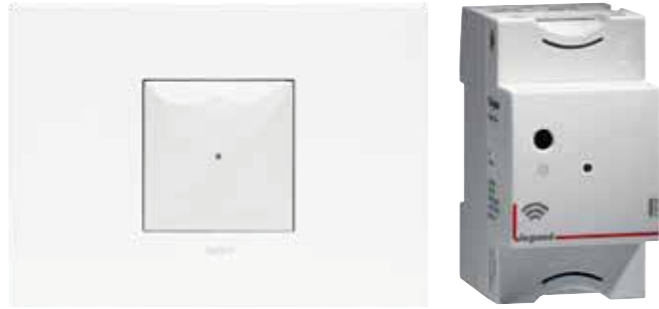

The gateway must be installed close to the router where it can pick up a good Wi-Fi signal.

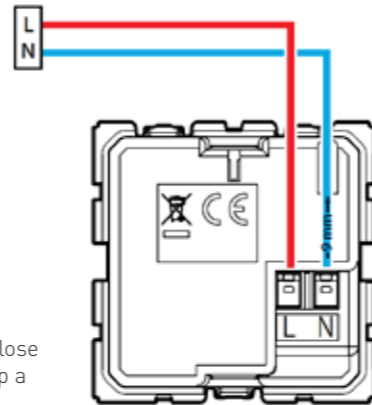

SMART SINGLE POWERPOINT
10A 240V a.c. 2400W max

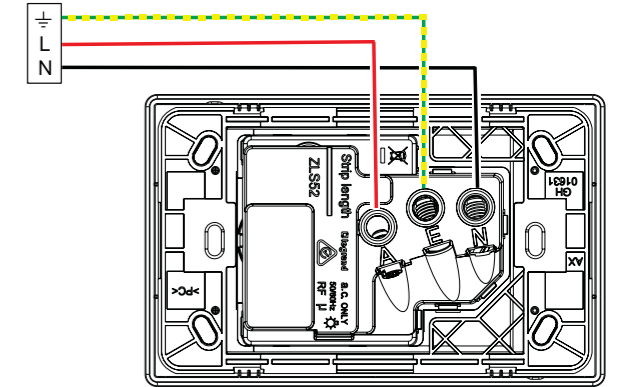

SMART LIGHT SWITCH
100W (or 10 lamps) for LEDs, with neutral

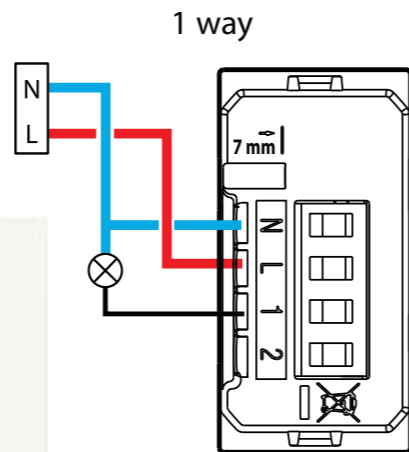

SMART SHUTTER/BLIND SWITCH
1 x 500VA - For wired shutter motor with electronic or mechanical end stop

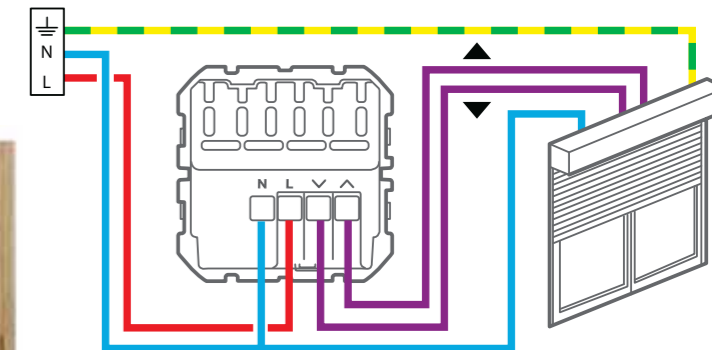

SMART DIMMER SWITCH
150W (or 10 lamps) for LEDs, with Neutral

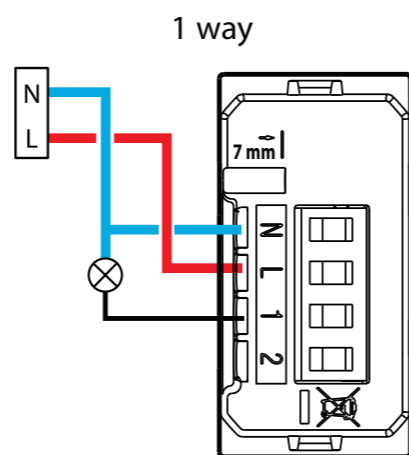

SMART LIGHTING MICROMODULE
240V a.c. - 100W for LEDs - All loads

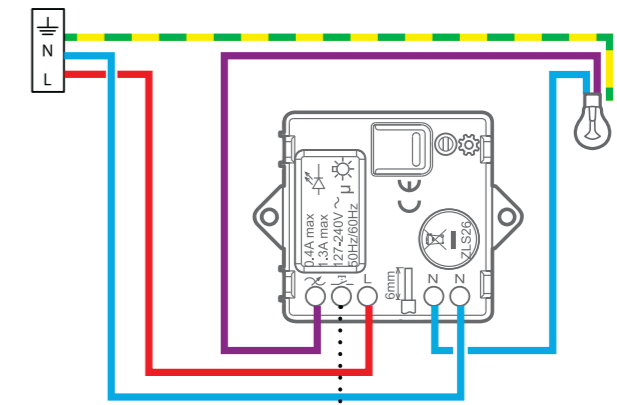
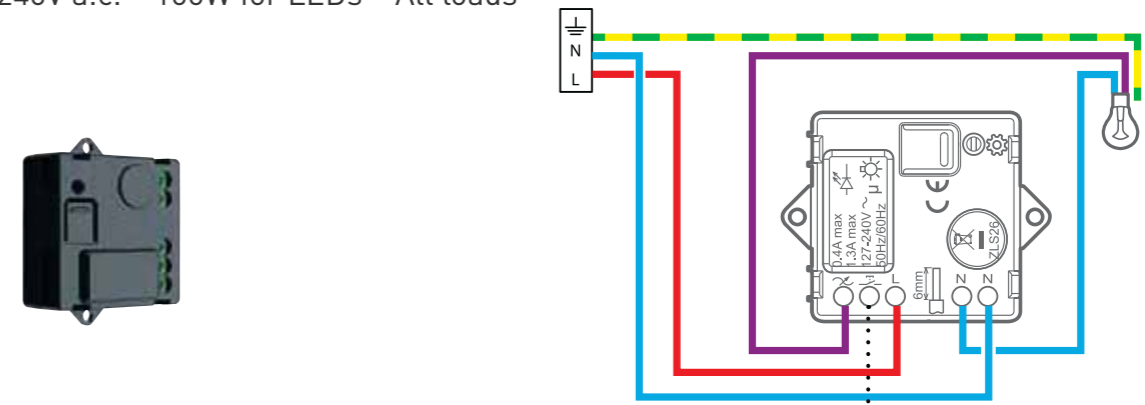

Push-buttons (up to 5)

STARTING SETUP AND PAIRING

CREATE THE NETWORK*

1 After installing and connecting up the wired products, **turn the power back on**. The LEDs on the products **light up with a steady red light**.

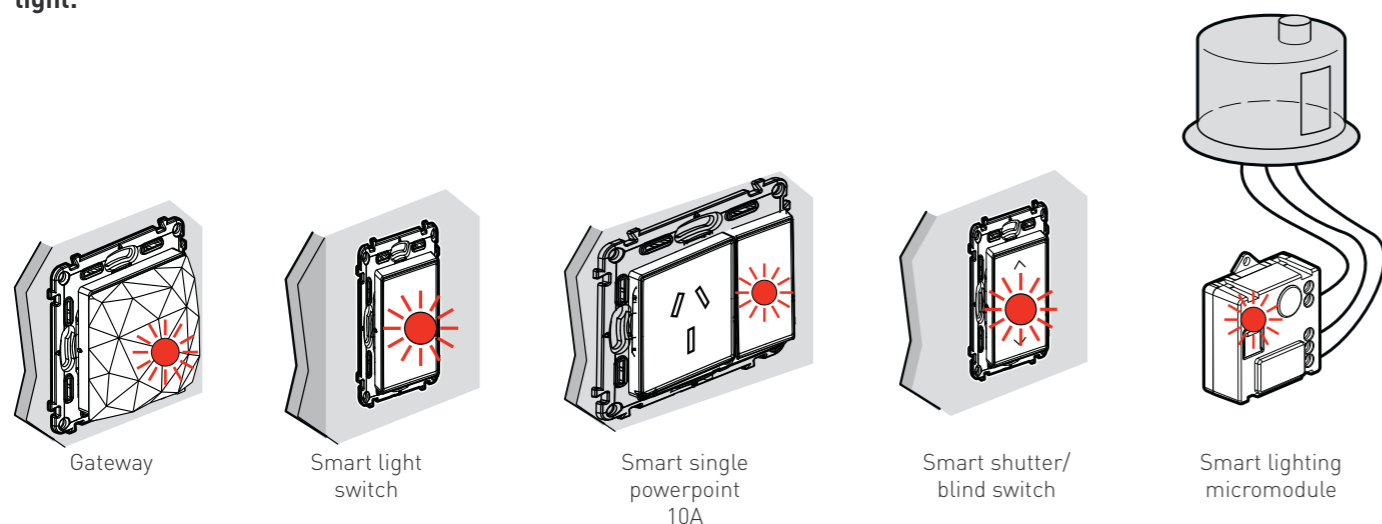

2 Remove the protective tab from the battery to supply power to the **Wireless master switch**.

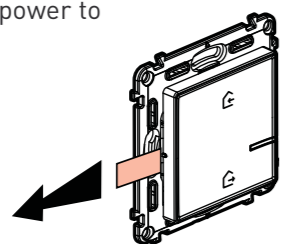

3 Press on one of the buttons on the **Wireless master switch** in order to activate it. Its LED **flashes green then goes off**. The LED on the **Gateway power outlet** also goes off.

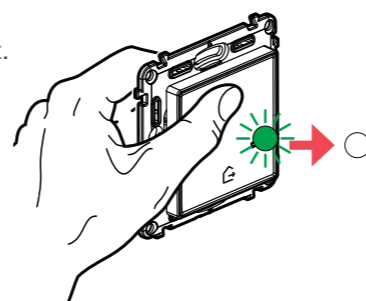

4 1. Move the **Wireless master switch** close to the **Gateway** and **hold the centre** of the switch until its LED briefly lights up green.
2. **Release hold**. The LED goes off.
3. The gateway power outlet LED changes to a steady green light.

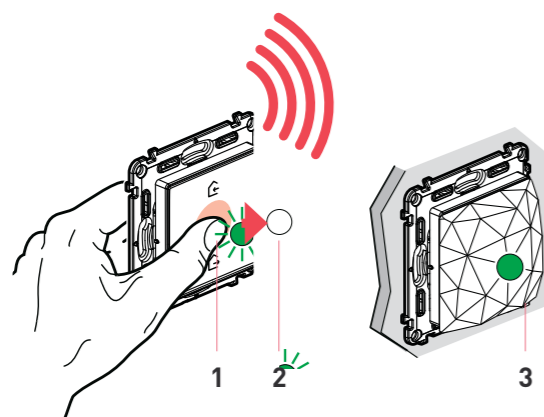

One after another, the LEDs on the other wired products change to a **steady green light**.

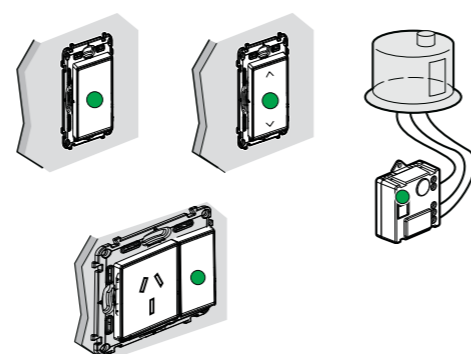

The network is created.

PAIR WIRELESS SWITCHES

1 After creating the network, you can pair wireless switches to control the connected switches and powerpoints. **Remove the protection tab** from the wireless switch you wish to pair, **then go to steps 2, 3 and 4**. Repeat the same operation with each switch, one after another.

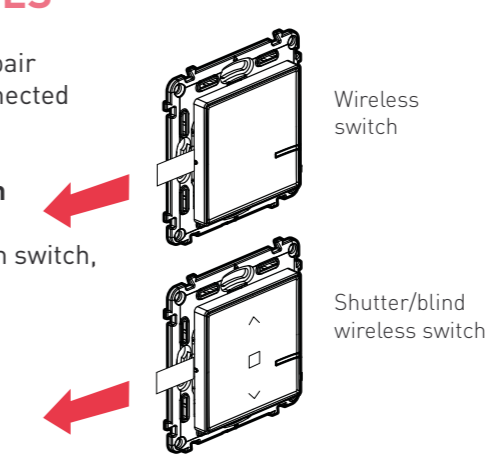

2 Press briefly at the top or bottom of the switch

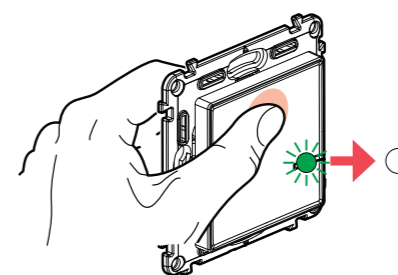

3 Keep your finger pressed on the top or bottom of the wireless switch, then **tap 3 times** on the product you wish to control.

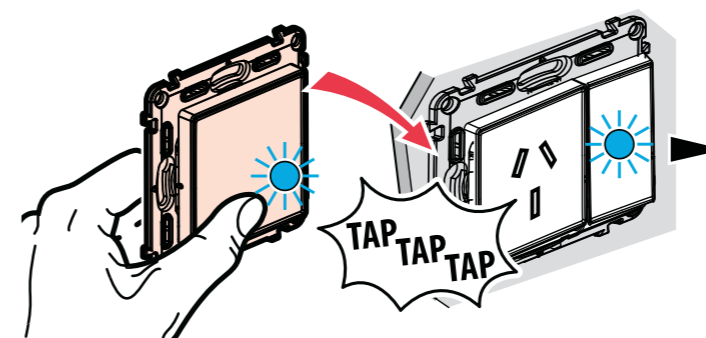

4 1. The LEDs on both products **flash quickly** (blue) then light up **briefly** (steady blue).
2. The LED on the wireless switch **goes off**, the one on the wired product **reverts to green**.

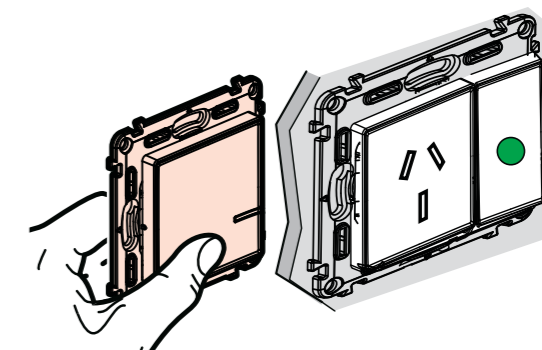

They have been paired successfully. Repeat the same operation with each wireless switch, one after another. The association wireless switch-smart wall device can also be done in the app, once the smart home configuration is completed. (see next steps in page below)

> The association between wireless switches and smart wired products can also be done at a later stage, via the Home+Control app (Settings/Add product)

IMPORTANT: Once installation is completed, leave the starter kit user guide and product manuals with your customer. The user guide contains a unique code to configure the Apple HomeKit app.

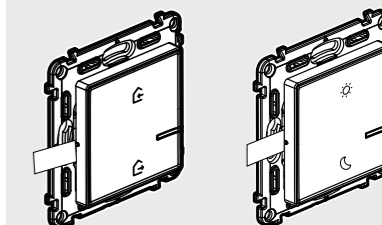

The **Wireless master switch** and **Night/Day wireless switches** are paired via the Home + Control app. For more information, please visit legrand.com or use the links below.

Wireless master switch:
<https://faq.homecontrol.eliotbylegrand.com/question/829>

Night/day wireless switch:
<https://faq.homecontrol.eliotbylegrand.com/question/828>

SETUP HOME+CONTROL APP

1 DOWNLOAD THE HOME + CONTROL APP



FREE DOWNLOAD



1. Go to App store or Google Play store.



2. Search "Legrand Home+Control".



3. Download the app.

2 CREATE AN ACCOUNT



1. Launch the Home+Control app.



2. Click on "Sign up" at the bottom of the screen.

Note: If you already own a Netatmo camera or weather station, or a Bticino Classe 100 Wi-Fi intercom, click on "Log in". Enter the same credentials as used in the app for those products.



3. Enter your Email address.



4. Choose a password meeting all criteria listed. Once logged in, press "Start".

3 SETUP

WHICH GATEWAY IS INSTALLED IN YOUR HOME?

The Gateway with Home/away switch is installed on a wall plate, generally in a central place not far from your internet modem.

The Gateway module is installed inside your electrical load centre or distribution board.



Gateway with Home/Away master switch

OR



Gateway module

Excel Life Smart example shown here. Also applies to Arteor and Living Now with Netatmo



1. Select "Legrand" (if you have Excel life Smart or Arteor with Netatmo) or "Bticino" (if you have Living Now with Netatmo) then the type of Gateway installed.

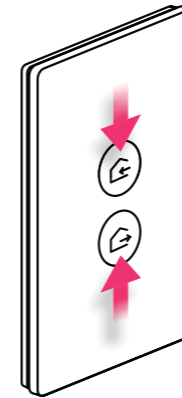

2.a

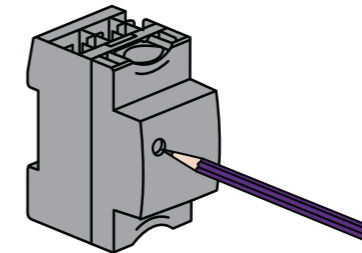

2.b

2. If you have a Gateway with Home/Away master switch: Press and hold the 2 buttons of the remote control (the one with the 2 house icons) until it flashes green then release immediately. See 2.a.

If you have the Gateway module: Use a pen/small screwdriver to press and hold the front button (recessed black spot) until the front indicator flashes green then release immediately. See 2.b.



3. Repeat Step 2 again.



4. Choose a name for your smart home. The app will start pairing your Gateway to your Wi-Fi network. Confirm when prompted.

SETUP HOME+CONTROL APP

3 SETUP (continued)



5. Use your camera to scan the **Homekit 8-digit code**

If you have a Wall Gateway: It is at the back of the remote control.
If you have a Gateway module: It is at the front of the Gateway module.



6. Wait for setup to be completed and firmware updates to be downloaded. This can take up to 5-10mins. Click **"Next"**.



7. Click **"Start"** and go to one of the rooms where your first smart product is located.



8. Select the type of room you are in and click **"Validate"**.

3 SETUP (continued)



13. When all rooms and smart products are allocated, press **"Finish"**. Review your full installation and click **"Finish"**.



14. You can now control your lights and electrical appliances in the main menu. Select the bulb next to the room name to switch ON/OFF all smart products in this room, or select the room name to see each smart product in this room and operate them independently.

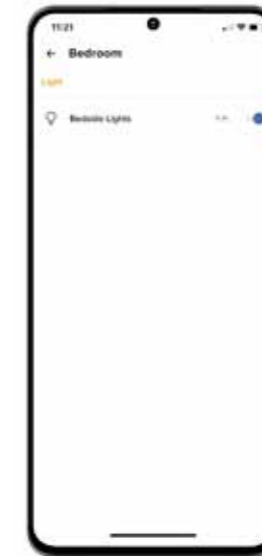

TIP: Scenarios and schedules can be operated by selecting the blue circle at the bottom of the screen. They can be customised in the **"Settings menu"**.



9. **Press** the smart products you want to configure. They will then show up in the app. Click on the product frame to see the details.



10. Rename the products by clicking on the pen symbol.



11. Click **"Done"**, once all the products in this room have been detected and renamed.

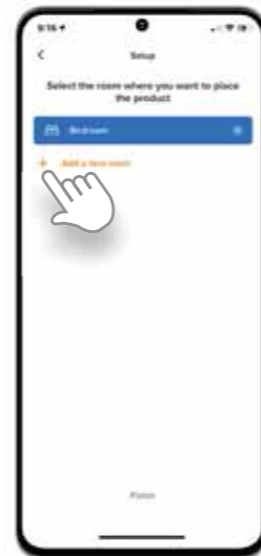

12. Click **"Add a new room"** and move to the next room where you have smart products installed. Repeat steps 8 to 11.

4 SHARE YOUR INSTALLATION WITH LOVED ONES AND OTHERS



1. Click on **"Settings"**.

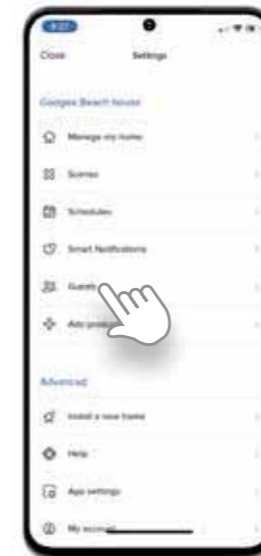

2. Select **"Guests"**.



3. Select the person you want to invite and the digital method to send the invitation. (Email, text message, social chat messages, etc.)

MUST BE ORDERED FOR ANY CONNECTED INSTALLATION

STEP 1: Gateway or Starter kit



412181 EWNSKITWE

Used to control your home remotely (lighting and electrical appliances) using a smartphone via the Home + Control App and/or voice control (via a voice assistant). Must be ordered for any connected installation. The individual connected products can be added to the gateway or starter kit. 2.4GHz Wi-Fi connection required.

Pack	Cat No.	Gateway
1	412181	<p>Used to create a connected installation. - 1 Gateway 240V a.c. Wi-Fi 2.4GHz 802.11 b/g/n Zigbee 2.4GHz to 2.4835GHz. DIN rail mounting. 2 modules DIN.</p>
		Starter kit
		<p>Used to create a connected installation Includes: - 1 Gateway 240V a.c. Wi-Fi 2.4GHz 802.11 b/g/n Zigbee 2.4GHz to 2.4835GHz. Supplied with support frame, grid & plate. - 1 Wireless master switch with preset scenarios which can be customised in the Home + Control App. Supplied with CR2032 3V battery for power supply and 4 removable stickers for wall installation. LED function for low battery indication. Supplied with support frame and coverplate. Zigbee 2.4GHz to 2.4835GHz</p>
1	EWNSKITWE	White
1	EWNSKITMW	Matt White
1	EWNSKITMB	Matt Black

STEP 2: Connected products



EWN770/1WE EWN770/3MW EWNDIM1MW EWNDIM2MB EWN787MW

Used to complete your connected installation, requires prior installation of a gateway or starter kit.

Pack	Cat No.	Smart devices - Wired (240V a.c.)
		<p>240V a.c. 3 wire Compatible with most traditional and LED lighting loads Zigbee 2.4GHz to 2.4835GHz Horizontal or Vertical orientation</p>
		Smart switch
		Max. load 100W
1	EWN770/1WE	○ White - 1 gang
1	EWN770/1MW	○ Matt White - 1 gang
1	EWN770/1MB	● Matt Black - 1 gang
1	EWN770/2WE	○ White - 2 gang
1	EWN770/2MW	○ Matt White - 2 gang
1	EWN770/2MB	● Matt Black - 2 gang
1	EWN770/3WE	○ White - 3 gang
1	EWN770/3MW	○ Matt White - 3 gang
1	EWN770/3MB	● Matt Black - 3 gang
		Smart dimmer
		Max. load 150W Dimmer mode and LED locator can be activated in the Home + Control app.
1	EWNDIM1WE	○ White - 1 gang
1	EWNDIM1MW	○ Matt White - 1 gang
1	EWNDIM1MB	● Matt Black - 1 gang
1	EWNDIM2WE	○ White - 2 gang
1	EWNDIM2MW	○ Matt White - 2 gang
1	EWNDIM2MB	● Matt Black - 2 gang
1	EWNDIM3WE	○ White - 3 gang
1	EWNDIM3MW	○ Matt White - 3 gang
1	EWNDIM3MB	● Matt Black - 3 gang
		Smart single powerpoint
		Used to control electrical appliances remotely Can be paired with one or more wireless switch to create a controlled socket 10A 240V a.c. Measures instantaneous power and monitors daily and monthly consumption, plus sends configurable notifications (fault, consumption, etc) Zigbee 2.4GHz to 2.4835GHz
1	EWN787WE	○ White
1	EWN787MW	○ Matt White
1	EWN787MB	● Matt Black

Red catalogue number: new product

STEP 2: Connected products



0 648 99

EWNM770WE EWNMDIMMW EWN770/3GPLMB

Pack	Cat No.	Smart devices - Wired (240V a.c.)
		<p>ON/OFF switch 100 W LED, wired</p> <p>Compatible with all loads: - LEDs and CFL lamps: 100 W LED - Incandescent and halogen lamps: 300 W - ELV halogen and CFL lamps with separate ballast: 250 VA</p>
1	5 742 43	
		<p>Switch with dimmer option, 150 W LED, wired</p> <p>For local or remote ON/OFF / dimming control of lighting</p> <p>Compatible with all loads: - dimmable LEDs and CFL lamps: 150 W LED - Incandescent and halogen lamps: 150 W - ELV halogen and CFL lamps with separate ballast: 150 VA</p>
1	0 648 99	
		<p>Connected curtain/roller blind micromodule</p> <p>For local and remote control of a 230 V~ roller blind (raise/lower/stop functions and level management) Compatible with roller blinds with mechanical or electronic stop, not compatible with radio-controlled roller blinds. Can be paired with one or more roller blind wireless switches. To be installed in the ceiling box or roller blind box to connect a new or existing roller blind.</p>
1	067697	

Red catalogue number: new product

STEP 2: Connected products



Used to complete your connected installation, requires prior installation of a Starter kit cat no. EWNSKIT series or DIN-rail gateway cat no. 412181

Used to complete your connected installation, requires prior installation of a gateway or starter kit.

Pack	Cat No.	Smart wireless switches and controls
1	EWNWSW1WE	Supplied complete with CR2032 3V battery and 4 stickers to mount on walls. Zigbee 2.4GHz to 2.4835GHz.
1	EWNWSW1MW	
1	EWNWSW1MB	
1	EWNWCWE	
1	EWNWCMW	
1	EWNWCMB	
1	067694	<p>Wireless Switch /dimmer</p> <ul style="list-style-type: none"> ○ White - 1 Gang - Stand-alone ○ Matt White - 1 Gang - Stand-alone ● Matt Black - 1 Gang - Stand-alone <p>Wireless auxiliary switch</p> <p>Allows to transform a mechanical 2-way switch into a wireless on/off switch. Small size for easy integration into the wall box. To be paired with one connected switch, micro-module, socket outlet. Supplied with CR2032 3V long-life battery for powersupply</p> <p>Motion sensor</p> <p>Allows to control up to 20 wired switches, micromodules and socket outlets. Easy pairing by tapping the wired products. Supplied with 2 x AA battery. For indoor and outdoor use. Recommended distance between 2 sensors: 6 m. Recommended installation height: 2.5 m. Time delay adjustable from 1 to 30 min. Range: 8 m. Detection angle: 140°. Sensor range adjustable from 2 m to 8 m. Light level threshold adjustable from 1 to 1000 lux</p>

Pack	Cat No.	Wireless - Master Switch
1	EWNWMSWE	○ White - Stand-alone
1	EWNWMSMW	○ Matt White - Stand-alone
1	EWNWMSMB	● Matt Black - Stand-alone
1	EWNWCMSE	○ White - Clip-in grid
1	EWNWCMSTMW	○ Matt White - Clip-in grid
1	EWNWCMSTMW	● Matt Black - Clip-in grid
1	EWNWBLIWE	○ White - Stand-alone
1	EWNWBLIMW	○ Matt White - Stand-alone
1	EWNWBLIMB	● Matt Black - Stand-alone
1	EWNWCBLIWE	○ White - Clip-in grid
1	EWNWCBLIMW	○ Matt White - Clip-in grid
1	EWNWCBLIMB	● Matt Black - Clip-in grid
1	EWN1GPLWE	○ White
1	EWN1GPLMW	○ Matt White
1	EWN1GPLMB	● Matt Black
1	EWN2GPLWE	○ White
1	EWN2GPLMW	○ Matt White
1	EWN2GPLMB	● Matt Black
1	EWN3GPLWE	○ White
1	EWN3GPLMW	○ Matt White
1	EWN3GPLMB	● Matt Black
1	EWN4GPLWE	○ White
1	EWN4GPLMW	○ Matt White
1	EWN4GPLMB	● Matt Black
1	EWN5GPLWE	○ White
1	EWN5GPLMW	○ Matt White
1	EWN5GPLMB	● Matt Black
1	EWN6GPLWE	○ White
1	EWN6GPLMW	○ Matt White
1	EWN6GPLMB	● Matt Black

Red catalogue number: new product

Must be ordered for any connected installation

STEP 1: Starter kit for a connected home

STEP 2: Connected extension kit



Used to control your home remotely (lighting and electrical appliances) using a smartphone via the Home + Control App and/or voice control (via a voice assistant). Must be ordered for any connected installation. The connected extension kit or individual connected products can be added to the starter kit. 2.4 GHz Wi-Fi connection required.



Used to complete your connected installation, requires prior installation of a starter or basic kit. Connected products can be added to the extension kit.

Pack	Cat.Nos	Starter kit
1	AWNSKITWE	Used to create a connected installation. Includes: - 1 Gateway 230/240V a.c., Wi-Fi 2.4GHz 802.11 b/g/n Zigbee 2.4GHz to 2.4835GHz. Supplied with support frame, coverplate and paint cover. - 1 Vertical Smart switch 1 gang 230/240V a.c. 3 wire min. load 5W Max. load 100W. Compatible with most traditional and LED Lighting loads. Zigbee 2.4GHz to 2.4835GHz. Supplied with load stabilising capacitor, support frame, coverplate and paint cover. - 1 Smart Single Powerpoint (protected against overloads) 230/240V a.c. 10A. Compatible with any electrical appliance or large Household appliance. Measures instantaneous Power and monitors daily and monthly consumption, Plus sends configurable notifications (fault, consumption, etc). Supplied with support frame, coverplate and paint cover. Zigbee 2.4GHz to 2.4835GHz. - 1 Wireless master switch with preset scenarios which can be customised in the Home + Control App. Supplied with CR2032 3V battery for power supply and 4 removable stickers for fixing the control on any walls. LED function for low battery indication. Supplied with support frame and coverplate. Zigbee 2.4GHz to 2.4835GHz
1	AWNSKITMGN	○ White
1	AWNSKITALU	● Magnesium
1	AWNSKITCHP	○ Aluminium
		● Champagne

Pack	Cat.Nos	Extension Kit
1	AWNEKITWE	Used to create a wireless two-way switch and remotely control your electrical appliances. Includes: - 1 Smart Single Powerpoint 230/240V a.c. 10A (Protected against overloads). Compatible with any electrical appliance or large household appliance. Measures instantaneous power and monitors daily and monthly consumption, plus sends configurable notifications (fault, consumptions, etc). Zigbee 2.4GHz to 2.4835GHz. Supplied with support frame, coverplate and paint cover. - 1 wireless switch. Supplied with CR2032 3V battery for power supply and 4 removable stickers for fixing the control on any walls. Zigbee 2.4GHz to 2.4835GHz. - 1 Vertical Smart Dimmer Switch 1 Gang 230/240V a.c. 3 wire Max. load 150W Compatible with most traditional and LED lighting loads. Zigbee 2.4GHz to 2.4835GHz. Dimmer mode can be activated in the Home + Control app. Locator LED light at the front can be activated in the Home + Control app. Supplied with support frame, coverplate and paint cover
1	AWNEKITMGN	○ White
1	AWNEKITALU	● Magnesium
1	AWNEKITCHP	○ Aluminium
		● Champagne

Red catalogue number: new product

STEP 2: Connected products



Used to complete your connected installation, requires prior installation of a Starter kit for connected installation

Pack	Cat.Nos	Smart Light Switch
1	AWNVS1WE	230/240V a.c. 3 wire Min. load 5W Max. load 100W Compatible with most traditional and LED Lighting loads Zigbee 2.4GHz to 2.4835GHz Supplied with support frame, coverplate and paint cover Vertical - 1 Gang ○ White ● Magnesium ● Aluminium ● Champagne
1	AWNVS1MGN	
1	AWNVS1ALU	
1	AWNVS1CHP	
1	AWNVS2WE	230/240V a.c. 3 wire Min. load 5W Max. load 100W Compatible with most traditional and LED Lighting loads Zigbee 2.4GHz to 2.4835GHz Supplied with support frame, coverplate and paint cover Vertical - 2 Gang ○ White ● Magnesium ● Aluminium ● Champagne
1	AWNVS2MGN	
1	AWNVS2ALU	
1	AWNVS2CHP	
1	AWNHS1WE	230/240V a.c. 3 wire Min. load 5W Max. load 100W Compatible with most traditional and LED Lighting loads Zigbee 2.4GHz to 2.4835GHz Supplied with support frame, coverplate and paint cover Horizontal - 1 Gang ○ White ● Magnesium ● Aluminium ● Champagne
1	AWNHS1MGN	
1	AWNHS1ALU	
1	AWNHS1CHP	
1	AWNHS2WE	230/240V a.c. 3 wire Min. load 5W Max. load 100W Compatible with most traditional and LED Lighting loads Zigbee 2.4GHz to 2.4835GHz Supplied with support frame, coverplate and paint cover Horizontal - 2 Gang ○ White ● Magnesium ● Aluminium ● Champagne
1	AWNHS2MGN	
1	AWNHS2ALU	
1	AWNHS2CHP	
1	AWNHS3WE	230/240V a.c. 3 wire Min. load 5W Max. load 100W Compatible with most traditional and LED Lighting loads Zigbee 2.4GHz to 2.4835GHz Supplied with support frame, coverplate and paint cover Horizontal - 3 Gang ○ White ● Magnesium ● Aluminium ● Champagne
1	AWNHS3MGN	
1	AWNHS3ALU	
1	AWNHS3CHP	

Red catalogue number: new product

STEP 2: Connected products



Used to complete your connected installation, requires prior installation of a Starter or Basic kit

Pack	Cat.Nos	Smart Single Powerpoint	Pack	Cat.Nos	Connected roller shutter switch
1	AWNHGPOWE	Used to control electrical appliances remotely Can be paired with one or more wireless switch to create a controlled socket 10A 230/240V a.c. Compatible with any electrical appliance or large household appliance Measures instantaneous power and monitors daily and monthly consumption, plus sends configurable notifications (fault, consumption, etc) Supplied with support frame, coverplate and paint cover Zigbee 2.4GHz to 2.4835GHz ○ White ● Magnesium ● Aluminium ● Champagne	1	AWNVBLIWE	For local and remote control of a 230/240V a.c. shutter/blind (raise/lower/stop functions, compatible with shutter/blind with mechanical and electronic stop, not compatible with radio-controlled shutter/blind) Can be paired with one or more shutter/blind wireless switches. Can be installed in place of an existing shutter/blind switch Supplied with support frame, coverplate and paint cover Zigbee 2.4GHz to 2.4835GHz ○ White ● Magnesium ● Aluminium ● Champagne
1	AWNHGPOMGN		1	AWNVBLIMGN	
1	AWNHGPOALU		1	AWNVBLIALU	
1	AWNHGPOCHP		1	AWNVBLIHP	

Red catalogue number: new product

Arteor WITH Netatmo

Connected products (continued)

STEP 2: Connected products

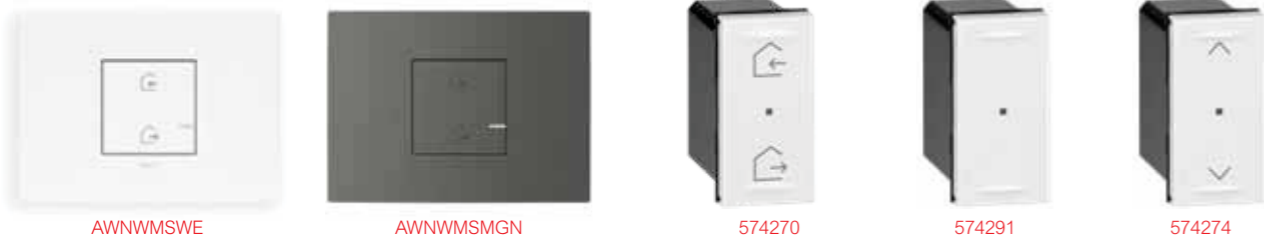

Used to complete your connected installation, require prior installation of a starter kit for connected installation

Pack	Cat.Nos	Wireless master switch	Pack	Cat.Nos	Wireless Switch
1	AWNWSWE	Used to add an extra Wireless master switch in a connected installation with multiple entrances Works in the same way as the Wireless master switch included in the starter kit or basic kit Home/Away scenarios can be customised in the Home + Control App Supplied with CR2032 3 V battery for power supply LED function for low battery indication Zigbee 2.4GHz to 2.4835GHz	1	AWNWSW1WE	Supplied with CR2032 3V battery. Zigbee 2.4GHz to 2.4835GHz
1	AWNWSMGN	Stand-alone Supplied complete with support frame, coverplate and 4 removable stickers for fixing the control unit on any walls ○ White ● Magnesium ● Aluminium ● Champagne	1	AWNWSW1MGN	Stand-alone - 1 gang Supplied complete with support frame, coverplate and 4 stickers to mount on walls ○ White ● Magnesium ● Aluminium ● Champagne
1	AWNWSALU		1	AWNWSW1ALU	
1	AWNWSCHP		1	AWNWSW1CHP	
1	574270		1	AWNWSW2WE	
1	574279	1	AWNWSW2MGN		
1	574297	1	AWNWSW2ALU		
1	574327	1	AWNWSW2CHP		
1	574270	Clip-in To be clipped into Arteor grids, alongside other Arteor / Arteor with Netatmo mechanisms ○ White ● Magnesium ● Aluminium ● Champagne	1	574291	Clip-in To be clipped into Arteor grids, alongside other Arteor / Arteor with Netatmo mechanisms ○ White ● Magnesium ● Aluminium ● Champagne
1	574279		1	574276	
1	574297		1	574275	
1	574327		1	574326	
1	AWNNDWE	Night/Day Wireless switch Used to add 2 extra scenarios to a connected installation Preset Wake up/Sleep scenarios which can be customised in the Home + Control App Supplied with CR2032 3 V battery for power supply. LED function for low battery indication Zigbee 2.4GHz to 2.4835GHz Stand-alone Supplied complete with support frame, coverplate and 4 removable stickers for fixing the control unit on any walls ○ White ● Magnesium ● Aluminium ● Champagne	1	AWNWBLIWE	Wireless shutter/blind switch Used to control one or more wired shutter/blind switches Supplied with CR2032 3 V battery for power supply LED function for low battery indication Zigbee 2.4GHz to 2.4835GHz Stand-alone Supplied complete with support frame, coverplate and 4 removable stickers for fixing the control unit on any walls ○ White ● Magnesium ● Aluminium ● Champagne
1	AWNNDMGN		1	AWNWBLIMGN	
1	AWNNDALU		1	AWNWBLIALU	
1	AWNNDCHP		1	AWNWBLIChP	
1	574273	Clip-in To be clipped into Arteor grids, alongside other Arteor / Arteor with Netatmo mechanisms ○ White ● Magnesium ● Aluminium ● Champagne	1	574274	Clip-in To be clipped into Arteor grids, alongside other Arteor / Arteor with Netatmo mechanisms ○ White ● Magnesium ● Aluminium ● Champagne
1	574290		1	574295	
1	574298		1	574299	
1	574328		1	574329	

Red catalogue number: new product

Living Now WITH Netatmo

Gateway and wireless master switch

STEP 1: Starter kit for a connected home





Cat. no.	Gateway
○ K4500C	This pack enables to create a connected installation in the home. It can be used to control lighting, roller shutters and electrical equipment plugged into connected sockets: - using your smartphone and the Home + Control app - using voice assistants - from the general control at the entrance to your home Supplied with the Home/Away wireless master switch required for the association procedure of all connected devices. Power supply 110-230 V~ - 2 modules
○ K4510C	Gateway as above. Supplied with the flush-mounted Home/Away wireless master switch 1 module required for the association procedure of all connected devices. Power supply 110-230 VA - 2 modules
○ 412181	Gateway as above for DIN switchboard. Supplied without wireless In&Out master scenario control item K4570CW. - 2.5 DIN modules.
□ KW30M2 ■ KG30M2	Cover required for the gateway 2 modules Cover for item K4500C in combination with the relative colored cover item KW40M2, KG40M2, and for item K4510C in combination with the relative colored cover item KW40, KG40.
□ KW40 ■ KG40	Covers for the gateway scenario control 1 module Cover for item K4570CW. (scenario control in the gateway item K4510C)
□ KW40M2 ■ KG40M2	2 modules Cover for item K4570CW. (scenario control in the gateway item K4500C)



Red catalogue number: new product

STEP 2: Connected products

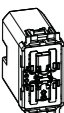

Devices to be completed with appropriate cover as indicated below.

Cat. no.	Connected switches and light relay
○ K4003C	 <p>Connected 2-ways switch. It allows to control lights locally or remotely. The connected 2-ways switch has the same installation and usability of a traditional 2-ways switch and it is compatible with all loads with max power 100 W. It is equipped with a blue LED light used always on for localisation modality or on, when the light is on for the load status modality. It can be associated with "wireless light switches". Caution: Must be connected to the neutral. Power supply 110-230 V~. - 1 module</p>
574243	 <p>Connected lighting micromodule. It allows to control lights locally or remotely. It is compatible with all loads with max power 100 W. It can be connected to one or more traditional push-button or associated with "wireless light switches". It is installed as a traditional relay in the box (behind the button) or in derivation boxes. Caution: Must be connected to the neutral. Power supply 110-230 V~.</p>

Cat. no.	Covers
□ KW01 ■ KG01	<p>1 module</p>  <p>Lightable covers for items. K4003C</p>
□ KW01M2 ■ KG01M2	<p>2 modules</p>  <p>Lightable covers for items. K4003C</p>

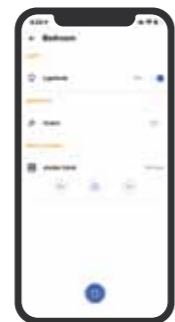

HOME + CONTROL APP

Note: For the use of the connected devices, the gateway, item **K4500C** or **412181** must be installed as part of the system. If the gateway is connected to the internet through the Wi-Fi network, it will be possible to manage the system from the home using the specific **HOME + CONTROL** App.

Three-way switching with connected two-way switch, item K4003C, installed instead of a traditional two-way switch.

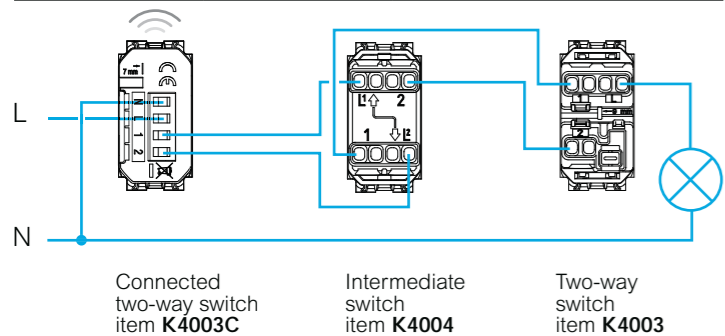

Three-point lighting control with pushbuttons and connected lighting micromodule, item 574243, installed instead of a traditional relay.

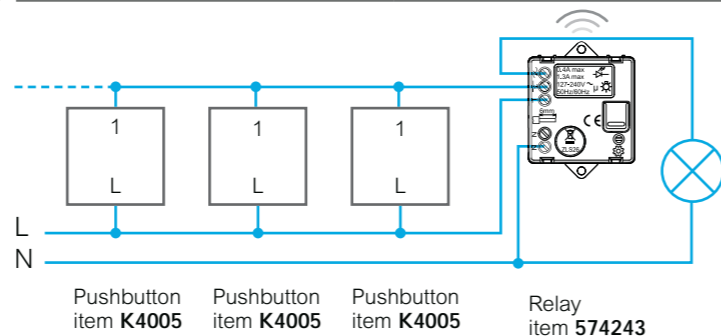



□ White colour cover ■ Black colour cover ○ Neutral item (without cover)

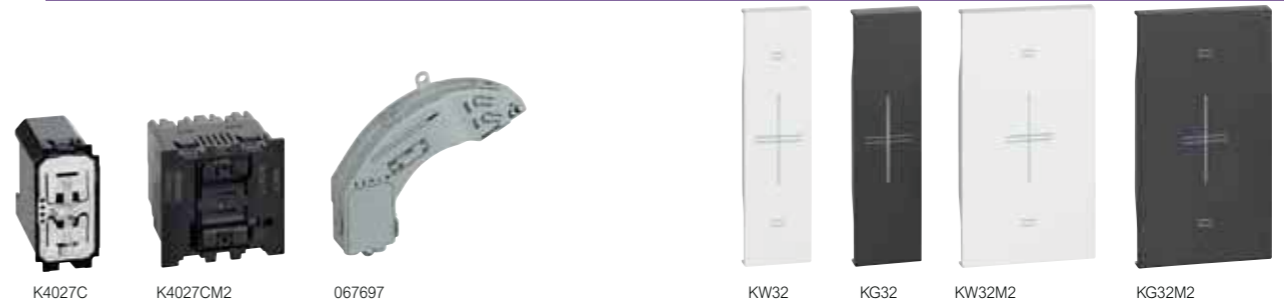

Whilst most items are stock lines some products are made to order. For delivery dates, custom prints and latest prices please contact your local Legrand customer service representative

STEP 2: Connected products

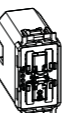

Devices to be completed with appropriate cover as indicated below.

Cat. no.	Connected devices for shutters
○ K4027C	 <p>Connected rolling shutter switch - It allows the control of a shutter locally or remotely. Compatible with all standard rolling shutter motors (with a mechanical or electromechanical stop and max power 500 VA) controlled by a wired shutter switch (switching of the same motor power supply). Not compatible with motors for radio-controlled or pulse-controlled roller shutters. It can be associated with one or more wireless commands. Caution: Must be connected to the neutral. Power supply 110-230 V~. - 1 module</p>
○ K4027CM2	 <p>As K4027C - 2 modules</p>
○ 067697	 <p>Connected micromodule for shutters. Associated to one or more shutter wireless controls, it controls a shutter locally or remotely. Compatible with all standard shutter motors (with mechanical or electronic limit switch and maximum power 500 VA), controlled by a wired shutter changeover switch (changeover with the same power supply as the motor). Not compatible with radio controlled or pulse controlled shutter motors. It can be installed in the existing shutter box with no need of masonry works. Power supply 110-230 V~.</p>

Cat. no.	Covers
□ KW32 ■ KG32	<p>1 module</p>  <p>Cover for item K4027C.</p>
□ KW32M2 ■ KG32M2	<p>2 modules</p>  <p>Cover for items K4027C and K4027CM2.</p>

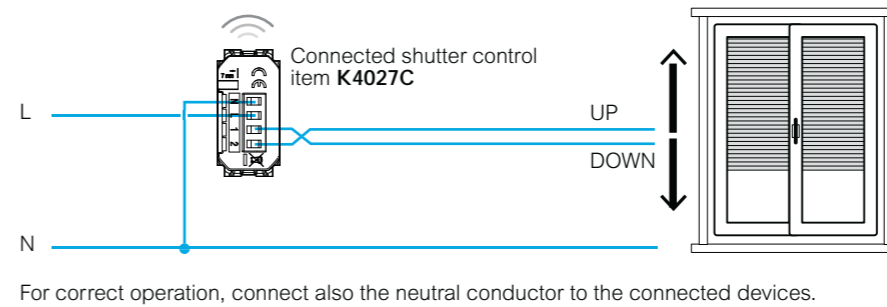

For correct operation, connect also the neutral conductor to the connected devices.

Note: For the use of the connected devices, the gateway, item **K4500C** or **412181** must be installed as part of the system.

If the gateway is connected to the internet through the Wi-Fi network, it will be possible to manage the system from the home using the specific **HOME + CONTROL** App.



HOME + CONTROL APP

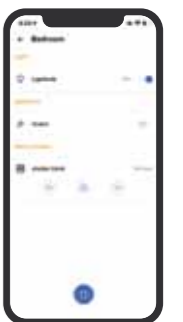

□ White colour cover ■ Black colour cover ○ Neutral item (without cover)

Whilst most items are stock lines some products are made to order. For delivery dates, custom prints and latest prices please contact your local Legrand customer service representative

STEP 2: Connected products



K4411C



KW01 KG01

Devices to be completed with appropriate cover as indicated below.

Cat. no.	Connected dimmer/switch
○ K4411C	<p>Universal dimmer</p> <p>Dimmer/switch. It allows to control lights locally or remotely, with the dimmer functionality that can be activated from the Home + Control app. It has the same installation and usability of a traditional switch and it is compatible with all loads (LED, halogen) with max power 150 W at 230 V (or 75 W at 110 V). It is equipped with a blue LED light used for localisation modality or load status modality, configurable by App. It can be connected to one or more traditional push-button or associated with "wireless light switches". Caution: Must be connected to the neutral. Power supply 110-230 V~. - 1 module.</p>

Cat. no.	Covers
□ KW01 ■ KG01	<p>1 module</p> <p>Cover for item K4411C.</p>

Note: For the use of the connected devices, the gateway, item **K4500C** or **K4510C** must be installed as part of the system.

If the gateway is connected to the internet through the Wi-Fi network, it will be possible to manage the system from the home using the specific **HOME + CONTROL** App.

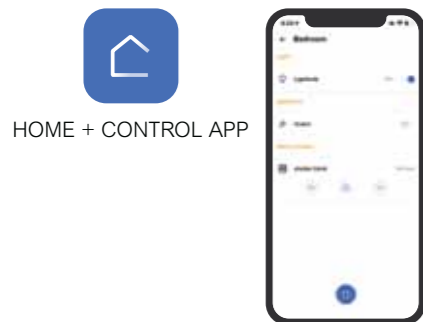

HOME + CONTROL APP

Dimmer/switch item K4411C with remote pushbuttons.

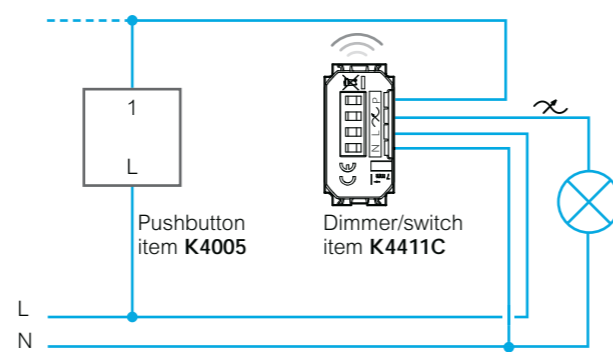

□ White colour cover

■ Black colour cover

○ Neutral item (without cover)

Whilst most items are stock lines some products are made to order. For delivery dates, custom prints and latest prices please contact your local Legrand customer service representative

STEP 2: Connected products

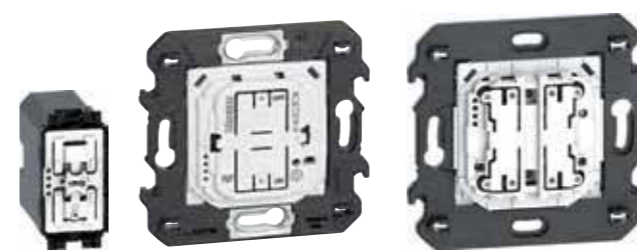

K4003CWI K4003CW K4003DCW



KW01 KW43M2 574252

Devices to be completed with appropriate cover as indicated below.

Cat. no.	Wireless controls for light
○ K4003CWI	<p>Wireless light switch. It allows the ON/OFF and dimming control of one or more connected devices for the lighting control. It can be installed in any flush-mounted box without any wiring. The battery can be replaced without removing it from the supporting frame. Integrated LED for low battery indication. Powered by battery 3V type CR2032 (supplied) with an autonomy of 8 years - 1 module</p>
○ K4003CW	<p>Wireless light switch. It allows the ON/OFF and dimming control of one or more connected devices for the lighting control. Surface installation with repositionable stickers (supplied) or onto a flush mounting box. Integrated LED for low battery indication. Powered by battery 3V type CR2032 (supplied) with an autonomy of 8 years - 2 modules</p>
○ K4003DCW	<p>Wireless light switch. It is equipped with two buttons to control two different connected devices for lights. Each single button can be associated with one or more devices. Surface installation with repositionable stickers (supplied) or onto a flush mounting box. Integrated LED for low battery indication. Powered by battery 3V type CR2032 (supplied) with an autonomy of 8 years - 2 modules</p>
○ 067694	<p>Wireless module for mechanical switch. It allows to change a 2-way switch or a traditional pushbutton into a wireless light control for ON/OFF control of one or more devices connected for light control. The small size allows the installation in the flush mounted box. CR2032 type 3V power battery with 8 year expected life supplied (as standard).</p>
○ K4027CWI	<p>Wireless controls for shutter</p> <p>Rolling shutter wireless switch - It allows the control of one or more connected rolling shutter switches. It can be installed in any flush-mounted box without any wiring. The battery can be replaced without removing it from the supporting frame. Integrated LED for low battery indication. Powered by battery 3V type CR2032 (supplied) with an autonomy of 8 years - 1 module</p>
○ K4027CW	<p>Rolling shutter wireless switch - It allows the control of one or more connected rolling shutter switches. Surface installation with repositionable stickers (supplied) or onto a flush mounting box. Integrated LED for low battery indication. Powered by battery 3V type CR2032 (supplied) with an autonomy of 8 years - 2 modules</p>

Cat. no.	Cover
□ KW01 ■ KG01	<p>1 module</p> <p>Cover for item K4003CWI</p>
□ KW33 ■ KG33	<p>Cover for item K4003CWI</p>
□ KW32 ■ KG32	<p>Cover for item K4027CWI</p>
□ KW42M2 ■ KG42M2	<p>2 modules</p> <p>Cover for item K4003CW</p>
□ KW36M2 ■ KG36M2	<p>Cover for item K4003DCW</p>
□ KW43M2 ■ KG43M2	<p>Cover for item K4027CW</p>

Cat. no.	Motion sensor wireless
○ 574252	<p>It controls one or more devices connected for light control. Infrared detection with angle of 140°. Distance of the adjustable sensor from 2 to 8 m. Switch off delay with 1 to 30 min adjustable delay time and 1 to 1000 lux brightness threshold. Test possible with a 5 sec. delay Recommended assembly height: 2.5 m. Optimum distance between 2 detectors: 6 m. For indoor and outdoor use (IP44). Supplied with 2 1.5V AA batteries for power supply.</p>

Note: For the use of the connected devices, the gateway, item **K4500C** or **412181** must be installed as part of the system. If the gateway is connected to the internet through the Wi-Fi network, it will be possible to manage the system from the home using the specific **HOME + CONTROL** App.



HOME + CONTROL APP

□ White colour cover

■ Black colour cover



○ Neutral item (without cover)

Whilst most items are stock lines some products are made to order. For delivery dates, custom prints and latest prices please contact your local Legrand customer service representative

STEP 2: Connected products



Devices to be completed with appropriate cover as indicated below.

Cat. no.	Connected devices for energy management	Cat. no.	Cover
○ K4531C	 <p>Connected socket module - wiring to a power outlet, allows to remotely control appliances and check the consumption (instantaneous, daily, monthly). It is also possible to receive notifications in case of anomalous consumption. The connected socket module is compatible with any device electric and large appliances up to 16 A 3680 W max. (protected against overloads). It is equipped with a LED light lit in blue when it is on. This option can be enabled or disabled in the "Home+Control" app. It can be associated with "wireless light switches". Power supply 110-230 V~ - 1 module</p>	<input type="checkbox"/> KW31 <input checked="" type="checkbox"/> KG31	 <p>1 module Cover for item K4531C</p>
○ 412015	 <p>Connected DIN meter. It allows to measure the energy consumption of the house electric installation (instantaneous, daily, monthly). It is also possible to receive notifications in case of exceeded the maximum power provided by your contract to avoid possible black-out. A toroid is provided to read the current. Power supply 110-230 V~ - 1 DIN module</p>		

White colour cover









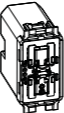

Black colour cover

Neutral item (without cover)

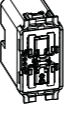
STEP 2: Connected products



Devices to be completed with appropriate cover as indicated below.

Cat. no.	Wireless Home/Away scenario controls	Cat. no.	Covers
○ K4570CWI	 <p>Home/away wireless switch wireless switch. It is equipped with 2 buttons for activating Home/away scenarios. Scenarios can be customised by the Home + Control app. It can be installed in any flush-mounted box without any wiring. The battery can be replaced without removing it from the supporting frame. Integrated LED for low battery indication. Powered by battery 3V type CR2032 (supplied) with an autonomy of 8 years - 1 module</p>	<input type="checkbox"/> KW40 <input checked="" type="checkbox"/> KG40	 <p>1 module Cover for item K4570CWI</p>
○ K4570CW	 <p>Home / Away wireless switch. It is equipped with 2 buttons for activating Home / Away scenarios. Scenarios can be customised by the Home + Control app. Surface installation with repositionable stickers (supplied) or onto a flush mounting box. Integrated LED for low battery indication. Powered by battery 3V type CR2032 (supplied) with an autonomy of 8 years - 2 modules</p>	<input type="checkbox"/> KW40M2 <input checked="" type="checkbox"/> KG40M2	 <p>2 modules Cover for item K4570CW</p>
○ K4574CWI	 <p>It is equipped with 2 buttons for activating Wake Up / Sleep scenarios. Scenarios can be customised by the Home + Control app. It can be installed in any flush-mounted box without any wiring. The battery can be replaced without removing it from the supporting frame. Integrated LED for low battery indication. Powered by battery 3V type CR2032 (supplied) with an autonomy of 8 years - 1 module</p>	<input type="checkbox"/> KW41 <input checked="" type="checkbox"/> KG41	 <p>1 module Cover for item K4574CWI</p>
○ K4574CW	 <p>It is equipped with 2 buttons for activating Wake Up / Sleep scenarios. Scenarios can be customised by the Home + Control app. Surface installation with repositionable stickers (supplied) or onto a flush mounting box. Integrated LED for low battery indication. Powered by battery 3V type CR2032 (supplied) with an autonomy of 8 years - 2 modules</p>	<input type="checkbox"/> KW41M2 <input checked="" type="checkbox"/> KG41M2	 <p>2 modules Cover for item K4574CW</p>
○ K4575CW	 <p>It's equipped with 4 buttons for activating of scenarios 1,2,3 and 4. Scenarios can be customised by the Home+ Control app. Surface installation with repositionable stickers (supplied) or onto a flushmounting box. Integrated LED for low battery indication. Powered by battery 3V type CR2032 (supplied) with an autonomy of 8 years - 2 modules.</p>	<input type="checkbox"/> KW37M2 <input checked="" type="checkbox"/> KG37M2	 <p>2 modules Cover for item K4575CW</p>

White colour cover

Black colour cover

Neutral item (without cover)



Legrand Australia

Building 4, Nexus Industry Park
43-47 Lyn Parade
Prestons NSW 2170
Tel.: 1300 369 777
www.legrand.com.au

Legrand New Zealand

106 - 124 Target Road
Glenfield
Auckland 0627
Tel.: 0800 476 009
www.legrand.co.nz