

XS230BLNAL2

inductive sensor XS2 M30 - L57mm - brass - Sn15mm - 12..24VDC - cable 2m

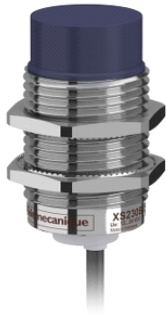

Main

Range of product	OsiSense XS
Series name	General purpose
Sensor type	Inductive proximity sensor
Sensor name	XS2
Sensor design	Cylindrical M30
Size	57 mm
Body type	Fixed
Enclosure material	Nickel plated brass
Type of output signal	Discrete
Wiring technique	3-wire
[Sn] nominal sensing distance	15 mm
Discrete output function	1 NO
Discrete output type	NPN
Electrical connection	Cable
Cable length	2 m
[Us] rated supply voltage	12...24 V DC with reverse polarity protection
Switching capacity in mA	<= 200 mA with overload and short-circuit protection
IP degree of protection	IP67 conforming to IEC 60529

Complementary

ISO thread	M30 x 1.5
Detection face	Frontal
Detector flush mounting acceptance	Non flush mountable
Material	Metal
Front material	PBT
Operating zone	0...12 mm
Differential travel	1...15% of Sr
Output circuit type	DC
Cable composition	3 x 0.14 mm ²
Wire insulation material	PVC
Status LED	1 LED yellow for output state
Supply voltage limits	10...36 V DC
Switching frequency	<= 300 Hz
Voltage drop	<= 2 V at closed state
Current consumption	<= 10 mA at no-load
Delay first up	<= 15 ms
Delay response	<= 0.2 ms
Delay recovery	<= 1.4 ms
Marking	CE
Threaded length	32 mm
Height	30 mm
Length	57 mm
Product weight	0.155 kg

Environment

product certifications	CSA
------------------------	-----

The information provided in this documentation contains general descriptions and/or technical characteristics of the products contained herein. This documentation is not intended as a substitute for and is not to be used for determining suitability or reliability of these products for specific user applications. It is the duty of any such user or integrator to perform the appropriate and complete risk analysis, evaluation and testing of the products with respect to the relevant specific application or use thereof. Neither Schneider Electric Industries SAS nor any of its affiliates or subsidiaries shall be responsible or liable for misuse of the information contained herein.

UL

ambient air temperature for operation	-25...70 °C
ambient air temperature for storage	-40...85 °C
vibration resistance	25 gn amplitude = +/- 2 mm (f = 10...55 Hz) conforming to IEC 60068-2-6
shock resistance	50 gn for 11 ms conforming to IEC 60068-2-27

Offer Sustainability

Sustainable offer status	Not Green Premium product
RoHS (date code: YYWW)	Compliant - since 0903 - Schneider Electric declaration of conformity
Product environmental profile	Available
Product end of life instructions	Available

Dimensions

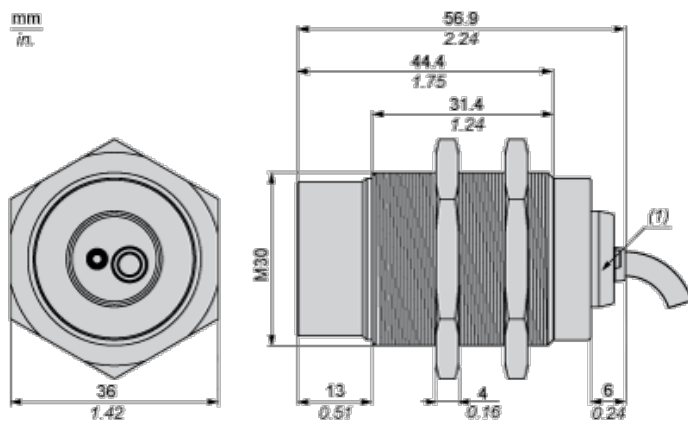

(1) LED

Minimum Mounting Distances

Side by side

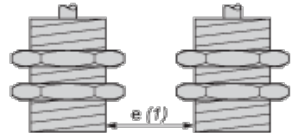

e (1) 60 mm/2.36 in.

≥

Face to face

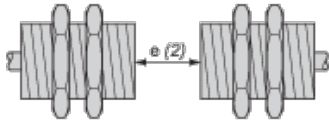

e (2) 180 mm/7.09 in.

≥

Facing a metal object

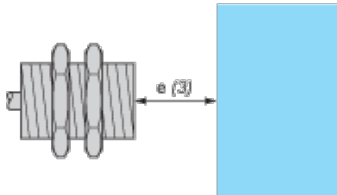

e (3) 45 mm/1.77 in.

≥

Mounted in a metal support

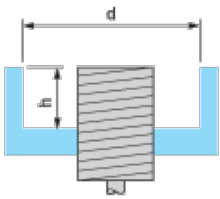

$d \geq 90 \text{ mm}/3.54 \text{ in.}$

$h \geq 30 \text{ mm}/1.18 \text{ in.}$

Wiring Schemes

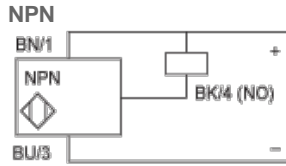

BU : Blue

BN : Brown

BK : Black

Performance Curves

Standard Steel Target : 45x45x1 mm

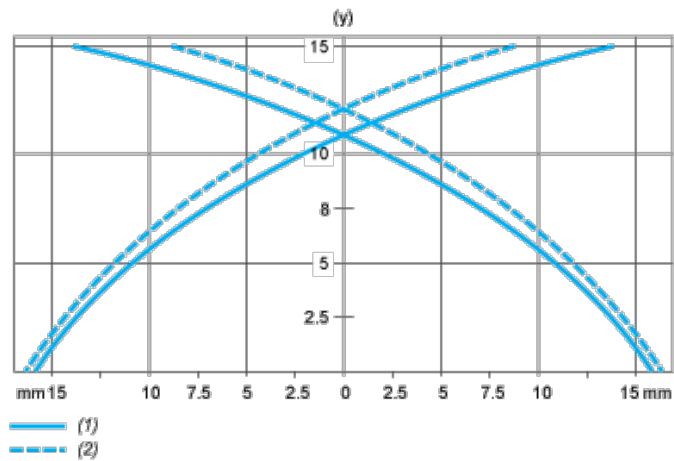

(1) Pick-up points

(2) Drop-out points (object approaching from the side)

(y) Sensing distance in mm