

Catalogue No: **CPL-48M250-G**

C/PLUS PBOARD DIN-T 48W 250A MSW 4M-864mm GREY

Power Distribution and Protection > Distribution Boards > Panelboards > CONCEPT PLUS Panelboard > Concept Plus Panelboard CPL > Grey - Mild Steel



CONCEPT PLUS Panelboard, IP42, DIN-T 48-Way 250 A NC Chassis, 250 A Isolator Main Switch, 4M-864 mm, Storm Grey (N42)

- Standard AS/NZS 61439-3
- Partial type tested busbar system
- Option - Compact 160 A or 250 A main switch
- Option - Isolator or circuit breaker main switch
- Modular sizes up to 96-Way
- Knockouts for up to 18 modules DIN equipment
- Accessory modules
- Removable gland plates
- Door fitted independent of escutcheon
- Right hand door hinging
- Semi flush door swing handle
- IP42 (option IP52)
- Chassis tee-off isolator option

Representative Photo Only
(actual product may vary based on configuration selections)

SPECIFICATIONS

| | |
|--|--------------------------------|
| Product Series | Concept Plus |
| Component Type Power Distribution & Protection | Panelboard |
| Chassis Type | Encapsulated |
| IP Rating | IP42 |
| IP rating, with door | IP42 |
| IP rating, without door | IP30 |
| Number of Poles | 48 |
| Box Size | 4 |
| Number of Modules | 4 qty |
| Height | 864 mm |
| Depth, Including Door | 200 mm, incl door |
| Depth, Door | 20 mm depth |
| MCB Type | DIN Profile |
| Main Switch Type | Isolator Main Switch |
| In, Rated Current, Main Switch | 250 A |
| Product series, chassis | NC |
| In, rated current, busbar | 250 A |
| Icw, Busbar Withstand Current, 100ms (rms) | 25 kA for 100ms |
| Segregation Form Rating | 1 |
| Material | Powder Coated Mild Steel |
| Material Thickness | 1.6 mm |
| Material, Base | Mild Steel |
| Material Thickness, Base | 1.6 mm |
| Finish, Base | Powder Coated (Polyester) base |
| Colour, Base | Storm Grey (N42) base |
| Material, door | Mild Steel |
| Material thickness, door | 1.6 mm |
| Finish, Door | Powder Coated (Polyester) door |

Catalogue No: **CPL-48M250-G**

C/PLUS PBOARD DIN-T 48W 250A MSW 4M-864mm GREY

Power Distribution and Protection > Distribution Boards > Panelboards > CONCEPT PLUS Panelboard > Concept Plus Panelboard CPL > Grey - Mild Steel



| | |
|---|---|
| Colour, Door | Storm Grey (N42) door |
| Door Handle Type | Semi flush keyed CL001 quarter turn |
| Door hinged independent escutcheon | Yes, from RH side standard |
| Escutcheon | Bright white gloss hinged RH side |
| Material, Escutcheon | Mild Steel |
| Material Thickness, Escutcheon | 1.2 mm |
| Finish, Escutcheon | Powder Coated (Polyester) escutcheon |
| Colour, Escutcheon | White escutcheon |
| Gland Plate/End Cap | Removable 1.6 mm mild steel, top/bottom |
| Spare DIN rail space (free poles) | 18 |
| Earth and Neutral bar Rating | 250 A Bar, 2 screw tunnel terminals (M8 studs top and bottom, spare 1 x 25 mm + 1 x 16 mm, 2 x 25 mm tunnel terminals and remainder 2 screw 16 mm tunnel terminals) |
| Ue, rated operational voltage, AC, 1ph, nom | 240 V AC |
| Ue, rated operational voltage, AC, 3ph, nom | 415 V AC |
| Width | 600 mm |
| Standards Compliance | AS/NZS 61439.3 |

REFERENCES

| | |
|---|---|
| IECEX Certificate | - |
| Supplier Declaration of Conformity: | - |
| Installation Guide: | - |
| User Manual: | - |
| Manufacturer Datasheet: | - |
| Manufacturer Catalogue & Product Selection: | - |

Catalogue No: **CPL-48M250-G**

C/PLUS PBOARD DIN-T 48W 250A MSW 4M-864mm GREY

Power Distribution and Protection > Distribution Boards > Panelboards > CONCEPT PLUS Panelboard > Concept Plus Panelboard CPL > Grey - Mild Steel

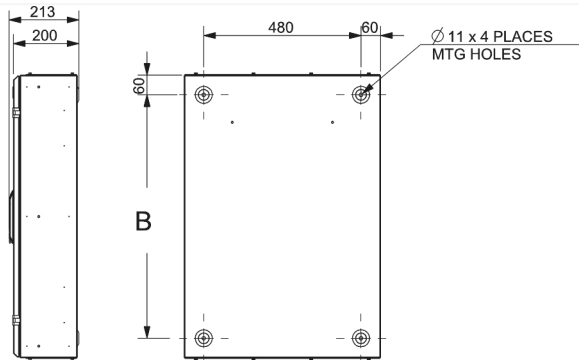

| Module Size | A | B |
|-------------|--------|--------|
| 2 | 432mm | 312mm |
| 3 | 648mm | 528mm |
| 4 | 864mm | 744mm |
| 5 | 1080mm | 960mm |
| 6 | 1296mm | 1176mm |
| 7 | 1512mm | 1392mm |
| 8 | 1728mm | 1608mm |
| 9 | 1944mm | 1824mm |

Plan view



Dimension Diagram