

Catalogue No: **CPL-24M160-G**

C/PLUS PBOARD DIN-T 24W 160A MSW 3M-648mm GREY

Power Distribution and Protection > Distribution Boards > Panelboards > CONCEPT PLUS Panelboard > Concept Plus Panelboard CPL > Grey - Mild Steel



CONCEPT PLUS Panelboard, IP42, DIN-T 24-Way 250 A NC Chassis, 160 A Isolator Main Switch, 3M-648 mm, Storm Grey (N42)

- Standard AS/NZS 61439-3
- Partial type tested busbar system
- Option - Compact 160 A or 250 A main switch
- Option - Isolator or circuit breaker main switch
- Modular sizes up to 96-Way
- Knockouts for up to 18 modules DIN equipment
- Accessory modules
- Removable gland plates
- Door fitted independent of escutcheon
- Right hand door hinging
- Semi flush door swing handle
- IP42 (option IP52)
- Chassis tee-off isolator option

Representative Photo Only
(actual product may vary based on configuration selections)

SPECIFICATIONS

Product Series	Concept Plus
Component Type Power Distribution & Protection	Panelboard
Chassis Type	Encapsulated
IP Rating	IP42
IP rating, with door	IP42
IP rating, without door	IP30
Number of Poles	24
Box Size	3
Number of Modules	3 qty
Height	648 mm
Depth, Including Door	200 mm, incl door
Depth, Door	20 mm depth
MCB Type	DIN Profile
Main Switch Type	Isolator Main Switch
In, Rated Current, Main Switch	160 A
Product series, chassis	NC
In, rated current, busbar	250 A
Icw, Busbar Withstand Current, 100ms (rms)	25 kA for 100ms
Segregation Form Rating	1
Material	Powder Coated Mild Steel
Material Thickness	1.6 mm
Material, Base	Mild Steel
Material Thickness, Base	1.6 mm
Finish, Base	Powder Coated (Polyester) base
Colour, Base	Storm Grey (N42) base
Material, door	Mild Steel
Material thickness, door	1.6 mm
Finish, Door	Powder Coated (Polyester) door

Catalogue No: **CPL-24M160-G**

C/PLUS PBOARD DIN-T 24W 160A MSW 3M-648mm GREY

Power Distribution and Protection > Distribution Boards > Panelboards > CONCEPT PLUS Panelboard > Concept Plus Panelboard CPL > Grey - Mild Steel



Colour, Door	Storm Grey (N42) door
Door Handle Type	Semi flush keyed CL001 quarter turn
Door hinged independent escutcheon	Yes, from RH side standard
Escutcheon	Bright white gloss hinged RH side
Material, Escutcheon	Mild Steel
Material Thickness, Escutcheon	1.2 mm
Finish, Escutcheon	Powder Coated (Polyester) escutcheon
Colour, Escutcheon	White escutcheon
Gland Plate/End Cap	Removable 1.6 mm mild steel, top/bottom
Spare DIN rail space (free poles)	18
Earth and Neutral bar Rating	250 A Bar, 2 screw tunnel terminals (M8 studs top and bottom, spare 1 x 25 mm + 1 x 16 mm, 2 x 25 mm tunnel terminals and remainder 2 screw 16 mm tunnel terminals)
Ue, rated operational voltage, AC, 1ph, nom	240 V AC
Ue, rated operational voltage, AC, 3ph, nom	415 V AC
Width	600 mm
Standards Compliance	AS/NZS 61439.3

REFERENCES

IECEx Certificate	-
Supplier Declaration of Conformity:	-
Installation Guide:	-
User Manual:	-
Manufacturer Datasheet:	-
Manufacturer Catalogue & Product Selection:	-

Catalogue No: **CPL-24M160-G**

C/PLUS PBOARD DIN-T 24W 160A MSW 3M-648mm GREY

Power Distribution and Protection > Distribution Boards > Panelboards > CONCEPT PLUS Panelboard > Concept Plus Panelboard CPL > Grey - Mild Steel

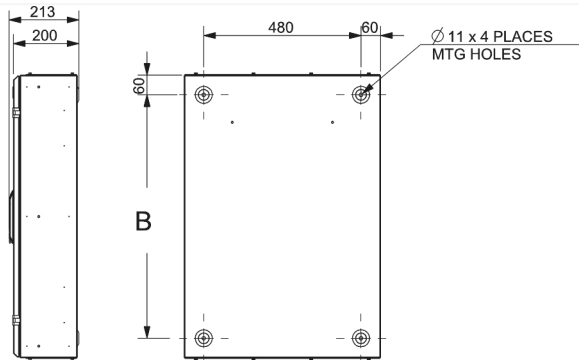

Module Size	A	B
2	432mm	312mm
3	648mm	528mm
4	864mm	744mm
5	1080mm	960mm
6	1296mm	1176mm
7	1512mm	1392mm
8	1728mm	1608mm
9	1944mm	1824mm

Plan view



Dimension Diagram