

IEC Type 5 A Solid-core Current Transformer



NOTE: Models of selected commercial references are shown here.

NOTE: Do not use the product if it is damaged. Contact Schneider Electric customer care representative for support (www.se.com/support).



The CE and UKCA marking indicates RoHS compliance as per latest EU RoHS directive.



The IEC type 5 A solid-core Current Transformer (CT) delivers secondary current (Is) of 0 to 5 A that is proportional to the current measured at the primary (Ip). The IEC type 5 A solid-core current transformer is used in combination with measurement equipments like Ammeters, Kilowatt-hour meters, Measurement units, Control relays.

The CT selection depends on the conductor profile and the maximum intensity of the primary circuit.

NOTE: Recommended to choose the CT ratio higher than the maximum load current.

1 Safety Precautions



HAZARD OF ELECTRIC SHOCK, EXPLOSION, OR ARC FLASH

- Apply appropriate personal protective equipment (PPE) and follow safe electrical work practices. See NFPA 70E in the USA or applicable local standards.
- This equipment must only be installed and serviced by qualified electrical personnel.
- Turn off all power supplying equipment before working on or inside the equipment.
- Product may use multiple voltage/power sources. Disconnect ALL sources before servicing.
- Use a properly rated voltage sensing device to confirm that power is off. DO NOT depend on this product for voltage indication.
- Current transformer secondaries must be shorted or connected to a low burden at all times.
- Products rated only for basic insulation must be installed on insulated conductors.
- Replace all doors, covers and protective devices before powering the equipment.
- This product must be installed inside a suitable fire and electrical enclosure.
- This product is not intended for life or safety applications.

Failure to follow these instructions will result in death or serious injury.



RISK OF INJURY OR EQUIPMENT DAMAGE

- Do not apply current transformers to circuits having a phase-to-phase voltage greater than their voltage rating unless adequate additional insulation is applied between the primary conductor and the current transformers.
- Always open or disconnect circuit from power-distribution system (or service) of building before installing of servicing current transformers to reduce the risk of electric shock.
- The current transformers must not be installed in equipment where they exceed 75 percent of the wiring space of any cross-sectional area within the equipment.
- Restrict the installation of current transformers in an area where it would block ventilation openings.
- Restrict the installation of current transformer in area of breaker arc venting.
- Not suitable for Class 2 wiring methods and Not intended for connection to Class 2 equipment.
- Secure current transformer and route conductors so that they do not directly contact live terminals or bus (optional).

Failure to follow these instructions may result in injury, fire or equipment damage.

2 Dimensions

NOTE: All dimensions are in mm (For inch conversion: 1 inch = 25.4 mm).

NOTE: Refer to section 5 for detailed commercial reference information.

Solid-core CTs

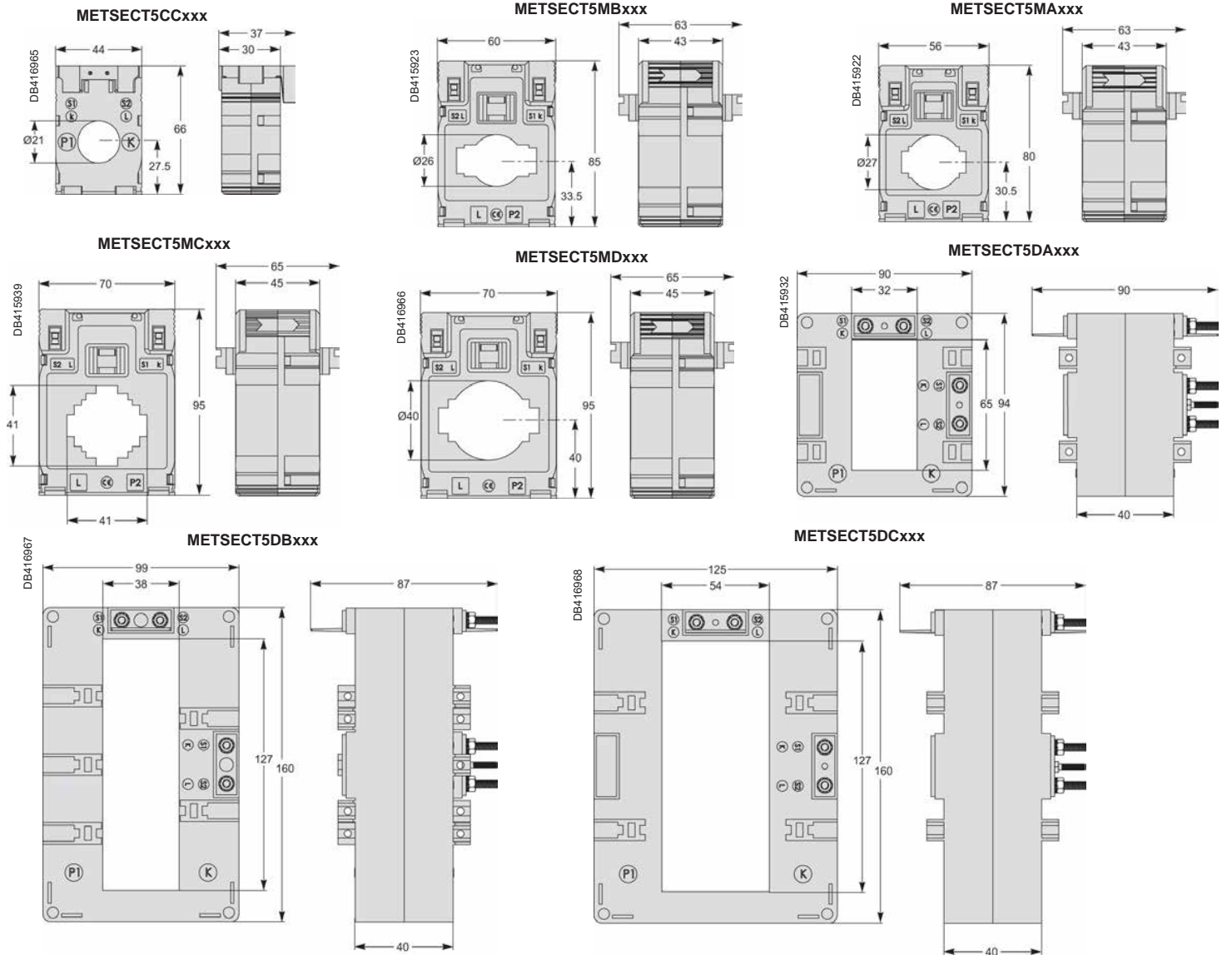

2 Dimensions

NOTE: All dimensions are in mm (For inch conversion: 1 inch = 25.4 mm).

NOTE: Refer to section 5 for detailed commercial reference information.

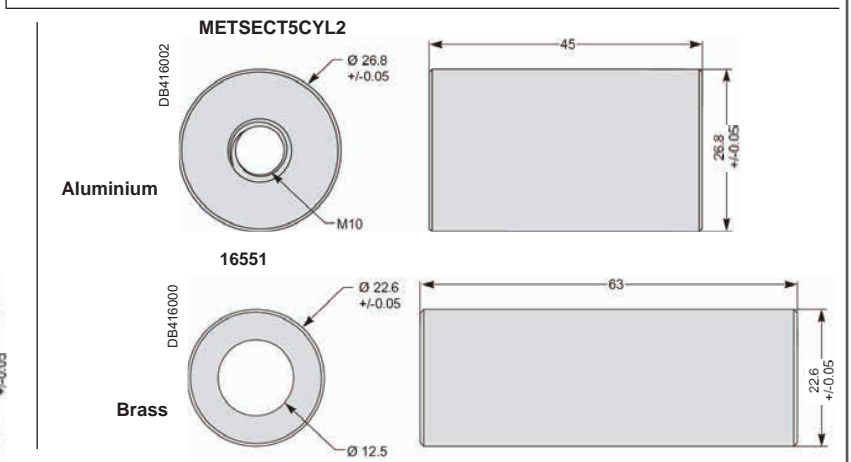
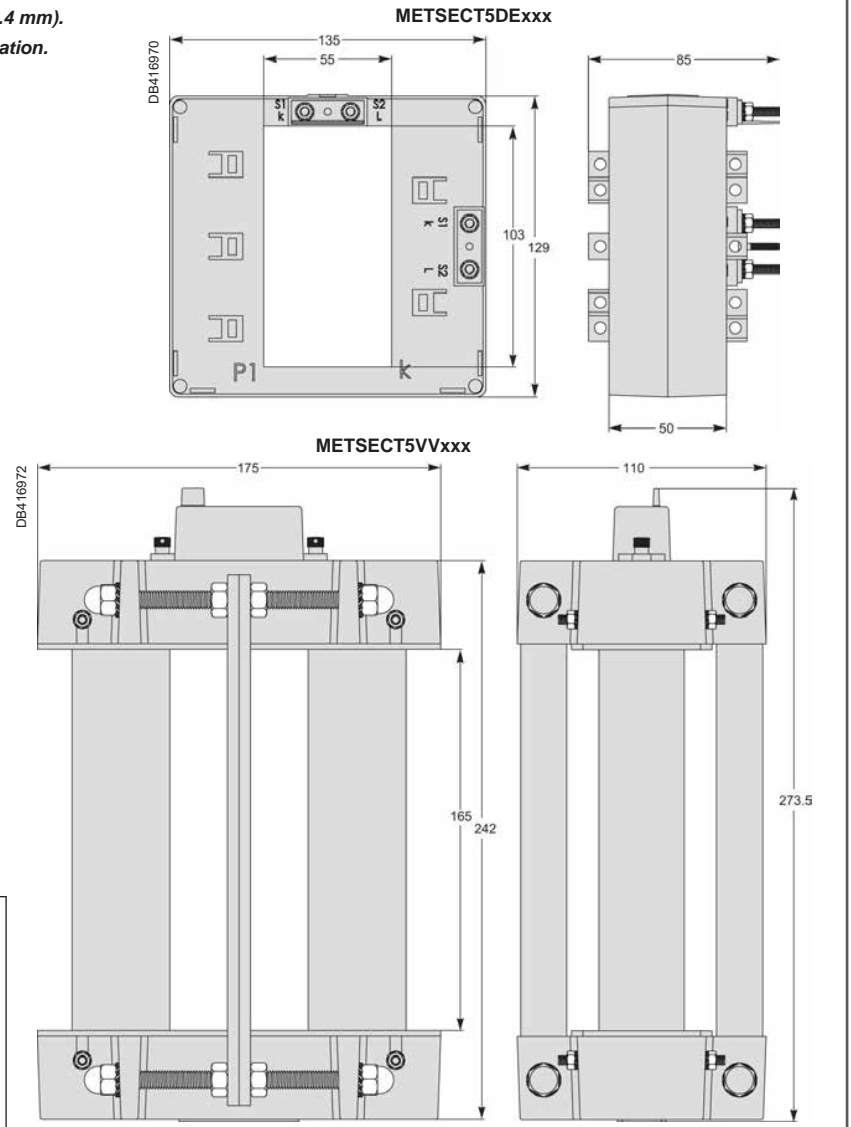
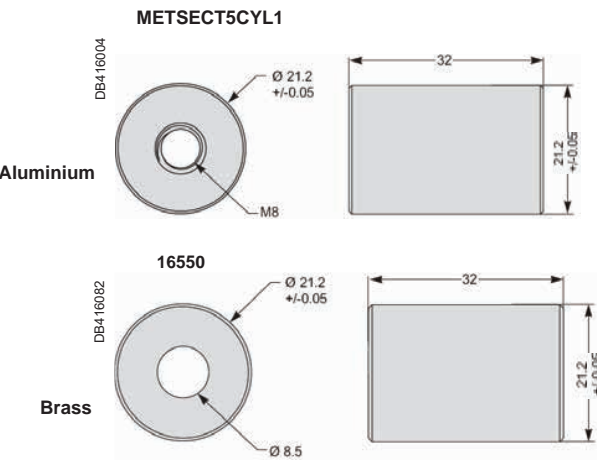
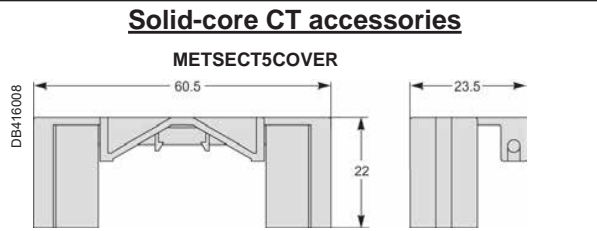
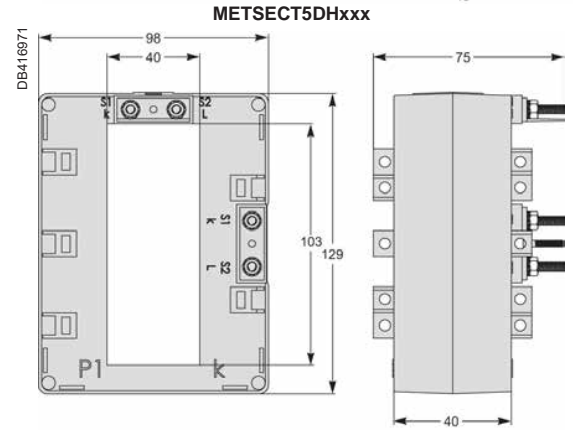
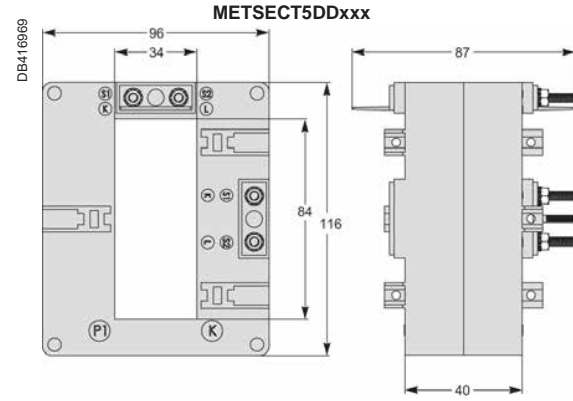

3 Mounting

Panel mounting

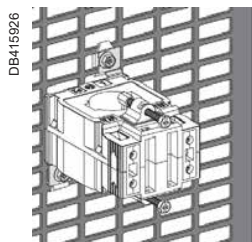

DIN rail mounting

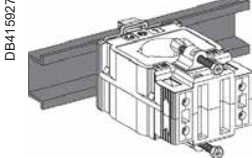

Specific mounting: use of cylinder

A cylindrical metallic spacer ensures a proper CT positioning when the conductor or the CT cannot be positioned perpendicular. Secured with the bolt and nut.

CT with primary connection by screw and nut (example: use of cylinder with bar or cable)

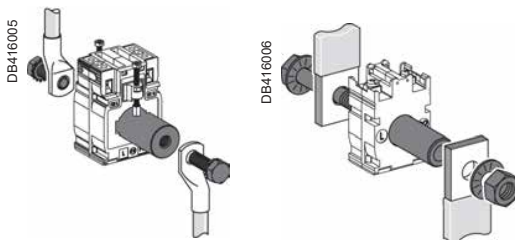

METSECT5CYL1 (Aluminium)

16550 (brass)

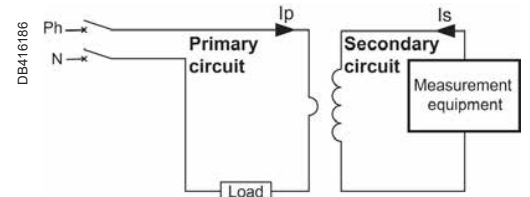

4 CT principle



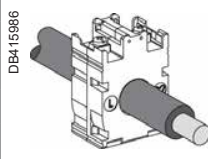

When the primary circuit is energized, the measurement equipment acts as a short circuit which keeps the secondary voltage very low. This voltage increases significantly if the short circuit is removed.

NOTE: Always keep the secondary circuit connected to low impedance path or short the current signal terminals of the measuring instrument.

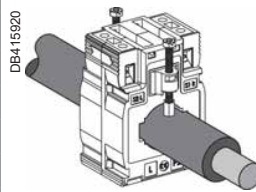
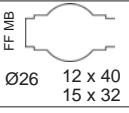
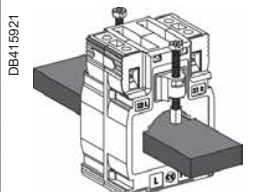
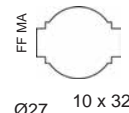
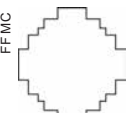
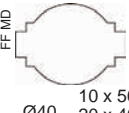
5 CT description

CT with let-through primary	CT internal type	Internal profile type and dimension in mm	Fastening mode	Ip/5 A rating (A)*	Accuracy class VA rating			CT Commercial reference	Accessories commercial reference	
					0.5	1	3		Cylinder	Sealable cover
Type C - solid-core CT (cable profile)										
	CC	 FFCC Ø21	<ul style="list-style-type: none"> • Adapter for DIN rails • Mounting plate 	40	-	-	1	METSECT5CC004	METSECT5CYL1	Included
				50	-	1.25	1.5	METSECT5CC005		
				60	-	1.25	2	METSECT5CC006		
				75	-	1.5	2.5	METSECT5CC008		
				100	2	2.5	3.5	METSECT5CC010		
				125	2.5	3.5	4	METSECT5CC013		
				150	3	4	5	METSECT5CC015		
				200	4	5.5	6	METSECT5CC020		
250	5	6	7	METSECT5CC025						
Type M - solid-core CT (mixed: cable/bar profile)										
	MB	 FFMB Ø26 12 x 40 15 x 32	<ul style="list-style-type: none"> • Adapter for DIN rails • Mounting plate 	250	3	4	-	METSECT5MB025	-	METSECT5COVER
				300	4	6	-	METSECT5MB030		
				400	6	8	-	METSECT5MB040		
	150	3		5	-	METSECT5MA015				
	200	4		7	-	METSECT5MA020				
	250	6		8	-	METSECT5MA025				
	MA	 FFMA Ø27 10 x 32 15 x 25	<ul style="list-style-type: none"> • Adapter for DIN rails • Mounting plate 	300	8	10	-	METSECT5MA030	METSECT5CYL2	METSECT5COVER
				400	10	12	-	METSECT5MA040		
				250	3	5	-	METSECT5MC025		
	300	5		8	-	METSECT5MC030				
	400	8		10	-	METSECT5MC040				
	500	10		12	-	METSECT5MC050				
MC	 FFMC Ø32 10 x 40 20 x 32 25 x 25	-	METSECT5COVER	600	12	15	-	METSECT5MC060		
				800	10	12	-	METSECT5MC080		
				500	4	6	-	METSECT5MD050		
				600	6	8	-	METSECT5MD060		
MD	 FFMD Ø40 10 x 50 20 x 40	-	METSECT5COVER	800	10	12	-	METSECT5MD080		

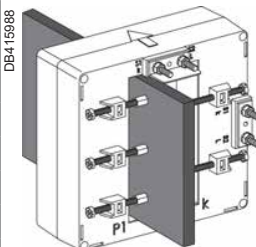
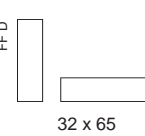
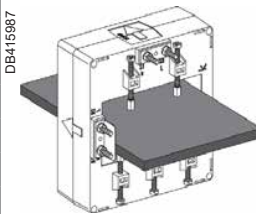
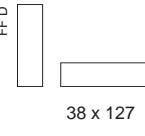
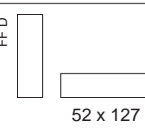
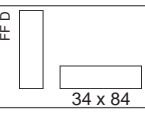
Type D** - solid-core CT (vertical or horizontal bar - dual secondary terminals)

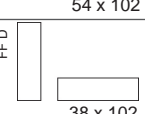
	DA	 FFD 32 x 65	Insulated locking screw	400	4	8	-	METSECT5DA040	-	Included
				500	8	10	-	METSECT5DA050		
				600	8	12	-	METSECT5DA060		
				800	12	15	-	METSECT5DA080		
				1000	15	20	-	METSECT5DA100		
				1250	15	20	-	METSECT5DA125		
	DB	 FFD 38 x 127	Insulated locking screw	1500	20	25	-	METSECT5DA150	-	Included
				1000	6	10	-	METSECT5DB100		
				1250	8	12	-	METSECT5DB125		
				1500	10	15	-	METSECT5DB150		
				2000	15	20	-	METSECT5DB200		
				2500	20	25	-	METSECT5DB250		
DC	 FFD 52 x 127	Insulated locking screw	-	3000	25	30	-	METSECT5DC200		
				2500	30	50	-	METSECT5DC250		
				3000	30	50	-	METSECT5DC300		
				4000	30	50	-	METSECT5DC400		
DD	 FFD 34 x 84	Insulated locking screw	-	1000	10	15	-	METSECT5DD100		
				1250	12	15	-	METSECT5DD125		
				1500	15	20	-	METSECT5DD150		
DE	 FFD 54 x 102	Insulated locking screw	-	1000	12	15	-	METSECT5DE100		
				1250	15	20	-	METSECT5DE125		
				1500	20	25	-	METSECT5DE150		
DH	 FFD 38 x 102	Insulated locking screw	-	2000	20	25	-	METSECT5DE200		
				1250	12	15	-	METSECT5DH125		
				1500	12	15	-	METSECT5DH150		
				2000	20	25	-	METSECT5DH200		Included

* Maximum rated current (Imax) is 1.2 times of the primary current (Ip).

** Two pairs of secondary connectors are provided (parallel internal wiring - only one secondary winding) for easier cable access. One lateral and one on extremity.

NOTE: Only one pair of secondary connector must be used at a time.

5 CT description

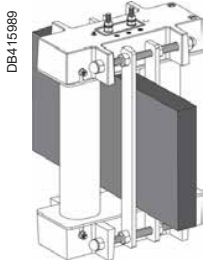
CT with let-through primary	CT internal type	Internal profile type and dimension in mm	Fastening mode	Ip/5 A rating (A)*	Accuracy class VA rating			CT Commercial reference	Accessories commercial reference	
					0.5	1	3		Cylinder	Sealable cover
Type V - solid-core CT (vertical bar profile)										
	VV	55 x 165	Insulated locking screw	5000	60	-	-	METSECT5VV500	-	Included
				6000	70	-	-	METSECT5VV600		

* Maximum rated current (Imax) is 1.2 times of the primary current (Ip).

6 Installation

1. Turn off and lock out power to the primary circuit before installing the CT.
2. Use a properly rated voltage sensing device to confirm that power is off.
3. Connect the secondary output terminals of the CT to the respective current input terminals of the measuring instruments. Follow local / IEC guidelines on looping S2 terminals at CT, instruments and connect through the CT shorting block.
4. Route the primary conductor through the center of the CT and complete the conductor connections. Ensure that the direction of the primary conductor is in line with the indication given on the CT.
6. Reconnect power and follow the installation guidelines for energizing the panel.

7 Specifications

- Secondary current Is (A): 5 A
- Maximum voltage rating Ue (V): 720 V
- Frequency: 50 / 60 Hz (Range: 47 - 63 Hz)
- Instrument security / Safety factor (sf):
40 to 4000 A: ≤5
5000 to 6000 A: ≤10
- Rated short time thermal current: 60 times the Ip current for 1 second (max 60 kA)
- Dielectric strength test: 3 kV, 50 Hz for one minute
- Rated dynamic current (Idyn): 2.5 Ith
- Degree of protection: IP20
- Operating temperature:
For Ip up to 1000 A: -25 to +60 °C (-13 to +140 °F)
For Ip from 1250 A to 6000 A: -25 to +50 °C (-13 to +122 °F)
- Storage temperature: -40 to +85 °C (-40 to +185 °F)
- 5% to 95% RH non-condensing
- Standard compliance: IEC 61869-2, VDE 0414
- Altitude of Operation: 3000 m (9843 ft)
- Pollution degree 2
- Insulation class: B
- Installation category III
- For indoor use only
- Secondary connection: by terminals for lug or by tunnel terminals or by screws

China ROHS Certificate

The "Administrative Measures for the Restriction of Hazardous Substances in Electric Appliance and Electronic Products" requires this document to be shipped with all IEC Type 5 A Solid-core Current Transformer products to the People's Republic of China. Purchasers in other countries may disregard.

Les "Administrative Measures for the Restriction of Hazardous Substances in Electric Appliances and Electronic Products" exige que ce document soit transporté avec tous les produits de IEC Type 5 A Solid-core Current Transformer en République Populaire de Chine. Les acheteurs des autres pays peuvent le négliger.

Las "Administrative Measures for the Restriction of Hazardous Substances in Electric Appliances and Electronic Products" requiere que este documento sea enviado con todos los productos IEC Type 5 A Solid-core Current Transformer a la República Popular de China. Los usuarios en otros países pueden ignorar este documento.

Product/ Produit/ Producto: IEC Type 5 A Solid-core Current Transformer

产品系列: 电力量度器仪及配件



部件名称 / Part Name	产品中有毒有害物质或元素的名称及含量 / Hazardous Substances					
	铅 (Pb)	汞 (Hg)	镉 (Cd)	六价铬 (Cr(VI))	多溴联苯 (PBB)	多溴二苯醚 (PBDE)
金属部件 / Metal parts	O	O	O	O	O	O
塑料部件 / Plastic parts	O	O	O	O	O	O
电子线路板 / PCBA	X	O	O	O	O	O

本表格依据SJ/T11364的规定编制。

O = 表示该有毒有害物质在该部件所有均质材料中的含量均在 SJ/T11363-2006 标准规定的限量要求以下。

X = 表示该有毒有害物质至少在该部件的某一均质材料中的含量超出SJ/T11363-2006标准规定的限量要求。

This table is made according to SJ/T 11364.

O: indicates that the concentration of hazardous substance in all of the homogeneous materials for this part is below the limit as stipulated in GB/T 26572.

X: indicates that concentration of hazardous substance in at least one of the homogeneous materials used for this part is above the limit as stipulated in GB/T 26572.

Notices

Read these instructions carefully and look at the equipment to become familiar with the device before trying to install, operate, service or maintain it.

Electrical equipment should be installed, operated, serviced and maintained only by qualified personnel. No responsibility is assumed by Schneider Electric for any consequences arising out of the use of this material. A qualified person is one who has skills and knowledge related to the construction, installation, and operation of electrical equipment and has received safety training to recognize and avoid the hazards involved.

Schneider Electric is the trademark or registered trademark of Schneider Electric in France, the USA and other countries.

- This product must be installed, connected and used in compliance with prevailing standards and/or installation regulations.
- If this product is used in a manner not specified by the manufacturer, the protection provided by the product may be impaired.
- The safety of any system incorporating this product is the responsibility of the assembler/installer of the system.

As standards, specifications and designs change from time to time, always ask for confirmation of the information given in this publication.