

ATV212WD45N4

variable speed drive ATV212 - 45kW - 60hp - 480V - 3ph - EMC class C2 - IP55



Main

Range of product	Altivar 212
Product or component type	Variable speed drive
Device short name	ATV212
Product destination	Asynchronous motors
Product specific application	Pumps and fans in HVAC
Assembly style	With heat sink
Network number of phases	3 phases
Motor power kW	45 kW
Motor power hp	60 hp
[Us] rated supply voltage	380...480 V - 15...10 %
Supply voltage limits	323...528 V
Supply frequency	50...60 Hz - 5...5 %
Network frequency	47.5...63 Hz
EMC filter	Class C2 EMC filter integrated
Line current	83.8 A 380 V 65.9 A 480 V

Complementary

Apparent power	61.9 kVA 380 V
Prospective line I _{sc}	22 kA
Continuous output current	94 A 380 V 94 A 460 V
Maximum transient current	103.4 A 60 s
Speed drive output frequency	0.5...200 Hz
Nominal switching frequency	8 kHz
Switching frequency	6...16 kHz adjustable 8...16 kHz with derating factor
Speed range	1...10
Speed accuracy	+/- 10 % of nominal slip 0.2 T _n to T _n
Torque accuracy	+/- 15 %
Transient overtorque	120 % of nominal motor torque +/- 10 % 60 s
Asynchronous motor control profile	Voltage/frequency ratio, 2 points Voltage/frequency ratio, 5 points Flux vector control without sensor, standard Voltage/frequency ratio - Energy Saving, quadratic U/f Voltage/frequency ratio, automatic IR compensation (U/f + automatic U ₀)
Regulation loop	Adjustable PI regulator
Motor slip compensation	Adjustable Automatic whatever the load Not available in voltage/frequency ratio motor control
Local signalling	1 LED red DC bus energized
Output voltage	<= power supply voltage
Isolation	Electrical between power and control
Type of cable	IEC cable without mounting kit 1 45 °C copper 90 °C XLPE/EPR IEC cable without mounting kit 1 45 °C copper 70 °C PVC UL 508 cable with UL Type 1 kit 3 40 °C copper 75 °C PVC
Electrical connection	Terminal 2.5 mm ² AWG 14 VIA, VIB, FM, FLA, FLB, FLC, RY, RC, F, R, RES Terminal 50 mm ² AWG 1/0 L1/R, L2/S, L3/T
Tightening torque	24 N.m 212 lb.in L1/R, L2/S, L3/T

The information provided in this documentation contains general descriptions and/or technical characteristics of the products contained herein. This documentation is not intended as a substitute for and is not to be used for determining suitability or reliability of these products for specific user applications. It is the duty of any such user or integrator to perform the appropriate and complete risk analysis, evaluation and testing of the products with respect to the relevant specific application or use thereof. Neither Schneider Electric Industries SAS nor any of its affiliates or subsidiaries shall be responsible or liable for misuse of the information contained herein.

Supply	Internal supply for reference potentiometer (1 to 10 kOhm) 10.5 V DC +/- 5 % <= 10 A overload and short-circuit protection Internal supply 24 V DC 21...27 V <= 200 A overload and short-circuit protection
Analogue input number	2
Analogue input type	Switch-configurable voltage VIA 0...10 V DC 24 V max 30000 Ohm 10 bits Configurable voltage VIB 0...10 V DC 24 V max 30000 Ohm 10 bits Configurable PTC probe VIB 0...6 probes 1500 Ohm Switch-configurable current VIA 0...20 mA 250 Ohm 10 bits
Sampling duration	2 ms +/- 0.5 ms F discrete 2 ms +/- 0.5 ms R discrete 2 ms +/- 0.5 ms RES discrete 3.5 ms +/- 0.5 ms VIA analog 22 ms +/- 0.5 ms VIB analog
Response time	2 ms +/- 0.5 ms FM analog 7 ms +/- 0.5 ms FLA, FLC discrete 7 ms +/- 0.5 ms FLB, FLC discrete 7 ms +/- 0.5 ms RY, RC discrete
Accuracy	+/- 0.6 % VIA for a temperature variation 60 °C +/- 0.6 % VIB for a temperature variation 60 °C +/- 1 % FM for a temperature variation 60 °C
Linearity error	+/- 0.15 % of maximum value input VIA +/- 0.15 % of maximum value input VIB +/- 0.2 % output FM
Analogue output number	1
Analogue output type	Switch-configurable voltage FM 0...10 V DC 7620 Ohm 10 bits Switch-configurable current FM 0...20 mA 970 Ohm 10 bits
Discrete output number	2
Discrete output type	Configurable relay logic FLA, FLC NO 100000 cycles Configurable relay logic FLB, FLC NC 100000 cycles Configurable relay logic RY, RC NO 100000 cycles
Minimum switching current	3 mA 24 V DC configurable relay logic
Maximum switching current	5 A 250 V AC resistive cos phi = 1 L/R = 0 ms FL, R 5 A 30 V DC resistive cos phi = 1 L/R = 0 ms FL, R 2 A 250 V AC inductive cos phi = 0.4 L/R = 7 ms FL, R 2 A 30 V DC inductive cos phi = 0.4 L/R = 7 ms FL, R
Discrete input type	Programmable F 24 V DC level 1 PLC 4700 Ohm Programmable R 24 V DC level 1 PLC 4700 Ohm Programmable RES 24 V DC level 1 PLC 4700 Ohm
Discrete input logic	Positive logic (source) F, R, RES <= 5 V >= 11 V Negative logic (sink) F, R, RES >= 16 V <= 10 V
Acceleration and deceleration ramps	Automatic based on the load Linear adjustable separately from 0.01 to 3200 s
Braking to standstill	By DC injection
Protection type	Input phase breaks drive Line supply overvoltage and undervoltage drive Line supply undervoltage drive Overcurrent between output phases and earth drive Overheating protection drive Short-circuit between motor phases drive Thermal protection motor Motor phase break motor Break on the control circuit drive Thermal power stage drive Overvoltages on the DC bus drive Against exceeding limit speed drive Against input phase loss drive With PTC probes motor
Dielectric strength	3535 V DC between earth and power terminals 5092 V DC between control and power terminals
Insulation resistance	>= 1 MOhm 500 V DC for 1 minute
Frequency resolution	0.1 Hz display unit 0.024/50 Hz analog input
Communication port protocol	APOGEE FLN BACnet LonWorks METASYS N2 Modbus
Connector type	1 RJ45

	1 open style
Physical interface	2-wire RS 485
Transmission frame	RTU
Transmission rate	9600 bps or 19200 bps
Data format	8 bits, 1 stop, odd even or no configurable parity
Type of polarization	No impedance
Number of addresses	1...247
Communication service	Monitoring inhibitable Read device identification (43) Read holding registers (03) 2 words maximum Time out setting from 0.1 to 100 s Write multiple registers (16) 2 words maximum Write single register (06)
Option card	Communication card LonWorks
Operating position	Vertical +/- 10 degree
Width	284 mm
Height	880 mm
Depth	343 mm
Functionality	Mid
Specific application	HVAC
IP degree of protection	IP55

Environment

electromagnetic compatibility	1.2/50 μ s - 8/20 μ s surge immunity test level 3 IEC 61000-4-5 Electrical fast transient/burst immunity test level 4 IEC 61000-4-4 Electrostatic discharge immunity test level 3 IEC 61000-4-2 Radiated radio-frequency electromagnetic field immunity test level 3 IEC 61000-4-3 Conducted radio-frequency immunity test level 3 IEC 61000-4-6 Voltage dips and interruptions immunity test IEC 61000-4-11
pollution degree	3 IEC 61800-5-1
IP degree of protection	IP55 EN/IEC 61800-5-1 IP55 EN/IEC 60529
vibration resistance	1.5 mm 3...13 Hz EN/IEC 60068-2-6 1 gn 13...200 Hz EN/IEC 60068-2-8
shock resistance	15 gn 11 ms IEC 60068-2-27
environmental characteristic	Classes 3C1 IEC 60721-3-3 Classes 3S2 IEC 60721-3-3
noise level	64 dB 86/188/EEC
operating altitude	<= 1000 m without derating 1000...3000 m limited to 2000 m for the Corner Grounded distribution network with current derating 1 % per 100 m
relative humidity	5...95 % without condensation IEC 60068-2-3 5...95 % without dripping water IEC 60068-2-3
ambient air temperature for operation	-10...40 °C without derating > 40...50 °C with derating factor
ambient air temperature for storage	-25...70 °C
standards	EN 55011 class A group 1 EN 61800-3 EN 61800-3 category C2 EN 61800-3 category C3 EN 61800-3 environments 1 category C1 EN 61800-3 environments 1 category C2 EN 61800-3 environments 1 category C3 EN 61800-3 environments 2 category C1 EN 61800-3 environments 2 category C2 EN 61800-3 environments 2 category C3 EN 61800-5-1 IEC 61800-3 IEC 61800-3 category C2 IEC 61800-3 category C3 IEC 61800-3 environments 1 category C1 IEC 61800-3 environments 1 category C2 IEC 61800-3 environments 1 category C3 IEC 61800-3 environments 2 category C1 IEC 61800-3 environments 2 category C2 IEC 61800-3 environments 2 category C3

product certifications	CSA C-Tick NOM 117 UL
marking	CE

Offer Sustainability

Sustainable offer status	Green Premium product
RoHS (date code: YYWW)	Compliant - since 1112 - Schneider Electric declaration of conformity
REACH	Reference not containing SVHC above the threshold
Product environmental profile	Available
Product end of life instructions	Available

Dimensions

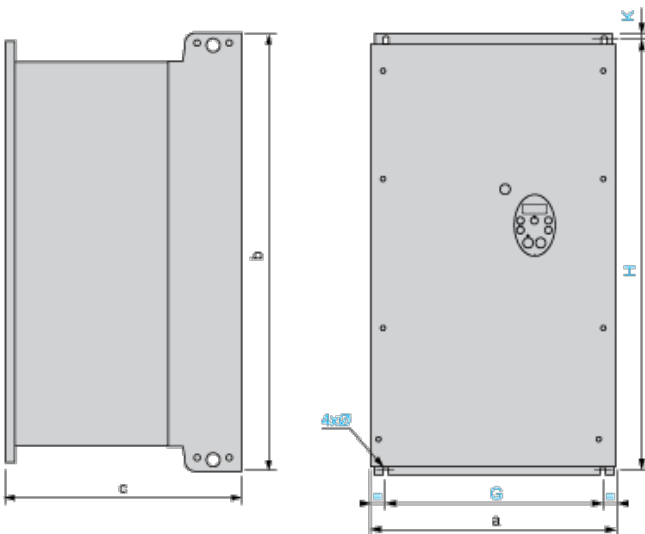

Dimensions in mm

ATV212W	a	b	c	G	H	K	ø
D11N4, D15N4 D11N4C, D15N4C	290	560	315	250	544	8	6
D18N4 D18N4C	310	665	315	270	650	10	6
D22N4, D30N4 D22N4C, D30N4C	284	720	315	245	700	10	7
D37N4, D45N4 D37N4C, D45N4C	284	880	343	245	860	10	7
D55N4, D75N4 D55N4C, D75N4C	362	1000	364	300	975	10	9

Dimensions in in.

ATV212W	a	b	c	G	H	K	ø
D11N4, D15N4 D11N4C, D15N4C	11.42	22.05	12.40	9.84	21.42	0.31	0.24
D18N4 D18N4C	12.20	26.18	12.40	10.63	25.59	0.39	0.24
D22N4, D30N4 D22N4C, D30N4C	11.18	28.35	12.40	9.65	27.56	0.39	0.27
D37N4, D45N4	11.18	34.65	13.50	9.65	33.86	0.39	0.27

D37N4C, D45N4C							
D55N4, D75N4	14.25	39.37	14.33	11.81	38.39	0.39	0.35
D55N4C, D75N4C							

Mounting Recommendations

Clearance

Depending on the conditions in which the drive is to be used, its installation will require certain precautions and the use of appropriate accessories.

Install the unit vertically:

- ▮ Do not place it close to heating elements.
- ▮ Leave sufficient free space to ensure that the air required for cooling purposes can circulate from bottom to the top of the unit.

Type A Mounting

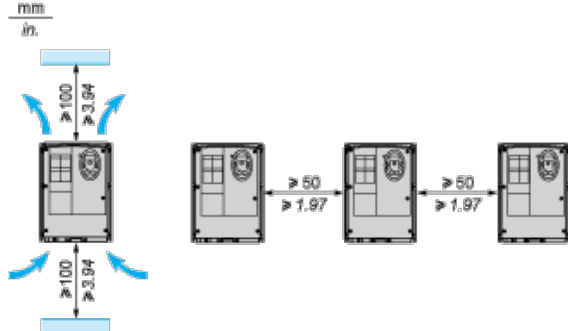

Recommended Wiring Diagram

3-Phase Power Supply

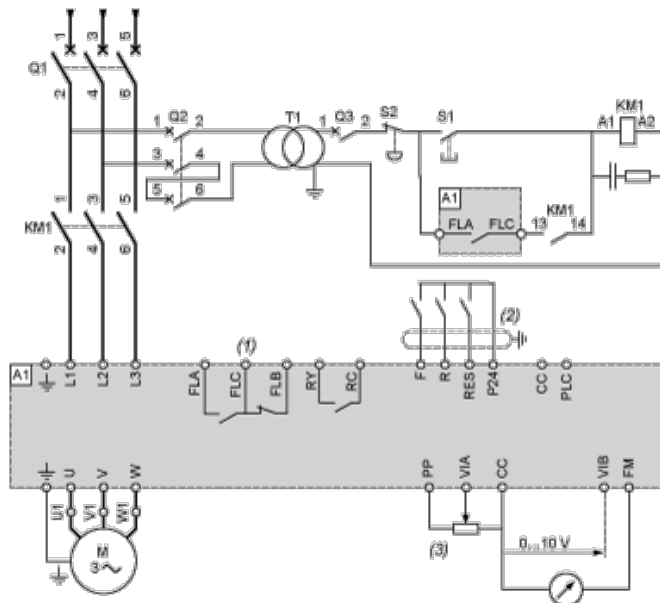

A1: ATV 212 drive

KM1: Contactor

Q1: Circuit breaker

Q2: GV2 L rated at twice the nominal primary current of T1

Q3: GB2CB05

S1, XB4 B or XB5 A pushbuttons

S2:

T1: 100 VA transformer 220 V secondary

(1) Fault relay contacts for remote signalling of the drive status

(2) Connection of the common for the logic inputs depends on the positioning of the switch (Source, PLC, Sink)

(3) Reference potentiometer SZ1RV1202

NOTE: All terminals are located at the bottom of the drive. Install interference suppressors on all inductive circuits near the drive or connected on the same circuit, such as relays, contactors, solenoid valves, fluorescent lighting, etc.

Switches (Factory Settings)

Voltage/current selection for analog I/O (VIA and VIB)



Voltage/current selection for analog I/O (FM)



Selection of logic type



- (1) negative logic
- (2) positive logic

Other Possible Wiring Diagrams

Logic Inputs According to the Position of the Logic Type Switch

“Source” position

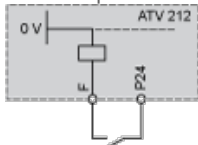

“Sink” position

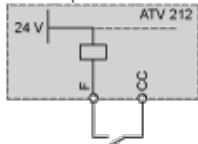

“PLC” position with PLC transistor outputs

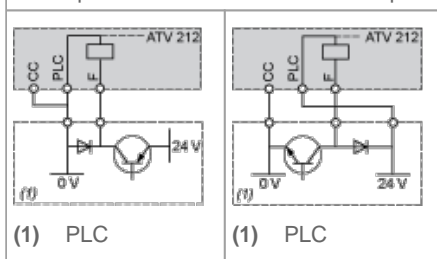

2-wire control

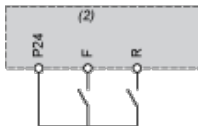

F: Forward

R: Preset speed

(2) ATV 212 control terminals

3-wire control

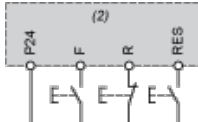

F: Forward

R: Stop

RES: Reverse

(2) ATV 212 control terminals

PTC probe

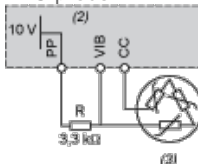

(2) ATV 212 control terminals

(3) Motor

Analog Inputs

Voltage analog inputs

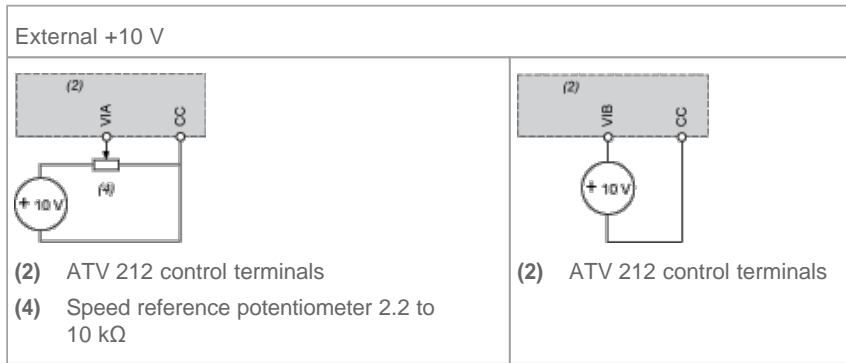

Analog input configured for current: 0-20 mA, 4-20 mA, X-Y mA

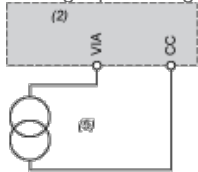

(2) ATV 212 control terminals

(5) Source 0-20 mA, 4-20 mA, X-Y mA

Analog input VIA configured as positive logic input ("Source" position)

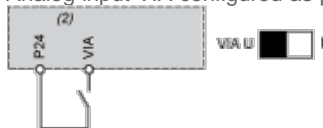

(2) ATV 212 control terminals

Analog input VIA configured as negative logic input ("Sink" position)

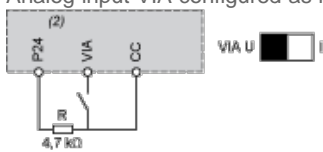

(2) ATV 212 control terminals

Derating Curves

The derating curves for the drive nominal current (I_n) depend on the temperature and the switching frequency.

For intermediate temperatures (45°C for example), interpolate between 2 curves.

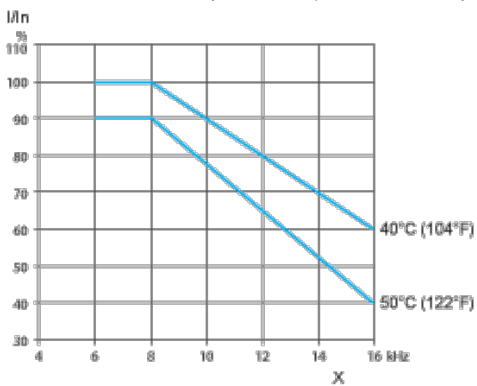

X Switching frequency