



S1A5382503

**⚡ ⚠ DANGER**

**HAZARD OF ELECTRIC SHOCK, EXPLOSION, OR ARC FLASH**

- Only appropriately trained persons who are familiar with and understand the contents of this manual and all other pertinent product documentation and who have received safety training to recognize and avoid hazards involved are authorized to work on and with this drive system. Installation, adjustment, repair and maintenance must be performed by qualified personnel.
- The system integrator is responsible for compliance with all local and national electrical code requirements as well as all other applicable regulations with respect to grounding of all equipment.
- Many components of the product, including the printed circuit boards, operate with mains voltage. Do not touch. Use only electrically insulated tools.
- Do not touch unshielded components or terminals with voltage present.
- Motors can generate voltage when the shaft is rotated. Prior to performing any type of work on the drive system, block the motor shaft to prevent rotation.
- AC voltage can couple voltage to unused conductors in the motor cable. Insulate both ends of unused conductors of the motor cable.
- Do not short across the DC bus terminals or the DC bus capacitors or the braking resistor terminals.
- Before performing work on the drive system:
  - Disconnect all power, including external control power that may be present.
  - Place a "Do Not Turn On" label on all power switches.
  - Lock all power switches in the open position.
  - Wait 15 minutes to allow the DC bus capacitors to discharge. The DC bus LED is not an indicator of the absence of DC bus voltage that can exceed 800 Vdc.
  - Measure the voltage on the DC bus between the DC bus terminals (PA/+ and PC/-) using a properly rated voltmeter to verify that the voltage is < 42 Vdc.
  - If the DC bus capacitors do not discharge properly, contact your local Schneider Electric representative.
- Install and close all covers before applying voltage.

**Failure to follow these instructions will result in death or serious injury.**

Electrical equipment should be installed, operated, serviced, and maintained only by qualified personnel. No responsibility is assumed by Schneider Electric for any consequences arising out of the use of this product.

Information below is designed to use **single drive** connected to **single asynchronous motor with a motor cable length less than 50 meters (164 ft)**. Check your cables before connecting the drive with motor (length, power, shielded or unshielded).

In any other case, consult the ATV212 installation manual ([S1A53832](#)) and programming manual ([S1A53838](#)) on [www.schneider-electric.com](http://www.schneider-electric.com).

## 1 Check the delivery of the drive

- Remove ATV212 from the packaging and check that it has not been damaged.

**⚠ WARNING**

**DAMAGED DRIVE EQUIPMENT**

Do not operate or install any drive or drive accessory that appears damaged.

**Failure to follow these instructions can result in death, serious injury, or equipment damage.**

- Check that the drive reference printed on the label is the same as that on the delivery note corresponding to the purchase order.

Write the drive Model Reference: \_\_\_\_\_ and Serial Number: \_\_\_\_\_

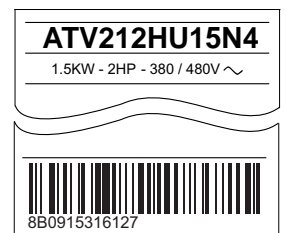

## 2 Check the line voltage compatibility

- Check that the **line voltage** is compatible with the supply range of the drive.  
 Line voltage \_\_\_\_\_ Volts    Drive voltage range \_\_\_\_\_ Volts  
 Drive range: ATV212 ●●●● M3X = 200/240 V three-phase / ATV212 ●●●● N4● = 380/480 V three-phase.

## 3 Mount the drive vertically

For a surrounding air temperature up to 40 °C (104 °F).

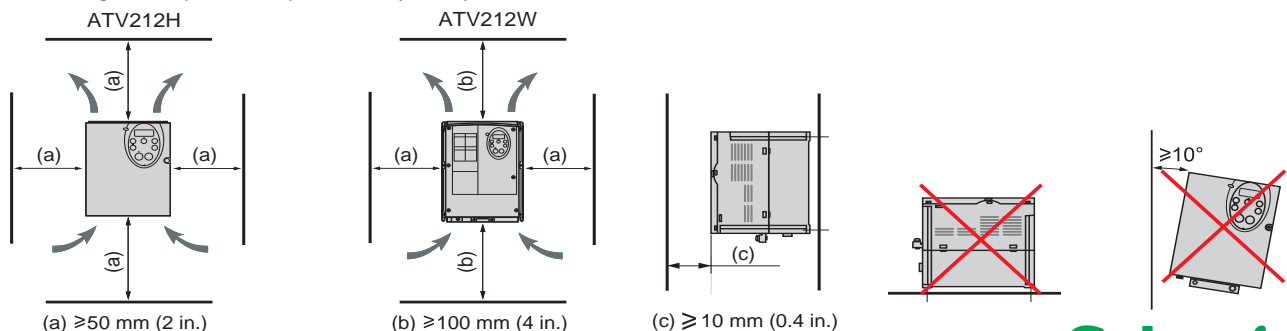

See installation manual ([S1A53832](#)) on [www.schneider-electric.com](http://www.schneider-electric.com) for other thermal conditions.

## 4 Connect the drive: Power

- Wire the drive to the ground.
- Check circuit breaker rating or fuse rating.
- Check that the motor voltage is compatible with the drive voltage.  
Motor voltage \_\_\_\_\_ Volts.
- Wire the drive to the motor.
- Wire the drive to the line supply.

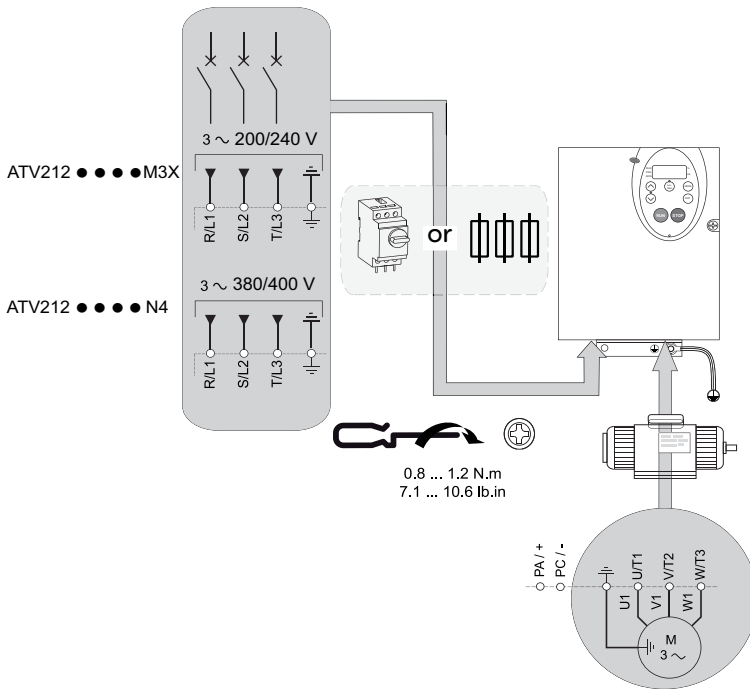

Note: for ATV212H075, ATV212HU15, ATV212HU22, to connect power, open the door, remove the terminal board, connect R/L1, S/L2, T/L3 and fix again the terminal board.

## 5 Connect the drive: Control choice

### 5.1 [REMOTE configuration] (Control by external reference)

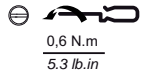

- Wire the speed reference:

PP: Internal supply for analogue inputs  
VIA: Analog/ logic input  
CC: Common

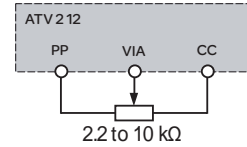

- Wire the command:

Control command 2-wire:

F: Run forward  
R: Run reverse  
P24: Internal supply for logic inputs

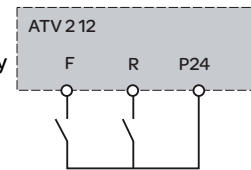

Do: 6 + 7 + 8 + 91

Control command 3-wire:

F: Run forward  
R: Stop  
RES: Run reverse  
P24: internal supply for logic inputs

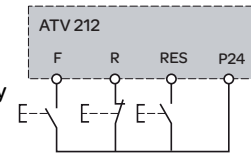

Do: 6 + 7 + 8 + 91

### 5.2 [LOCAL configuration] (control by internal reference).

Do: 6 + 7 + 8 + 92

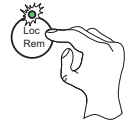

## 6 Apply power to the drive

- Check that used Logic Inputs are not active (see F, R, RES, P24, open circuit).
- Apply power to the drive.
- At each power on, drive displays **HELL** message, then run mode:



## 7 Set motor parameters

- See on the motor Nameplate to set the following parameters.

Menu	Code	Description	Factory setting	Customer setting
<b>A u F</b> [QUICK MENU]	<b>P L</b>	[Mot cont. mode sel.]: Motor control mode <b>0</b> [Constant V/Hz]: Constant V/Hz <b>1</b> [Variable Torque]: Variable torque <b>2</b> [Cst V/Hz+Boost]: Constant V/Hz with automatic torque boost <b>3</b> [SVC]: Sensorless vector control <b>4</b> [Economy]: Energy saving <b>5</b> [Reserved]: Reserved <b>6</b> [PM mode]: Permanent magnet	<b>1</b>	
	<b>u L</b>	[Motor rated Freq.]: Nominal motor frequency on motor nameplate (Hz)	<b>50.0</b>	
	<b>u L u</b>	[Motor Rated Voltage]: Nominal motor voltage on motor nameplate (V)	drive rating	
<b>F - - -</b> [EXTENDED MENU]	<b>F 4 I 5</b>	[Motor rated current]: Nominal motor current on motor nameplate (A)	drive rating	
	<b>F 4 I 7</b>	[Motor rated speed]: Nominal motor speed on motor nameplate (rpm)	drive rating	
	<b>F 6 0 1</b>	[Motor Current Limit]: Limit current during motoring or braking (%)	<b>110</b>	

## 7 Set motor parameters (continued)

Menu	Code	Description	Factory setting	Customer setting
<b>F - - -</b> [EXTENDED MENU]	<b>F 4 0 0</b>	Set <b>F 4 0 0</b> [Auto-tuning drive] parameter to <b>2</b> . The drive displays <b>A t n I</b> , the message disappears after a few seconds  Auto-Tuning for <b>u L u</b> , <b>u L</b> , <b>F 4 1 5</b> and <b>F 4 1 7</b>	<b>0</b>	

### ⚠️ ⚠️ DANGER

#### HAZARD OF ELECTRIC SHOCK OR ARC FLASH

- During auto-tuning, the motor operates at rated current.
- Do not service the motor during auto-tuning.

Failure to follow these instructions will result in death or serious injury.

### ⚠️ WARNING

#### DAMAGED DRIVE EQUIPMENT

- It is essential that the following parameters **u L u**, **u L**, **F 4 1 5** and **F 4 1 7** are correctly configured before starting autotuning.
- When one or more of these parameters have been changed after auto-tuning has been performed, **F 4 0 0** will return **0** and the procedure will have to be repeated.

Failure to follow these instructions can result in death, serious injury, or equipment damage.

## 8 Set basic parameters

Menu	Code	Description	Factory setting	Customer setting
<b>A u F</b> [QUICK MENU]	<b>A u 1</b>	[Auto ramp] Automatic ramp adaptation: <b>0</b> [Disabled] <b>1</b> [Enable] - (ACC) and (dEC) <b>2</b> [ACC only]	<b>1</b>	
	<b>A C C</b>	[Acceleration time 1]: Acceleration ramp and the time(s)	ATV212 ≤ 15KW = 10 s ATV212 ≥ 18KW = 30 s	
	<b>d E C</b>	[Deceleration time 1]: Deceleration ramp and the time (s)		
	<b>L L</b>	[Low limit frequency]: Motor frequency at minimum reference (Hz)	<b>0.0</b>	
	<b>u L</b>	[Upper limit freq]: Motor frequency at maximum reference (Hz)	<b>50.0</b>	
	<b>t H r</b>	[Motor thermal prot.]: Motor Rated Current Overload Setting (%)	<b>100</b>	
<b>F - - -</b> [EXTENDED MENU]	<b>F 3 0 0</b>	[Switch. freq. level] Switching Frequency Level (kHz) Increasing the switching frequency may reduce audible motor noise. See the derating curves in the ATV212 Installation Manual.	<b>8 to 12</b>	

## 9 Set control choice

### 91 [REMOTE configuration]

Parameters factory settings:

#### 2-wire control

Menu	Code	Setting
-	<b>C n o d</b> [Command mode sel]	<b>0</b> [Logic inputs]
<b>F - - -</b> [EXTENDED MENU]	<b>F 1 1 1</b> [LI F selection]	<b>2</b> [forward]
	<b>F 1 1 2</b> [LI R selection]	<b>3</b> [reverse]

#### 3-wire control

Menu	Code	Setting
-	<b>C n o d</b> [Command mode sel]	<b>0</b> [Logic inputs]
<b>F - - -</b> [EXTENDED MENU]	<b>F 1 1 1</b> [LI F selection]	<b>2</b> [forward]
	<b>F 1 1 2</b> [LI R selection]	<b>49</b> [3-wire]
	<b>F 1 1 3</b> [LI RES selection]	<b>3</b> [reverse]

### 92 [LOCAL configuration]

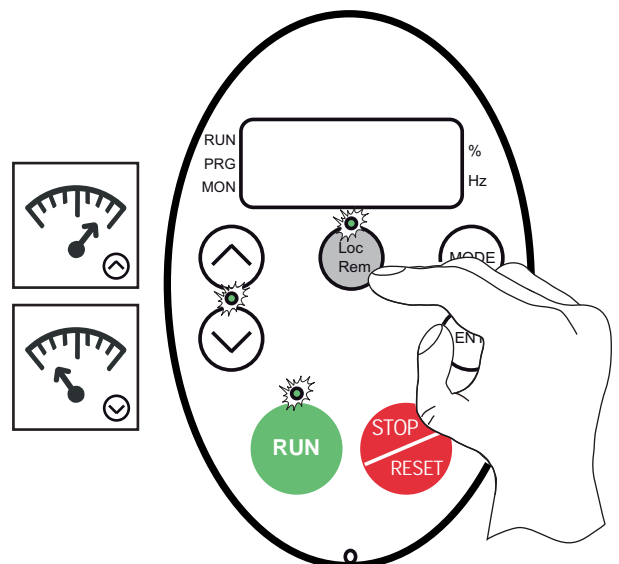

## 10 Start the motor

# Menus structure

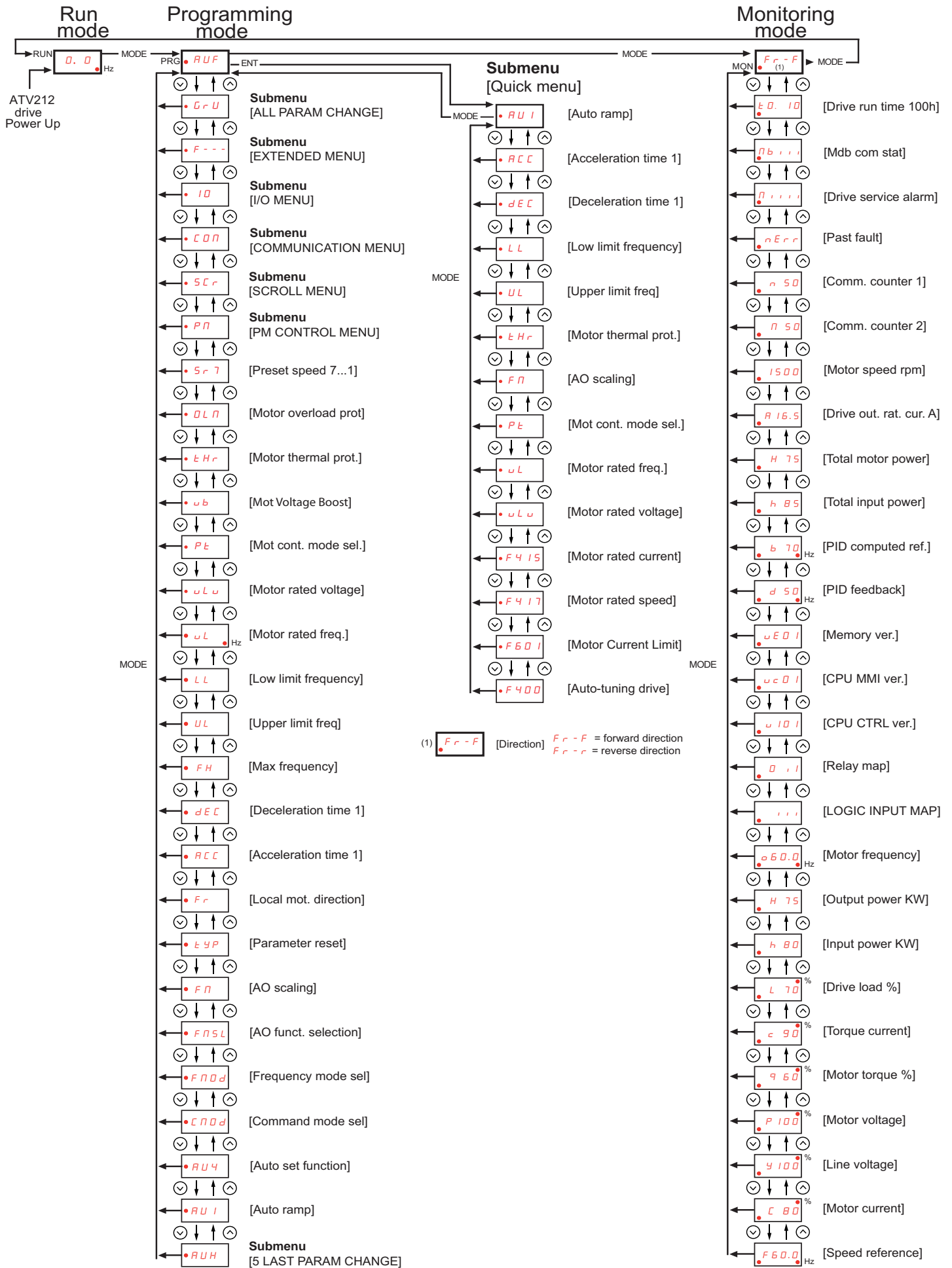

Refer to the programming manual (S1A53838) for comprehensive menu description