

WRH6606 | WRH6606S | WRH6606V

The WR Series wall mounted cabinets are built to the highest standards. More than 30 different size and door variations makes the WR Series one of the most comprehensive in the market. The fully welded frame ensures a stable structure while the key lockable quick release door opens to 180° degrees. Doors are available in Acrylic, Steel or Curved Vented.

Features

- > Fully welded frame ensures stable structure
- > Quick release door hinges
- > Reversible doors open to 180° degrees
- > Vented doors are curved with 70% perforation (protrudes 50mm)
- > 4 x Adjustable mounting rails
- > Top and bottom panel with multiple cable entry knockouts
- > Rear hinge is key lockable, can to be hinged on the left or right hand side, has multiple cable entry knockouts and 19" provisions

Standard Inclusions

- > Acrylic front door is standard (Steel and Vented doors are supplied separately)
- > 1 x Cantilever shelf (1RU 300mm deep)
- > Key lock on front door
- > Key locks on removable side panels
- > Cable entry knockouts top, bottom and rear
- > Fan vents on top
- > Front and rear 19" mounting rails with RU markings
- > Earthstud
- > 25 cage nuts and screws
- > Rear hinge



Acrylic Door – WRH6606 (Standard)



Steel Door – WRH6606S



Vented Door – WRH6606V

Part No.	RU	Height mm	Width mm	Depth mm	Colour	Door	Description
WRH6606	6RU	367	600	700	Black	Acrylic	WRH Cabinet – 6RU 600w 700d Acrylic Door
WRH6606S	6RU	367	600	700	Black	Steel	WRH Cabinet – 6RU 600w 700d Steel Door
WRH6606V	6RU	367	600	700	Black	Vented	WRH Cabinet – 6RU 600w 700d Vented Door



Acrylic Door

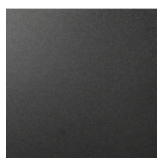

Steel Door

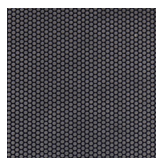

Curved Vented Door

Technical Specifications

Description: WRH Cabinet – 6RU 600w 700d

Cabinet Dimension: 367h X 600w X 700d
(Including rear hinge)

Rear Hinge Dimension: 367h X 600w X 100d

Colour: Black

Weight: 20kg

Shipping Dimension: 407h x 640w x 740d

Shipping Weight: 23kg



Removable 100mm deep rear section hinged with 19” mounting facility.

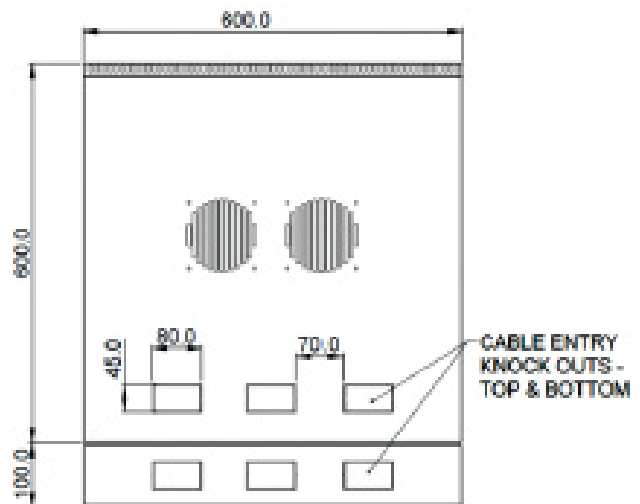
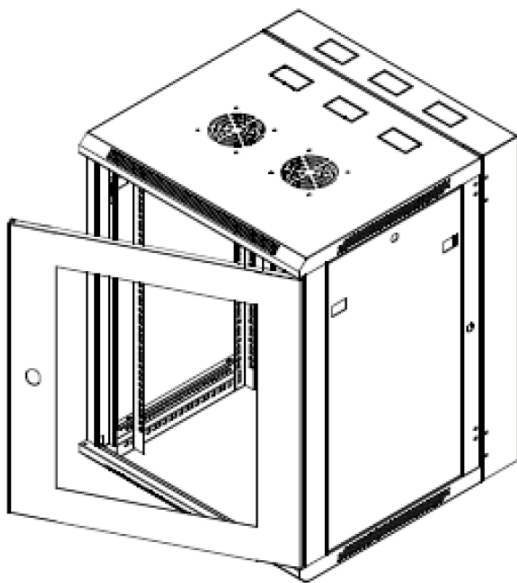

TOP VIEW - 600 DEEP WR CABINET WITH REAR HINGE BOX SECTION



Information contained in this document is accurate at the time of preparation and is provided in good faith for general guidance. The information should not be used for detailed design or final specification as it is subject to change without notice. Please contact your local Racktech sales representative or the Racktech customer support team to obtain a copy of the current technical specifications. Images are for illustration purposes only.

March 2021