

WR6418 | WR6418S | WR6418V

The WR Series wall mounted cabinets are built to the highest standards. More than 30 different size and door variations makes the WR Series one of the most comprehensive in the market. The fully welded frame ensures a stable structure while the key lockable quick release door opens to 180° degrees. Doors are available in Acrylic, Steel or Curved Vented.

Features

- › Fully welded frame ensures a stable structure
- › Quick release door hinges
- › Reversible doors open to 180° degrees
- › Vented doors are curved with 70% perforation (protrudes 50mm)
- › 4 x Adjustable mounting rails
- › Top and bottom panel with multiple cable entry knockouts
- › Removable rear panel
- › Quick Mount Rail aids mounting of cabinet

Standard Inclusions

- › Acrylic front door is standard (Steel and Vented doors are supplied separately)
- › 1 x Cantilever shelf (1RU 300mm deep)
- › Key lock on front door
- › Key locks on removable side panels
- › Cable entry knockouts top, bottom and rear
- › Fan vents on top
- › Front and rear 19" mounting rails with RU markings
- › Earthstud
- › 25 cage nuts and screws
- › Quick Mount Rail



Acrylic Door – WR6418 (Standard)



Steel Door – WR6418S



Vented Door – WR6418V

Part No.	RU	Height mm	Width mm	Depth mm	Colour	Door	Description
WR6418	18RU	897	600	450	Black	Acrylic	WR Cabinet – 18RU 600w 450d Acrylic Door
WR6418S	18RU	897	600	450	Black	Steel	WR Cabinet – 18RU 600w 450d Steel Door
WR6418V	18RU	897	600	450	Black	Vented	WR Cabinet – 18RU 600w 450d Vented Door



Acrylic Door

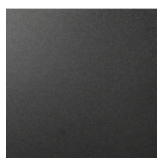

Steel Door

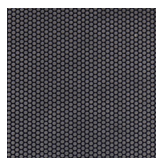

Curved Vented Door

Technical Specifications

Description: WR Cabinet – 18RU 600w 450d

Cabinet Dimension: 897h X 600w X 450d

Colour: Black

Weight: 29kg

Shipping Dimension: 937h x 640w x 490d

Shipping Weight: 32kg



Removable rear panel

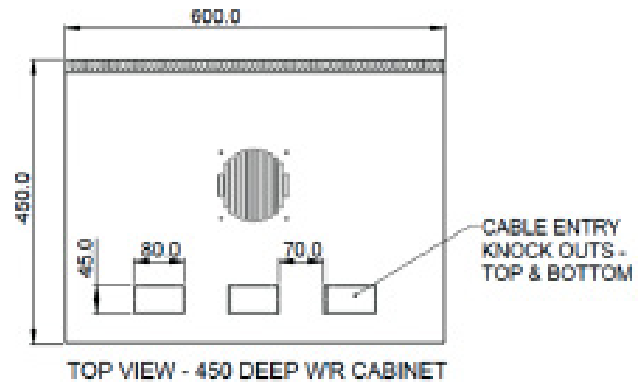
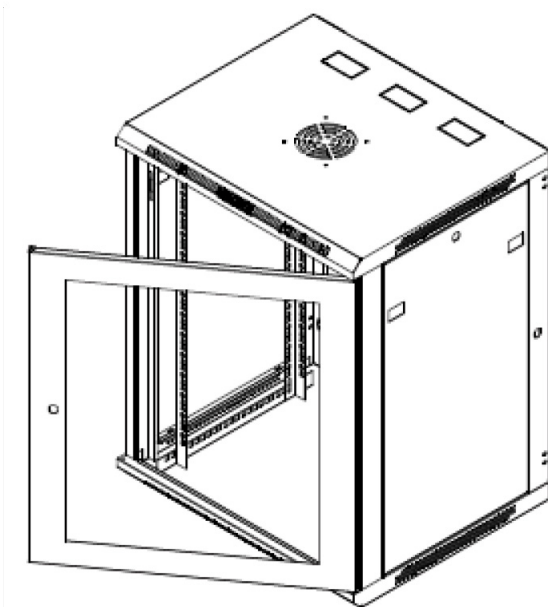

Information contained in this document is accurate at the time of preparation and is provided in good faith for general guidance. The information should not be used for detailed design or final specification as it is subject to change without notice. Please contact your local Racktech sales representative or the Racktech customer support team to obtain a copy of the current technical specifications. Images are for illustration purposes only.

March 2021