



# Industrial Switchgear

Plugs and Sockets



**Make the right choice**

Don't judge industrial switchgear by its colour

[clipsal.com](https://clipsal.com)

Life Is 

**CLIPSAL**  
by Schneider Electric



# Contents

<b>Introduction</b>	<b>5-11</b>
<b>56 Series Features</b>	<b>6</b>
<b>66 Series Features</b>	<b>8</b>
<b>WilcoROWCO</b>	<b>10</b>
<b>Application Guide</b>	
Product selector	12-13
<b>Product Catalogue</b>	
<b>Neutral</b>	<b>14-73</b>
Combination Switched Socket Outlets	14
Surface Socket Outlets	19
Switches	22
Appliance Inlets	39
Plugs	41
Extension Sockets and Appliance Connectors	45
Special Combinations and Modules	48
Mounting Enclosures (Lids & Back Boxes)	53
Adaptable Enclosures	60
Accessories and Spare Parts	67
<b>Acid</b>	<b>74-109</b>
Combination Switched Socket Outlets	74
Surface Socket Outlets	78
Switches	80
Appliance Inlets	88
Plugs	89
Extension Sockets and Appliance Connectors	92
Special Combinations and Modules	94
Mounting Enclosures (Lids & Back Boxes)	96
Adaptable Enclosures	100
Accessories and Spare Parts	103
<b>Alkaline</b>	<b>110-133</b>
Combination Switched Socket Outlets	110
Surface Socket Outlets	112
Switches	113
Plugs	115
Extension Sockets and Appliance Connectors	119
Mounting Enclosures (Lids & Back Boxes)	123
Adaptable Enclosures	126
Accessories and Spare Parts	127
<b>Heavy Duty</b>	<b>134-147</b>
Combination Switched Socket Outlets	134
Surface Socket Outlets	137
Switches	139
Appliance Inlets	142
Plugs	144
Extension Sockets and Appliance Connectors	145
Special Combinations and Modules	146
Mounting Enclosures (Back Boxes)	148
Adaptable Enclosures	149
Railway Couplers	150
Accessories and Spare Parts	151
<b>Technical Guide</b>	
Chemical Resistance Guide	152-153
Industrial Application Matrix	154-158
International Protection Ratings	159



# Introduction

## The Power Behind Today's Industry

Designed to satisfy customer needs, precisely engineered and carefully manufactured, Clipsal Industrial Switchgear is as versatile as your requirements. Industrial switchgear, being one of the most important components of industry, must be tough, and perform under many adverse conditions.

Clipsal's Industrial Switchgear range, comprising of 56 Series, 66 Series and Wilco Ranges, satisfies these challenges with the use of durable engineering plastics and cast metal and in most instances have been tested for protection against ingress of water and dust to International Protection Rating IP66. It is testimony to the excellence in both manufacture and performance of Clipsal Industrial Switchgear.

## Operation

For safety's sake all of the switches in the Clipsal Industrial Switchgear ranges have been equipped with facilities for double pad-locking. When plugs are removed, the socket flap automatically locks into place, resisting dust or water from entering.

## Standards

Pin configurations for plugs, sockets and switched socket outlets comply with AS/NZS3123 and switches with appropriate parts of AS/NZS3947.3 & AS/NZS3133.

## Temperature Resistance

The temperature range of the 56 & 66 Series and Wilco products are limited by two aspects;

- 1) the material used in mouldings and castings
- 2) the operating temperature of the internal electrical components.

The material type limits the use of the 56 & 66 Series standard product to -25°C to +75°C. All materials used for the Wilco ranges are tested to operate in extreme temperatures from -20°C to +60°C ambient.

## Transparent Plastic Materials

The introduction of transparent materials to the 56 and 66 Series ranges enables the inspection and checking of the components pin/socket configuration and wiring at a glance, while still providing protection against the elements.

## Designed to Mix and Match

What suits one industry might not be the best match for another. That's why the 56 Series and WilcoROWCO\* ranges were specifically designed to mix and match. There is an extensive choice of modules available, including switches, sockets, and residual current devices. Clipsal mounting enclosures range in size from 1 to 4 for WilcoROWCO and 1 to 16 gang for 56 Series.

This allows assemblies to be customised - from a simple switch station to a large electrical control panel. Accessories can be ordered Less Enclosure (back box) by simply specifying LE after the 56 Series catalogue number or /LE after specific WilcoROWCO catalogue numbers.

\*from 10A to 32A

## 56 Series Features

### Switches, sockets, or combination switch sockets features and benefits

1. One- and two-piece cover options; one-piece improves water resistance in wash-down areas and two-piece is ideal for economical changeovers
2. Large switch handle simplifies operation with gloves
3. Contoured profile — reduces potential dirt build-up areas
4. Increased padlocking area — more flexibility when locking off
5. Solid cover, (no pivot bungs or holes) to add strength to flap and resist water/dust entry
6. Patented rigid gasket design provides IP66 even without cover screw caps; gasket won't flex or pinch under cover
7. LED kit option — ideal to monitor phase conditions without the need to remove covers
8. Switch-knob padlock hole locations below horizontal reduces dust entering and seizing switch-knob
9. Knob Bearing improves switch life, endurance, smoothness of actuation and resists switch seizure
10. Clearances between switch cover & knob allow for any dust ingress to come out, resisting switch knob seizure
11. Wide opening hinged flap to assist with plug insertion/removal — without allowing dust or water ingress
12. Permanent laser markings eliminate stickers falling off into food or beverages
13. Co-injected socket gasket — avoids shrinkage in harsh environments

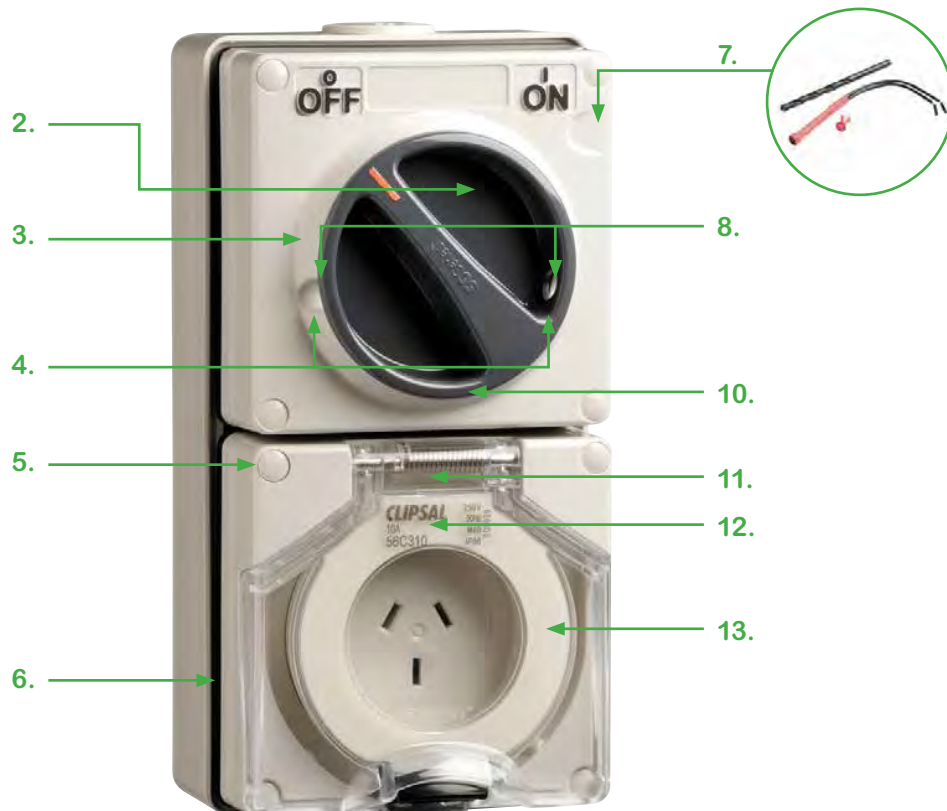

## Plugs and plug sockets features and benefits

1. Less parts, more efficiency
2. Separate adaptor available for SWA, corrugated, or hose fittings provides full protection of cabling to end of plug
3. Patented Mactro snap-shut body
  - Fast access — ideal during breakdowns
  - No screws — removes stress points
4. Improved body shape — ergonomic hand placement
5. Unique cable clamp provides simplified sealing around cable, avoiding fiddly onion ring approach
6. Wide lock ring for simple operation whilst wearing gloves
7. Shallow grooves on lock ring and cable clamp reduce potential for dirt being trapped and improves hygiene

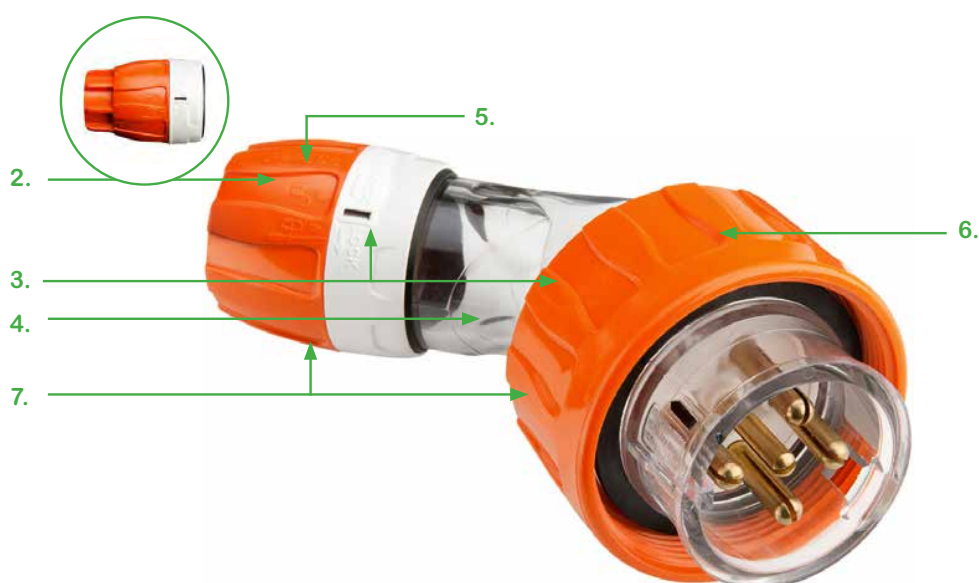

## Snap shut bodies

Screw-less assembly using a 'latching' spring allows for speed, simplicity, product strength and improved reliability. The 'latching' spring clip stays down once it is pressed, so it is just a simple 'press and switch'. The spring clip, when shut, does not exert any stress on the housings, resulting in a stronger body and sleeve connection.



### To Open

1. Look for padlock and arrow icons
2. Align grey band to locked position
3. Insert driver and push down firmly
4. Align grey band to unlocked position
5. Twist body left only



### To Close

1. Look for padlock and arrow icons
2. Align grey band to unlocked position
3. Insert driver and push down firmly
4. Align grey band to locked position
5. Twist body right only

## 66 Series Features

### Make light work of installations with 66 Series Combination Switched Socket Outlets

Clipsal design, engineering and precision brings you the revolutionary 66 Series of Combination Switched Socket Outlets and Plugs for 50 and 63 amp, 4, 5 or 7 pin heavy-duty appliances, such as welders, pumps, and mobile conveyors.

Until recently 50 and 63 amp socket outlets and plugs were constructed with metal clad housings, which, in many situations, encounter drawbacks with their heavyweight, time consuming installation and susceptibility to corrosion.

66 Series Switched Socket Outlets and Plugs solve these problems and offer many other additional benefits.

Major features of the 66CV Switched Socket Outlets are their robust PVC back box and polyester cover that provide excellent chemical and high impact resistance as well as UV stability, in a neat, compact unit that's quicker and easier to install. 66P Plugs are manufactured from fully moulded, transparent polycarbonate or resistant orange polyester to offer the same degree of strength and resistance to chemicals and UV rays.

For convenience both the switched socket outlets and plugs can be easily used with gloved hands.

An internal interlock is fitted to the outlet to help prevent insertion or withdrawal of the plug (provided the plug is fitted with an interlock facility) while the switch is in the 'on' position.

66CV Series Combination Switched Socket Outlets also incorporate a padlock facility in the 'off' position for added security.



### Features

- IP66 protection in accordance with AS 1939 for the Combination Switched Socket Outlet and also when engaged with a plug.
- Separate back box with rear wiring facility for easy installation of large diameter cables.
- 1 x M40 entry (top) and 2 x M32 entries (bottom) to assist cable termination.
- Large switch knob and socket outlet flap for easy operation even with gloved hand.
- Socket outlet flap includes a heavy spring assembly to ensure IP66 integrity.
- Configurations of sockets and keyways in accordance with AS/NZS 3123.
- Stainless steel, combination head, captive cover screws for corrosion resistance and easy installation.
- Switch rated for motor duty, AC23 in accordance with AS/NZS 3947.3.
- Standard colour - Grey. Resistant Orange optional. Double insulated.
- Interior assembly is completely removable to assist with cable entry and termination of the large conductors required for the unit.



### Plugs and plug sockets features and benefits

1. Clear pin surround provides quick and reliable location of plug in socket and protection of pins.
2. Wide Lock Ring can be tightened and unscrewed with ease, even with a gloved hand. Provides positive sealing with an inbuilt sponge-type gasket.
3. Sturdy Terminal Housing for durability and years of service.
4. Stainless Steel Combination Head Screws for corrosion resistance and easy installation.
5. Transparent Polycarbonate Body allows instant inspection of connections.
6. Internal Cable Clamp is fast fixing and grips two ways, helping to resist cable twisting.
7. Cable Gland is extremely flexible with positive grip to help ensure dependable sealing.
8. Gland Nut with 50mm threaded cable entry for alternative facility termination.

IP Ratings only apply to cable terminations as per wiring instructions.

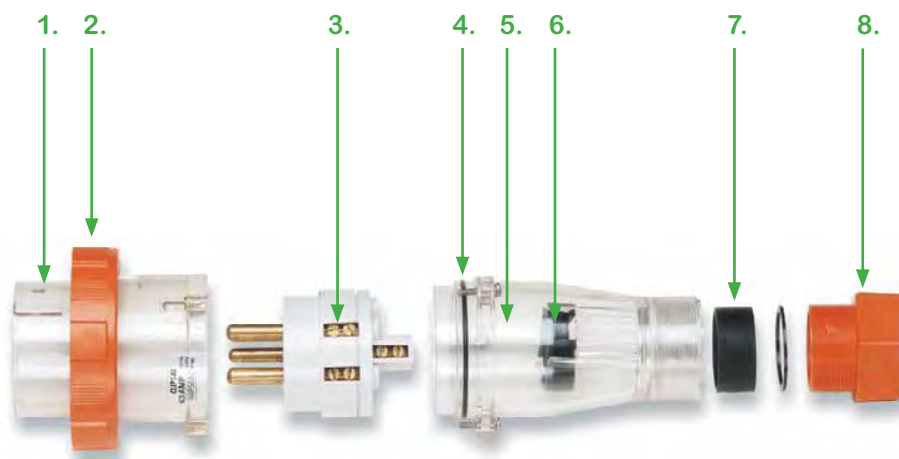

### Plug configurations

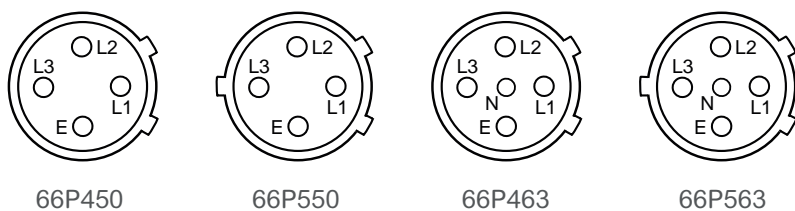

## WilcoROWCO

WilcoROWCO Industrial Switchgear is precisely engineered and carefully manufactured to satisfy customer needs and provide versatile solutions to meet any requirements.

Industrial switchgear, being one of the most important components of industry, has to be tough, able to take hard knocks and give dependable performance under many adverse conditions.

WilcoROWCO Metal Clad satisfies these challenges and more with the use of maximum strength die cast aluminium and has been tested for protection against the ingress of water and dust to up to International Protection Rating IP66.



### Applications

Heavy Industrial environments both indoors and outdoors where protection from dust, water, UV and impact is needed.

### Features

- Heavy duty cast aluminium.
- IP66 rated to IEC60529.
- Internal non-accessible and external accessible-mounting facilities.
- Stainless steel (316 grade) cover mounting screws metric thread stainless steel screws also come standard with the Metal Clad range. They are treated to help resist chemical reaction with the aluminium body, offering superior corrosion resistant properties.
- Can be padlocked off at two locations. The two padlock positions accept 8mm hasp padlocks or scissor lockout tags.

Make the right choice, don't judge industrial switchgear by its colour

No economical plastic material is available to provide maximum impact strength as well as a high degree of chemical resistance. The various products that make up the Clipsal Industrial Switchgear range therefore have been designed specifically in different materials to withstand light, medium and heavy industry applications. In fact, Clipsal 56 Series is the only product of its type that provides UV and IP resistance, along with resistance to general chemicals or neutrals, acids and alkalines. The 56 Series range is complemented by the WilcoROWCO cast metal range that provides 'heavy duty' resistance particularly against impact.

To make the right choice, the following table can be used as a guide when selecting the right material for your application.

				
<b>Range and resistance suitability</b>	56 Series Grey (GY) General industrial uses, <b>Neutral</b> chemicals	56 Series Chemical Resistant Orange (RO) & Chemical Resistant White (RW). Resistance to <b>Acid</b> -based detergents & chemicals	56 Series Chemical Resistant Grey (CG) & Chemical Resistant Dark Grey (WW). Resistance to <b>Alkaline</b> -based chemicals/foaming caustic	WilcoROWCO Metal Clad Cast Aluminium. Toughness for high impact & <b>Heavy Duty</b> environments
<b>Chemical resistance</b>				
<b>Symbol</b>				

The following pages will provide a more detailed guide outlining typical applications for the ranges outlined above. This is to be used in conjunction with the Technical Guide and International Protection charts in the rear of the book.

# Application Guide

## Make the right choice

the table below is to be used as a guide when establishing which Clipsal Industrial product is best suited for specific environments. It takes into consideration the materials that Clipsal's Industrial range is made from and anticipates what it will be exposed to in various applications. For further information please contact your Clipsal and Schneider Electric representative.

Product Selector				
Application	Environment	Best	Better	Good
Maintenance workshop	Indoors, ambient air temperature, low UV levels, cutting fluids, oils, no or minimal exposure to rain.	Neutral	Acid	Heavy Duty
Tool room or general fabrication workshop	Indoors, ambient air temperature, low UV levels, cutting fluids, oils.	Neutral	Acid	Heavy Duty
Plant rooms	Indoors, 0 °C to 40 °C, low UV levels, possible moisture/condensation, no or limited chemicals or detergent exposure.	Neutral	Acid	Heavy Duty
Pedestrian traffic areas	Indoors or outdoors, ambient air temperature, outdoors may be subjected to high UV levels and rainfall, indoors low UV and moisture, no or minimal chemicals or detergent exposure. May be prone to vandalism.	Neutral	Acid	Heavy Duty
Staff lunchroom	Indoors, 0 °C to 40 °C, low UV levels, some exposure to water, mild detergents or household cleaners. No or minimal exposure to rain. No alkaline cleaners.	Acid	Neutral	Alkaline
Public eating area	Indoors or outdoors, ambient air temperature, outdoors may be subjected to high UV levels and rainfall, indoors low UV and moisture, some exposure to water, mild detergents or household cleaners. No alkaline cleaners.	Heavy Duty	Neutral	Acid
Cool room for perishable storage	Indoors, -10 °C to 15 °C, low UV levels, possible moisture or condensation, no or minimal chemicals or detergent exposure, no or minimal exposure to rain.	Neutral	Acid	Heavy Duty
Warehouse	Indoors, ambient air temperature, low UV levels, no exposure to rain, possible impacts from handling equipment. No or minimal exposure to rain.	Neutral	Acid	Heavy Duty
Assembly plant or fabrication area	Indoors, ambient air temperature, low UV levels, no exposure to rain, possible impacts from handling equipment. No or minimal exposure to rain.	Neutral	Acid	Heavy Duty
Alkali's washdown area (boning rooms, food processing area)	Indoors, 5 °C to 25 °C, low UV levels, foaming alkaline cleaners, 75 °C high pressure cleaners, prone to condensation.	Alkaline		
Detergent washdown (fast food preparation)	Indoors, 5 °C to 25 °C, low UV levels, mild detergents or mild household cleaners, washdown with water, prone to condensation.	Alkaline	Neutral	Acid
Acids or citrus based cleaners (wineries, breweries, coal wash plant)	Indoors or outdoors, ambient temperature of -5 °C to 70 °C, low to high UV levels, acidic chemicals or products, possible exposure to citrus cleaners, washdown with water, no to high exposure to rain or water. No alkaline chemicals or cleaning agents.	Acid		
Bottle or vat sterilising	Indoors, 5 °C to 40 °C, low UV levels, exposure to detergents or sterilising agents, washdown with water, prone to condensation.	Alkaline		
Exposure to cooking Oil (chip friers etc.)	Indoors, 5 °C to 40 °C, low UV levels, exposure to cooking oils, exposure to detergents or alkali cleaners, washdown with water, prone to condensation. No acid based cleaning agents	Alkaline		

## Product Selector

Application	Environment	Best	Better	Good
Minerals processing or Furnaces	Indoors, 0 °C to 75 °C, low UV levels, No or minimal exposure to moisture, possible heavy impacts from handling equipment.			
Outdoor storage tanks or ponds or silos	Outdoors, ambient air temperature -15 °C to 75 °C. High UV, possible exposure to acidic chemicals or chlorine, direct exposure to rain. Not DIP or EX.			
Despatch or vehicle loading or transport area	Indoors/outdoors, ambient air temperature, low to high UV levels, no to high exposure to rain, possible impacts from handling equipment.			
Staff or public car park	Indoors or outdoors, ambient air temperature, low to high UV levels, no to high exposure to rain, may be prone to vandalism.			
Toilets/wet areas	Indoors, 5 °C to 40 °C, low UV levels, exposure to detergents or alkali cleaners, washdown with water, prone to condensation. No acid based cleaning agents.			
Office	Indoors, 0 °C to 40 °C , low UV levels, minimal moisture or condensation, no or limited chemicals or detergent exposure.			
Food preparation area or kitchen	Indoors, 5 °C to 25 °C, low UV levels, mild detergents, citrus based or household cleaners, washdown with water, prone to condensation. No alkaline cleaners.			
Rooftop plant platforms	Outdoors, ambient air temperature -15 °C to 75 °C. High UV, direct exposure to rain.			
Bottling plant	Indoors, ambient air temperature, low UV levels, no exposure to rain , possible impacts from handling equipment. No or minimal exposure to rain.			
Swimming pool or growing pond	Indoors/outdoors, ambient air temperature -10 °C to 50 °C, low to high UV levels, no to high exposure to rain, may be prone to vandalism, presence of chlorine.			
Boat washdown	Outdoors, ambient air temperature -15 °C to 75 °C. High UV, direct exposure to rain, exposure to salt water.			
Conveyor belt	Indoors or outdoors, ambient air temperature, low to high UV levels, no to high exposure to rain, may be exposed to impacts. Not DIP or EX.			
Outdoor BBQ's	Outdoors, ambient air temperature -15 °C to 75 °C. High UV, possible exposure to animal fats or cooking oil splash, direct exposure to rain. May be prone to vandalism.			
Outdoor lighting	Outdoors, ambient air temperature -15 °C to 75 °C. High UV, direct exposure to rain. May be prone to vandalism.			



# Heavy Duty



The Heavy Duty range of Clipsal Industrial products are suited for environments that are dusty or clean, wet or dry, Indoors or outdoors (UV resistant), heavy impact areas, vandal prone areas.

Some typical applications include: Foundries, furnaces, power generation & distribution, cement plants, quarries, open cut mines, heavy transport sectors, welding outlets, jails, public areas. If Clipsal Industrial products are part of the 'heavy duty' range they will easily be identified by a black circle with Heavy Duty text and/or by a black circle with a white truck symbol as shown below.



AND/OR



The Heavy Duty range encompasses Clipsal WilcoROWCO and Wilco Metal range. The following section showcases these products in more detail.

## Combination Switched Socket Outlets

The Clipsal wilcoROWCO Metal Clad combination switched sockets have a modular 99 x 201 mm design that allows installers to mix and match covers on to two, three, or four, gang enclosures (bases). The one piece cover also means there are less access points for dust or water to penetrate. Although there are other switches in the wilcoROWCO offer (50 A and 63 A), this modular range is only available from 240 V, 10 A to 415 V, 32 A. The ON and OFF positions are clearly marked with raised lettering so they will never wear off.

A provision for a 8 mm padlock is provided for locking OFF. If locking is required in ON position, simply drill a hole where necessary. An optional interlocking facility is available with special orders, which can prevent three phase plugs being removed when switch is ON and prevents the switch being turned ON without a plug being inserted.

The Wilco range of combination fused switches and socket outlets are available in 4 and 5 pin socket configurations up to 200 A. They feature a 3 mm sheet steel case with cast aluminium covers.

The switch design uses 'M' Clip 'Knife Blade' type contacts capable of withstanding high fault currents.

The compression spring on the switch carriage is designed to provide quick make and quick break action for the contacts.

A cover interlock is provided to prevent the opening of the cover with the switch in the 'ON' position or closed with the cover open.

### 1 Piece Cover



## Heavy Duty - Clipsal 56 Series

Catalogue Number	No. of Switch Poles	I <sub>the</sub> (Amp)	Ui / Ue (Volt)	Ie (A) Utilisation Category		Type of Socket	Cond. Term Size (mm)	O/A Dimensions			Matching Plug	Socket Config
				AC21A	AC23A			Min	Max / Cond.	(H)		
WMC310	1P	10	250	10	11	1P+N	[1,5,6]	239	99	116	56P310	A
WMC310/LE	1P	10	250	10	11	1P+N	[1,5,6]	239	99	49	56P310	A
WMC310D	2P	10	250	10	11	1P+N	[1,5,6]	239	99	116	56P310	A
WMC310L	1P	10	250	10	11	1P+N	[1,5,6]	239	99	116	56P310L	C
WMC310LD	2P	10	250	10	11	1P+N	[1,5,6]	239	99	116	56P310L	C
WMC315	1P	15	250	15	11	1P+N	[1,5,6]	239	99	116	56P315	B
WMC315/LE	1P	15	250	15	11	1P+N	[1,5,6]	239	99	49	56P315	B
WMC315D	2P	15	250	15	11	1P+N	[1,5,6]	239	99	116	56P315	B
WMC320	1P	20	250	20	21	1P+N	[2,5,6]	239	99	116	56P320	H
WMC332	1P	32	250	32	28	1P+N	[4,16]	239	99	116	56P332	I
WMC410	1P	10	500	10	11	3P+E	[1,5,6]	239	99	116	56P410	K
WMC420	1P	20	500	20	21	3P+E	[2,5,6]	239	99	116	56P420	L
WMC432	1P	32	500	32	28	3P+E	[4,16]	239	99	116	56P432	N
WMC450	1P	50	500	50	40	3P+E	[10,16]	370	155	185	66P450	A1
WMC463	1P	63	500	63	50	3P+E	[16,25]	370	155	185	66P463	A3
WMC510	1P	10	500	10	11	3P+N+E	[1,5,6]	239	99	116	56P510	Q
WMC520	1P	20	500	20	21	3P+N+E	[2,5,6]	239	99	116	56P520	R
WMC520/LE	1P	20	500	20	21	3P+N+E	[2,5,6]	239	99	49	56P520	R
WMC532	1P	32	500	32	28	3P+N+E	[4,16]	239	99	116	56P532	S
WMC532/LE	1P	32	500	32	28	3P+N+E	[4,16]	239	99	49	56P532	S
WMC550	1P	50	500	50	40	3P+N+E	[10,16]	370	155	185	66P550	A2
WMC563	1P	63	500	63	50	3P+N+E	[16,25]	370	155	185	66P563	A4

## Fused



Dimensions (mm)

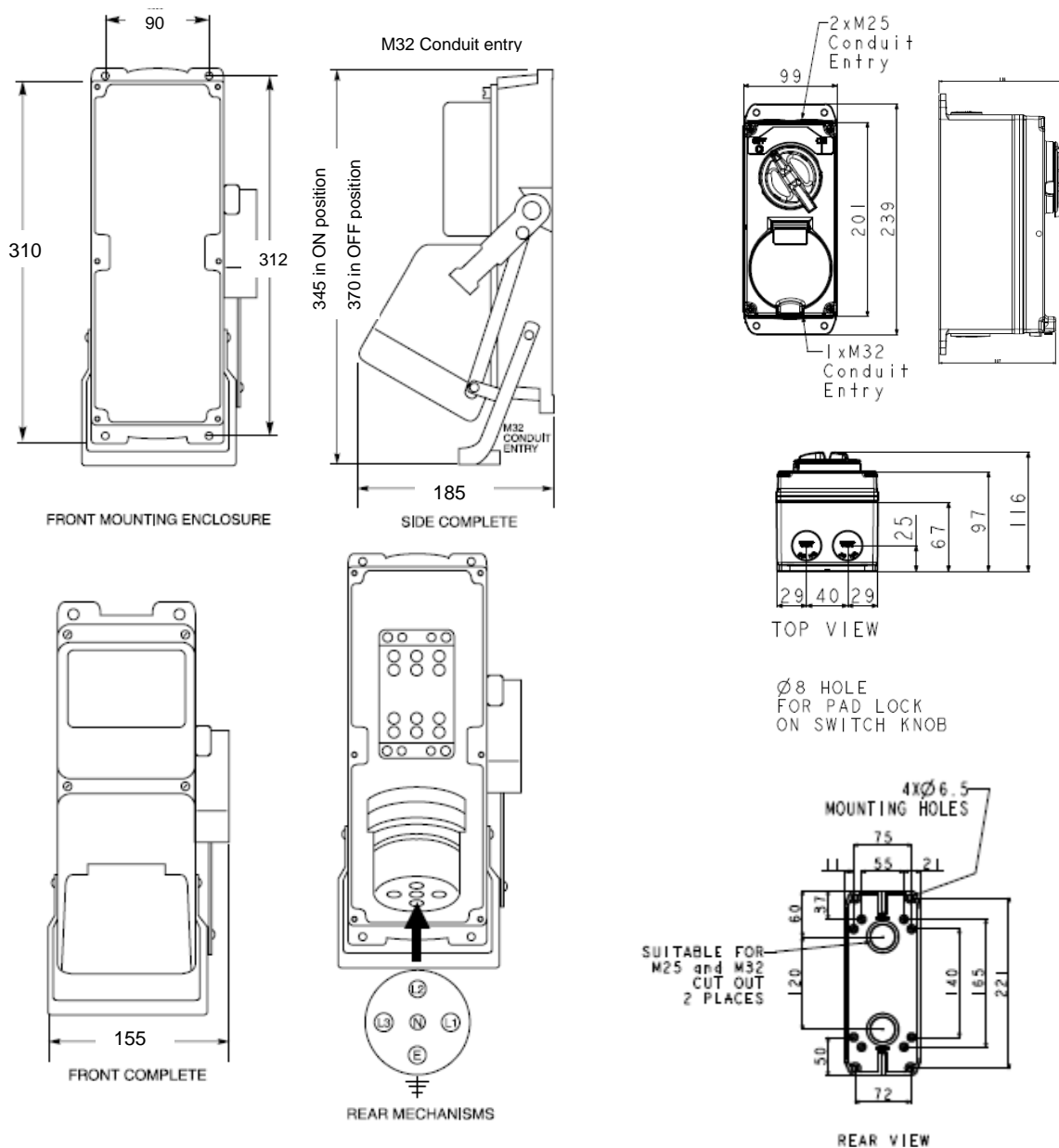

Heavy Duty - Clipsal 56 Series

Catalogue Number	No. of Switch Poles	I <sub>the</sub> (Amp)	Ui / Ue (Volt)	Ie (A) Utilisation Category	O/A Dimensions			Matching Plug	Socket Config	Drawing Number
					(H)	(W)	(D)			
					AC22A					
WCFSP4100-EC	3P	100	415 - 440	-	622	394	289	P4100	46	2
WCFSP5100-EC	3P	100	415 - 440	-	622	394	289	P5100	48	2
WCFSP5160-EC	3P	160	415 - 440	-	622	394	289	P5160	52	2
WCFSP563-EC	3P	63	415 - 440	63	362	300	203	WMP563	90	1
WCFSP463	3P	63	415 - 440	63	362	300	203	E463P	88	1



## Surface Socket Outlets

Clipsal wilcoROWCO Metal Clad socket outlets 240 V, 10 A to 415 V, 32 A have a modular 99 x 99 mm design that allows installers to mix and match socket covers on to one, two, three, or four gang enclosures (bases).

The protective socket flap is spring loaded for less chance for water or dust ingress if operators forget to close the flap. This is further enhanced with a flap retention latch.

Clipsal wilcoROWCO Metal Clad 63 A socket outlets are the largest sockets in the metal clad range. They have larger bases and covers to cater for additional wiring space. The protective socket flap is spring loaded for less chance for water or dust ingress if operators forget to close the flap. This range is the first choice when sockets for higher amperages are required.

External mounting and easy installation is provided to suit a variety of fixing devices and fasteners.

The Wilco WB sockets offer a range of alternative sockets for applications from 63 A to 160 A.

The 63 A version is manufactured from cast iron and the 100 A to 160 A products are manufactured from aluminium.



WMB310

WMB563



WB5160

### Heavy Duty - Clipsal 56 Series

Catalogue Number	I <sub>the</sub> (Amp)	U <sub>i</sub> / U <sub>e</sub> (Volt)	Type of Socket	Cond. Term Size (mm)		O/A Dimensions			Matching Plug	Socket Config
				Min	Max / Cond.	(H)	(W)	(D)		
WMB210	10	250	1P + N	[1.5,6]		137	99	107	56P210	D
WMB215/32	15	32	1P + N	[1.5,6]		137	99	107	56P215/32	E
WMB310	10	250	1P + N + E	[1.5,6]		137	99	107	56P310	A
WMB310/LE	10	250	1P + N + E	[1.5,6]		137	99	40	56P310	A
WMB310L	10	250	1P + N + E	[1.5,6]		137	99	107	56P310L	C
WMB315	15	250	1P + N + E	[1.5,6]		137	99	107	56P315	B
WMB315/LE	15	250	1P + N + E	[1.5,6]		137	99	40	56P315	B
WMB320	20	250	1P + N + E	[2.5,6]		137	99	107	56P320	H
WMB332	32	250	1P + N + E	[6,16]		137	99	107	56P332	I
WMB410	10	500	3P + E	[1.5,6]		137	99	107	56P410	K
WMB420	20	500	3P + E	[2.5,6]		137	99	107	56P420	L
WMB432	32	500	3P + E	[4,16]		137	99	107	56P432	N
WMB463	63	500	3P + E	[10,25]		183	115	182	66P463	A3
WMB510	10	500	3P + N + E	[1.5,6]		137	99	107	56P510	Q
WMB520	20	500	3P + N + E	[2.5,6]		137	99	107	56P520	R
WMB520/LE	20	500	3P + N + E	[2.5,6]		137	99	40	56P520	R
WMB532	32	500	3P + N + E	[4,16]		137	99	107	56P532	S
WMB532/LE	32	500	3P + N + E	[4,16]		137	99	40	56P532	S
WMB563	63	500	3P + N + E	[10,25]		183	115	182	66P563	A4
WMB720	20	500	3P + N + E	[2.5,6/2.5]		137	99	107	56P720	X
WB5100	100	500	3P + N + E	-		475	168	315	P5100	48
WB5160	160	500	3P + N + E	-		475	168	315	P5160	52
WB563	63	500 V	3P + N + E	-		203	118	178	WMP563	116

Dimensions (mm)

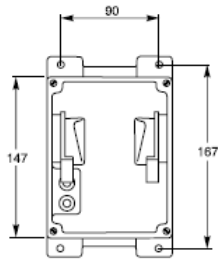

FRONT MOUNTING ENCLOSURE

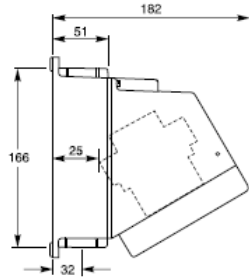

SIDE COMPLETE

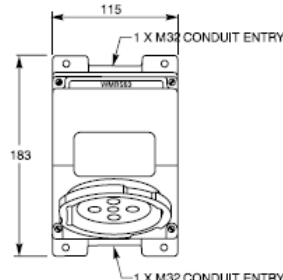

FRONT COMPLETE

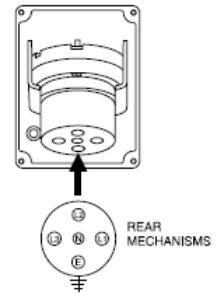

REAR MECHANISMS

**WMB463**  
**WMB563**

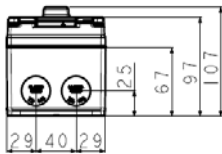

TOP VIEW

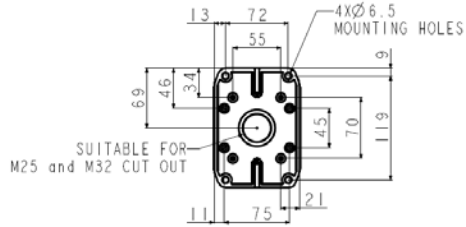

REAR VIEW

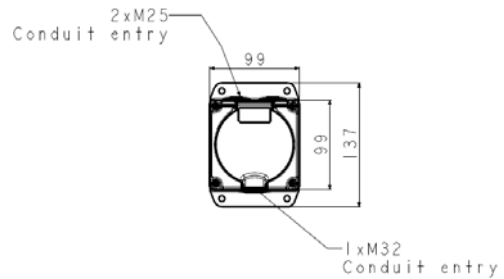

FRONT VIEW

# Switches

## Surface Switches

The Clipsal wilcoROWCO Metal Clad switches have a robust design that allows installers to install switches in extremely tough environments. The wilcoROWCO offer is available in more compact modular enclosures, (10 A to 32 A) and in two larger size enclosures (238 x 120 mm or 380 x 170 mm) to ensure there is ample cable space for larger wiring applications.

Additionally 3, 4, 6, and 7 pole switches suit 415 V in current ratings ranging from 20 A to 125 A. A provision for a 8 mm padlock is provided for locking OFF. If locking is required in ON position, simply drill a hole where necessary.

The Clipsal wilcoROWCO Metal Clad with a modular 99 mm<sup>2</sup> design allows installers to mix and match switch covers on to one, two, three, or 4 gang enclosures (bases). This modular range is available from 240 V, 10 A to 415 V, 32 A.

All switches incorporate a positive rotary switch action and a provision in the switch knob for a 8 mm padlock is also provided for locking OFF. If locking is required in ON position, simply drill a hole where necessary.

The ON and OFF positions are clearly marked with raised lettering so they will never wear off.

Less Enclosure versions are indicated with letters LE in the reference.



WMS320



WMS380

## Heavy Duty - Clipsal 56 Series

Catalogue Number	No. of Switched Poles	I <sub>the</sub> (Amp)	U <sub>i</sub> / U <sub>e</sub> (Volt)	I <sub>e</sub> (A) Utilisation Category		Cond. Term Size (mm)		O/A Dimensions.		
				AC21A	AC23A	Min	Max / Cond.	(H)	(W)	(D)
WMS110	1P	10	250	10	11	[2.5,16]		137	99	123
WMS110/LE	1P	10	250	10	11	[2.5,16]		137	99	55
WMS110-DP	1P	10	250	10	11	[2.5,16]		137	99	123
WMS110-TW	1P	10	250	10	11	[2.5,16]		137	99	123
WMS116	1P	16	250	16	15	[2.5,16]		137	99	123
WMS120	1P	20	250	20	21	[2.5,16]		137	99	123
WMS120/LE	1P	20	250	20	21	[2.5,16]		137	99	55
WMS120-TW	1P	20	250	20	21	[2.5,16]		137	99	123
WMS210	2P	10	250	10	11	[2.5,16]		137	99	123
WMS210/LE	2P	10	250	10	11	[2.5,16]		137	99	55
WMS310	3P	10	500	10	11	[2.5,16]		137	99	123
WMS320	3P	20	500	20	21	[2.5,16]		137	99	123
WMS320/LE	3P	20	500	20	21	[2.5,16]		137	99	55
WMS332	3P	32	500	32	21	[4,16]		137	99	123
WMS332/LE	3P	32	500	32	21	[4,16]		137	99	55
WMS340	3P	40	500	40	28	[2.5,16]		238	120	123
WMS350	3P	50	500	50	28	[4,16]		238	120	123
WMS363	3P	63	500	63	40	[4,16]		238	120	123
WMS380	3P	80	500	80	55	[16,25]		380	170	123
WMS3100	3P	100	500	100	66	[2.5,16]		380	170	123
WMS3125	3P	125	500	125	66	[2.5,16]		380	170	123
WMS420	3P	20	500	20	21	[2.5,16]		137	99	123
WMS432	3P	32	500	32	21	[2.5,16]		137	99	123
WMS432/LE	3P	32	500	32	21	[2.5,16]		137	99	55
WMS440	3P	40	500	40	28	[6,35]		238	120	123
WMS450	3P	50	500	50	28	[10,25]		238	120	123
WMS463	3P	63	500	63	28	[10,25]		238	120	123
WMS480	3P	80	500	80	55	[10,25]		380	170	123
WMS620	3P	20	500	20	21	[2.5,10]		238	120	123
WMS663	3P	63	500	63	40	[10,25]		380	170	123
WMS732	3P	32	500	32	21	[4,10]		238	120	123

## Changeover and Reversing Switches

Designed to give full motor control in a unit that is rated IP66. Clipsal wilcoROWCO Changeover and Reversing Switches are housed within single modules as part of the overall modular concept of the range.

Earth and neutral connectors accommodating 3 x 6 mm<sup>2</sup> cables are provided with all models.

Option available 7 Series Cam Type Switch Mechanisms are used and therefore special configurations are available. Contact your Schneider Electric representative for more information.



### Dimensions (mm)

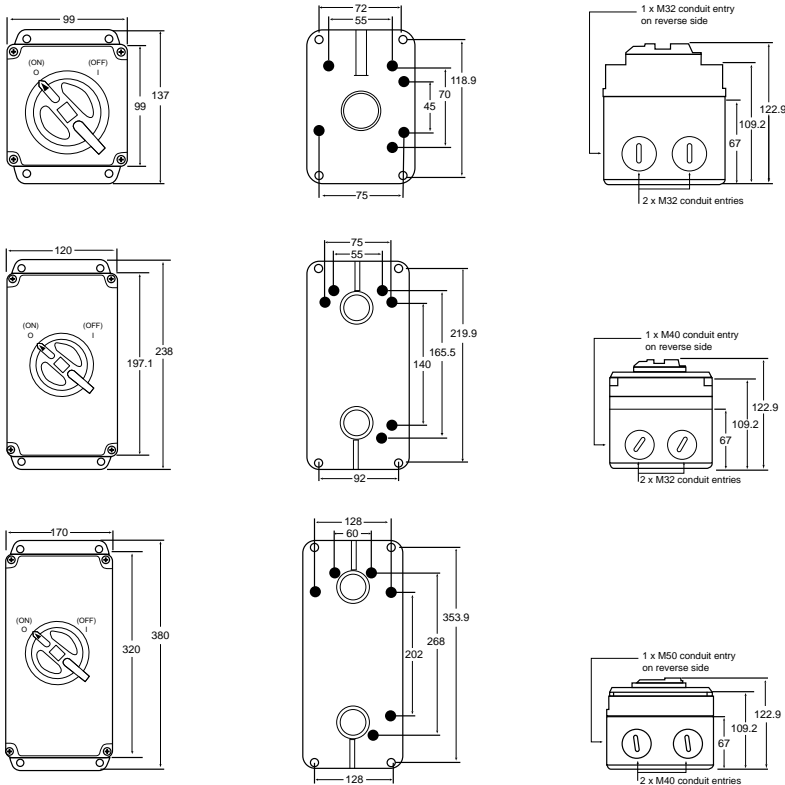

Changeover Switches  
WMS432CO

Isolator Switches  
WMS340  
WMS350  
WMS363  
WMS440  
WMS450  
WMS463  
WMS620  
WMS632  
WMS732

Changeover Switches  
WMS363CO

Reverse Switches  
WMS363R

Isolator Switches  
WMS380  
WMS3100  
WMS3125  
WMS480  
WMS663

### Heavy Duty - Clipsal 56 Series

Catalogue Number	No. of Switched Poles	I <sub>the</sub> (Amp)	Ui / Ue (Volt)	Ie (A) Utilisation Category		Cond. Term Size (mm)	O/A Dimensions		
				AC21A	AC23A		Min	Max	Cond.
WMS120CO	1P	20	250	20	21	[2,5,16]	137	99	123
WMS132CO	1P	32	250	32	28	[1,5,6]	137	99	123
WMS320CO	3P	20	500	20	21	[2,5,16]	137	99	123
WMS332CO	3P	32	500	32	21	[4,16]	137	99	123
WMS363CO	3P	63	500	63	40	[10,25]	380	170	123
WMS432CO	3P	32	500	32	21	[2,5,16]	238	120	123
WMS320R	3P	20	500	20	21	[2,5,16]	137	99	123
WMS332R	3P	32	500	32	21	[4,16]	137	99	123
WMS363R	3P	63	500	63	40	[10,25]	380	170	123

## Push Button Control Stations

The wilcoROWCO Metal Clad Push Button Control Stations are available with Stop, Emergency Stop Mushroom Head and Start control. The modular 99 mm<sup>2</sup> design allows installers to mix and match switch covers on to one, two, three, or four gang enclosures (bases).

All control stations utilise Schneider Harmony push buttons to ensure consistency and reliable operation.

The stations are ideal in wet, dusty, or dirty conditions for controlling motor starters on pumps, saws, compressors, lathes, and processing lines.

### Features

- Heavy duty cast aluminium
- Start - High visibility yellow enclosure with Ø22 mm green push button
- Stop - High visibility yellow enclosure with Ø22 mm red push button
- Emergency Stop - High visibility enclosure with Ø39 mm mushroom head latching PB
- IP66 rated to IEC60529
- External and accessible mounting facilities
- Stainless steel (316 grade) cover mounting screws



WMPB1ST



WMPB1SPML

## Heavy Duty - Clipsal 56 Series

Catalogue Number	Push Button Type	Type of Contacts	Rated Thermal Current I <sub>th</sub> (Amp)	Rated Insulation Voltage U <sub>i</sub>	I <sub>e</sub> AC15 (Amp)			U <sub>i</sub> / U <sub>e</sub> (Volt)	Short Circuit Protection	Cond. Term Size (mm)	O/A Dimensions		
					110 V	240 V	415 V				Min	Max / Cond.	(H)
WMPB1SP	Momentary contact stop	NC	10	600 ~	6	3	1.2	500	10A with gL type fuse	2 x 2.5 mm	137	99	106
WMPB1SPML	Mushroom head latching e/stop	NC	10	600 ~	6	3	1.2	500	10A with gL type fuse	2 x 2.5 mm	137	99	137
WMPB1ST	Momentary contact start	NO	10		6	3	1.2		10A with gL type fuse	2 x 2.5 mm	137	99	106

## Dimensions (mm)

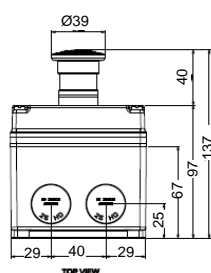

WMPB1SPML

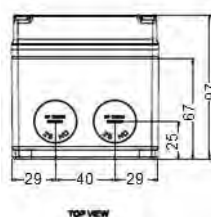
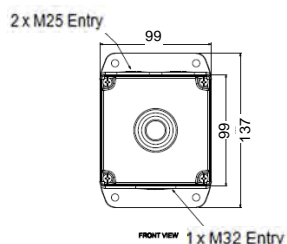

WMPB1

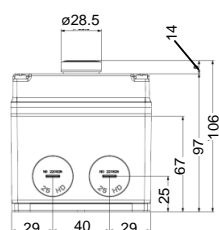
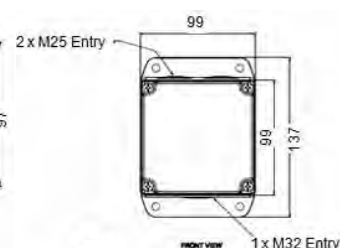

WMPB1ST and WMPB1SP

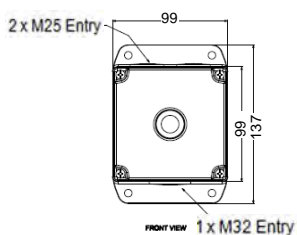

WMPB1

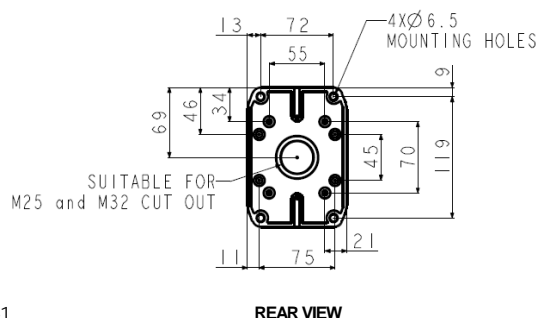

## Appliance Inlets

Clipsal wilcoROWCO Metal Clad Appliance Inlets are available in two sizes. The 32 A ranges have a modular 99 x 201 mm design that allows installers to mix and match switch covers on to two, three, or four gang enclosures (bases). The 63 A product is larger measuring 115 mm x 183 mm which provides additional space for larger cabling.

Clipsal WilcoROWCO appliance inlets range in size from 250 V, 32A to 500 V, 63 A. They feature a downward facing, angled pin housing which enables extension socket plugs to be neatly connected without bulky right angle entry. A screwed or hydrant lock-ring is standard on all models to secure extension sockets and appliance connectors, and ensure IP66 integrity.

The Wilco WB appliance offer a range of alternative sockets for applications from 63 A to 160 A.

The 63 A version is manufactured from cast iron and the 100 A to 160 A products are manufactured from aluminium.

The Wilco range of switched fused appliance inlets are available in 5 pin socket configurations up to 200 A. They feature a 3 mm sheet steel case with cast aluminium covers.

The switch design uses 'M' Clip 'Knife Blade' type contacts capable of withstanding high fault currents.

The compression spring on the switch carriage is designed to provide quick make and quick break action for the contacts.

A cover interlock is provided to prevent the opening of the cover with the switch in the 'ON' position or closed with the cover open.



WB5100R



WMB332R

Heavy Duty - Clipsal 56 Series									
Catalogue Number	I <sub>the</sub> (Amp)	U <sub>i</sub> / U <sub>e</sub> (Volt)	Type of Socket	Cond. Term Size (mm)	O/A Dimensions			Matching plug	Socket config
					Min	Max / Cond.	(H)		
WMB332R	32	250	1P + N + E	[4,16]	239	99	185	56CSC332	I
WMB432R	32	500	3P + E	[4,16]	239	99	185	56CSC432	N
WMB532R	32	500	3P + N + E	[4,16]	239	99	185	56CSC532	S
WMB550R	50	500	3P + N + E	[10,25]	183	116	182	WMP550	A2
WMB563R	63	500	3P + N + E	[10,25]	183	116	182	WMP563	A4
WB5100R	100	500	3P + N + E	-	475	168	315	P5100	74
WB5160R	160	500	3P + N + E	-	475	168	315	P5160	78
WB563R	63	500	3P + N + E	-	203	118	178	WMP563	70

Dimensions (mm)

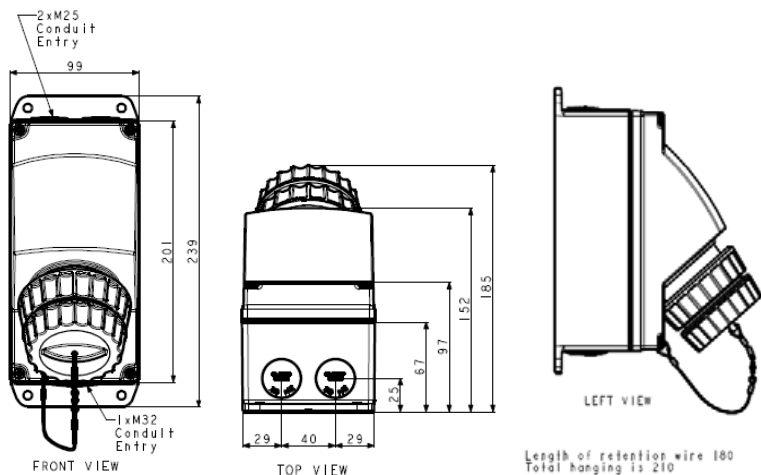

WMB332R and WMB532R

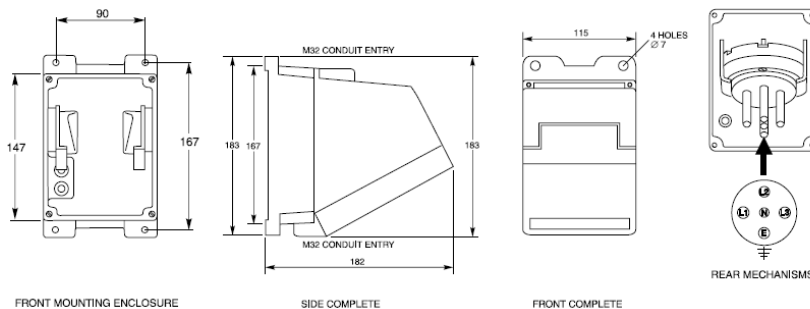

WMB563R

Switched Fused Appliance Inlets



Heavy Duty - Clipsal 56 Series

Catalogue Number	I <sub>the</sub> (Amp)	Ui / Ue (Volt)	Type of Socket	O/A Dimensions			Matching plug	Socket config
				(H)	(W)	(D)		
WCFSP5100R	100	500	3P + N + E	652	394	289	P5100	74
WCFSP5160R	160	500	3P + N + E	652	394	289	P5160	78
WCFSP5200R	200	500	3P + N + E	652	394	289	P5200	82

# Plugs

## Heavy Duty plugs

Wilco Metal Clad plugs are available from 32 A to 200 A. All are fitted with screw-rings for securing to socket outlets. This ensures IP66 rating.

The 100 A - 200 A models have two handles fitted to allow for easy insertion and extraction.



32A range



WMP 50A & 63A series



100A to 200A range

### Heavy Duty - Clipsal 56 Series

Catalogue Number	Rated Current (A)	Rated Voltage (V)	Number of Pins	Pin Description	Conductor Terminal mm <sup>2</sup> Min / Max	Pin Configuration	Gland Nut Thread
WMP450	50	500	4	3P + E	[10,25]	A1	M44
WMP463	63	500	4	3P + E	[10,25]	A2	M44
WMP550	50	500	5	3P + N + E	[10,25]	A3	M44
WMP563	63	500	5	3P + N + E	[10,25]	A4	M44
P132	32	500	3	3P + E	-	22	-
P432	32	500	4	3P + E	-	28	-
P532	32	500	5	3P + N + E	-	29	-
P5100	100	500	5	3P + N + E	-	49	-
P5160	160	500	5	3P + N + E	-	53	-
P5200	200	500	5	3P + N + E	-	57	-

### Dimensions (mm)

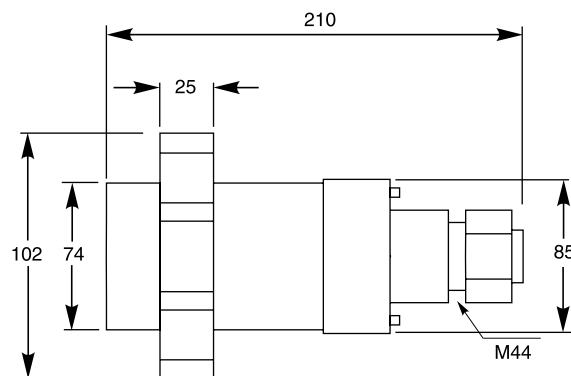

**WMP450**  
**WMP550**  
**WMP463**  
**WMP563**



## Extension Sockets and Appliance Connectors

Wilco Metal Clad appliance connectors are available from 50 A to 200 A. All are fitted with dust caps which covers the socket when the plug is not inserted.

The 100 A - 200 A models have two handles fitted to allow for easy insertion and extraction.



100 to 200A models



WMP 50A & 63A series

Heavy Duty - PDL 56 Series						
Catalogue Number	Rated Current (A)	Rated Voltage (V)	Socket Description	Pin Configuration	Gland Nut Thread	Matching Straight Plug
WMP463R	63	500	3P + E	A3	M44	WMP463
WMP563R	63	500	3P + N + E	A4	M44	WMP563
P5100R	100	500	3P + N + E	75	-	P5100
P5160R	160	500	3P + N + E	79	-	P5160
P5200R	200	500	3P + N + E	83	-	P5200

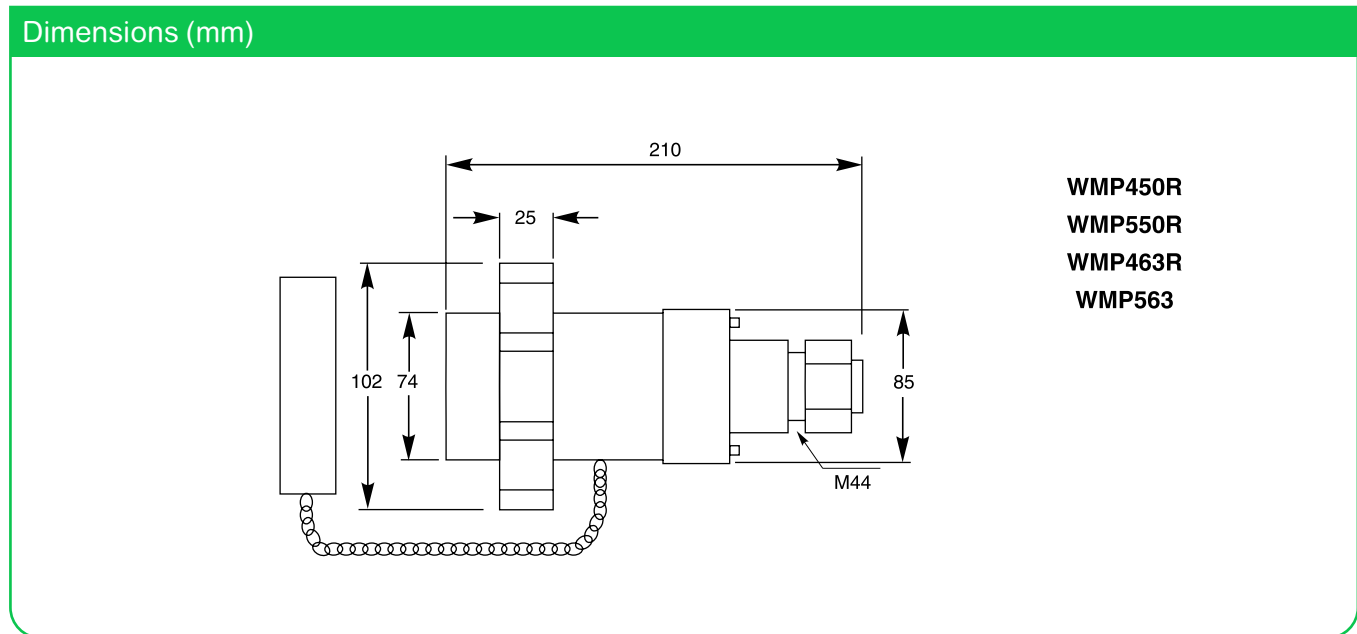

# Special Combinations and Modules

## RCD Protected Socket Outlets

The Clipsal wilcoROWCO Surface 99 x 303 mm surface mount DIN protected sockets provide important RCD protection of popular sockets. The three gang enclosure sizing is kept to a minimum so that these products can be installed into tight spaces (for example, columns or adjacent machinery). If larger DIN enclosures with sockets are required for larger cabling or plugs, then the five pin 500 V WMCDIN563 (measuring 323 x 115 mm) is available for 63 A versions. This product allows the end user to fit their preferred DIN rail mounted protection device.

### Features

- Heavy duty cast aluminium
- DIN enclosure has high visibility yellow enclosure with transparent inspection flap
- Spring loaded socket flap with latch for added safety coverage
- WMDIN2 - 99 mm x 201 mm modular range accepts four module DIN mount products
- WMCDIN\*\*\*RC series - 99 mm x 303 mm modular range that accept 56 series plugs
- IP66 rated to IEC60529
- Padlocking facility (6 mm) in transparent flap
- External and accessible mounting facilities
- Stainless Steel (316 grade) cover mounting screws



WMCDIN563



WMCDIN\*\*\*RC series

Heavy Duty - Clipsal 56 Series											
Catalogue Number	I <sub>the</sub> (Amp)	Ui / Ue (Volt)	Protection	Number of Gangs	Cond. Term Size in mm <sup>2</sup>	O/A Dimensions			Matching Straight plug	Socket Config.	
						Min	Max / Cond.	(D)			
WMCDIN310RC	10	250	30 mA RCD	3 gang	[1.5,16]	341	99	117	56P310	A	
WMCDIN432RC	32	500	30 mA RCD	3 gang	[2.5,16]	341	99	117	56P432	N	
WMCDIN520RC	20	500	30 mA RCD	3 gang	[2.5,16]	341	99	117	56P520	R	
WMCDIN532RC	32	500	30 mA RCD	3 gang	[4,16]	341	99	117	56P532	S	
WMCDIN563	63	500	-	-	[16,25]	323	115	185	66P563	A4	

Dimensions (mm)

WMDIN2

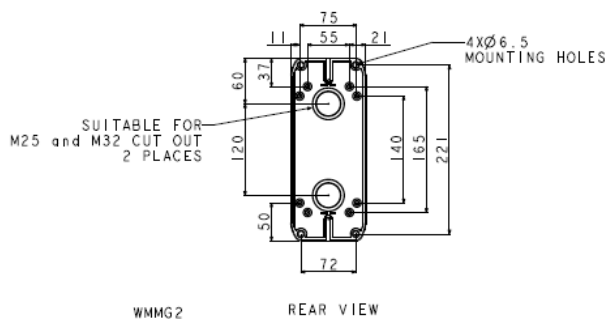
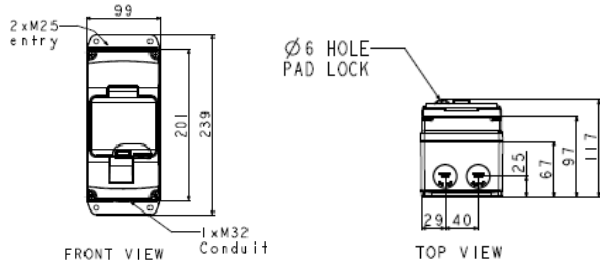

WMCDIN\*\*\*RC

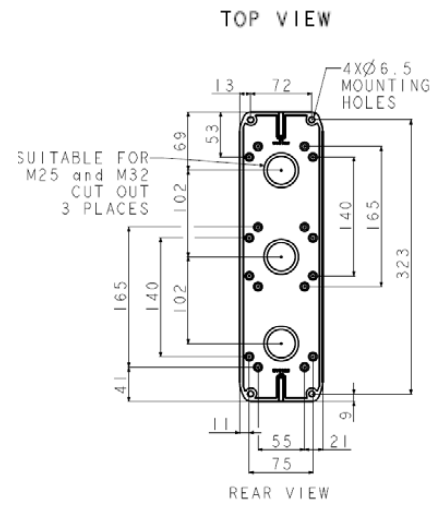
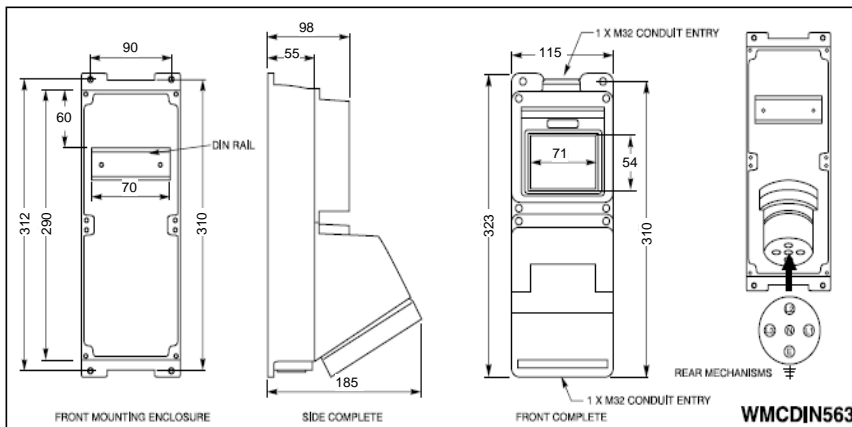
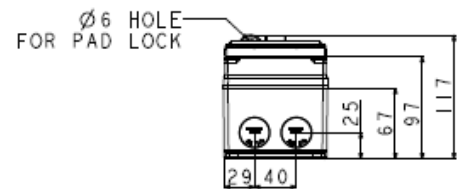
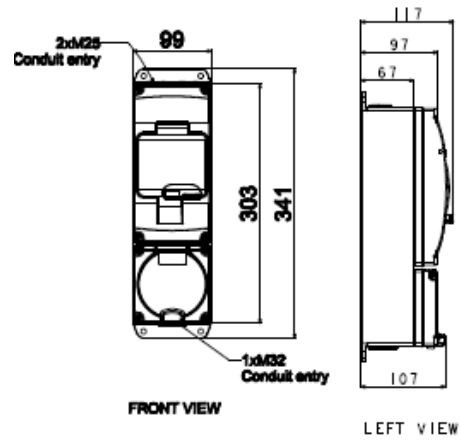

## Mounting Enclosures (Back Boxes)

The wilcoROWCO Metal Clad multigang enclosures allow installers to mix and match either switches, sockets, DIN covers, appliance inlets, and control stations on to one, two, three, or four gang enclosures (bases). Supply cabling and internal connections are also simplified within multigangs as they reduce the need for external conduits or shielded cabling.

### Patented Bridge Divider

All multigangs are supplied with a patented bridge divider (Catalogue No. WM-BD). This unique Clipsal WilcoROWCO product ensures an IP66 rating is achieved without the need to add silicone. It will also assist with cable management within multigang enclosures. This provides peace of mind, increased safety, and is a great time saver.

### Features

- Heavy duty cast aluminium
- IP66 rated to IEC60529 (when covers are installed)
- Modular two, three, or four gang designs
- External and accessible mounting facilities
- WM-BD bridge divider with patented design for multigangs to ensure IP ratings are maintained without the requirement to add silicone to the WM-BD



Heavy Duty - Clipsal 56 Series								
Catalogue Number	No. of Gangs	O/A Dimensions			Matching Points	No. of Conduit Entries (mm)	Cut-out Provision (mm)	Bridges
		(H)	(W)	(D)				
WMMG2	2	239	99	67	8	2 x 25 mm - 1 x 32 mm	2 x 25/32	1
WMMG3	3	341	99	67	4	2 x 25 mm - 1 x 32 mm	3 x 25/32	2
WMMG4	4	239	201	67	8	4 x 25 mm - 2 x 32 mm	4 x 25/32	4

## Dimensions (mm)

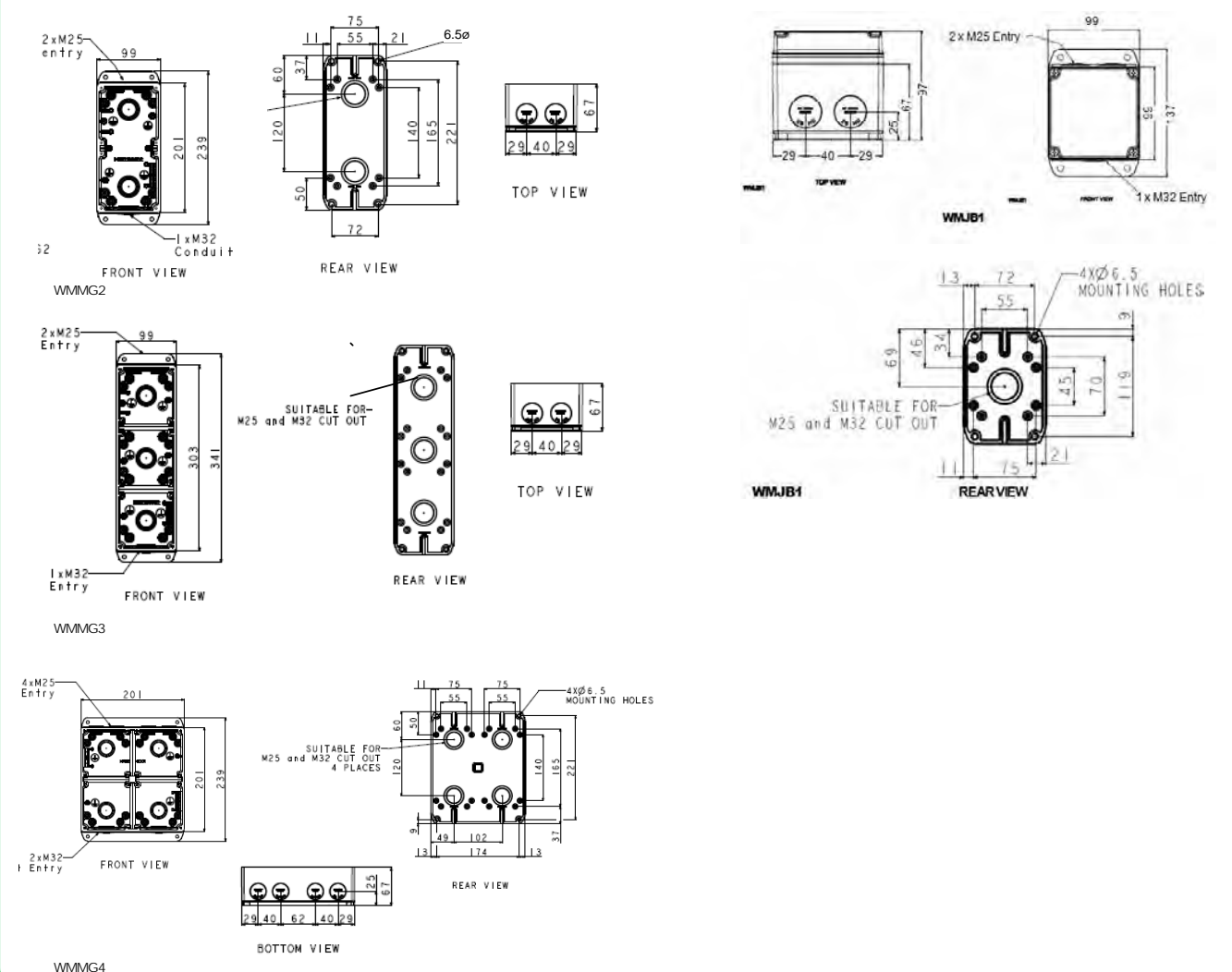

## Adaptable Enclosures

## DIN Rail Accessory Mounting Cover Kits

The Clipsal wilcoROWCO Surface DIN enclosures have modular 99 x 201 mm designs that allows installers to mix and match covers on to two, three, or four gang enclosures (bases). The one piece DIN cover also means there are less access points for dust or water to penetrate.

## Features

- Heavy duty cast aluminium
- DIN enclosure has high visibility yellow enclosure with transparent inspection flap
- Spring loaded socket flap with latch for added safety coverage
- WMDIN2 - 99 mm x 201 mm modular range accepts four module DIN mount products
- IP66 rated to IEC60529
- Padlocking facility (6 mm) in transparent flap
- External and accessible mounting facilities
- Stainless steel (316 grade) cover mounting screws



## Heavy Duty - Clipsal 56 Series

Catalogue Number	Ui/Ue (Volt)	Neon Voltage (Volt)	Module Type	No. of Poles	Module Width	O/A Dimensions		
						L (mm)	W (mm)	D (mm)
WMDIN2	240 / 440	240 / 415	1P, 2P, 3P MCB	4 RCD	4 Max	239	99	117

## Junction Boxes



## Heavy Duty - Clipsal 56 Series

Catalogue Number	Number of Gangs	Conduit Entries	Cut Outs	O/A Dimensions		
				L (mm)	W (mm)	D (mm)
WMJB1	1	2 x 25 mm, 1 x 32 mm	1 x 25/32	137	99	97

## Railway Couplers

### Heavy Duty - Clipsal 56 Series

Catalogue Number	Description	Pin Description	Rated Current		Rated Voltage (V)	Number of Pins	Conductor Terminal mm <sup>2</sup>	O/A Dimensions			
			small contact (A)	large contact (A)				Min / Max	(H)	(W)	(D)
PP2004	4 Pin Receptacle	3 x large, 1 x small with scraping earth	30	250	500	4	15 large, 3.2 small	165	178	326	
P2004PLUG-AL	4 Pin Plug Aluminium	3 x large, 1 x small with scraping earth	30	250	500	4	15 large, 4 small	205	139	387	
P2004-S1008	V Line Dummy Plug and Lever	-	-	-	-	-	-	205	139	387	
P2004S1008AL	Dummy Plug V Line Aluminium	-	-	-	-	-	-	205	139	387	
PP4415-12	44 Pin Receptacle 12 O' Clock Keyway	44 pins	15	-	50 VDC	44	0.25	-	-	-	
PP44-12	44 Pin Dummy Receptacle 12 O' Clock Keyway	-	-	-	-	-	-	-	-	-	

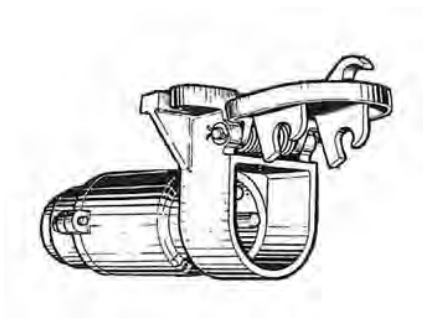

## Accessories and Spare Parts

### Switch, Socket, and Switched Socket Outlet Accessories

All WCFS cable entries are supplied with cork and neoprene gaskets, bolts, nuts, and washers.



#### Heavy Duty - Clipsal 56 Series

Catalogue Number	Description	Compatibility	Current (Amp)	O/A Dimensions		
			Range	(H)	(W)	(D)
WCFS20-B	Standard cable entry for 100 A to 200 A	WCFS products	100 - 200	313	141	102
WCFS6-B	Standard cable entry for 63 A	WCFS products	63	214	88	48
WB5160RS1003	socket inlet for WB5160R	WB5160R	160	-	-	-

### Mounting Enclosure (Back Box) Accessories

Patented Bridge Divider

All multigangs are supplied with a patented bridge divider (Catalogue No. WM-BD). This unique Clipsal product ensures an IP66 rating is achieved without the need to add silicone. It also assists with cable management within multigang enclosures.

The WM-BD is also available separately as a spare part.



#### Heavy Duty - Clipsal 56 Series

Catalogue Number	Description	Colour
WM-BD	Clipsal wilcoRowco enclosure bridge	Aluminium



WMMG4 using WM-BD  
bridge dividers



# Technical Guide

Chemical Resistance Guide					
Chemical type	All Mounting Enclosures	Grey (GY) Transparent Covers	Resistant Orange (RO) Resistant White (RW) Covers	Chemical Grey (CG) Covers	Plugs
<b>Acids</b>					
Hydrochloric 10%	R	R	R	R	R
Nitric 10%	R	LR	R	R	LR
Acetic acid 10%	R	R	R	LR	LR
Sulphuric 100%	R	LR	R	LR	LR
<b>Alkalis</b>					
Sodium hydroxide 10% (Caustic soda)	R	NR	LR	R	LR
Potassium hydroxide 100%	LR	NR	NR	R	LR
<b>Sanitising solutions</b>					
Chlorinated alkaline foaming cleaner 10%	R	NR	NR	R	LR
Ammonium sanitiser	R	NR	NR	R	LR
<b>Vegetable oils</b>					
Olive oil	R	NR	NR	R	LR
Canola oil	R	NR	NR	R	LR
<b>Solvents</b>					
Methane	LR	R	R	-	R
Propane	R	R	R	-	R
Ethylene glycol	R	R	R	-	R
Glycerol (Glycerine)	R	LR	LR	R	R
Methyl alcohol (Methanol)	R	R	R	LR	R
Ethyl alcohol (Ethanol)	R	R	R	NR	R
Aniline	NR	NR	NR	NR	LR
Methyl benzene	NR	NR	LR	NR	LR
Xylene	NR	NR	LR	NR	LR
Dimethyl ethyl	R	R	R	-	R
Acetone	R	LR	LR	LR	LR
Acetophenone	NR	NR	LR	NR	LR
Ethyl methyl ketone	NR	NR	LR	NR	R
Isopropyl Alcohol	-	R	R	NR	R



Chemical Resistance Guide					
Chemical type	All Mounting Enclosures	Grey (GY) Transparent Covers	Resistant Orange (RO) Resistant White (RW) Covers	Chemical Grey (CG) Covers	Plugs
<b>Automotive</b>					
Unleaded Petroleum	R	NR	NR	R	LR
Diesel	-	R	R	NR	LR
Brake Fluid	-	NR	NR	NR	LR
Grease at 60 °C (Rocol 12475)	-	LR	LR	-	-
Grease at 60°C (Rocol Sapphire Hi Temp)	-	LR	LR	-	-
Lubricating oil (10w/40)	-	-	-	-	R
Hydraulic oil (Hf-105L)	-	-	-	-	R
<b>Oxidising agents</b>					
Sodium hypochlorite 5%	R	R	R	R	LR
Hydrogen peroxide 30%	R	R	R	R	LR
<b>Water</b>					
Ambient	R	R	R	R	R
Hot > 60 °C	R	R	R	R	LR
<b>Miscellaneous</b>					
Detergent @ 50 °C	R	LR	NR	R	LR
Magnesium sulphate	R	R	R	-	R
<b>Salts</b>					
Calcium Chloride 10%	R	R	R	R	LR
Sodium Chloride 5%	R	R	R	R	R
Ammonium Hydroxide 100%	R	R	R	R	R

This table should be used as a guide only. The end user should evaluate the suitability of any chemical with any plastic.

Resistant  Limited Resistance  Not Resistant 

When products are required to use in environments with high concentrations of acids, bases, or oils, it is recommended to contact your local Schneider Electric office for support.

# Technical Guide

Industrial Application Matrix			
 Retail and wholesale trade buildings			
Supermarket (Coles, Woolies etc)	<ul style="list-style-type: none"> <li>Plant Rooms</li> <li>Pedestrian Traffic Areas</li> <li>Staff Lunchroom</li> <li>Cool Room For Perishable Storage</li> </ul>	<ul style="list-style-type: none"> <li>Staff Or Public Car Park</li> <li>Toilets / Wet Areas</li> <li>Office</li> <li>Food Preparation Area / Kitchen</li> </ul>	<ul style="list-style-type: none"> <li>Rooftop Plant Platforms</li> <li>Outdoor Lighting</li> <li>Public Eating Area</li> </ul>
Department Store	<ul style="list-style-type: none"> <li>Plant Rooms</li> <li>Pedestrian Traffic Areas</li> <li>Staff Lunchroom</li> <li>Public Eating Area</li> </ul>	<ul style="list-style-type: none"> <li>Warehouse</li> <li>Staff Or Public Car Park</li> <li>Toilets / Wet Areas</li> </ul>	<ul style="list-style-type: none"> <li>Office</li> <li>Outdoor Lighting</li> <li>Rooftop Plant Platforms</li> </ul>
Shopping Centre	<ul style="list-style-type: none"> <li>Plant Rooms</li> <li>Pedestrian Traffic Areas</li> <li>Staff Lunchroom</li> <li>Public Eating Area</li> </ul>	<ul style="list-style-type: none"> <li>Staff or Public Car Park</li> <li>Toilets / Wet Areas</li> <li>Office</li> </ul>	<ul style="list-style-type: none"> <li>Food Preparation Area / Kitchen</li> <li>Rooftop Plant Platforms</li> <li>Outdoor Lighting</li> </ul>
Outdoor Mall	<ul style="list-style-type: none"> <li>Plant Rooms</li> <li>Pedestrian Traffic Areas</li> <li>Staff Lunchroom</li> </ul>	<ul style="list-style-type: none"> <li>Public Eating Area</li> <li>Staff Or Public Car Park</li> <li>Toilets / Wet Areas</li> </ul>	<ul style="list-style-type: none"> <li>Office</li> <li>Outdoor Lighting</li> <li>Rooftop Plant Platforms</li> </ul>
Fast Food Outlet (McD's, KFC, Chicken / Fish & Chip, etc)	<ul style="list-style-type: none"> <li>Public Eating Area</li> <li>Cool Room for Perishable Storage</li> <li>Exposure to Detergents</li> <li>Exposure to Acids / Citrus Based Cleaners</li> </ul>	<ul style="list-style-type: none"> <li>Exposure to Cooking Oil</li> <li>Staff or Public Car Park</li> <li>Toilets / Wet Areas</li> <li>Office</li> </ul>	<ul style="list-style-type: none"> <li>Food Preparation Area / Kitchen</li> <li>Rooftop Plant Platforms</li> <li>Outdoor Lighting</li> <li>Plant Rooms</li> </ul>
Restaurants / Caf�es / Bakery / Commercial Kitchen / Mobile Food Vans	<ul style="list-style-type: none"> <li>Public Eating Area</li> <li>Cool Room for Perishable Storage</li> <li>Exposure to Detergents</li> <li>Exposure to Acids / Citrus Based Cleaners</li> </ul>	<ul style="list-style-type: none"> <li>Exposure to Cooking Oil</li> <li>Staff or Public Car Park</li> <li>Toilets / Wet Areas</li> <li>Office</li> </ul>	<ul style="list-style-type: none"> <li>Food Preparation Area / Kitchen</li> <li>Rooftop Plant Platforms</li> <li>Outdoor Lighting</li> <li>Plant Rooms</li> </ul>
Butchers	<ul style="list-style-type: none"> <li>Pedestrian Traffic Areas</li> <li>Cool Room for Perishable Storage</li> <li>Exposure to Alkali's</li> </ul>	<ul style="list-style-type: none"> <li>Toilets / Wet Areas</li> <li>Food Preparation Area / Kitchen</li> <li>Outdoor Lighting</li> </ul>	<ul style="list-style-type: none"> <li>Staff Lunchroom</li> <li>Staff or Public Car Park</li> <li>Office</li> </ul>
Car Wash	<ul style="list-style-type: none"> <li>Plant Rooms, Pedestrian Traffic Areas</li> <li>Exposure to Detergents</li> <li>Toilets / Wet Areas</li> </ul>	<ul style="list-style-type: none"> <li>Food Preparation Area / Kitchen</li> <li>Outdoor Lighting</li> <li>Staff Lunchroom</li> </ul>	<ul style="list-style-type: none"> <li>Staff or Public Car Park</li> <li>Office</li> <li>Rooftop Plant Platforms</li> </ul>
Petrol Stations / Garage	<ul style="list-style-type: none"> <li>Maintenance Workshop</li> <li>Staff or Public Car Park</li> <li>Toilets / Wet Areas</li> <li>Outdoor Lighting</li> </ul>	<ul style="list-style-type: none"> <li>Plant Rooms, Pedestrian Traffic Areas</li> <li>Staff Lunchroom</li> <li>Public Eating Area</li> <li>Exposure to Detergents</li> </ul>	<ul style="list-style-type: none"> <li>Exposure to Cooking Oil</li> <li>Office</li> <li>Food Preparation Area / Kitchen</li> <li>Rooftop Plant Platforms</li> </ul>
Generator or Hire Equipment (mobile fridges, scissor lifts, etc)	<ul style="list-style-type: none"> <li>Maintenance Workshop</li> <li>Pedestrian Traffic Areas</li> <li>Staff Lunchroom</li> <li>Despatch / Vehicle Loading / Transport Area</li> </ul>	<ul style="list-style-type: none"> <li>Staff or Public Car Park</li> <li>Toilets / Wet Areas</li> <li>Office</li> <li>Outdoor Lighting</li> </ul>	<ul style="list-style-type: none"> <li>Plant Rooms</li> <li>Exposure to Detergents</li> <li>Rooftop Plant Platforms</li> </ul>
 Transport buildings			
Transport Depot freight (road / rail / water) air	<ul style="list-style-type: none"> <li>Staff Lunchroom</li> <li>Despatch / Vehicle Loading / Transport Area</li> <li>Staff or Public Car Park</li> </ul>	<ul style="list-style-type: none"> <li>Toilets / Wet Areas</li> <li>Office</li> <li>Outdoor Lighting</li> </ul>	<ul style="list-style-type: none"> <li>Maintenance Workshop</li> <li>Plant Rooms</li> <li>Rooftop Plant Platforms</li> </ul>
Transport Depot passenger (road / rail / water) air	<ul style="list-style-type: none"> <li>Pedestrian Traffic Areas</li> <li>Staff Lunchroom</li> <li>Despatch / Vehicle Loading / Transport Area</li> <li>Staff Or Public Car Park</li> </ul>	<ul style="list-style-type: none"> <li>Toilets / Wet Areas</li> <li>Office</li> <li>Outdoor Lighting</li> <li>Plant Rooms</li> </ul>	<ul style="list-style-type: none"> <li>Public Eating Area</li> <li>Food Preparation Area / Kitchen</li> <li>Rooftop Plant Platforms</li> </ul>

## Industrial Application Matrix

Marina / Jetties	<ul style="list-style-type: none"> <li>• Pedestrian Traffic Areas</li> <li>• Staff or Public Car Park</li> <li>• Toilets / Wet Areas</li> <li>• Office</li> </ul>	<ul style="list-style-type: none"> <li>• Boat Washdown</li> <li>• Outdoor Lighting</li> <li>• Food Preparation Area / Kitchen</li> </ul>	<ul style="list-style-type: none"> <li>• Rooftop Plant Platforms</li> <li>• Conveyor Belt</li> <li>• Outdoor Bbq's</li> </ul>
Car Parks	<ul style="list-style-type: none"> <li>• Plant Rooms</li> <li>• Pedestrian Traffic Areas</li> <li>• Staff or Public Car Park</li> </ul>	<ul style="list-style-type: none"> <li>• Office</li> <li>• Outdoor Lighting</li> </ul>	<ul style="list-style-type: none"> <li>• Toilets / Wet Areas</li> <li>• Rooftop Plant Platforms</li> </ul>



### Offices

Office Buildings	<ul style="list-style-type: none"> <li>• Staff lunchroom</li> <li>• Staff or public car park</li> <li>• Toilets / wet areas</li> <li>• Office</li> </ul>	<ul style="list-style-type: none"> <li>• Rooftop plant platforms</li> <li>• Plant rooms</li> <li>• Pedestrian traffic areas</li> </ul>
------------------	--	--



### Commercial buildings n.e.c.

Fire Station	<ul style="list-style-type: none"> <li>• Staff lunchroom</li> <li>• Exposure to detergents</li> <li>• Staff or public car park</li> <li>• Toilets / wet areas</li> </ul>	<ul style="list-style-type: none"> <li>• Office</li> <li>• Outdoor lighting</li> <li>• Plant rooms</li> <li>• Rooftop plant platforms</li> </ul>	
Court House	<ul style="list-style-type: none"> <li>• Staff lunchroom</li> <li>• Staff or public car park</li> <li>• Toilets / wet areas</li> <li>• Office</li> </ul>	<ul style="list-style-type: none"> <li>• Outdoor lighting</li> <li>• Plant rooms</li> <li>• Rooftop plant platforms</li> </ul>	
Police station / Gaols / Detention centres	<ul style="list-style-type: none"> <li>• Staff lunchroom</li> <li>• Staff or public car park</li> <li>• Toilets / wet areas</li> </ul>	<ul style="list-style-type: none"> <li>• Office</li> <li>• Outdoor lighting</li> <li>• Plant rooms</li> </ul>	<ul style="list-style-type: none"> <li>• Exposure to detergents</li> <li>• Food preparation area / kitchen</li> <li>• Rooftop plant platforms</li> </ul>



### Factories and other secondary production buildings

Assembly Plant (CHCH, GX etc)	<ul style="list-style-type: none"> <li>• Staff lunchroom</li> <li>• Warehouse</li> <li>• Assembly plant / fabrication area</li> <li>• despatch / vehicle loading / transport area</li> </ul>	<ul style="list-style-type: none"> <li>• Staff or public car park</li> <li>• Toilets / wet areas</li> <li>• Office</li> <li>• Rooftop plant platforms</li> </ul>	<ul style="list-style-type: none"> <li>• Tool room or general fabrication workshop</li> <li>• Plant rooms</li> <li>• Cool room for perishable storage</li> <li>• Conveyor belt</li> </ul>
Dairy / Abattoir / Food (Inghams, Fonterra, Thomas Foods etc)	<ul style="list-style-type: none"> <li>• Plant rooms</li> <li>• Staff lunchroom</li> <li>• Cool room for perishable storage</li> <li>• Warehouse</li> <li>• Exposure to alkali's</li> </ul>	<ul style="list-style-type: none"> <li>• Exposure to detergents</li> <li>• Despatch / vehicle loading / transport area</li> <li>• Staff or public car park</li> <li>• Toilets / wet areas</li> </ul>	<ul style="list-style-type: none"> <li>• Office</li> <li>• Rooftop plant platforms</li> <li>• Maintenance workshop</li> <li>• Conveyor belt</li> </ul>
Foundry (Glass producer, cast metal production)	<ul style="list-style-type: none"> <li>• Staff lunchroom</li> <li>• Warehouse</li> <li>• Minerals processing / furnaces</li> <li>• despatch / vehicle loading / transport area</li> <li>• Staff or public car park</li> </ul>	<ul style="list-style-type: none"> <li>• Toilets / wet areas</li> <li>• Office</li> <li>• Tool room or general fabrication workshop</li> </ul>	<ul style="list-style-type: none"> <li>• Plant rooms</li> <li>• Rooftop plant platforms</li> <li>• Conveyor belt</li> </ul>
Chemical Plant	<ul style="list-style-type: none"> <li>• Plant rooms</li> <li>• Staff lunchroom</li> <li>• Warehouse</li> <li>• Despatch / vehicle loading / transport area</li> <li>• staff or public car park</li> <li>• Toilets / wet areas</li> </ul>	<ul style="list-style-type: none"> <li>• Office</li> <li>• Maintenance workshop</li> <li>• Tool room or general fabrication workshop</li> <li>• Exposure to alkali's</li> <li>• Exposure to detergents</li> </ul>	<ul style="list-style-type: none"> <li>• Exposure to acids / citrus based cleaners</li> <li>• Minerals processing / furnaces</li> <li>• Outdoor storage tanks / ponds / silos</li> <li>• Rooftop plant platforms</li> <li>• Bottling plant</li> <li>• Conveyor belt</li> </ul>

## Industrial Application Matrix

Minerals processing (mining site or secondary production plant)	<ul style="list-style-type: none"> <li>Plant rooms</li> <li>Staff lunchroom</li> <li>Warehouse</li> <li>Minerals processing / furnaces</li> <li>Despatch / vehicle loading / transport area</li> <li>Staff or public car park</li> <li>Toilets / wet areas</li> </ul>	<ul style="list-style-type: none"> <li>Office</li> <li>Maintenance workshop</li> <li>Tool room or general fabrication workshop</li> <li>Cool room for perishable storage</li> <li>Exposure to alkali's</li> <li>Exposure to detergents</li> </ul>	<ul style="list-style-type: none"> <li>Exposure to acids / citrus based cleaners</li> <li>Outdoor storage tanks / ponds / silos</li> <li>Rooftop plant platforms</li> <li>Bottling plant</li> <li>Conveyor belt</li> </ul>
General Fabricator	<ul style="list-style-type: none"> <li>Maintenance workshop</li> <li>Tool room or general fabrication workshop</li> <li>Staff lunchroom</li> <li>Staff or public car park</li> <li>Toilets / wet areas</li> </ul>	<ul style="list-style-type: none"> <li>Office</li> <li>Plant rooms</li> <li>Warehouse</li> <li>Assembly plant / fabrication area</li> <li>Exposure to detergents</li> </ul>	<ul style="list-style-type: none"> <li>Exposure to acids / citrus based cleaners</li> <li>Despatch / vehicle loading / transport area</li> <li>Rooftop plant platforms</li> </ul>
Winery, Brewery, Distillery	<ul style="list-style-type: none"> <li>Staff lunchroom</li> <li>Cool room for perishable storage</li> <li>Warehouse</li> <li>Outdoor storage tanks / ponds / silos</li> <li>Despatch / vehicle loading / transport area</li> <li>Staff or public car park</li> <li>Toilets / wet areas</li> </ul>	<ul style="list-style-type: none"> <li>Office</li> <li>Bottling plant</li> <li>Maintenance workshop</li> <li>Plant rooms</li> <li>Pedestrian traffic areas</li> <li>Public eating area</li> <li>Exposure to detergents</li> </ul>	<ul style="list-style-type: none"> <li>Exposure to acids / citrus based cleaners</li> <li>Bottle / vat sterilising</li> <li>Food preparation area / kitchen</li> <li>Rooftop plant platforms</li> <li>Conveyor belt</li> </ul>
Cabinet Maker / Spray Painter	<ul style="list-style-type: none"> <li>Maintenance workshop</li> <li>Staff lunchroom</li> <li>Staff or public car park</li> <li>Toilets / wet areas</li> <li>Office</li> </ul>	<ul style="list-style-type: none"> <li>Assembly plant / fabrication area</li> <li>Despatch / vehicle loading / transport area</li> <li>Rooftop plant platforms</li> </ul>	
Motor / Rail body builder	<ul style="list-style-type: none"> <li>Maintenance workshop</li> <li>Staff lunchroom</li> <li>Staff or public car park</li> <li>Toilets / wet areas</li> </ul>	<ul style="list-style-type: none"> <li>Office</li> <li>Tool room or general fabrication workshop</li> <li>Plant rooms</li> </ul>	<ul style="list-style-type: none"> <li>Assembly plant / fabrication area</li> <li>Despatch / vehicle loading / transport area</li> <li>Rooftop plant platforms</li> </ul>



### Warehouses / Distribution Centres

Refrigerated Storage (Perishables such as food & beverage)	<ul style="list-style-type: none"> <li>Plant rooms</li> <li>Staff lunchroom</li> <li>Cool room for perishable storage</li> <li>Despatch / vehicle loading / transport area</li> </ul>	<ul style="list-style-type: none"> <li>Staff or public car park</li> <li>Toilets / wet areas</li> <li>Office</li> <li>Maintenance workshop</li> </ul>	<ul style="list-style-type: none"> <li>Tool room or general fabrication workshop</li> <li>Warehouse</li> <li>Rooftop plant platforms</li> </ul>
General Storage (non-perishable items)	<ul style="list-style-type: none"> <li>Staff lunchroom</li> <li>Despatch / vehicle loading / transport area</li> <li>Staff or public car park</li> <li>Toilets / wet areas</li> </ul>	<ul style="list-style-type: none"> <li>Office</li> <li>Maintenance workshop</li> <li>Tool room or general fabrication workshop</li> </ul>	<ul style="list-style-type: none"> <li>Plant rooms</li> <li>Cool room for perishable storage</li> <li>Warehouse</li> <li>Rooftop plant platforms</li> </ul>



### Agricultural and aquacultural buildings

Farm Out Buildings (Barns, shearing sheds etc)	<ul style="list-style-type: none"> <li>Maintenance workshop</li> </ul>		
Primary production (milking shed)	<ul style="list-style-type: none"> <li>Despatch / vehicle loading / transport area</li> <li>Office</li> <li>Maintenance workshop</li> <li>Plant rooms</li> <li>Cool room for perishable storage</li> </ul>	<ul style="list-style-type: none"> <li>Exposure to alkali's</li> <li>Exposure to detergents</li> <li>Outdoor storage tanks / ponds / silos</li> <li>Staff or public car park</li> <li>Toilets / wet areas</li> </ul>	
Aquaculture / Fish Farms	<ul style="list-style-type: none"> <li>Staff lunchroom</li> <li>Warehouse</li> <li>Minerals processing / furnaces</li> <li>despatch / vehicle loading / transport area</li> <li>Staff or public car park</li> </ul>	<ul style="list-style-type: none"> <li>Toilets / wet areas</li> <li>Office</li> <li>Tool room or general fabrication workshop</li> </ul>	<ul style="list-style-type: none"> <li>Plant rooms</li> <li>Rooftop plant platforms</li> <li>Conveyor belt</li> </ul>
Wheat Silo / Storage	<ul style="list-style-type: none"> <li>Plant rooms</li> <li>Staff lunchroom</li> <li>Warehouse</li> <li>Despatch / vehicle loading / transport area</li> <li>staff or public car park</li> <li>Toilets / wet areas</li> </ul>	<ul style="list-style-type: none"> <li>Office</li> <li>Maintenance workshop</li> <li>Tool room or general fabrication workshop</li> <li>Exposure to alkali's</li> <li>Exposure to detergents</li> </ul>	<ul style="list-style-type: none"> <li>Exposure to acids / citrus based cleaners</li> <li>Minerals processing / furnaces</li> <li>Outdoor storage tanks / ponds / silos</li> <li>Rooftop plant platforms</li> <li>Bottling plant</li> <li>Conveyor belt</li> </ul>

## Industrial Application Matrix

 Other industrial buildings n.e.c.			
Electrical generation	<ul style="list-style-type: none"> <li>Maintenance workshop</li> <li>Staff lunchroom</li> <li>Staff or public car park</li> <li>Toilets / wet areas</li> </ul>	<ul style="list-style-type: none"> <li>Office</li> <li>Tool room or general fabrication workshop</li> <li>Plant rooms</li> </ul>	<ul style="list-style-type: none"> <li>Rooftop plant platforms</li> <li>Outdoor lighting</li> </ul>
Water Treatment (reservoir etc)	<ul style="list-style-type: none"> <li>Maintenance workshop</li> <li>Staff lunchroom</li> <li>Outdoor storage tanks / ponds / silos</li> <li>Staff or public car park</li> <li>Toilets / wet areas</li> </ul>	<ul style="list-style-type: none"> <li>Office</li> <li>Tool room or general fabrication workshop</li> <li>Plant rooms</li> <li>Pedestrian traffic areas</li> </ul>	<ul style="list-style-type: none"> <li>Exposure to detergents</li> <li>Exposure to acids / citrus based cleaners</li> <li>Rooftop plant platforms</li> <li>Outdoor lighting</li> </ul>
Waste Water Treatment	<ul style="list-style-type: none"> <li>Maintenance workshop</li> <li>Staff lunchroom</li> <li>Outdoor storage tanks / ponds / silos</li> <li>Staff or public car park</li> <li>Toilets / wet areas</li> </ul>	<ul style="list-style-type: none"> <li>Office</li> <li>Tool room or general fabrication workshop</li> <li>Plant rooms</li> <li>Pedestrian traffic areas</li> </ul>	<ul style="list-style-type: none"> <li>Exposure to detergents</li> <li>Exposure to acids / citrus based cleaners</li> <li>Rooftop plant platforms</li> <li>Outdoor lighting</li> </ul>

 Education buildings			
School / University	<ul style="list-style-type: none"> <li>Pedestrian traffic areas</li> <li>Staff lunchroom</li> <li>Public eating area</li> <li>Cool room for perishable storage</li> <li>Warehouse</li> </ul>	<ul style="list-style-type: none"> <li>Staff or public car park</li> <li>Toilets / wet areas</li> <li>Office</li> <li>Food preparation area / kitchen</li> <li>Rooftop plant platforms</li> </ul>	<ul style="list-style-type: none"> <li>Maintenance workshop</li> <li>Plant rooms</li> <li>Exposure to cooking oil</li> <li>Swimming pool / growing pond</li> <li>Outdoor lighting</li> </ul>
Boarding / Accomodation	<ul style="list-style-type: none"> <li>Pedestrian traffic areas</li> <li>Staff lunchroom</li> <li>Public eating area</li> <li>Cool room for perishable storage</li> </ul>	<ul style="list-style-type: none"> <li>Staff or public car park</li> <li>Toilets / wet areas</li> <li>Office</li> <li>Food preparation area / kitchen</li> </ul>	<ul style="list-style-type: none"> <li>Rooftop plant platforms</li> <li>Plant rooms</li> <li>Swimming pool / growing pond</li> <li>Outdoor lighting</li> </ul>

 Religion buildings			
Places of Worship (churches etc)	<ul style="list-style-type: none"> <li>Pedestrian traffic areas</li> <li>Staff or public car park</li> <li>Toilets / wet areas</li> <li>Public eating area</li> </ul>	<ul style="list-style-type: none"> <li>Cool room for perishable storage</li> <li>Exposure to cooking oil</li> <li>Office</li> <li>Food preparation area / kitchen</li> </ul>	<ul style="list-style-type: none"> <li>Rooftop plant platforms</li> <li>Outdoor lighting</li> </ul>

 Aged care facilities			
Aged Care / Nursing Home	<ul style="list-style-type: none"> <li>Pedestrian traffic areas</li> <li>Staff lunchroom</li> <li>Public eating area</li> <li>Cool room for perishable storage</li> <li>Staff or public car park</li> </ul>	<ul style="list-style-type: none"> <li>Toilets / wet areas</li> <li>Office</li> <li>Food preparation area / kitchen</li> <li>Maintenance workshop</li> </ul>	<ul style="list-style-type: none"> <li>Plant rooms</li> <li>Exposure to cooking oil</li> <li>Swimming pool / growing pond</li> <li>Outdoor lighting</li> </ul>

 Health buildings			
Hospital	<ul style="list-style-type: none"> <li>Maintenance workshop</li> <li>Plant rooms</li> <li>Pedestrian traffic areas</li> <li>Staff lunchroom</li> <li>Public eating area</li> </ul>	<ul style="list-style-type: none"> <li>Cool room for perishable storage</li> <li>Despatch / vehicle loading / transport area</li> <li>Staff or public car park</li> <li>Toilets / wet areas</li> </ul>	<ul style="list-style-type: none"> <li>Office</li> <li>Food preparation area / kitchen</li> <li>Rooftop plant platforms</li> <li>Swimming pool / growing pond</li> </ul>
GP Clinic / Dentist	<ul style="list-style-type: none"> <li>Staff lunchroom</li> <li>Exposure to detergents</li> <li>Staff or public car park</li> </ul>	<ul style="list-style-type: none"> <li>Office</li> <li>Toilets / wet areas</li> </ul>	<ul style="list-style-type: none"> <li>Cool room for perishable storage</li> <li>Rooftop plant platforms</li> </ul>
Radiographer / Pathologist	<ul style="list-style-type: none"> <li>Staff lunchroom</li> <li>Exposure to detergents</li> <li>Staff or public car park</li> </ul>	<ul style="list-style-type: none"> <li>Office</li> <li>Toilets / wet areas</li> </ul>	<ul style="list-style-type: none"> <li>Cool room for perishable storage</li> <li>Rooftop plant platforms</li> </ul>
Laboratories	<ul style="list-style-type: none"> <li>Staff lunchroom</li> <li>Exposure to detergents</li> <li>Staff or public car park</li> </ul>	<ul style="list-style-type: none"> <li>Office</li> <li>Toilets / wet areas</li> </ul>	<ul style="list-style-type: none"> <li>Cool room for perishable storage</li> <li>Rooftop plant platforms</li> </ul>

## Industrial Application Matrix







 Entertainment and recreation buildings			
Oval / Arena	<ul style="list-style-type: none"> <li>• Pedestrian traffic areas</li> <li>• Staff lunchroom</li> <li>• Public eating area</li> <li>• Cool room for perishable storage</li> <li>• Staff or public car park</li> </ul>	<ul style="list-style-type: none"> <li>• Toilets / wet areas</li> <li>• Office</li> <li>• Food preparation area / kitchen</li> <li>• Maintenance workshop</li> </ul>	<ul style="list-style-type: none"> <li>• Plant rooms</li> <li>• Exposure to cooking oil</li> <li>• Rooftop plant platforms</li> <li>• Outdoor lighting</li> </ul>
Gym / Tennis Centre	<ul style="list-style-type: none"> <li>• Pedestrian traffic areas</li> <li>• Staff lunchroom</li> <li>• Public eating area</li> <li>• Cool room for perishable storage</li> <li>• Staff or public car park</li> </ul>	<ul style="list-style-type: none"> <li>• Toilets / wet areas</li> <li>• Office</li> <li>• Food preparation area / kitchen</li> <li>• Maintenance workshop</li> </ul>	<ul style="list-style-type: none"> <li>• Plant rooms</li> <li>• Exposure to cooking oil</li> <li>• Rooftop plant platforms</li> <li>• Outdoor lighting</li> </ul>
Entertainment Centre / Theater / Cinema	<ul style="list-style-type: none"> <li>• Pedestrian traffic areas</li> <li>• Staff lunchroom</li> <li>• Public eating area</li> <li>• Cool room for perishable storage</li> <li>• Staff or public car park</li> </ul>	<ul style="list-style-type: none"> <li>• Toilets / wet areas</li> <li>• Office</li> <li>• Food preparation area / kitchen</li> <li>• Maintenance workshop</li> </ul>	<ul style="list-style-type: none"> <li>• Plant rooms</li> <li>• Exposure to cooking oil</li> <li>• Rooftop plant platforms</li> <li>• Outdoor lighting</li> </ul>
Aquatic centre (swimming pools, aquariums etc)	<ul style="list-style-type: none"> <li>• Pedestrian traffic areas</li> <li>• Staff lunchroom</li> <li>• Public eating area</li> <li>• Cool room for perishable storage</li> <li>• Staff or public car park</li> </ul>	<ul style="list-style-type: none"> <li>• Toilets / wet areas</li> <li>• Office</li> <li>• Food preparation area / kitchen</li> <li>• Maintenance workshop</li> </ul>	<ul style="list-style-type: none"> <li>• Plant rooms</li> <li>• Exposure to cooking oil</li> <li>• Rooftop plant platforms</li> <li>• Outdoor lighting</li> </ul>
Libraries / Museums	<ul style="list-style-type: none"> <li>• Pedestrian traffic areas</li> <li>• Staff lunchroom</li> <li>• Public eating area</li> <li>• Cool room for perishable storage</li> <li>• Staff or public car park</li> </ul>	<ul style="list-style-type: none"> <li>• Toilets / wet areas</li> <li>• Office</li> <li>• Food preparation area / kitchen</li> <li>• Maintenance workshop</li> </ul>	<ul style="list-style-type: none"> <li>• Plant rooms</li> <li>• Exposure to cooking oil</li> <li>• Rooftop plant platforms</li> <li>• Outdoor lighting</li> </ul>
Casino	<ul style="list-style-type: none"> <li>• Pedestrian traffic areas</li> <li>• Staff lunchroom</li> <li>• Public eating area</li> <li>• Cool room for perishable storage</li> <li>• Staff or public car park</li> </ul>	<ul style="list-style-type: none"> <li>• Toilets / wet areas</li> <li>• Office</li> <li>• Food preparation area / kitchen</li> <li>• Maintenance workshop</li> </ul>	<ul style="list-style-type: none"> <li>• Plant rooms</li> <li>• Exposure to cooking oil</li> <li>• Rooftop plant platforms</li> <li>• Outdoor lighting</li> </ul>
Public Parks / Beaches	<ul style="list-style-type: none"> <li>• Pedestrian traffic areas</li> <li>• Toilets / wet areas</li> <li>• Outdoor bbq's</li> </ul>	<ul style="list-style-type: none"> <li>• Outdoor lighting</li> <li>• Public eating area</li> <li>• Staff or public car park</li> </ul>	

 Short term accommodation buildings			
Hotel	<ul style="list-style-type: none"> <li>• Plant rooms</li> <li>• Pedestrian traffic areas</li> <li>• Staff lunchroom</li> <li>• Public eating area</li> <li>• Cool room for perishable storage</li> </ul>	<ul style="list-style-type: none"> <li>• Staff or public car park</li> <li>• Toilets / wet areas</li> <li>• Office</li> <li>• Food preparation area / kitchen</li> </ul>	<ul style="list-style-type: none"> <li>• Maintenance workshop</li> <li>• Exposure to cooking oil</li> <li>• Rooftop plant platforms</li> <li>• Swimming pool / growing pond</li> </ul>
Serviced Apartments	<ul style="list-style-type: none"> <li>• Plant rooms</li> <li>• Pedestrian traffic areas</li> <li>• Staff lunchroom</li> <li>• Staff or public car park</li> </ul>	<ul style="list-style-type: none"> <li>• Toilets / wet areas</li> <li>• Office</li> <li>• Maintenance workshop</li> <li>• Cool room for perishable storage</li> </ul>	<ul style="list-style-type: none"> <li>• Exposure to cooking oil</li> <li>• Rooftop plant platforms</li> <li>• Swimming pool / growing pond</li> </ul>

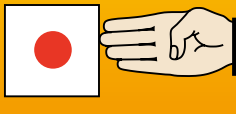
 Other non-residential n.e.c.			
Data Centre	<ul style="list-style-type: none"> <li>• Plant rooms</li> <li>• Staff lunchroom</li> <li>• Staff or public car park</li> <li>• Toilets / wet areas</li> <li>• Office</li> <li>• Rooftop plant platforms</li> </ul>		

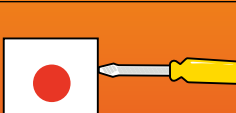
## International Protection Ratings



### Protection against solids

	TEST	PROTECTION
x	No test applied	No specific protection
0	No test applied	Inherent degree of protection
1		Protected against solid objects equal to or greater than 50 mm diameter. (eg. accidental contact with hand)
2		Protected against solid objects equal to or greater than 12.5mm diameter. (eg. contact with finger)
3		Protected against solid objects equal to or greater than 2.5mm diameter. (eg. tools and wires)
4		Protected against solid objects equal to or greater than 1mm diameter. (eg. fine tools and wires)
5		Protected against quantities of dust that could interfere with satisfactory operation.
6		Completely protected against dust.

Defined by IEC 60529  
DIN 40050 CEI 70-1

To Australian standards AS 60529-2004  
Degrees of protection provided by enclosures.  
(IP Code)

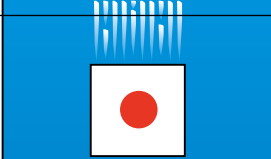
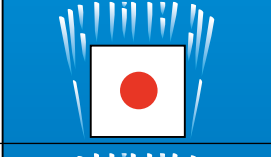
### Protection against liquids

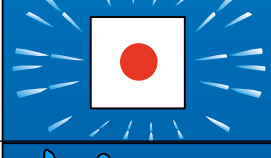
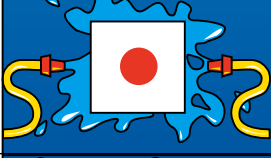
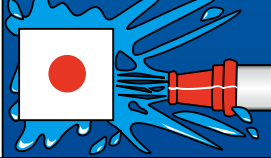
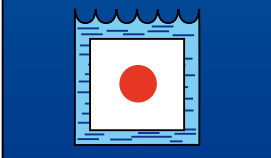
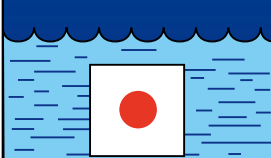
	TEST	PROTECTION
x	No test applied	No specific protection
0	No test applied	Inherent degree of protection
1		Protected against drops of water falling vertically.
2		Protected against drops of water falling at up to 15 degrees from the vertical.
3		Protected against spraying water at up to 60 degrees from the vertical.
4		Protected against splashing water from all directions.
5		Protected against jets of water from all directions.
6		Protected against jets of water of similar force to heavy seas.
7		Protected against the effects of temporary immersion.
8		Protected against the effects of continuous immersion.

Defined by IEC 60529

## Technical Terms

The following technical terms are brief descriptions indicating the tests involved to attain ratings. For further information refer to the standards indicated.

### M-Rating (refer AS/NZS3133)

Clipsal switches and switched socket outlets are marked with an M-Rating. This indicates that these products have been tested and found suitable for switching locked rotor current.

In part, this test involves 50 operations, make and break of the nominated locked rotor current at 0.5 power factor lagging. The switch will not fail to interrupt the current or fail in any way electrically or mechanically.

### AC-21 (refer AS/NZS3947)

Switching of resistive loads, including moderate overloads.

In part, this involves five make and break operations, at 1 ½ times rated current and 1.1 times rated voltage at 0.95 cos.

Additional mechanical no load and electrical endurance tests at rated current and voltage at 0.95 cos are conducted.

### AC-22 (refer AS/NZS3947)

Switched of mixed resistive and inductive loads, including moderate overloads.

In part, this involves five make and break operations at three times rated current and 1.1 times rated voltage at 0.65 cos.

Additional mechanical no load and electrical endurance tests at rated current and voltage at 0.65 cos.

### AC-23 (refer AS/NZS3947)

Switching of motor loads or highly inductive loads.

In part, this involves five make and break operations at:

- 10 times rated current make
- 1.1 times rated voltage make
- 0.35 cos

- 8 times rated current break
- 1.1 times rated voltage break
- 0.35 cos

Additional mechanical at no load and electrical endurance tests at rated current and voltage at 0.35 cos are conducted.

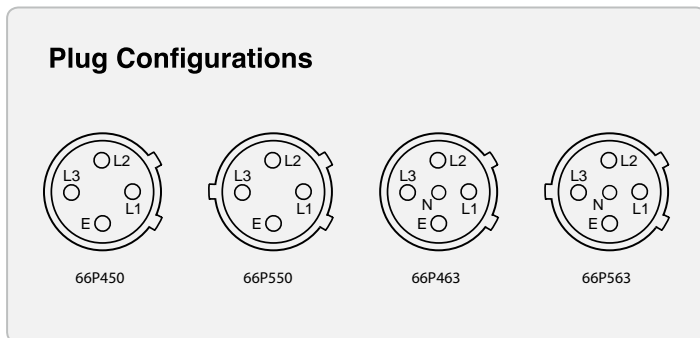



## Plug and socket configuration

### 2 & 3 Pin



10A 250V  
A



15A 250V  
B



10A 250V  
C



10A 110V  
D



15A 32V  
Polarised  
E



20A 250V  
F



10A 250V  
G



20A 250V  
H



32A 250V  
I



10A 110V  
J

### 4 Pin



10A 500V  
K



20A 500V  
L



16A 500V  
(unique)  
M



32A 500V  
N



40A 500V  
O



50A 500V  
P



### 5 Pin

10A 500V  
Q



20A 500V  
R



32A 500V  
S



40A 500V  
T



50A 500V  
U



### 6 Pin

10A 500V  
V



### 7 Pin

10A 500V  
W



20A 500V  
X

### 2 & 3 Pin



10A 250V  
A



15A 250V  
B



10A 250V  
C



10A 110V  
D



15A 32V  
Polarised  
E



20A 250V  
F



10A 250V  
G



20A 250V  
H



32A 250V  
I



10A 110V  
J



10A 500V  
K



20A 500V  
L



16A 500V  
(unique)  
M



32A 500V  
N



40A 500V  
O



50A 500V  
P



10A 500V  
Q



20A 500V  
R



32A 500V  
S



40A 500V  
T



50A 500V  
U



### 6 Pin

10A 500V  
V



### 7 Pin

10A 500V  
W



20A 500V  
X





Schneider Electric (Australia) Pty. Ltd.  
33-37 Port Wakefield Road,  
Gepps Cross, South Australia, 5085  
PO Box 132, Enfield Plaza,  
South Australia, 5085  
[www.schneider-electric.com.au](http://www.schneider-electric.com.au)  
998-21035829\_AU-GB

Consumer Support Enquiries  
Phone: 1300 669 925  
Website: [clipsal.com/contactus](http://clipsal.com/contactus)

National Customer Care (trade only)  
Phone: 1300 369 233  
Email: [plugin@clipsal.com.au](mailto:plugin@clipsal.com.au)  
©2020 Schneider Electric. All Rights  
Reserved. Iconic and Clipsal Iconic  
are trademarks of Schneider Electric  
(Australia) PTY Limited.

[clipsal.com](http://clipsal.com)

Life Is  On

  
by Schneider Electric