

10GBE SHIELDED CAT6A LSZH NETWORK CABLE

PART NUMBER: **C6A-YY-XXXX-SH**

*YY = LENGTH

*XXXX = COLOUR

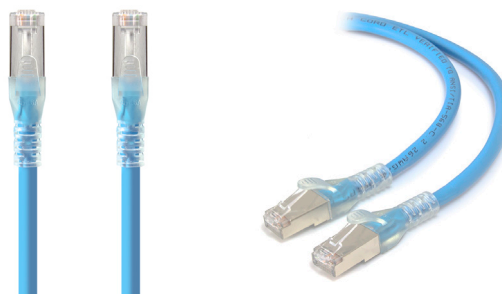

PRODUCT FEATURES

- Performance rated for 750 MHz bandwidth
- Suit for up to 10G LANs, include 10GBASE-T Ethernet, 1000BASE-TX Fast Ethernet, & Lower
- Each twisted pair in the cable is individually wrapped in aluminum foil Mylar (100% Coverage)
- Overall Copper Braided Shielded
- Comes with LSZH (Low Smoke Zero Halogen) Jacket
- Category 6A SFTP cable wired straight through. 26 AWG, gold plated 8x8 (RJ45) plugs
- Snag-free strain relief molded boot provides secure and accurate connection
- Suppresses ANEXT (Alien Near End Cross Talk) and delivers superior 10GbE performance up to 100mt.
- A-Tick Compliant as per ACMA requirement
- ETL verified to TIA/EIA-568C.2.1 Category 6a
- Compliant to IEC 802.3an standards & ISO/IEC 11801
- UL Approved
- Warranty: Lifetime*

GUARANTEE/WARRANTY

Serveredge products are manufactured at the highest standards using highest quality materials at an affordable price. This Serveredge product comes with Lifetime warranty for that extra piece of mind. Subject to Serveredge Terms and Conditions*

PRODUCT DESCRIPTION

Serveredge Cat6A shielded network cables are designed to meet and exceed the requirements for the next generation 10GBASE-T applications. The Serveredge Cat6A cabling system provides an End to End solution that provides a guaranteed 750 Mhz of usable bandwidth. The Serveredge Cat6A solution consists of Pre Terminated Cables, Patch Panels, Modular Jacks, Connectors and Bulk Installation Cables.

PRODUCT SPECIFICATION

Wiring Scheme	T568A
Standard	Category 6a TIA/EIA-568C-2.1
Connector	50 micron gold-plated RJ45
Temperature Rating	75°C
Voltage Rating	30V
Approvals	A-Tick, ETL, UL, IEEE, RoHS Compliant
Package Type:	Polybag
Jacket	LSZH (Low Smoke Zero Halogen)
Connector Type	8P8C (RJ45)
Conductor Type	26AWG (7/0.16), Stranded Bare Copper

10GBE SHIELDED CAT6A LSZH NETWORK CABLE

PART NUMBER: C6A-YY-XXXX-SH

*YY = LENGTH
*XXXX = COLOUR

DESIGN

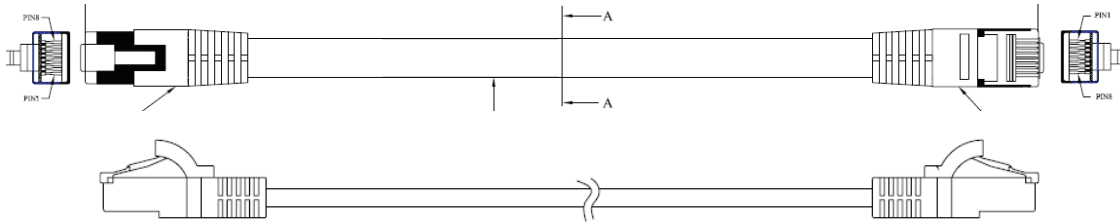

Stranded bare copper conductors insulated with foam thermoplastics polyolefin. Two insulated conductors twisted together to form a pair shielded with Aluminum/polyester foil. Four such pairs cabled to form the basic unit. Tinned copper braiding overall the 4pairs. Overall jacket with LSZH compound.

CABLE SPECIFICATIONS

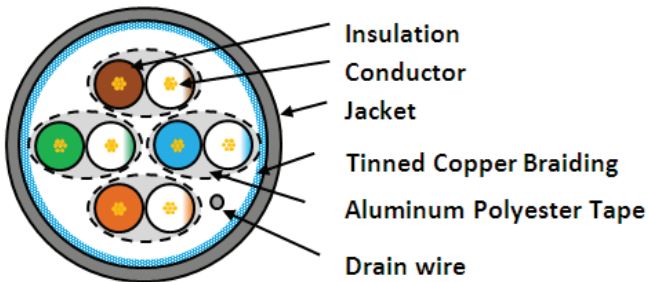

Conductor	7/0.16±0.01mm 26AWG Stranded bare copper
Insulator	Insulator 1.05± 0.05mm Foam PE Min. Thickness 0.26mm
Shield	7/0.16 ±0.008mm Type (each Pair Shielded): Aluminum Polyester Tape Type (Overall braiding): Tinned Copper 40% Braiding
Jacket	6.32± 0.3mm LSZH Avg. thickness: 0.52mm Min. thickness: 0.47mm

WIRING DIAGRAM

T568A WIRING DIAGRAM

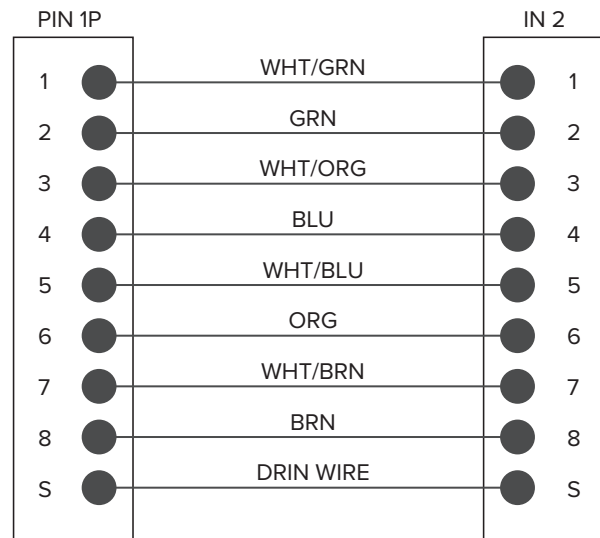

10GBE SHIELDED CAT6A LSZH NETWORK CABLE

PART NUMBER: C6A-YY-XXXX-SH





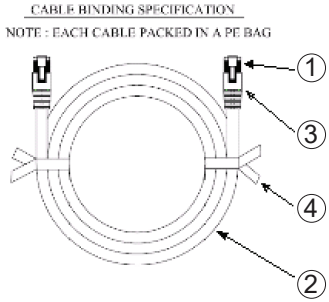





*YY = LENGTH
*XXXX = COLOUR

PARTS



No.	Descriptions	Material	Q'ty
1	50u RJ45 PLUG (SHIELDED)	PC	2
2	01m	LSZH	1
3	Assembly SR	PVC	2
4	Magic Band	PVC	2

PART NO.

Part No.	Length	Packaging	Colour
C6A-0.5-XXXX-SH	0.5m	PE Bag	
C6A-01-XXXX-SH	01m	PE Bag	
C6A-1.5-XXXX-SH	1.5m	PE Bag	
C6A-02-XXXX-SH	02m	PE Bag	
C6A-03-XXXX-SH	03m	PE Bag	
C6A-05-XXXX-SH	05m	PE Bag	
C6A-7.5-XXXX-SH	7.5m	PE Bag	
C6A-10-XXXX-SH	10m	PE Bag	
C6A-15-XXXX-SH	15m	PE Bag	
C6A-20-XXXX-SH	20m	PE Bag	
C6A-25-XXXX-SH	25m	PE Bag	
C6A-30-XXXX-SH	30m	PE Bag	