



TDUX - Inflatable Duct Seal, size 35

- Flexible and reliable wraparound inflatable sealing system for cables
- Fast and easy to install or remove, even when water is flowing out of the duct
- Independent of duct or cable ovality
- Water and airtight up to 50 kPa (7 psi)
- Environmentally friendly, non-toxic and resistant to chemicals

Product Classification

Regional Availability	EMEA
Product Type	Cable duct seal
Product Series	TDUX
Ordering Note	When sealing more than two cables in a duct, separate orderable TDUX-CL clips are to be used

Dimensions

Width	120 mm 4.724 in
Length	155 mm 6.102 in
Cable Diameter, maximum	25 mm 0.984 in
Cable Diameter, minimum	12 mm 0.472 in
Conduit Inner Diameter, maximum	35 mm 1.378 in
Conduit Inner Diameter, minimum	25 mm 0.984 in

Dimension Drawing

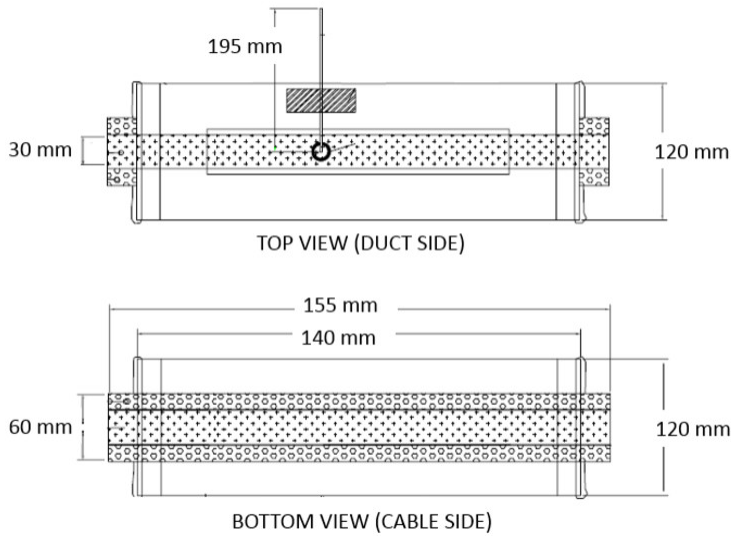

Environmental Specifications

Installation temperature -5 °C to +40 °C (+23 °F to +104 °F)

Packaging and Weights

Included Inflatable bladder with sealing mechanism

Packaging quantity 10

Regulatory Compliance/Certifications

Agency

CHINA-ROHS

REACH-SVHC

ROHS

Classification

Below maximum concentration value

Compliant as per SVHC revision on www.commscope.com/ProductCompliance

Compliant

