

RT2705 | 27RU 800w x 600d Frame Assembly

The RT2 Series is a fully customisable cabinet design with multiple size and panel configurations suitable for any installation requirement.

The cabinets can be equipped with the Racktech iQ cable management system ideal for large volumes of cables and patch leads.

Features

- › Modular design with aluminum extrusion
- › Durable powder-coated finish
- › Cabinet is designed for strength and flexibility and can take up to 1000kg static load capacity
- › Fully adjustable mounting rails with RU markings on the front for quick installation
- › Doors are available in acrylic, steel, vented, curved vented or bifold vented
- › Doors can be left or right hand hinged
- › Concealed hinges and fasteners
- › Quick release hinges and latches
- › Vertical power rails can be mounted on uprights
- › Fans, castors, plinths, cable managers and chimneys are available
- › Large cable access entry in the roof provides access for overhead cable egress
- › Side panel with ventilation at the bottom allows for passive airflow throughout the cabinet
- › Ripple Black Gloss is the standard colour. Other colours are available upon request. MOQ applies.
- › Flat pack option available
- › Complies with IEC 60297 and EIA-310

Standard Inclusions

- › Cabinet frame
- › Front and rear mounting rails
- › RU labels on front rails only

Technical Specifications

Description:	RT2 Cabinet Frame Assembly 27RU 800w 600d
Cabinet Dimension:	1325h x 800w x 600d
Colour:	Ripple Black Gloss
Frame Weight:	28kg
Shipping Dimension:	1365h x 840w x 640d
Shipping Weight:	32kg (Note: weight of cabinet will vary according to selected doors, panels and accessories)

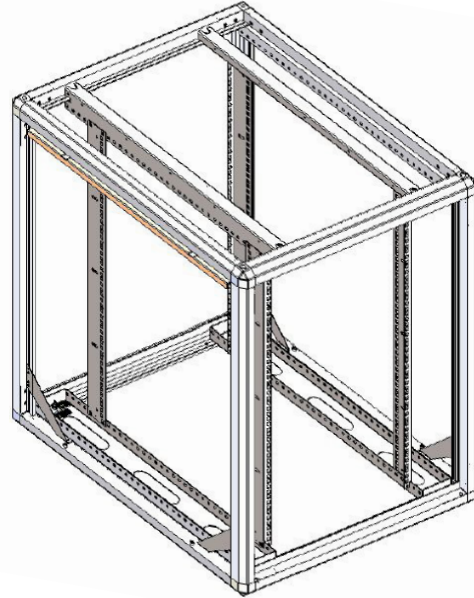

800w x 600d Frame Assembly

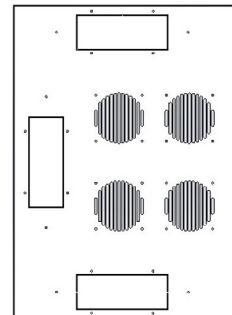

800w x 600d Top Panel



Typical RT2 Series frame with optional door and side panel

RT2 Series Custom Build Process



Part Numbers

To build your custom RT2 Series cabinet select the part numbers from the table below.

Frame 800w x 600d		Side Panel	Top Panel	Doors				
RU	Frame	Vented	Standard	Acrylic	Steel	Vented	Curved Vented	Bifold Vented
27RU	RT2705	RT2733	RT4585	RT2712	RT2722	RT2714	RT2714 – Curved	RT2714 – Bifold

Door Styles

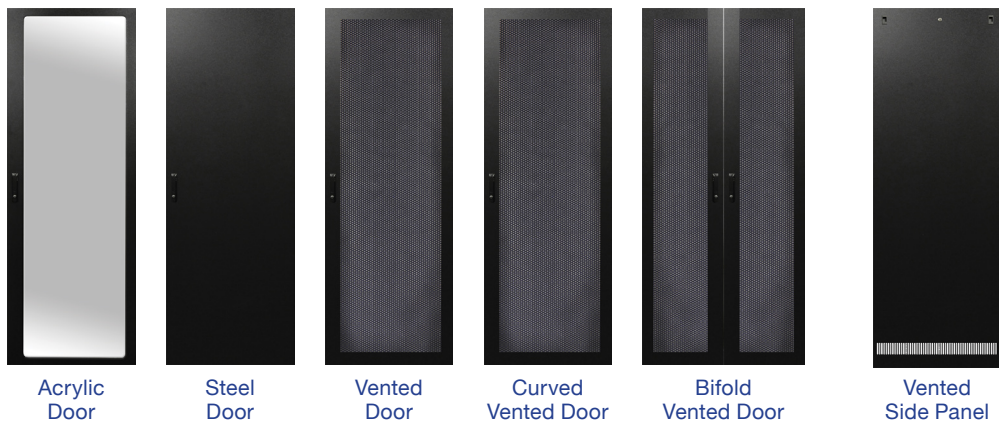

RT2 Series Features

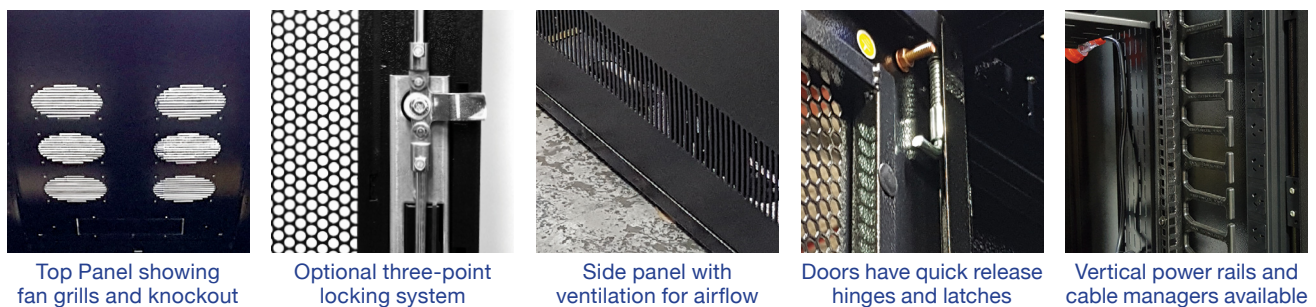

Information contained in this document is accurate at the time of preparation and is provided in good faith for general guidance. The information should not be used for detailed design or final specification as it is subject to change without notice. Please contact your local Racktech sales representative or the Racktech customer support team to obtain a copy of the current technical specifications. Images are for illustration purposes only.

March 2021