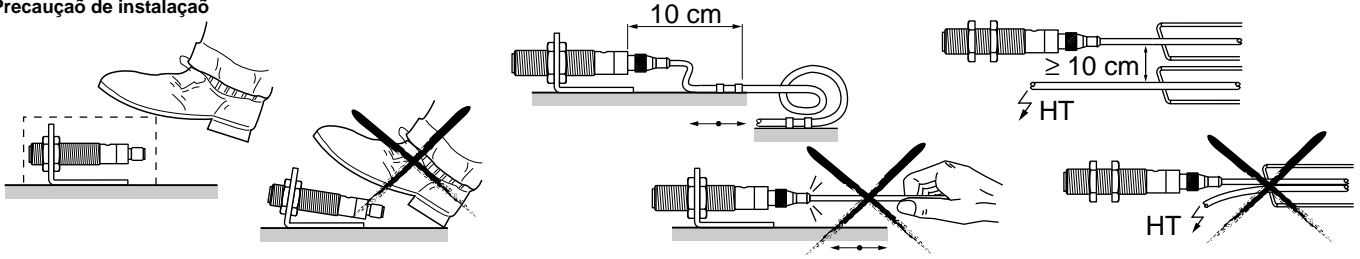
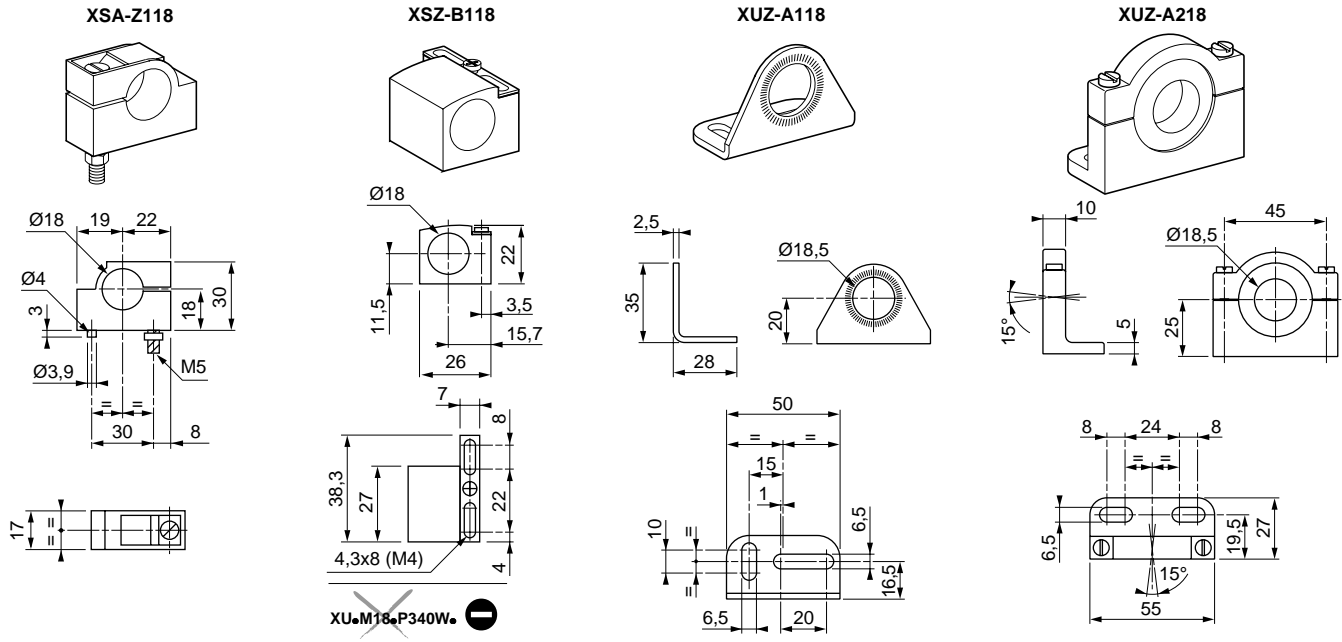


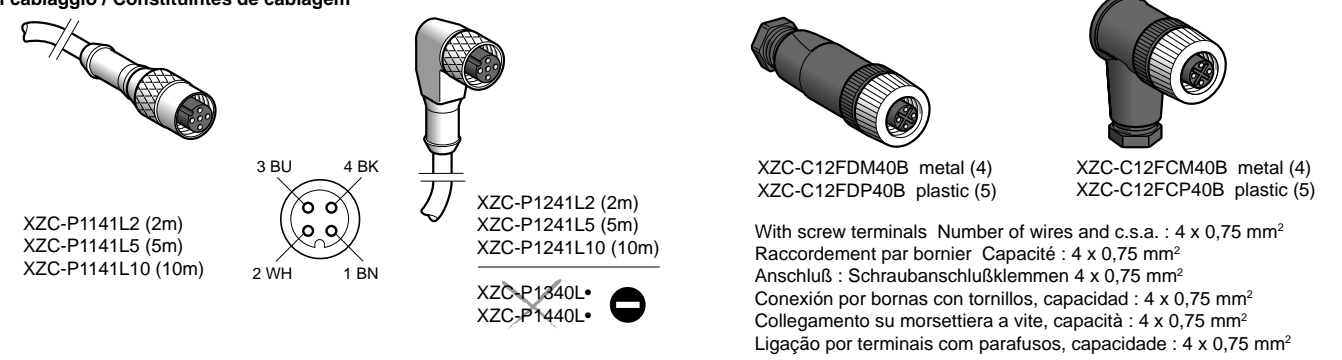
Installation precautions / Précautions de mise en œuvre / Vorsicht bei der Inbetriebnahme / Precauciones para la instalación / Consigli di messa in opera / Precaução de instalação



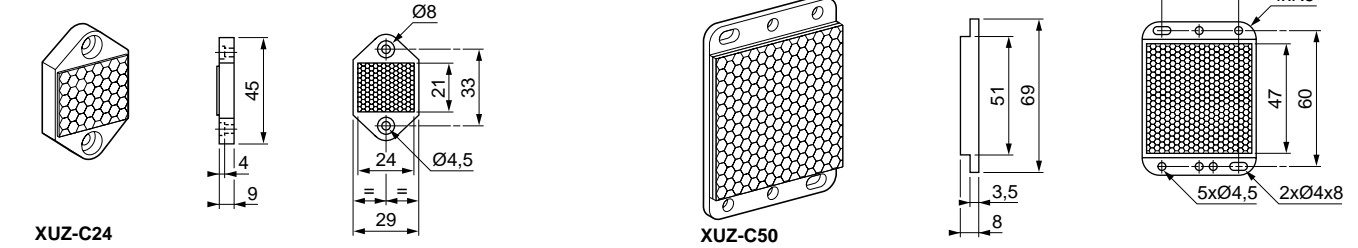
Fixing accessories / Accessoires de fixation / Befestigungszubehör / Accesorios de fijación / Accessori di fissaggio / Acessórios de fixação



Machine cabling accessories / Constituents de câblage machines / Zuberhör für Maschinen-Anschlußtechnik / Constituyentes de conexianado / Accessori di cablaggio / Constituintes de cablagem



Reflector / Réflecteur / Reflektor / Reflector / Catarifrangente / Reflector



- (1) Fonction claire / Hellschaltung / Función luz / Luce-on / Comutação clara
- (2) Programmation clair-sombre / Programmierung Hell-Dunkel / Programación luz-sombra / Programmazione chiaro-buio / Programação clara-sombra.
- (3) Ø du faisceau / Ø Lichtstrahl / Ø del haz / Ø del fascio / Ø do feixe.
- (4) métal / metall / metálico / metallica / metálica
- (5) plastique / Kunststoff / plástico / plastica / plástico

UL and CE Approvals:
 Applicable on proximity switches bearing the UL and CSA Listing marks only
 Enclosure : Type 12,4X indoor use only.

W915275380111 A08 2/2

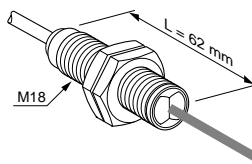


Osiris XU●-P18 / XU●-N18

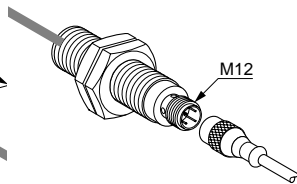


Photo-electric sensor M18, d.c. supply, solid state output
 Détecteur photoélectrique M18, alimentation en courant continu, sortie statique
 Photoelektronische Sensoren M18, Geräte für Gleichspannung, Ausgang : statisch
 Detectores fotoeléctricos M18, alimentación en corriente continua, salida estática
 Interruttori fotoelettrici M18, alimentazione in corrente continua, uscita statica
 Detectores foto-eléctricos M18, alimentação em corrente contínua, saída estática

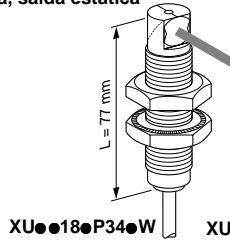
Max.tightening torque /
 Couple de serrage maxi. /
 Anzugsmoment maxi /
 Par de apriete máximo /
 Coppia di serraggio massima /
 Binário máximo de aperto



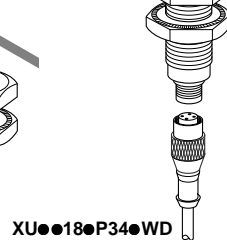
XU●-18●P34●



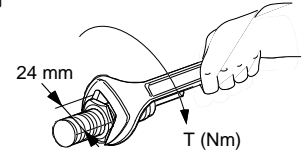
XU●-18●P34●D



XU●-18●P34●W



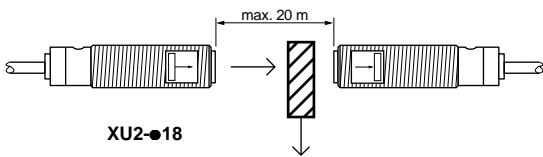
XU●-18●P34●WD



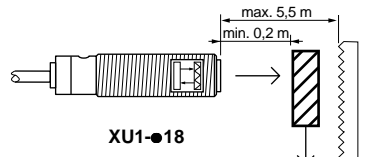
XU●N18 : T = 15 Nm
 XU●P18 : T = 5 Nm

Electrical installation / Mise en œuvre électrique / Elektrische Installation / Instalación eléctrica / Messa in opera elettrica / Instalação eléctrica

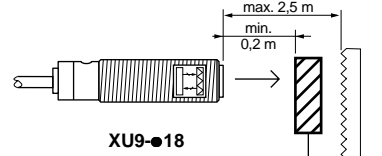
Light on (1)



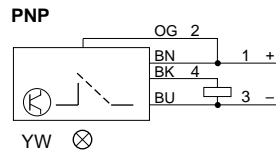
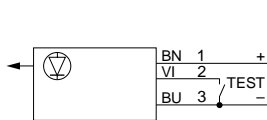
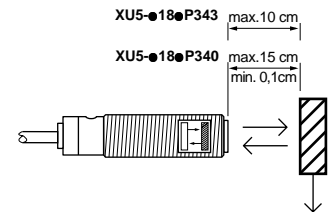
XU2-18



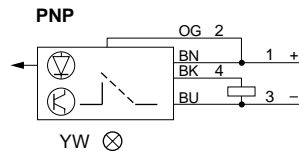
XU1-18



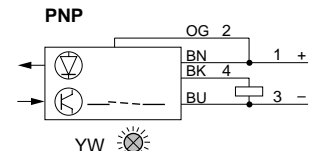
XU9-18



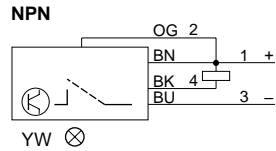
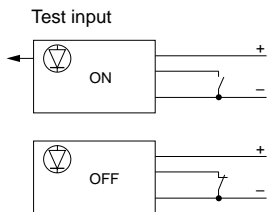
PNP



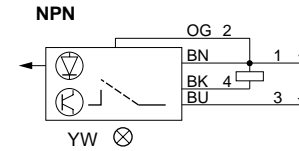
PNP



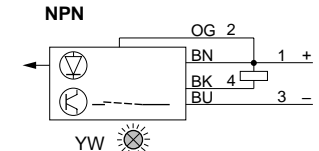
PNP



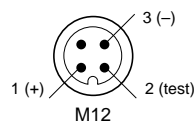
NPN



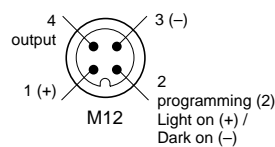
NPN



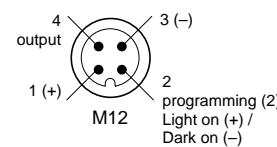
NPN



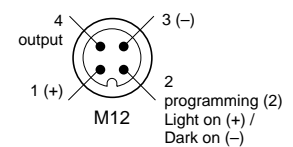
M12



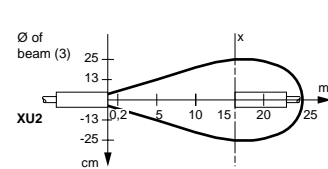
M12



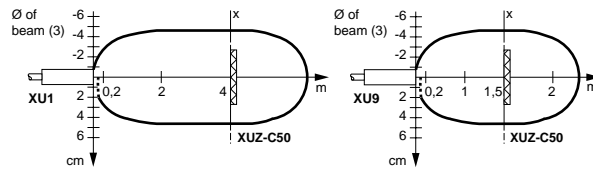
M12



M12

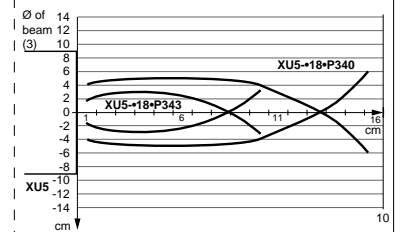


XU2



XU1

XU9



XU5-18●P340

XU5-18●P343

XU5

	YW	Yellow	Jaune	Gerb	Amarillo	Giallo	Amarelo
	BN	Brown	Brun	Brau	Marrón	Marrone	Castanho
	BU	Blue	Bleu	Blau	Azul	Blu	Azul
	BK	Black	Noir	Schwarz	Negro	Nero	Preto
	OG	Orange	Orange	Orange	Naranja	Arancio	Laranja
	WH	White	Blanc	Weiß	Bianco	Bianco	Branco
	VI	Violet	Violet	Violett	Violeta	Viola	Violeta

Voltage limits / limites de tension / Betriebsspannung / Límites de tensión / Limiti di rensione / Limite de tensão	10...30 V $\bar{\bar{=}}$
Load switching capacity / Courant commuté / Schaltstrom / Intensidad conmutada / Corrente commutata / Corrente comutada	\leq 100 mA
Current consumption / Puissance consommée / Leistung / Potencias consumida / Potenza consumata / Potenza consumida	\leq 30 mA (XU1/5/9) \leq 50 mA (XU2)
Maximum switching frequency / Fréquence maxi de commutation / Maximale Schaltfrequenz f / Frecuencia máxima de commutación / Frecuencia di commutazione max. / Frequência máxima de comutação	500 Hz

W915275380111 A08 1/2