

Lineryg

Distribution & Connection systems

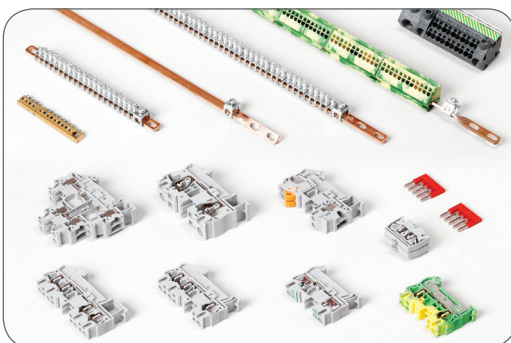
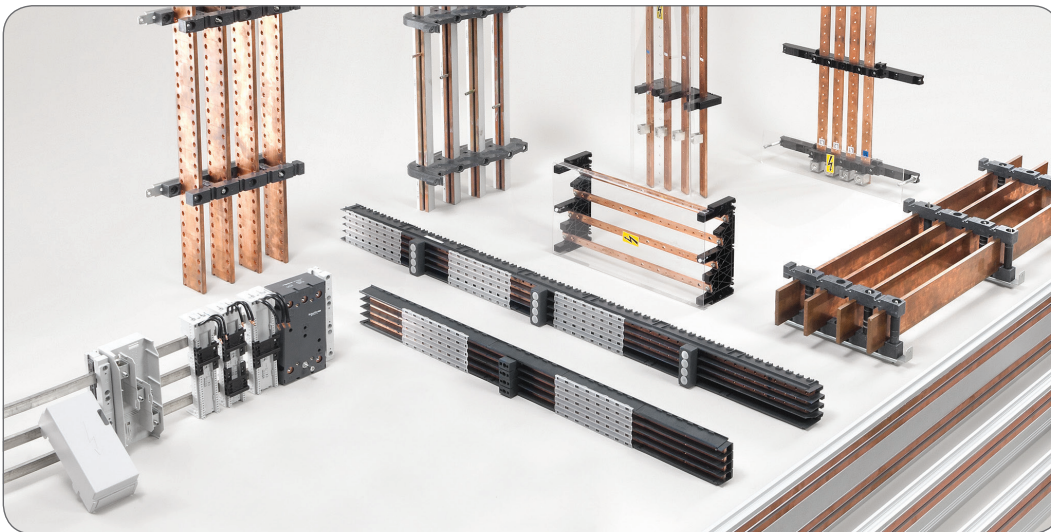
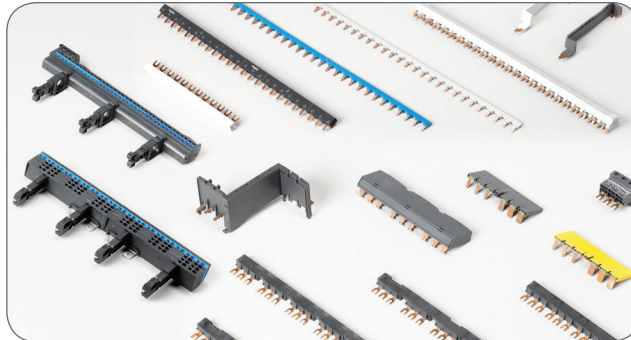
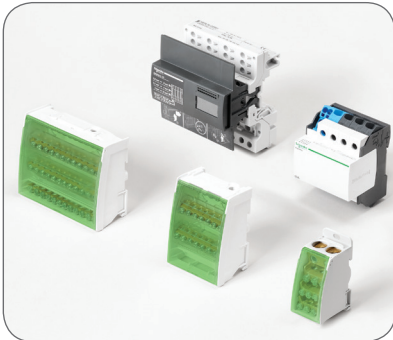

Presentation 4

Linery distribution systems

Distribution blocks 15

Device feeders 23

Power busbars 45

Hot plug busbar system 69

Linery connection systems

Terminal blocks & bars 75

Index of references 152



All Schneider Electric
distribution and connection
systems have now been
brought together into
a single brand name:

Linergy

Now, think Linery!



Because Linery is...



Flexible

- > **Linery** is a complete range of more than 800 references, suitable for all type of applications (electrical distribution, process and control, datacenters, etc.).
- > **Linery** can be easily adapted to technical demand, customer habits and preferences.
- > Thanks to their compactness, **Linery** products can be easily installed into a minimum of space.
- > **Linery** is easy to implement in the shortest possible time.
- > With **Linery** you can make changes to your panel on the installation site, right up to the last minute.



Safer

- > **Linery** IPxxB everywhere.
- > **Linery** is a "Hot plug" solution, enabling connections without turning off the switchboard (energised connection).
- > **Linery** simplifies wiring, thus directly contributing to enhancing panel reliability.



Reliable

- > **Linery** is fully compliant with IEC standards, and some systems are also multi-standard.
- > All **Linery** distribution and connection systems have been designed and tested to work together (synergies with Schneider Electric devices).
- > **Linery**, brings you the benefit of an energy-efficient switchboard.

And much more...



Linergy

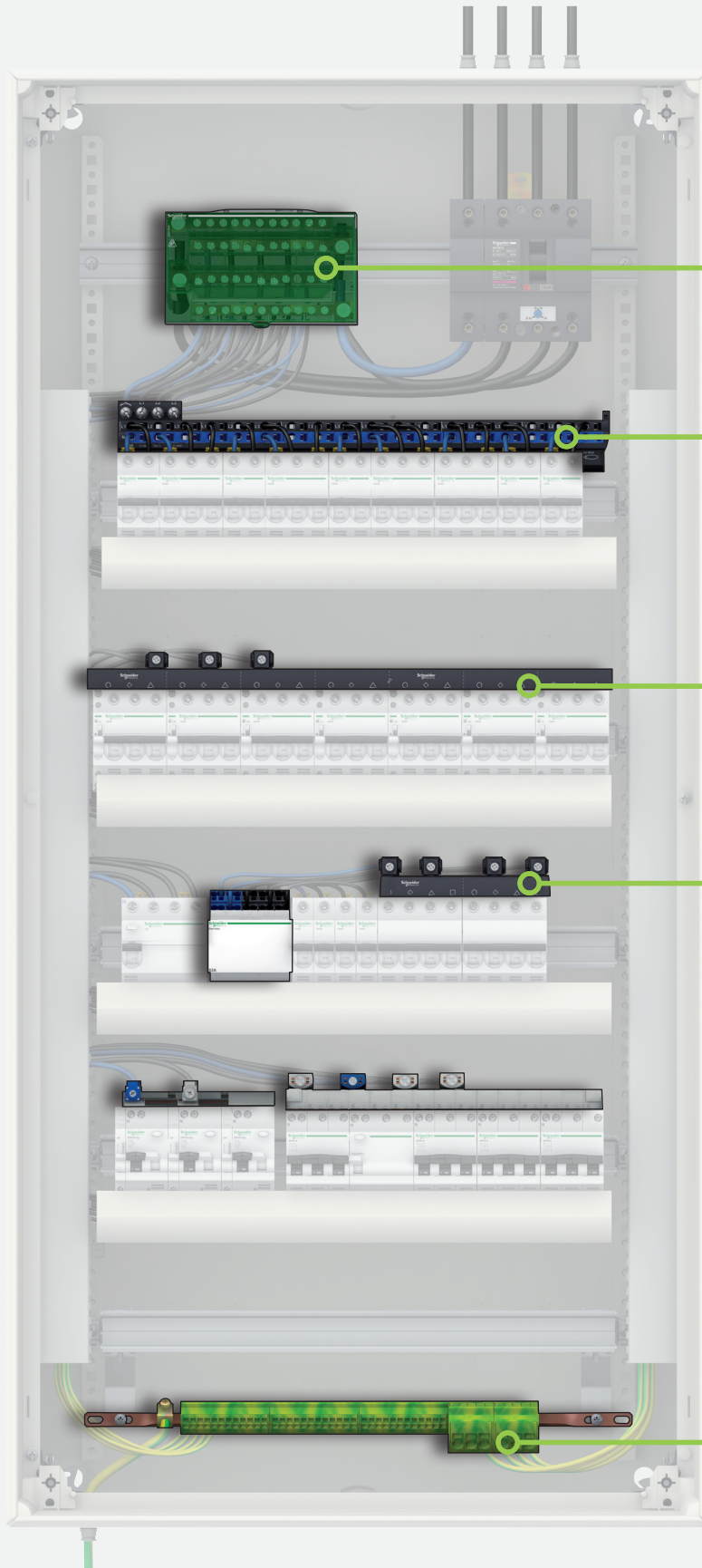

Inside Prisma and Spacial SFP, you benefit from IEC 61439 tested solutions

With Linergy, you will be able to connect your rows regardless of the enclosure you have chosen.

Linergy DS

Distribution Blocks



- > Compact solution
- > Cabling capacity of up to 60 connection points
- > Screw connection models

Linergy FM

Device Feeders



- > Quick distribution of up to 54 outgoing
- > Maximum flexibility to balance your phases
- > No creepage campaign thanks to clamp technology

Linergy FH

Device Feeders

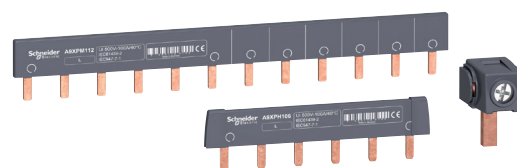

- > Complete family of products to cover all needs
- > Easy to install
- > Compactness up to 100 A

Linergy TB

Terminal Blocks and Bars

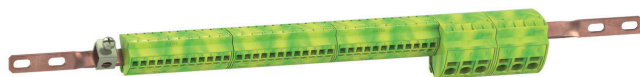

- > Minimum space required
- > Quick connection models

Linergy

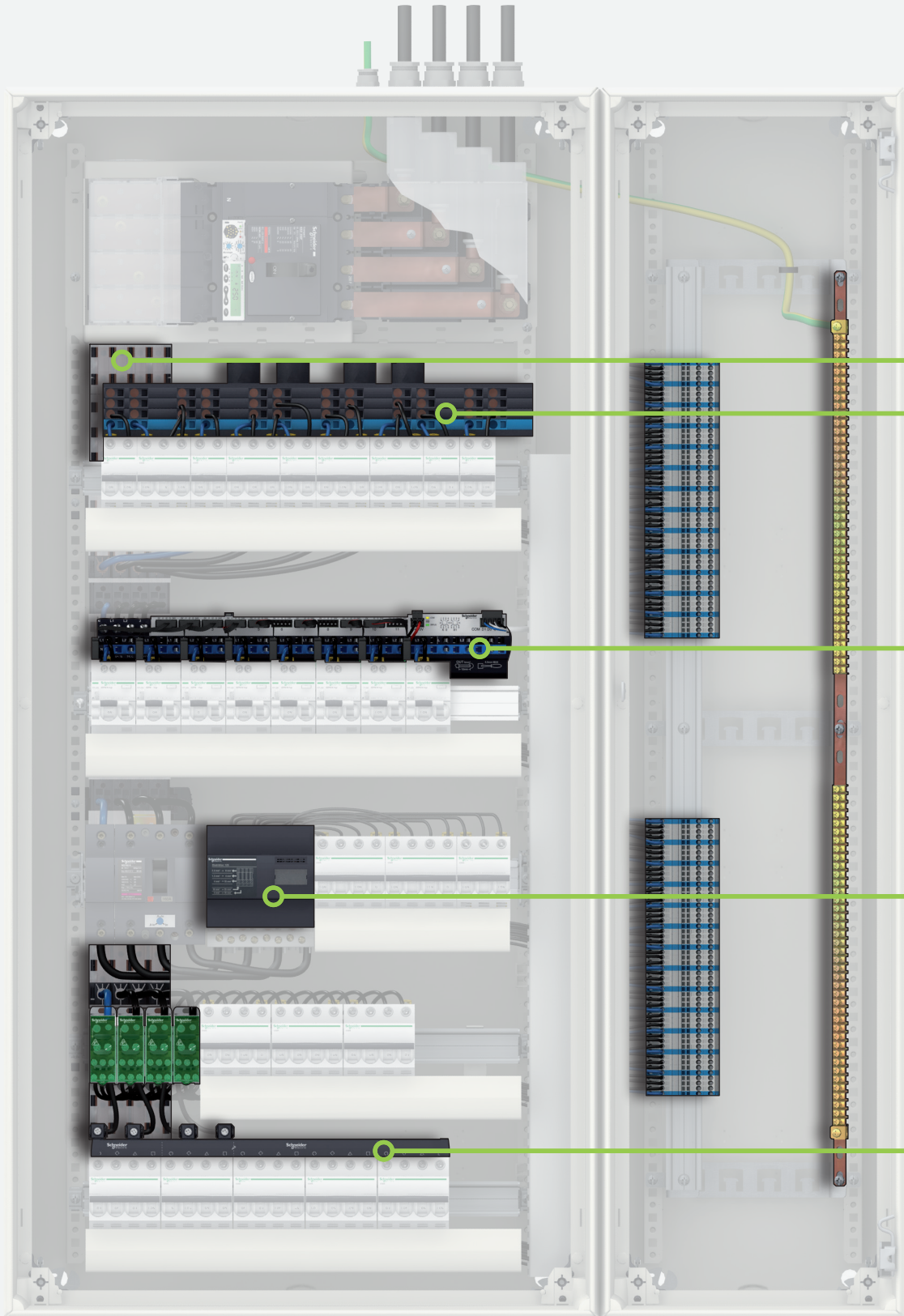
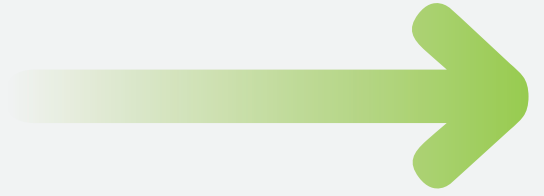

Lineryg offers you smart power network solutions for your switchboard.

Lineryg BW

Power Busbars



- > Solutions available up to 630 A
- > Solutions can be adapted to all switchboard architectures

Lineryg FM

Device Feeders



- > Maximum flexibility to balance your phases
- > SmartLink support for communication

Lineryg DX

Distribution Blocks



- > Quick connection models
- > Easy to wire
- > Compact solution
- > Cabling capacity of up to 52 connection points

Lineryg FH

Device Feeders

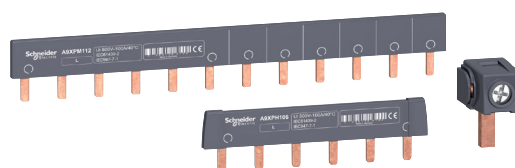

- > All lengths available (up to 1 m)
- > Comb busbars compatible with auxiliaries

Linergy

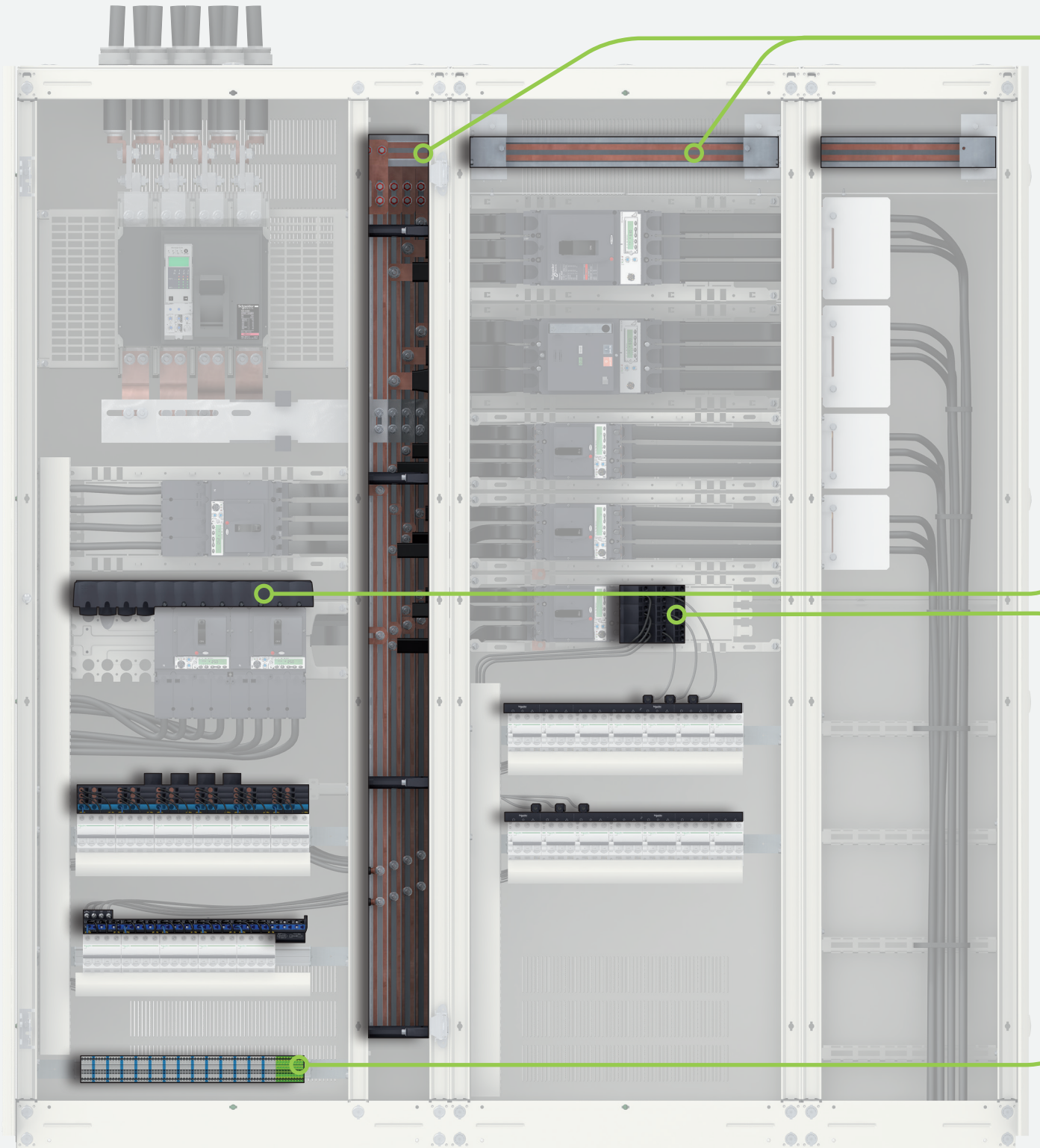

Lineryg also offers the most advanced busbar solutions while remaining simple.

Lineryg LGY/ LGYE

Power Busbars

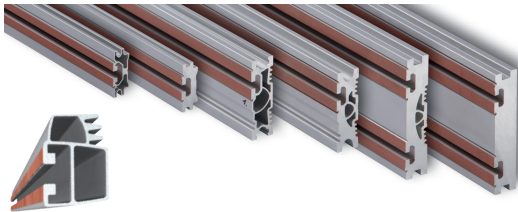

- > Solutions available up to 4000 A
- > Connection everywhere without drilling (with LGY and LGYE profile)

Lineryg FC

Device Feeders

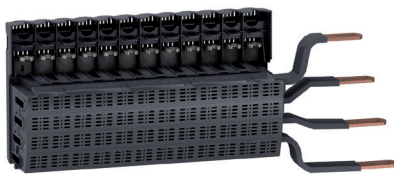

- > Compact NSXm (4 x 4P / 5 x 3P) solution
- > Compact NSX (3 x 4P / 4 x 3P) solution
- > Reliable connection
- > Quick connection system dedicated to Compact NSXm up to 160 A/ Compact NSX up to 250 A

Lineryg DP

Distribution Blocks

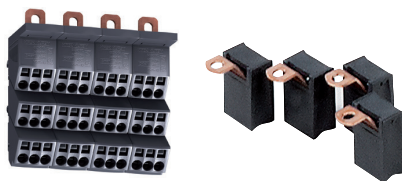

- > Simplicity of use
- > Quick connection system dedicated to Compact NSXm up to 160 A/ Compact NSX up to 250 A

Lineryg TR

Terminal Blocks and Bars

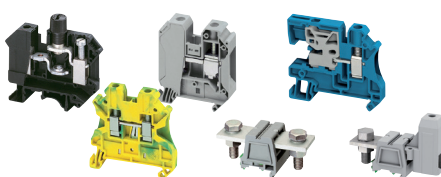

- > Simplicity of use
- > Consistency and cross-functionality guaranteed
- > Few references for a maximum of applications

Linergy

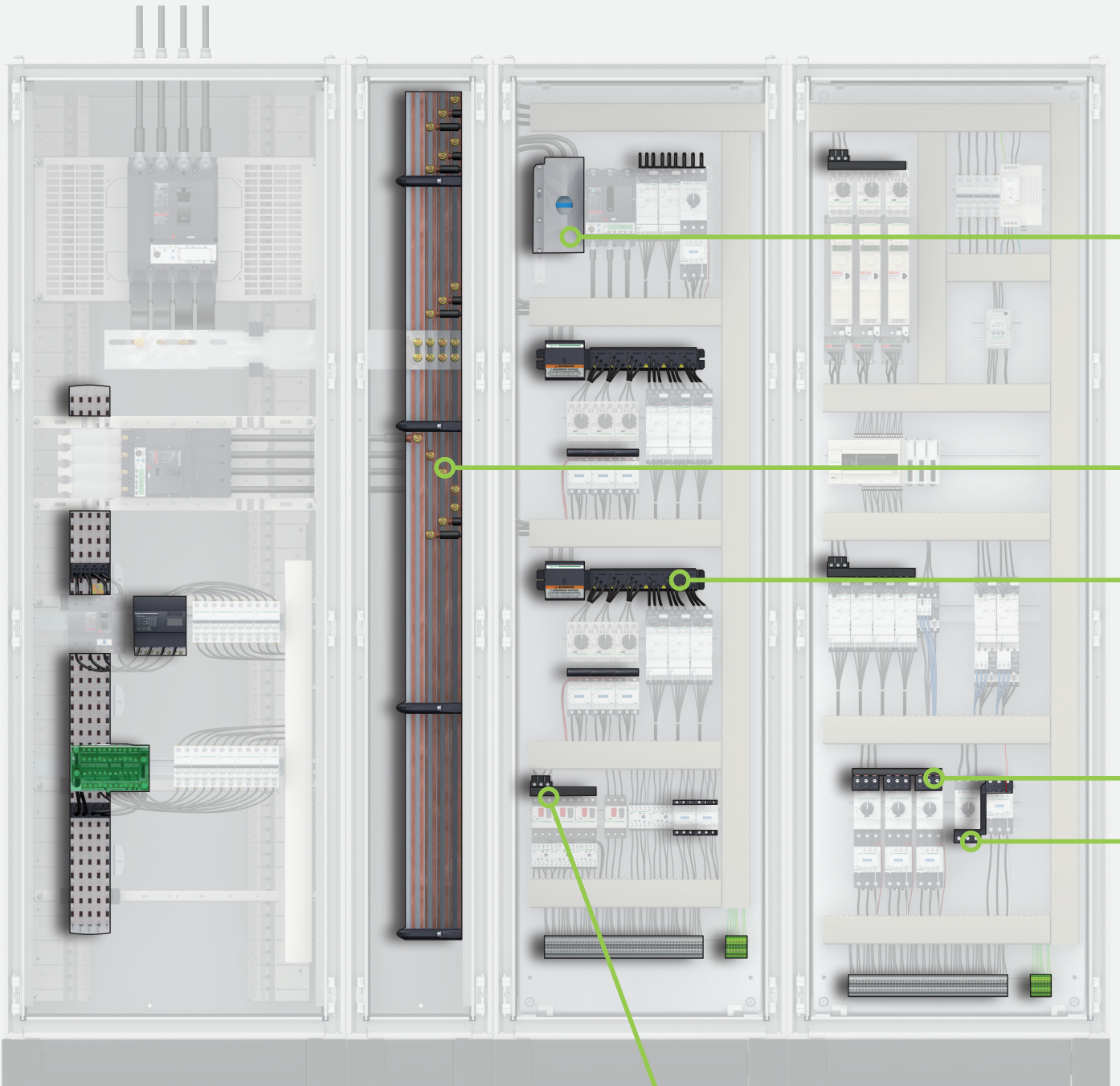
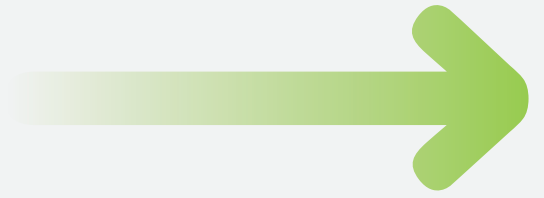

Thanks to Linergy, you can now have the scalable and flexible panel that you deserve.

Linergy BZ

Power Busbars

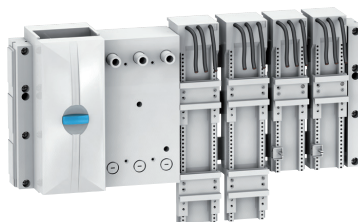

- > Quick connection plates for Compact and TeSys offers
- > Multi-standard offering up to 630 A

Linergy LGY / LGYE

Power Busbars

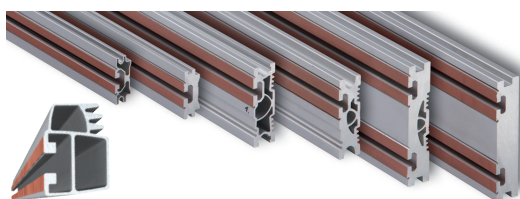

- > Solutions available up to 4000 A
- > Panel devices powered everywhere inside the panel

Linergy HK

"Hot Plug" Distribution



- > Panel easily upgradeable
- > Reliable "hot plug" modification or upgrade
- > Multi-standard system of up to 160 A

Linergy FT

Device Feeders

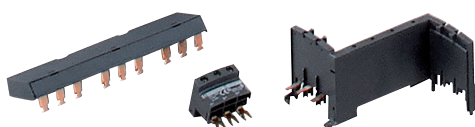

- > Optimised productivity and efficiency of your control panel
- > Easy to install
- > High reliability



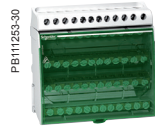

Linergy DS

16

Screw distribution blocks

16



Linergy DX

18

Quick distribution blocks

18

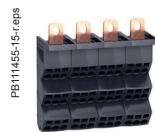

Linergy DP

20-21

Quick distribution blocks - Compact NSX and INS-INV up to 250 A

20

Quick distribution blocks - Compact NSXm up to 160 A

21



IEC/EN 60947-7-1, IEC/EN 61439-1 & 2





Description

- Single-pole or four-pole distribution block that can be installed on a standard DIN rail or on a mounting plate.
- Compatible with Prisma G and P, Pragma, Mini Pragma and Resbo series switchboards.
- Incomers and feeders are connected to screw terminals that accept rigid or flexible cables with ferrule.
- Optional: additional neutral terminal strip for four-pole distribution block.

Advantages

- Simplified power supply for main incomers.
- Easy phase balancing.
- Easy, effortless cabling due to excellent accessibility.
- Visible cabling.
- Insulation between phases.
- The single-pole distribution blocks are adjacent and bridgeable via the second incoming hole for parallel connection.

Screw distribution blocks

Number of poles	1P			4P
				
Rated operational current	125 A	160 A	250 A	100 A
Total connections capacity	10	13	14	4 x 7
Terminal capacity				
Diameter	2 x Ø 9.5 mm	2 x Ø 12 mm	1 x Ø 15.3 mm	2 x Ø 7.5 mm
	2 x Ø 7.5 mm	3 x Ø 7.5 mm	1 x Ø 10 mm	5 x Ø 5.5 mm
	6 x Ø 5.8 mm	8 x Ø 5.8 mm	4 x Ø 6 mm	-
	-	-	8 x Ø 7.5 mm	-
Rated peak withstand current (I _{pk})	25 kA	36 kA	60 kA	24 kA
Rated short-time withstand current (I _{cw}) (IEC/EN 60947-7-1)	4.2 kArms/1 s	8.4 kArms/1 s	14.4 kArms/1 s	3 kArms/1 s
Width (number of 9 mm pitches)	3	4	5	8
Dimension (H x W x D)	85 x 27 x 50.5	85 x 36 x 50.5	85 x 45 x 50.5	100 x 71 x 50.5
Weight (g)	125	163	239	210
Neutral terminal strip (optional)	-	-	-	LGYN1007
Reference	LG Y112510	LG Y116013	LG Y125014	LG Y410028



On LGY412560 and LGY416048 references
Input cabling facilitated by side terminals

Technical data

Common characteristics

Rated insulation voltage (Ui)	500 V AC
Rated operational voltage (Ue)	230 V AC (Ph/N) 440 V AC (Ph/Ph)
Rated impulse withstand voltage (Uimp)	8 kV
Rated conditional short-circuit current of an assembly	Up to the breaking capacity of Schneider Electric feeder circuit breakers, even in cascading configuration
Network frequency	50/60 Hz
Pollution degree	3
Overvoltage category	III

Additional technical characteristics

Reference temperature	40°C
Operating temperature	-25°C to 55°C
Dielectric withstand (IEC/EN 60947-1)	2500 V AC

			Neutral terminal strip		
125 A	160 A	100 A	125 A	100 A	15 A
4 x 12	4 x 15	4 x 12	7	12	15
1 x Ø 9 mm	1 x Ø 9.5 mm	1 x Ø 12 mm	2 x Ø 7.5 mm	1 x Ø 9 mm	1 x Ø 9.5 mm
7 x Ø 7.5 mm	3 x Ø 8.5 mm	3 x Ø 9 mm	5 x Ø 5.5 mm	7 x Ø 7.5 mm	3 x Ø 8.5 mm
4 x Ø 6.5 mm	11 x Ø 6.5 mm	8 x Ø 7.5 mm	-	4 x Ø 6.5 mm	11 x Ø 6.5 mm
-	-	-	-	-	-
26 kÅ	28 kÅ	36 kÅ	-	-	-
4.2 kArms/1 s	4.2 kArms/1 s	8.4 kArms/1 s	-	-	-
14	20	18	7	14	17
100 x 126 x 50.5	100 x 162 x 50.5	100 x 174 x 50.5	20 x 70 x 35	20 x 125 x 35	20 x 155 x 35
390	559	567	63	111	149
LGYN12512	LGYN12515	LGYN12512	-	-	-
LGY412548	LGY412560	LGY416048	LGYN1007	LGYN12512	LGYN12515

Terminal technical data

Type	PZ2 screw								
Diameter	Ø 5.5 mm	Ø 5.8 mm	Ø 6 mm	Ø 6.5 mm	Ø 7.5 mm	Ø 8.5 mm	Ø 9 mm	Ø 9.5 mm	
Section	Rigid cable	1.5 to 16 mm ²	1.5 to 16 mm ²	1.5 to 16 mm ²	1.5 to 16 mm ²	2.5 to 25 mm ²	6 to 35 mm ²	10 to 35 mm ²	
	Flexible cable or with ferrule	1.5 to 10 mm ²	1.5 to 10 mm ²	1.5 to 10 mm ²	1.5 to 10 mm ²	1.5 to 16 mm ²	4 to 25 mm ²	4 to 25 mm ²	
Tightening torque	2 N.m	2 N.m	2 N.m	2 N.m	2 N.m	2 N.m	2.5 N.m	2.5 N.m	
Type	Hc screw								
Diameter	Ø 9.5 mm	Ø 10 mm	Ø 12 mm	Ø 15.3 mm	-				
Section	Rigid cable	10 to 35 mm ²	1.5 to 50 mm ²	25 to 70 mm ²	35 to 120 mm ²				
	Flexible cable or with ferrule	6 to 35 mm ²	1.5 to 35 mm ²	16 to 50 mm ²	25 to 95 mm ²				
Tightening torque	8 N.m	4 N.m	1 P: 9 N.m	4 P: 5 N.m	14 N.m				

PB104499-7



PE500024





IEC 60947-7-1, IEC 61439-2

Description

- Downstream circuits are connected from the front, to spring terminals.
- Contact pressure automatically adapts to the size of the conductor.
- Contacts are insensitive to vibrations and thermal variations.
- Only one cable (flexible or rigid) can be inserted per terminal.

Quick distribution blocks



Number of poles		4P, incomers from top	4P, incomers from bottom
			
Rated operational current at 40°	(Ie)	63 A	63 A
Rated conditional short-circuit current of an assembly	(Isc)	The reinforced breaking capacity due to cascading in circuit breaker combinations is maintained. The worst-case situations have been tested.	The reinforced breaking capacity due to cascading in circuit breaker combinations is maintained. The worst-case situations have been tested.
Rated insulation voltage	(Ui)	500 V AC	500 V AC
Rated operational voltage	(Ue)	440 V AC	440 V AC
Rated impulse withstand voltage	(Uimp)	6 kV	6 kV
Rated short-time current Icw	(Icw)		
Rated operational frequency		50/60 Hz	50/60 Hz
Degree of protection		IPxxB	IPxxB
Incoming terminals		1 tunnel terminal 25 ² /ph	1 tunnel terminal 25 ² /ph
Total connection capacity, outgoing terminals		24 connections: 4 x 6 ² /phase 12 x 6 ² /neutral	24 connections: 4 x 6 ² /phase 12 x 6 ² /neutral
Dimensions (H x W x D)		96.5 x 72 x 62 8 x 9 mm pitch	96.5 x 72 x 62 8 x 9 mm pitch
Installation		Clipped onto a DIN rail	Clipped onto a DIN rail
Other			
Standard for installation inside Prisma		IEC 61439-2	IEC 61439-2
Glow-wire 60695-2-11		960°C	960°C
Degree of pollution		3	3
References		04040	04041

Accessories

References	-	-
------------	---	---

Advantages

- A reliable electrical connection, no maintenance required (tightness guaranteed over time).
- Quick connection.
- Easy phase balancing.
- Ease of rewiring if the switchboard is expanded or modified.

4P		1P	
			
125 A	160 A	160 A	
20 kA/60 ms max according to IEC 61439-1	20 kA/60 ms max according to IEC 61439-1	32 kA	
750 V	750 V	750 V	
690 VAC	690 VAC	690 VAC	
8 kV	8 kV	8 kV	
4.5 kA rms/1s	4.5 kA rms/1s		
50/60 Hz	50/60 Hz	50/60 Hz	
IPxxB	IPxxB	IPxxB	
1 tunnel terminal 35 ² /ph	1 tunnel terminal 35 ² /ph	1 tunnel terminal 70/ph	
52 connections: 7 x 4 ² /phase 3 x 6 ² /phase 2 x 10 ² /phase 1 x 16 ² /phase (screw terminal)	52 connections: 7 x 4 ² /phase 3 x 6 ² /phase 2 x 10 ² /phase 1 x 16 ² /phase (screw terminal)	6 connections: 6 x 16 ² /phase	
127 x 108 x 48 8 x 9 mm pitch	127 x 108 x 48 8 x 9 mm pitch	95 x 36 x 70 4 x 9 mm pitch	
Screwed to plain or slotted backplate or onto DIN rail	Screwed to plain or slotted backplate or onto DIN rail	Onto DIN rail	
Possible to combine 2 terminal blocks (2nd terminal block supplied from enclosed terminals in the 1st, I _{max} of 2nd terminal block: 80 A)	Possible to combine 2 terminal blocks (2nd terminal block supplied from enclosed terminals in the 1st, I _{max} of 2nd terminal block: 80 A)		
IEC 61439-2	IEC 61439-2	IEC 61439-2	
960°C	960°C	960°C	
3	3	3	
04045	04046	04031	
(4 x 125 A flexible connectors)		Copper spacer (batch of 4)	
04047		04037	

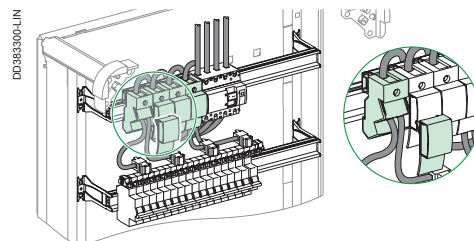
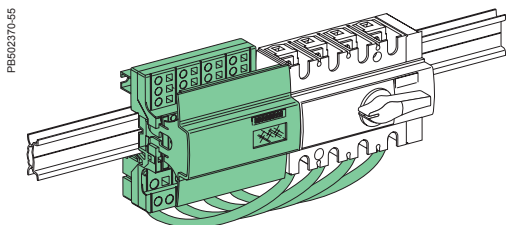

Lineryg DP

Quick distribution blocks - Compact NSX and INS-INV up to 250 A

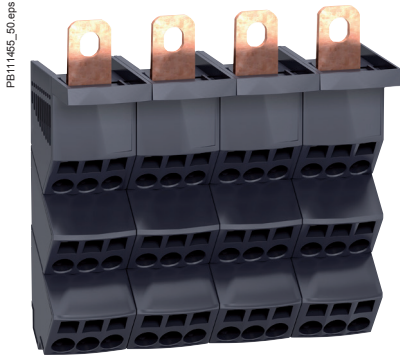



IEC 60947-7-1, IEC 61439-1 and 2

Description

■ The Lineryg DP Quick distribution block is designed for installation directly downstream of Compact NSX and INS-INV up to 250 A. It can also be clipped onto a modular rail.

Advantages

- It is quick to mount in the horizontal position. Electrical connections are made directly to the device terminals.
- It is the same width as the devices and does not take up any additional space in the switchboard.
- The connection terminals are slanted to facilitate cable entry and avoid exceeding the bending radius of the flexible and rigid cables.

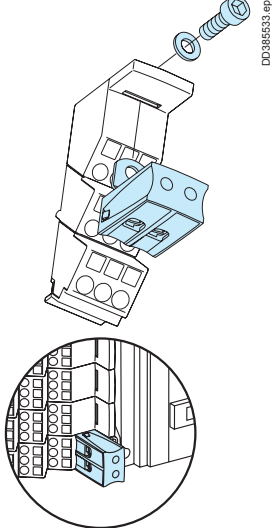
Quick distribution blocks for compact devices			Additional block	
Number of poles	3P	4P	3P/4P	
				
Rated operational current (Ie)	250 A	250 A	250 A	
Rated peak withstand current (Ipk)	32 kA	32 kA		
Rated short-time current with upstream protection of 150 kA Icc (Icc)	150 kA	150 kA		
Thermal stress (I ² .t)	7.225 x 10 ⁷	7.225 x 10 ⁷		
Total connection capacity, outgoing terminals	27 connections: 6 x 10 ² /phase 3 x 16 ² /phase	36 connections: 6 x 10 ² /phase 3 x 16 ² /phase	2 connections: 2 x 35 ² per pole	
Incomer terminals	1 cable lug 120 mm ² per pole			
Dimensions (H x W x D)	105 x 138 x 63	140 x 138 x 64		
Installation	On mounting plate or DIN rail		On mounting plate	
Product certifications	ASEFA			
Standard for installation inside Prisma	IEC 61439-1-2			
Glow-wire 60695-2-11	960°C			
References	04033	04034	04155 (3P) 04156 (4P)	

Technical Data	
Common characteristics	
Rated conditional short-circuit current of an assembly (Isc)	The reinforced breaking capacity due to cascading in circuit-breaker combinations is maintained. The worst-case situations have been tested.
Rated insulation voltage (Ui)	750 V AC
Rated operational voltage (Ue)	690 V AC
Rated impulse withstand voltage (Uimp)	8 kV
Network frequency	50/60 Hz
Degree of protection	IPxxB
Degree of pollution	3
Overvoltage category	III
Additional technical characteristics	
Reference temperature	40 °C
Operating temperature	-25 °C to 55 °C

Installation

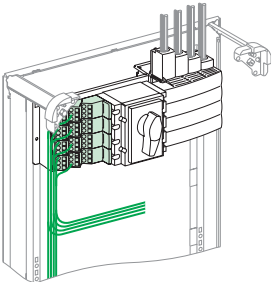

DD381346-70-LGI.eps

Directly on the mounting plates of horizontally mounted **Compact NSX100/250** and **Compact INS-INV250** devices in the enclosures.

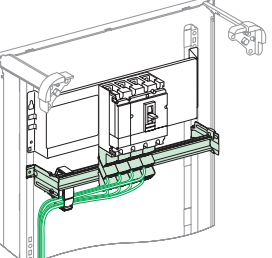

DD380760-70-LGI.eps

It can also be mounted downstream of vertically mounted **Compact NSX100/250** and **Compact INS-INV250** devices in the enclosures. In this case, the Lineryg DP is mounted on a depth-adjustable modular rail.

Linergy DP

Quick distribution blocks - Compact NSXm up to 160 A

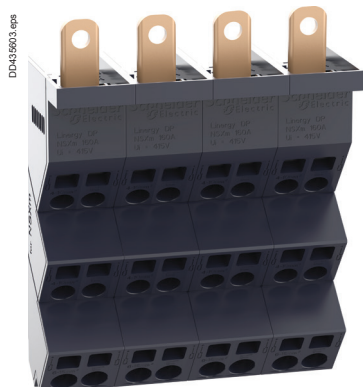

IEC 60947-7-1, IEC 61439-1 and 2

Description

■ The Linergy DP quick distribution block is designed for installation directly downstream of Compact NSXm up to 160 A. It can also be clipped onto a modular rail.

Avantages

- It is quick to mount in the horizontal position. Electrical connections are made directly to the device terminals.
- It is the same width as the devices and does not take up any additional space in the switchboard.
- The connection terminals are slanted to facilitate cable entry and avoid exceeding the bending radius of the flexible and rigid cables.

Quick distribution blocks for Compact devices

Number of poles	3P	4P
		
Rated operational current (Ie)	160 A	160 A
Rated peak withstand current (Ipk)	20 kA	20 kA
Rated short-time current (Icc)	70 kA	70 kA
Thermal stress (I ² .t)	4.7 x 10 ⁶ A ² S	4.7 x 10 ⁶ A ² S
Total connection capacity, outgoing terminals	18 connections: 4 x 10 ² /phase 2 x 16 ² /phase	24 connections: 4 x 10 ² /phase 2 x 16 ² /phase
Incomer terminals	1 cable lug 70 mm ² per pole	
Dimensions (H x W x D)	140 X 81 X 58 mm	140 X 108 X 58 mm
Installation	On mounting plate or DIN rail	
Product certifications	ASEFA	
Standard for installation inside Prisma	IEC 61439-1-2	
Glow-wire 60695-2-11	960 °C	
Catalogue numbers	04038	04039

Technical Data

Common characteristics

Rated conditional short-circuit current of an assembly (Isc)	The reinforced breaking capacity due to cascading in circuit-breaker combinations is maintained. The worst-case situations have been tested.
Rated insulation voltage (Ui)	800 V AC
Rated operational voltage (Ue)	690 V AC
Rated impulse withstand voltage (Uimp)	8 kV
Network frequency	50/60 Hz
Degree of protection	IPxxB
Degree of pollution	3
Overvoltage category	III

Additional technical characteristics

Reference temperature	40 °C
Operating temperature	-25 °C to 55 °C

Installation

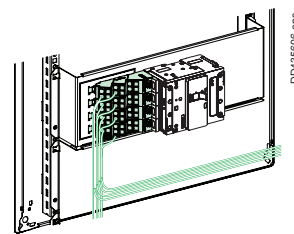

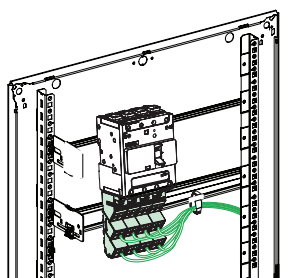

Directly on the mounting plates of horizontally mounted **Compact NSXm** devices in the enclosures.



It can also be mounted downstream of vertically mounted **Compact NSXm** devices in the enclosures. In this case, the Linergy DP is mounted on a depth-adjustable modular rail.

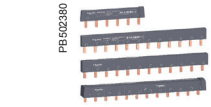

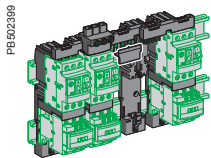
 <p>PB10A4505-50</p>	<h3>Linery FM</h3>	24
	Quick device feeders	24
 <p>PB50C2380</p>	<h3>Linery FH</h3>	26
	Horizontal comb busbar for 27 mm pitch for C120, NG125	26
	Horizontal comb busbar for 18 mm pitch for Acti 9 / Multi 9	27
	Horizontal comb busbar for 9 mm pitch for Acti 9, C60	29
	Horizontal comb busbar for 18 mm pitch for Domae	31
	Horizontal biconnect comb busbar for 18 mm pitch	32
 <p>PB50C2384</p>	<h3>Linery FV</h3>	33
	Vertical comb busbar	33
 <p>PB50S589</p>	<h3>Linery FC</h3>	34
	Feeders for Compact NSX and INS-INV up to 250 A	34
	Feeders for Compact NSXm up to 160 A	36
 <p>PB50C2389</p>	<h3>Linery FT</h3>	38
	Tesys comb busbar	38

IEC 60947-7-1, IEC 61439-2



Description

- Distribution over full rows of modular devices.
- The distribution block is generally supplied by busbars in enclosures and cubicles.
- Easy phase balancing.
- Mix of devices and functions in the same row.
- Installation ≥ 160 A: clipped onto the back of a modular rail or screwed onto a solid or pre-slotted plate.

Distribution blocks

Number of poles	4P	4P
Rated peak withstand current (I _{pk})	63 A	80 A
Rated conditional short-circuit current of an assembly (I _{sc})	15 kA	15 kA
Insulation voltage (U _i)	500 V AC	500 V AC
Rated voltage (U _e)	440 V AC	440 V AC
Rated impulse withstand voltage (U _{imp})	6 kV	6 kV
Maximum current (I _{max})	-	-
Rated operational frequency	50/60 Hz	
Degree of protection	IPxxB	IP20
Supply at incoming terminals	Enclosed terminals for cables up to 25 mm ²	Enclosed terminals for flexible cables 6 to 25 mm ² or rigid cables 10 to 35 mm ²
Total connection capacity at outgoing terminals	Spring terminals: 4 for each phase (2 x 1 to 4 mm ² + 2 x 1 to 6 mm ²) 8 for the neutral (4 x 1 to 4 mm ² + 4 x 1 to 6 mm ²)	Spring terminals for rigid or flexible cables without ferrule: 6 for each phase (1 to 6 mm ²) 18 for the neutral (1 to 6 mm ²)
Width	24 9-mm pitches 12 18-mm modules	48 9-mm pitches 24 18-mm modules
Composition	Stripped copper connections (L=100 mm) 10 x 4 mm ² + 6 x 6 mm ²	Stripped copper connections (L=105 mm) 6 mm ² (12 blue + 12 black)
References	04008	04000

Installation

	<p>Clipped onto the back of a modular rail, or screw fixing.</p>
	<p>Clipped onto the back of a modular rail, or screw fixing.</p>
	<p>Can be mounted in Pragma Evolution enclosures and in Prisma Pack 160</p>

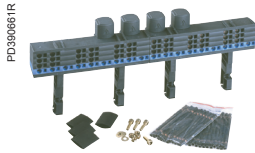

4P	2P	3P	4P	4P
160 A 27 kA	200 A 25 kA	200 A 25 kA	200 A 30 kA	200 A 27 kA
The cascading reinforced breaking capacity when combining circuit breakers is maintained. The worst-case scenarios have been tested.				
750 V AC	750 V AC	750 V AC	750 V AC	750 V AC
690 V AC	690 V AC	690 V AC	690 V AC	690 V AC
8 kV	8 kV	8 kV	8 kV	8 kV
50 A for feeder for 10 mm ² cable/63 A for feeder for 2 10 mm ² cables				
50/60 Hz				
IPxxB				
Direct onto the row by cable 50 mm ² with crimped lug, or flexible bar 20 x 3				
From Linergy BW insulated busbar in enclosure or cubicle with connection ref. 04021				
From Linergy BS sheathed busbar with connection ref. 04024				
From Linergy BS rear busbar with connection ref. 04029				
6 connection points for each phase 9 connection points for the neutral	12 connection points for the phase and the neutral	12 connection points for each phase 18 connection points for the neutral		
24 9-mm pitches 12 18-mm modules	48 9-mm pitches 24 18-mm modules		72 9-mm pitches 36 18-mm modules	
2 sachets with 12 stripped copper connections 10 mm ² (L=100 mm)				
Protective covers for power supply rows (IPxxB)				
Fixing accessories for power supply rows				
04018	04012	04013	04014	04026

Connections to the distribution block

4P 200 A connection (supplied with fixing accessories)	4P 200 A connection (supplied with fixing accessories)	4P 200 A connection (supplied with fixing accessories)	4P 160 A connection for Linergy FM 1/2 row
Allows power supply from Linergy BW busbar	Linergy BS sheathed busbar	Linergy BS rear busbar	Switchgear
References	04021	04024	04029

Spare parts

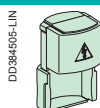

Reference	4 covers for 160/200 A Linergy FM rows
	01202

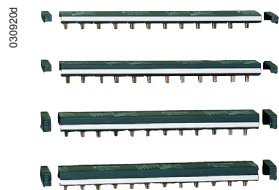

IEC 60664-1

Description

Comb busbars make it easier to install Schneider Electric products.

- Supplied with 2 side plates, IP 2
- Outgoing feeders can be marked
- Cutting markings on the copper bars and the insulating material

C120, NG125		27 mm poles, cuttable			
Number of poles		1P	2P	3P	4P
	030920d				
		Supplied with 2 side plates, IP2 and 4 tooth cover end-pieces Outgoing feeders can be marked Cutting markings on the copper bars and the insulating material Unused teeth can be insulated with tooth covers			
Rated operational current at 40°C	(Ie)	125 A			
Rated conditional short-circuit current of an assembly	(Isc)	Compatible with the breaking capacity of Schneider Electric circuit breakers			
Insulation voltage	(Ui)	620 V			
Rated voltage	(Ue)	500 V			
Fire resistance to IEC 695-2-1		Self-extinguishing 960°C 30 s			
Colour		RAL 7016 (anthracite grey)			
Use					
		Power supply by connector recommended			
Number of 27 mm modules		16	16	15	16
Set of		1			
References		14811	14812	14813	14814

Installation

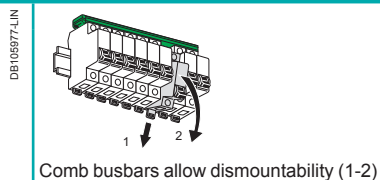

Accessories

Number of poles	1P, 2P, 3P, 4P	
	PG134071	030921d
	Tooth covers	Insulated connector
		Compatible with all Schneider Electric comb busbars Clip onto the comb busbar's insulating material, which gives them very great stability Receive clip-on markers allowing circuit identification
Use		
		For 25 mm ² semi-rigid cable
Set of	20	4
References	14818	14885

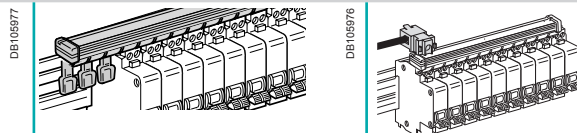

IEC 60947-7-1, IEC 61439-2

PB602379

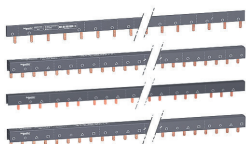

Description

Comb busbars make it easier to install Schneider Electric products.

- Can be sawn and cut in a single pass
- Supplied with two IP20 lateral end-pieces except for 57 module references
- The end-pieces are compulsory after cutting
- The phases are identified by symbols on each side of the comb busbar for installation in all positions
- Cutting marks on the insulating material
- The special comb busbars for circuit breakers with 9 mm auxiliaries have a 9 mm gap for inserting iOF and iSD

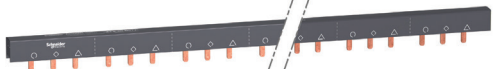
Acti 9 / Multi 9		18 mm poles, cuttable										
Number of poles		1P	2P	3P	4P	3 (N+P)	Aux+1P	Aux+2P	Aux+3P	Aux+4P	3 (Aux+1P)	3 (Aux+N+1P)
	PB110252-24											
Rated operational current at 40°C (Ie)		100 A										
Rated conditional short-circuit current of an assembly (Isc)		Compatible with the breaking capacity of Schneider Electric circuit breakers										
Insulation voltage (Ui)		500 V										
Rated voltage (Ue)		415 V										
Fire resistance to IEC 695-2-1		Self-extinguishing 960°C 30 s										
Colour		RAL 7016 (anthracite grey)										
Use												
Power supply by connector recommended												
Type		L1...	L1L2...	L1L2L3...	NL1L2L3...	NL1NL2... ...NL3	AuxL1...	AuxL1L2...	AuxL1L2L3	AuxNL1... ...L2L3	AuxL1... ...AuxL2... ...AuxL3	AuxL1... ...AuxL2... ...AuxL3
Set of		1	1	1	1	1	1	1	1	1	1	1
References												
6 modules of 18 mm		A9XPH106	-	-	-	-	-	-	-	-	-	-
12 modules of 18 mm		A9XPH112	A9XPH212	A9XPH312	A9XPH412	A9XPH512*	-	-	-	-	-	-
18 modules of 18 mm		-	-	-	-	A9XPH518*	-	-	-	-	-	-
24 modules of 18 mm		A9XPH124	A9XPH224	A9XPH324	A9XPH424	A9XPH524*	-	-	-	-	-	-
57 modules of 18 mm		A9XPH157	A9XPH257	A9XPH357	A9XPH457	A9XPH557*	A9XAH157	A9XAH257	A9XAH357	A9XAH457	A9XAH657	A9XAH557*

* This comb busbar is only compatible in top feeding for simple lug devices and bottom feeding on double lug devices.

Installation





PB110290-40



PB110793-40



Accessories

Number of poles	1P	2P	3P	4P	-	-	-	
	DB404806				DB404806		PB110259-15 	PB110259-22 
	End-pieces				Tooth covers		Connectors	
	Lateral end-pieces providing IP20 protection				Insulate teeth that have been left free		Monoconnect Double terminals Comb busbar power supply. Horizontal incomer on each side. For 35 mm ² cable. Tightening torque 4 N.m	
								
Set of	10	10	10	10	20	4	4	
References	A9XPE110	A9XPE210	A9XPE310	A9XPE410	A9XPT920	A9XPCM04	A9XPCD04	

IEC 60947-7-1, IEC 61439-2

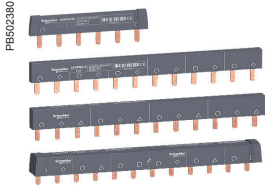

Description

Comb busbars make it easier to install Schneider Electric products. The phases are identified by symbols on each side of the comb busbar. Dismountability of devices with Acti 9.

Acti 9 / Multi 9		18 mm poles, not cuttable				
Number of poles		1P	2P	3P	4P	3 (N+P)
	PB110231-15					
Rated operational current at 40°C (Ie)		100 A				
Rated conditional short-circuit current of an assembly (Isc)		Compatible with the breaking capacity of Schneider Electric circuit breakers				
Insulation voltage (Ui)		500 V				
Rated voltage (Ue)		415 V				
Fire resistance to IEC 695-2-1		Self-extinguishing 960°C 30 s				
Colour		RAL 7016 (anthracite grey)				
Use						
Type		Power supply by connector recommended				
Set of		L1	L1L2	L1L2L3	NL1L2L3	NL1NL2NL3
		1	1	1	1	1
References						
12 modules of 18 mm		A9XPM112	A9XPM212	A9XPM312	A9XPM412	A9XPM512*

* This comb busbar is only compatible in top feeding for simple lug devices and bottom feeding on double lug devices.

Installation

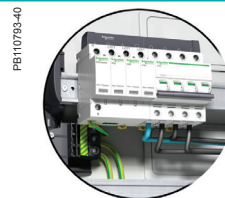
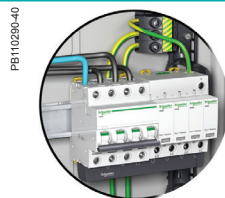

Accessoires

	PB110230-40		PB110232		PB110235	
		Cache-dents		Connecteurs		
		Isoler les dents libres		Bornes doubles		Monoconnexion
				Peigne d'alimentation		
Utilisation						
				Arrivée horizontale de chaque côté Pour câble de 35 mm ² Couple de serrage 4 N.m.		
Ensemble de	20		4		4	
Références	A9XPT920		A9XPCD04		A9XPCM04	
Installation						

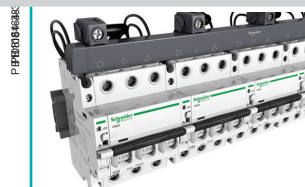

IEC 60439-1



Description

Comb busbars ensure:

- Easy, reliable mounting of 1P+N and 3P+N, TL, CT, ID, V, BP and Cm switchgear: tooth positioning opposite the device terminals is ensured by indexing of copper parts
- C60/ID Group Feeder comb busbars contain two different parts:
 - Connection of Group Feeder switchgear: C60 (3P+N) or ID (3P+N) circuit breaker in 18 mm modules, powered by cables, through the bottom, directly by the terminals
 - Connection of Clario, Prodis and Libro switchgear in 9 mm modules

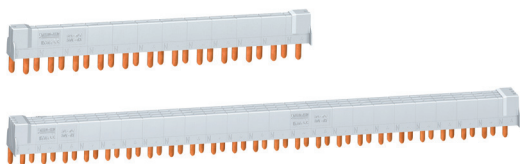
PB502382



Acti 9 Ph+N		9 mm poles, cuttable					
Number of poles		1P+N			3P+N		
							
		21501			21505		
		Complete comb busbars (supplied with 4 side plates and 1 tooth cover)					
Rated operational current at 40°C (Ie)		80 A					
Rated conditional short-circuit current of an assembly (Isc)		Compatible with the breaking capacity of Schneider Electric circuit breakers					
Insulation voltage (Ui)		440 V					
Rated voltage (Ue)		230 V (P4 + N) - 400 V (3Ph + N)					
Rated impulse withstand voltage (Uimp)		6 kV					
Degree of protection		IP20					
Fire resistance to IEC 695-2-1		Self-extinguishing 960°C 30 s					
Colour		RAL 7035					
Number of 18 mm modules	Comb busbar	12	18	24	12	18	24
	Tooth cover	3	3	6	3	3	6
References		21501	19512	21503	21505	09516	21507
Comb busbars alone							
Number of 18 mm modules	Comb busbar	48			48		
References		21089			21093		

C60/ID Group Feeder comb busbars alone		3P+N		
Number of poles				
Rated operational current at 40°C (Ie)		80 A		
Rated conditional short-circuit current of an assembly (Isc)		Compatible with the breaking capacity of Schneider Electric circuit breakers		
Insulation voltage (Ui)		440 V		
Rated voltage (Ue)		230 V (P4 + N) - 400 V (3Ph + N)		
Rated impulse withstand voltage (Uimp)		6 kV		
Degree of protection		IP20		
Fire resistance to IEC 695-2-1		Self-extinguishing 960°C 30 s		
Colour		RAL 7035		
Number of 18-mm modules		12	48	48
Power supply		Through left-hand	Through left-hand	Through right-hand
References		10545	10546	10547

Accessories				
Number of poles	1P+N	3P+N		
				
	End-pieces	Tooth covers (3 x 18-mm modules)	Tooth covers (1 x 18-mm module)	Connectors (grey)
Set of	40	12	10	4
References	021094	021095	010405	021098

IEC 60439-1

PB02383

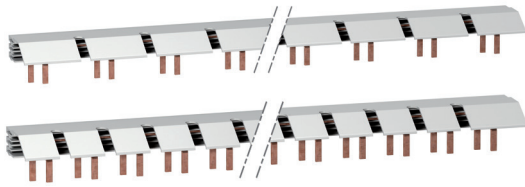

Description

- Connection of Clario, Prodis and Libro switchgear in 9 mm modules
- The special comb busbars for circuit breaker have a gap of 9 mm for inserting OF, SD, OF-SD/OF auxiliaries
- The comb busbars for 3P+N circuit breakers and auxiliaries are compatible with Prisma switchboard
- 1P+N comb busbars with Prisma and Pragma 24

Acti 9		9 mm poles, cuttable			
Number of poles		1P+N	3P+N	1P+N	3P+N
		A9N21036			
		Comb busbars		Comb busbars DPN Vigi	
Rated operational current at 40°C (Ie)		63 A			
Rated conditional short-circuit current of an assembly (Isc)		Compatible with the breaking capacity of Schneider Electric circuit breakers			
Insulation voltage (Ui)		500 V			
Rated voltage (Ue)		230 V (P4 + N) - 400 V (3Ph + N)			
Degree of protection		IP20			
Fire resistance to IEC 695-2-1		Self-extinguishing 960°C 30 s			
Colour		RAL 7035			
Number of 18-mm modules		56	56	56	56
References		A9N21035	A9N21036	A9N21037	A9N21038

Accessories					
Number of poles	1P+N	3P+N			
	End-pieces		Connectors (grey)		Neutral connectors (blue)
Set of	20		10	10	10
References	A9N21039	A9N21040	A9N21041	A9N21042	A9N21050

IEC 60439-1, IEC60664

PB101625-35

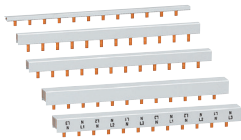

Description

Comb busbars:

- Ensure easy reliable mounting of switchgear: tooth positioning opposite the device terminals is ensured by indexing of copper parts.
- Can be sawn and cut.
- Are supplied with two IP20 lateral end-pieces (the end-pieces are compulsory).
- Unused teeth can be insulated with tooth covers.

Domae		18 mm poles, cuttable								
Number of poles		1P	2P	3P	4P	L1N/L2N/L3N				
Rated operational current at 40°C (Ie)		63 A								
Rated conditional short-circuit current of an assembly (Isc)		Compatible with the breaking capacity of Schneider Electric circuit breakers								
Insulation voltage (Ui)		500 V								
Rated voltage (Ue)		Ph/N 230 V AC								
		Ph/Ph 400 V AC								
Fire resistance to IEC 695-2-1		Self-extinguishing 850°C 30 s								
Colour		RAL 7035								
Power supply		By 16 mm ² semi-rigid or 10 mm ² flexible cable								
		With connector								
Number of 18 mm modules		12	57	12	57	12	57	12	57	57
References		10387	10388	10389	10390	10391	10392	10393	10394	10395

PB502372

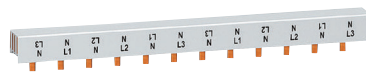

Installation	

PB101630_SE-40

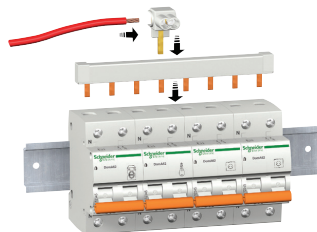

Accessories					
Type	Connectors (4, 35 mm ²)	End-pieces (2 phases)	End-pieces (3 phases)	End-pieces (4 phases)	Tooth covers
Set of	1	10	10	10	10
References	10397	10398	10399	10405	10396

PB502373

PB101632-10

PB502376

PB110396

Linery FH

Horizontal biconnect comb busbar for 18 mm pitch

PB602361

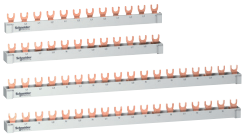

IEC60664-1

Description

Distribution and sub-distribution of the electric power supply
Fast assembly and disassembly of connected devices

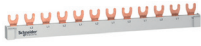
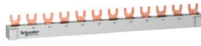
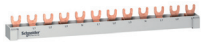
Horizontal biconnect comb busbar		18 mm poles, cuttable											
Number of poles		1P 			2P 			3P 			4P 		
Rated operational current at 40°C (Ie)		63 A											
Rated conditional short-circuit current of an assembly (Isc)		Compatible with the breaking capacity of Schneider Electric circuit breakers											
Insulation voltage (Ui)		500 V											
Rated voltage (Ue)	Ph/N	230 V AC											
	Ph/Ph	400 V AC											
Fire resistance to IEC 695-2-1		Self-extinguishing 960°C 30 s											
Colour		RAL 7035 (grey)											
Use													
		Power supply: into box lug (25 mm ² rigid or 16 mm ² flexible) or by connector (35 mm ² rigid or 25 mm ² flexible with ferrule)											
Type		L1			L1L2			L1L2L3			L1L2L3L4		
Number 18 mm, modules		12	18	57	12	18	57	12	18	57	12	18	57
Set of		1	1	1	1	1	1	1	1	1	1	1	1
References		R9XFH112	R9XFH118	R9XFH157	R9XFH212	R9XFH218	R9XFH257	R9XFH312	R9XFH318	R9XFH357	R9XFH412	R9XFH418	R9XFH457

Installation

DB405995





Horizontal biconnect comb busbar		18 mm poles, cuttable												
Number of poles		4P 												
Rated operational current at 40°C (Ie)		63 A												
Rated conditional short-circuit current of an assembly (Isc)		Compatible with the breaking capacity of Schneider Electric circuit breakers												
Insulation voltage (Ui)		500 V												
Rated voltage (Ue)	Ph/N	230 V AC												
	Ph/Ph	400 V AC												
Fire resistance to IEC 695-2-1		Self-extinguishing 960°C 30 s												
Colour		RAL 7035 (grey)												
Use														
Type		NL1L2L3L4 - NL1NL2NL3						NL1NL2NL3						
Number 18 mm, modules		18						18						57
Set of		1						1						1
References		R9XFH518G						R9XFH518						R9XFH557

Installation

DB405995



Accessories							
Number of poles	1P	2P	3P	4P			
							
	End-pieces				Tooth covers		Connectors
Set of	10				20		4
References	R9XE110	R9XE210	R9XE310	R9XE410	R9XT20	R9XFC04	

PB502384



IEC 60664-1

Description

Provide a 2P supply to the main incomers from one row to the next:

- Centre line between rows: 125 mm or 150 mm
- Distances between terminals: 9 mm or 18 mm pitch

Vertical comb busbars

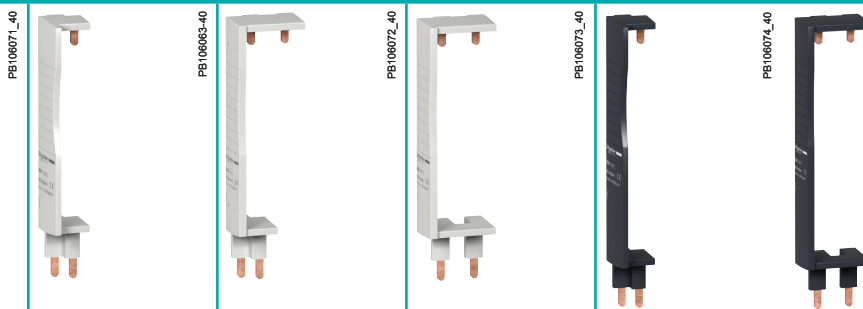

	Direct power supply to circuit breaker or residual current circuit breaker terminals					
Rated operational current at 40°C (Ie)	80 A					
Rated conditional short-circuit current of an assembly (Isc)	Compatible with the breaking capacity of Schneider Electric circuit breakers					
Insulation voltage (Ui)	500 V					
Rated voltage (Ue)	415 V					
Fire resistance to IEC 695-2-1	Self-extinguishing 850°C 30 s					
Distance between upstream terminals	9 mm	18 mm	18 mm	9 mm	18 mm	
Distance between downstream terminals	9 mm	9 mm	18 mm	9 mm	18 mm	
Centre line between rows	125 mm			150 mm		
Colour	RAL 7035 (light grey)			RAL 7016 (anthracite grey)		
References	14900	14909	14910	14901	14911	

Installation

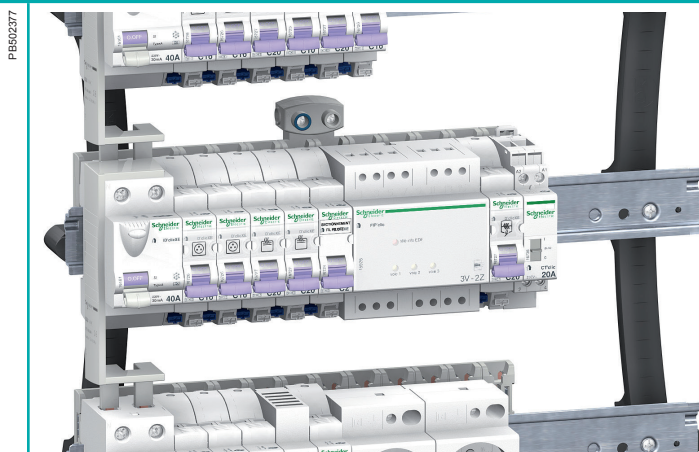

PB502377

Lineryg FC

Feeders for Compact NSX and INS-INV up to 250 A

IEC 61439-1 and 2

Description

Lineryg FC is an insulated horizontal distribution block. It connects directly to the mounting plate and can supply:

- Three 4P and four 3P Compact NSX circuit breakers, whatever the ratings (100, 160 or 250 A), the operating systems (toggle, rotary handle, motor mechanism), whether fixed or plug-in, front or rear connection (the circuit breakers must be equipped with long terminal shields downstream)
- Three 4P or four 3P Compact INS-INV switch-disconnectors, whatever the ratings (100, 160 or 250 A), whether front or rear connection.
- The design and small size blend perfectly with the devices.
- It can be supplied by Lineryg BS or Lineryg LGY busbars positioned to the left or right.
- Fully insulated, Lineryg FC contributes to the safety of life and property. Numerous and well distributed vents ensure natural convection and optimum cooling of the conductors.
- The circuit breakers can be easily connected from the front. It is simple to interchange a device or to add a device in a reserve slot.
- There are markings (N, L1, L2, L3) on the front and the sides for the phases.
- The running of auxiliary cables between the devices and the corresponding terminal blocks is also taken into account. Spacious trunking is built into the blocks for the auxiliary wiring.

PB502607-48_reps



PB502603-48_reps

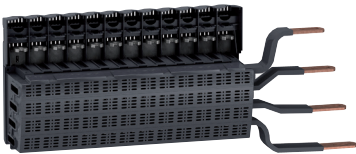

	Compact NSX100/250 & INS-INV250 - Toggle, fixed		Compact NSX100/250 - Rotary handle, motor mechanism, fixed, Compact NSX100/250 - All controls, withdrawable		Compact NSX100/250 & INS-INV250 - All controls, fixed and withdrawable	
	Lineryg FC with pre-fabricated connections by insulated flexible bars (1)		Lineryg FC with pre-fabricated connections (1)		Lineryg FC without pre-fabricated connections (1)	
Number of poles	3P	4P	3P	4P	3P	4P
Connection to	Lineryg LGY busbars		Lineryg BS, Lineryg LGY or Lineryg LGYE busbars		Lineryg BS, Lineryg LGY or Lineryg LGYE busbars	
Number of devices	4	3	4	3	4	3
Composition	Self-adhesive labels to mark the phases for connections to the busbars.					
Mounting plates						
Toggle, Fixed, NSX100/250	03420	03420	03420	03420	03420	03420
Toggle, Plug-in, NSX100/250	03421	03421	03421	03421	03421	03421
Rotary handle, motor mechanism, Fixed, NSX100/250	03422	03422	03422	03422	03422	03422
Cat. no.	04403	04404	04405	04406	04407 (2)	04408 (2)

Implementation

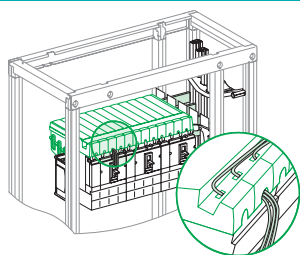

Auxiliary wires running in the built-in trunking.

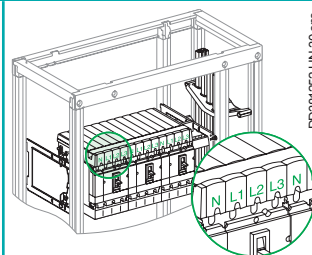

Phase marking on the front of the distribution block.

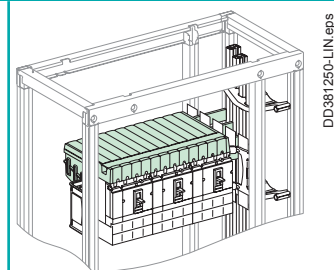

(1) The connection of a Lineryg FC distribution block using pre-wired connectors or insulated flexible bars is not compatible with Form 2 partitioning (04922). In this case, use the form 2 restoration kit (04924).

(2) For the connection, use insulated flexible bars, 32 x 8mm cat. no. 04753; Each connection must not be longer than 500 mm. This size is validated with Schneider Electric insulated flexible bars.

Accessories

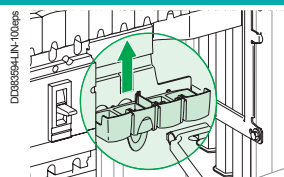

Tooth caps

The caps block off the reserve terminals on a Lineryg FC distribution block. Made of an insulating material, they simply clip on from the front.

Catalogue numbers

04809

Characteristics

Common characteristics

Rated operational current at 40°	(Ie)	Distribution-block derating follows the normal derating curves of Compact NSX and INS-INV
Rated conditional short-circuit current of an assembly	(Isc)	The reinforced breaking capacity due to cascading in circuit breaker combinations is maintained. The worst-case situations have been tested. The electrical characteristics are perfectly compatible with the connected devices. Neither the temperature derating curves nor the performance levels of the circuit breakers and switch-disconnectors are altered.
Rated insulation voltage	(Ui)	750 V AC
Rated operational voltage	(Ue)	690 V AC
Rated impulse withstand voltage	(Uimp)	8 kV
Rated peak withstand current	(Ipk)	50 kA rms
Rated short-time current with upstream protection of 85 kA Icc	(Icc)	85 kA
Thermal stress	(I².t)	2.500 x 10 ⁷
Rated conditional short-circuit current of an assembly		Short-circuit withstand current compatible with the breaking capacity of the Compact NSX circuit breakers connected to the distribution block.

Lineryg FC selection table for special cases

For most installations, the temperature around the switchboard is 40 °C, corresponding to an average temperature of 60 °C inside the switchboard.

Under certain conditions, the temperature inside the switchboard may be different.

(A) Rated operational current as a function of the temperature inside the switchboard

Temperature (°C)		40	45	50	55	60	65	70
I _{nc} (A)	3P	800	800	775	750	725	700	675
	4P	675	675	655	635	615	595	570

To obtain the maximum permissible current for the lineryg FC, apply the diversity factor K:

- Lineryg FC 3P: K = 0.8
- Lineryg FC 4P: RDF = 0.9.

IEC 61439-1 and 2

Description

Lineryg FC is an insulated horizontal distribution block. It connects directly to the mounting plate and can supply:

- Four 4P and five 3P Compact NSXm circuit breakers (four 3P and 4P for Compact NSXm Vigi), whatever the ratings (63, 100 or 160 A) with toggle and direct rotary handle operating mechanism.
- The design and small size blend thoroughly with the devices.
- It can be supplied by Lineryg BS, Lineryg LGYE and Lineryg LGY busbars positioned to the left or right.
- Fully insulated, Lineryg FC helps to protect life and property. Numerous and well distributed vents ensure natural convection and optimum cooling of the conductors.
- The circuit breakers can be easily connected from the front. It is simple to interchange a device or to add a device in a reserve slot.
- There are markings (N, L1, L2, L3) on the front and the sides for the phases.
- The running of auxiliary cables between the devices and the corresponding terminal blocks is also considered. Spacious trunking is built into the blocks for the auxiliary wiring.



DD435610.eps

DD435609.eps

	Compact NSXm - Toggle (with Everlink terminal)		Compact NSXm - Toggle/ DRH (with Everlink terminal)			
	Lineryg FC with prefabricated connections by insulated flexible bars (1)		Lineryg FC with prefabricated connections (1)		Lineryg FC without prefabricated connections (1)	
Number of poles	3P	4P	3P	4P	3P	4P
Connection to	Lineryg LGY busbars		Lineryg BS and Lineryg LGYE busbars			
Number of devices	5 (2)	4	5 (2)	4	5 (2)	4
Mounting plates	03416	03416	03416	03416	03416	03416
Cat. no.	04410	04411	04412	04413	04419	04420
	04416 (3)		04417 (3)		04418 (3)	

Implementation

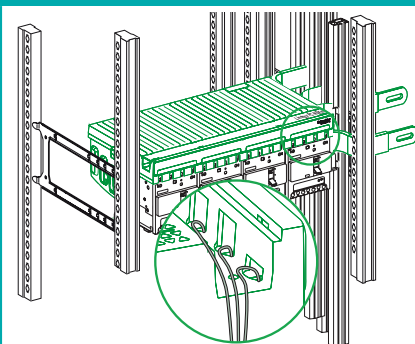

DD435612.eps

Auxiliary wires running in the built-in trunking.

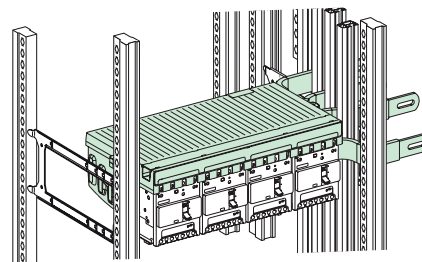

DD435613.eps

- (1) The connection of a Lineryg FC distribution block using pre-wired connectors or insulated flexible bars is not compatible with Form 2 partitioning (04922). In this case, use the form 2 restoration kit (04924).
- (2) Lineryg FC configuration having NSXm with Vigi can mount four devices in a row for both 3P and 4P.
- (3) The catalogue reference number is used only with NSXm Vigi.

Accessories

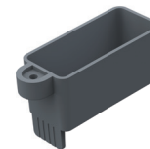
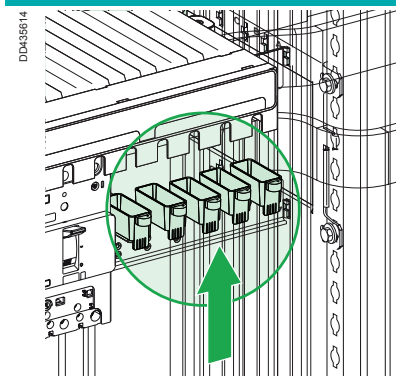

Tooth caps

The caps block off the reserve terminals on a Linergy FC distribution block. Made of an insulating material, they simply clip on and install the screw from the front.

Catalogue numbers

04810

Characteristics

Common characteristics

Rated operational current at 40°	(Ie)	Distribution-block derating follows the normal derating curves of Compact NSXm
Rated conditional short-circuit current of an assembly	(Isc)	The reinforced breaking capacity due to cascading in circuit breaker combinations is maintained. The worst-case situations have been tested. The electrical characteristics are perfectly compatible with the connected devices. Neither the temperature derating curves nor the performance levels of the circuit breakers and switch-disconnectors are altered.
Rated insulation voltage	(Ui)	800 V AC
Rated operational voltage	(Ue)	690 V AC
Rated impulse withstand voltage	(Uimp)	8 kV
Rated peak withstand current	(Ipk)	18 kA
Rated short-time current with upstream protection of 85 kA Icc	(Icc)	50 kA
Thermal stress	(I ² .t)	4.5 x 10 ⁶ A ² S
Rated conditional short-circuit current of an assembly		Short-circuit withstand current compatible with the breaking capacity of the Compact NSXm circuit breakers connected to the distribution block.

Linergy FC selection table for special cases

For most installations, the temperature around the switchboard is 40 °C, corresponding to an average temperature of 60 °C inside the switchboard.

Under certain conditions, the temperature inside the switchboard may be different.

(A) Rated operational current as a function of the temperature inside the switchboard

Ambient Air Temperature outside panel (°C)		35	40	45	50
IP31(A)	3P	600	575	550	525
	4P	500	480	460	440
IP55 (A)	3P	515	500	475	450
	4P	460	440	420	400

PB502399

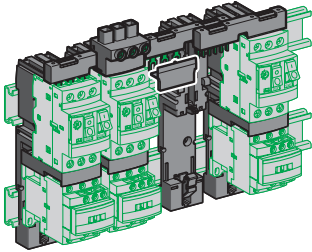

Description

It is much easier to create protection and control blocks, thanks to a range of accessories. These can be used to:

- Supply power to a group of blocks (combs and connection blocks GV2 G ●)
- Fix a fuse-carrier and a contactor on top of one another (mounting plate LAD 311)
- Interconnect a fuse-carrier and its contactor (rigid wiring modules GV2 AF ●, LAD 3 ●)
- Using them creates considerably more space in the switchboard and reduces the wiring time

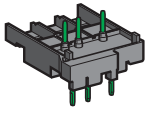
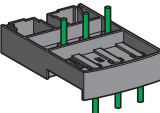
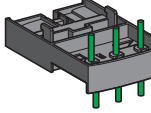
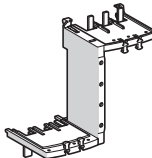
	Combination blocks			S-shape busbars	115 A busbars for connecting contactors in parallel	
						
	Between GV2 and contactor LC1 K or LP1 K	Between GV2 and contactor LC1 D09... D38	Between GV2 mounted on LAD 311 and contactor LC1 D09... D38	For circuit-breakers GV3 P ●● and GV3 L ●● and contactors LC1 D40A...D65A	Contactors LC1 D40A...D65A	
Set of	10	10	10		2	3
References	GV2 AF01	GV2 AF3	GV2 AF4	GV3 S	GV3 G264	GV3 G364

Accessories

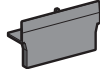
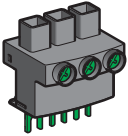
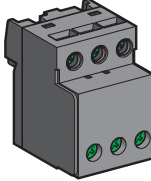
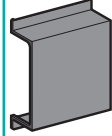
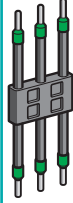
					
	Protective end cover	Terminal block for supply to one or more GV2 G busbar sets	Can be fitted with current limiter GV1 L3 (GV2 ME and GV2 P)	Cover for terminal block	Flexible 3-pole connecting a GV2 to a contactor LC1-D09... D25
	For unused busbar outlets	Connection from the top	Can be fitted with current limiter GV1 L3 (GV2 ME and GV2 P)	For mounting in modular panels	Centre distance between mounting rails: 100... 120 mm
Set of	5	1	1	10	10
References	GV1 G10	GV1 G09	GV1 G05	LA9 E07	GV1 G02

Accessories for main pole and control connections

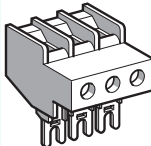
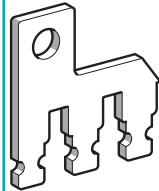
Number of poles	4-pole 10 mm ²	3-pole 25 mm ²	2-pole					
								
For use with contactors LC1	(~) (- - -)	DT20, DT25	D09...D38	D09...D38	DT20, DT25 (4P)	DT32, DT40 (4P)	D40A...D65A	D80, D95
Set of	1	1	10	10	10	1	2	
References	LAD 92560	LA9 D3260	LA9 D2561	LA9 D1261	LAD 96061	LAD 9P32	LA9 D80961	

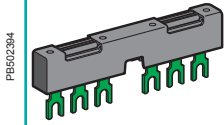
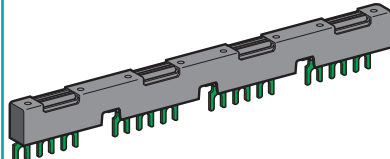
Sets of 3-pole 63 A busbars										
										
2 tap-offs			3 tap-offs				4 tap-offs			5 tap-offs
Pitch mm										
45	54	72	45	54	45	54	72	54		
GV2 G245	GV2 G254	GV2 G272	GV2 G345	GV2 G354	GV2 G445	GV2 G454	GV2 G472	GV2 G554		

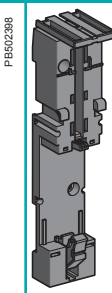
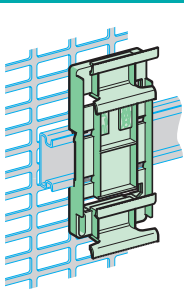
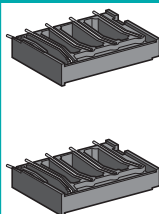
								
Adapter plates		Height compensation plate			Motor starter adapter plate		Connections upstream/downstream	
For mounting a GV2 ME or GV2 P and contactor LC1 D09... D38 with front faces aligned		7.5 mm			With 3-pole connection for mounting a GV2 and a contactor LC1 D09... D25		For connecting GV2 ME to a printed circuit board	
1		10			1		10	
LAD 311		GV1 F03			GK2 AF01		GV2 GA01	

3-pole					4-pole				
D09...D38	D40A...D65A	D80, D95	DT20, DT25	D80, D95	D09...D38	D40A...D65A	D80, D95	DT20, DT25	D80
10	1	1	2	2	LAD 9P3	LAD 9P33	LA9 D80962	LA9 D1263	LA9 D80963

For 3-pole reversing contactors

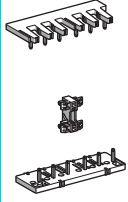
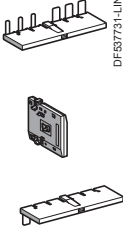
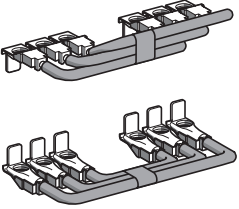
										
	LAD 9R1		LAD 9R3		LA9 D8069					
	Kits for assembly of reversing contactors									
Composition	<ul style="list-style-type: none"> ■ A mechanical interlock LAD 9V2 with electrical interlock LAD 9V1 ■ A set of power connections LAD 9V5 (parallel) and LAD 9V6 (reversing) 		<ul style="list-style-type: none"> ■ A mechanical interlock LAD 9V2 without electrical interlock ■ A set of power connections LAD 9V5 (parallel) and LAD 9V6 (reversing) 		<ul style="list-style-type: none"> ■ A mechanical interlock LAD 4CM ■ A set of power connections LA9 D65A69 				<ul style="list-style-type: none"> ■ A set of parallel bars ■ A set of reverser bars 	
For contactors	LC1 D09 to D38		LC1 D40A to D65A		LC1 D09 to D38 with screw terminals or connectors	LC1 D09...D32 with spring terminal connections	LC1 D40A to D65A	LC1 D80 and D95 (~)	LC1 D80 and D95 (—)	LC1 D115 and D150
References	LAD 9R1V	LAD 9R1	LAD 9R3	LAD 9R3	LAD 9V5 + LAD 9V6	LAD 9V12 + LAD 9V13	LA9 D65A69	LA9 D8069	LA9 D8069	LA9 D11569

For 4-pole changeover contactor

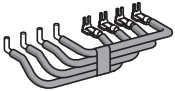
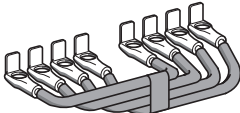
										
			LA9 D6570				LA9 D8070			
	Kits for assembly of changeover contactor pairs									
Composition	<ul style="list-style-type: none"> ■ A mechanical interlock LAD 9V2 with electrical interlock LAD 9V1 ■ A set of power connections (changeover) LAD 9V7 		<ul style="list-style-type: none"> ■ A mechanical interlock LAD 9V2 without electrical interlock ■ A set of power connections (changeover) LAD 9V7 		Comprising a set of parallel bars					
For contactors	LC1 DT20 to DT40 with screw terminals or connectors		LC1 DT60A and DT80A	LC1 D80004	LP1 D80004	LC1 D115004	LC1 DT203 to DT403 with spring terminals	LC1 D80004	LP1 D80004	
References	LAD T9R1V	LAD T9R1	LA9 D65A70	LA9 D8070	LA9 D8070	LA9 D11570	LAD 9V9	LA9 D8070	LA9 D8070	

For star-delta starter

- 1 time delay contact block LAD S2 (LC1 D09...D80)
- Power circuit connections (LC1 D09...D80)
- Hardware required for fixing the contactors onto the mounting plate (LC1 D80)

LC1 D09 and D12	LC1 D18 to D32	LC1 D40A and D50A	LC1 D80	Equipment mounting plates			
LAD 91217	LAD 93217	LAD 9SD3	LA9 D8017	LC1 D09, D12 and D18 LA9 D12974	LC1 D32 LA9 D32974	LC1 D40A and D50A -	LC1 D80 LA9 D80973

For 3-pole changeover contactor pairs

Mechanical interlocks		Sets of power connections
Without integral electrical interlock	With integral electrical interlock	Comprising a set of parallel bars
LC1 D40A...D65A	LC1 D115 and D150	LC1 D115 and D150
LAD 9R3S	LA9 D11502	LA9 D11571

Components for assembling 3-pole reversing contactors and changeover contactor pairs

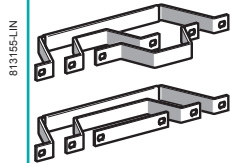

3-pole reversing contactors for motor control

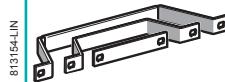

3-pole changeover contactor pairs

Horizontal mounting	LC1 F115	LC1 F150	LC1 F185	LC1 F225	LC1 F265	LC1 F330	LC1 F400	LC1 F500	LC1 F630 or F800
For assembly of 3-pole reversing contactors for motor control References	LA9 FF976	LA9 F15076	LA9 FG976	LA9 F22576	LA9 FH976	LA9 FJ976	LA9 FJ976	LA9 FK976	LA9 FL976
For assembly of 3-pole changeover contactor pairs References	LA9 FF982	LA9 F15082	LA9 FG982	LA9 F22582	LA9 FH982	LA9 FJ982	LA9 FJ982	LA9 FK982	LA9 FL982

Components for assembling 3 and 4-pole changeover contactor pairs

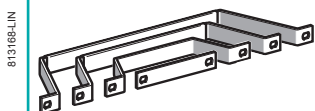

4-pole changeover contactor pairs

Horizontal mounting	LC1 F1154	LC1 F1504	LC1 F1854	LC1 F2254	LC1 F2654	LC1 F3304	LC1 F4004	LC1 F5004	LC1 F6304
Set of power connections References	LA9 FF977	LA9 F15077	LA9 FG977	LA9 F22577	LA9 FH977	LA9 FJ977	LA9 FJ977	LA9 FK977	LA9 FL977

Accessories

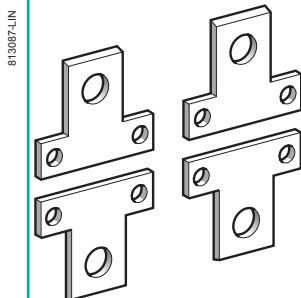

LA9 ● 602

Links for parallel connection of poles (in pairs)

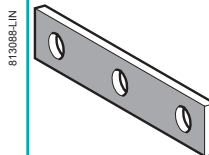

LA9 F ● 601

Links for "star" connection of 3 poles

	LC1 F1154	LC1 F1504, F1854	LC1 F2254, F2654, F3304, F4004	LC1 F5004	LC1 F6304	LC1 F115	LC1 F150, F185	LC1 F225, F265, F330, F400	LC1 F500	LC1 F630, F800
References	LA9 FF602	LA9 FG602	LA9 FH602	LA9 FK602	LA9 FL602	LA9 FF601	LA9 FG601	LA9 FH601	LA9 FK601	LA9 FL601

Right-angled connectors

813091-LIN

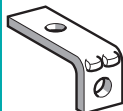

LA9 F ● 981

813093-LIN

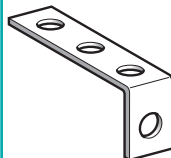

LA9 F ● 979

Contactors	LC1 F115			LC1 F150, F185			LC1 F225, F265, F330, F400		
Thermal overload relays	LR9 F5 ● 67, LR9 F67			LR9 F5 ● 69, F5 ● 71, LR9 F69, F71			LR9 F7 ● 75, LR9 F75		
Width (mm)	15			20			25		
Type	Rear	Side	Large surface area	Rear	Side	Large surface area	Rear	Side	Large surface area
References	LA9 FF981	LA9 FF979	LA9 FF980	LA9 FG981	LA9 FG979	LA9 FG980	LA9 FJ981	LA9 FJ979	LA9 FJ980

Right-angled connectors

DF510497-LIN

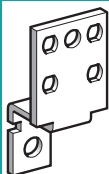



LA9 FL980

Contactors	LC1 F500			LC1 F630, F800		
Thermal overload relays	LR9 F7 ● 79, F7 ● 81, LR9 F79, F81			LR9 F7 ● 81, LR9 F81		
Width (mm)	30			40		
Type	Rear	Side	Large surface area	Rear	Side	Large surface area
References	LA9 FK981	LA9 FK979	LA9 FK980	LA9 FL981	LA9 FL979	LA9 FL980

Accessories

Contactors	LC1 F115	LC1 F150 and F 185	LC1 F185	LC1 F225 and F265		LC1 F330 and F400	LC1 F400	LC1 F500	LC1 F630, F800
Thermal overload relays	LR9 F5 ● 57, F5 ● 63, LR9 F5 ● 67, F5 ● 69, LR9 F69, F71	LR9 F5 ● 57, F5 ● 63	LR9 F5 ● 71, LR9 F71	LR9 F5 ● 71, LR9 F71	LR9 F7 ● 75, F ● 79, LR9 F75, F79	LR9 F7 ● 75, F7 ● 79, LR9 F75, F79	LR9 F7 ● 81, LR9 F81	LR9 F7 ● 75, F7 ● 79, LR9 F7 ● 81, LR9 F75, F79, F81	LR9 F7 ● 81, LR9 F81
Width (mm)	15	20	25	25	25	25	25	30	40
References	LA7 F401	LA7 F402	LA7 F407	LA7 F403	LA7 F404	LA7 F404	LA7 F404	LA7 F405	LA7 F406

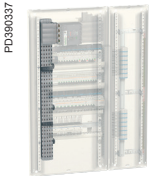

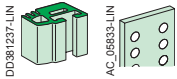
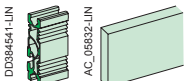
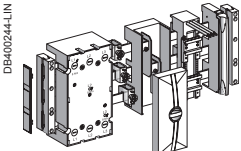
 <p>PD390659R</p>	Linery BS	46
	Rear flat busbars up to 400 A Multi-stage busbars up to 630 A Multi-stage distribution block up to 630 A Common accessories up to 630 A	46 47 48 49
 <p>PD390337</p>	Linery BW	50
	Insulated busbars up to 630 A	50
 <p>DD381237-LIN DD384500-LIN AC_05833-LIN</p>	Linery LGY, LGYE, BS	52
	Selection guide up to 4000 A	52
 <p>DD381237-LIN DD384500-LIN AC_05833-LIN</p>	Linery LGY, LGYE, BS	53
	Lateral	53
 <p>DD381237-LIN AC_05833-LIN</p>	Linery LGY, BS	56
	Rear	56
 <p>DD384541-LIN AC_05832-LIN</p>	Linery LGYE, BS	58
	Horizontal	58
 <p>DB400244-LIN</p>	Linery BZ	60
	Quick busbar systems	60

PD39652-SE

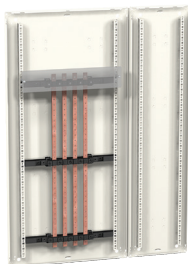

IEC 61439-1 & 2

Description

The busbar can be 3-pole or 4-pole with ratings between 160 A and 400 A. 2 lengths are available: 1000 and 1400 mm, which can be cut as required. The number of supports depends on the installation maximum rated current.

160 to 400 A copper busbars

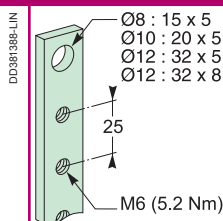

		160 A	250 A	400 A			
Rated peak withstand current	(I _{pk})	30 kÅ	40 kÅ	55 kÅ			
Rated insulation voltage	(U _i)	1000 V	1000 V	1000 V			
Rated short-time current	(I _{cw})	10 kA rms/1s	13 kA rms/1s	25 kA rms/1s			
Conductor cross-section		15 x 5 mm	20 x 5 mm	32 x 5 mm			
Installation		Threaded M6 holes every 25 mm all the way up Connection by: 16 to 50 mm ² flexible cables with crimped lugs					
Set of		4					
Length (mm)		1000	1400	1000	1400	1000	1400
References		04161	04171	04162	04172	04163	04173

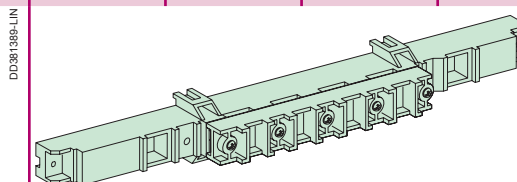

Insulating busbar support ⁽¹⁾

Distance between supports depending on I _{cw} /I _{pk} ⁽²⁾	≤ 10 kA rms/1 s/30 kÅ	≤ 13 kA rms/1 s/40 kÅ	≤ 15 kA rms/1 s/40 kÅ	≤ 20 kA rms/1 s/45 kÅ	≤ 25 kA rms/1 s/55 kÅ
	450 mm	450 mm	450 mm	450 mm	450 mm
	-	450 mm	450 mm	300 mm	225 mm
Installation	On the rear uprights Screwed onto a solid or pre-slotted plate (fixing centres 450 x 200 mm)				
References	04191	04191	04191	04191	04191

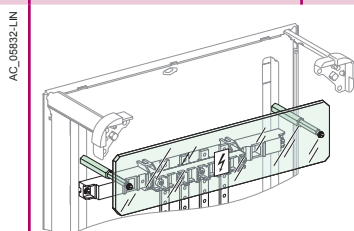

IPxxB insulating protective shield

Length	470 mm	470 mm	470 mm
Height	100 mm	100 mm	100 mm
Composition	Supplied with fixings		
References	04198	04198	04198

(1) The supports allow installation of a 5th busbar with 15 or 20 x 5 mm cross-section to create the earth collector.

(2) Linery FM 200 A distribution blocks with connections ref. 04029 can act as intermediate supports (max. distance apart 200 mm) in addition to the support ref. 04191 at the top and bottom.

PD306533_SE

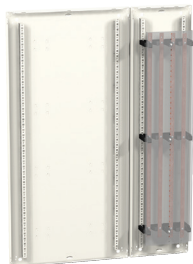

IEC 61439-1 & 2

Description

Multi-stage busbars are installed in a sheath L = 300 mm. We strongly recommend dividing the current between 2 cubicles or enclosures joined on either side. All the connection points are easily accessible from the front. The busbar orientation makes them easier to tighten and facilitates running the cables between them. The current can be 3-pole or 4-pole with ratings between 160 A and 630 A. 2 lengths are available: 1000 and 1400 mm, which can be cut as required. The number of supports depends on the installation maximum rated current.

160 to 630 A copper busbars

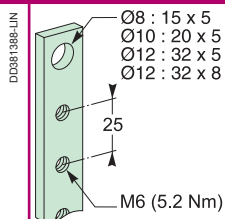

	160 A	250 A	400 A	630 A				
Rated peak withstand current (I _{pk})	30 kÅ	40 kÅ	55 kÅ	55 kÅ				
Rated insulation voltage (U _i)	750 V	750 V	750 V	750 V				
Rated short-time current (I _{cw})	10 kA rms/1s	13 kA rms/1s	15, 20 kA rms/1s	25 kA rms/1s				
Supply at incoming terminals	Connection by: 16 to 50 mm ² flexible cables with crimped lugs							
Conductor cross-section	15 x 5 mm	20 x 5 mm	32 x 5 mm	32 x 8 mm				
Installation	Flat copper busbar with threaded M6 holes every 25 mm all the way up							
Set of	4							
Length (mm)	1000	1400	1000	1400	1000	1400	1000	1400
References	04161	04171	04162	04172	04163	04173	Pending	04174

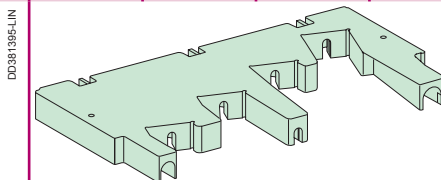

Insulating busbar support ⁽¹⁾

Support fixing centres in accordance with I _{cw} /I _{pk} ⁽²⁾	≤ 10 kA rms/1 s/30 kÅ	≤ 13 kA rms/1 s/40 kÅ	≤ 15 kA rms/1 s/40 kÅ	≤ 20 kA rms/1 s/45 kÅ	≤ 25 kA rms/0.6 s/55 kÅ	≤ 25 kA rms/1 s/55 kÅ
450 mm	-	450 mm	450 mm	450 mm	300 mm	300 mm
450 mm	-	450 mm	450 mm	450 mm	300 mm	300 mm
450 mm	-	450 mm	450 mm	450 mm	300 mm	300 mm
300 mm	-	-	-	300 mm	-	-
300 mm	-	-	-	300 mm	-	-
300 mm	-	-	-	-	-	300 mm
Installation	Installation on functional uprights in Prisma. Screwed onto a solid or pre-slotted plate (450 x 200 mm fixing centres)					
References	04192	04192	04192	04192	04192	04192

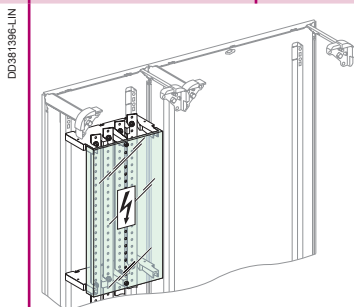

IPxxB insulating protective shield

Length	250 mm	250 mm	250 mm	250 mm
Height	1500 mm	1500 mm	1500 mm	1500 mm
Composition	Fixing accessories supplied with support ref. 04192			
References	04197	04197	04197	04197

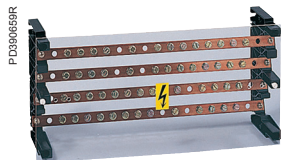

IEC 61439-1 & 2

Description

The distribution block can be installed horizontally in the device zone or vertically in the 300 mm wide duct of enclosures and cubicles.

The distribution block is made up of:

- two staggered supports made of an insulating material
- four slanted copper bars with holes every 25 mm

Multi-stage distribution blocks

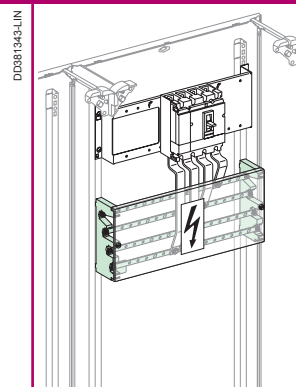
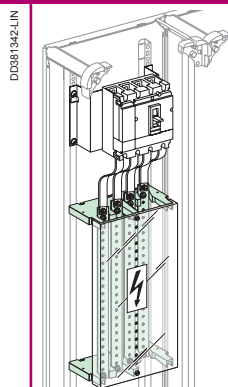

	160 A	250 A	400 A	630 A
Rated peak withstand current (I _{pk})	30 kA	30 kA	40 kA	40 kA
Rated insulation voltage (U _i)	750 V AC			
Rated operational voltage (U _e)	440 V			
Rated impulse withstand voltage (U _{imp})	8 kV			
Rated short-time current (I _{cw})	10 kA rms/1 s	13 kA rms/1 s	20 kA rms/1 s	25 kA rms/1 s
Total connection capacity	4 incomers per phase: ø 12.2 mm clearance holes 13 outgoing per phase 16 to 50 mm ² : M6 tapped holes			
Busbar cross-section	15 x 5 mm	20 x 5 mm	32 x 5 mm	32 x 8 mm
Dimensions (mm)				
Installation	Screwed in horizontal position on functional uprights in enclosures and cubicles (Prisma G) Screwed in vertical position on sheathed uprights (Prisma G) Screwed onto a solid or pre-slotted plate (fixing centres 450 x 200 mm) Screwed onto adapter ref. 03595 (Prisma P)			
Composition	2 multi-stage supports made of an insulating material 4 slanted copper busbars, with holes every 25 mm 1 pack of 36 M6 x 16 screws + contact washers 1 IPxxB front insulating shield			
References	04052	04053	04054	04055

Incomer accessories

EE6852

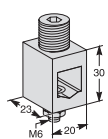

EE6851

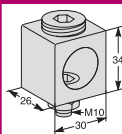

EE6850

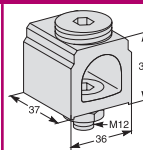

Connectors for copper or aluminium cables

Rated operational current at 40° (I _e)	160 A	250 A	400 A
Supply at incoming terminals	70 mm ² cables	16 to 185 mm ² cables	70 to 300 mm ² cables
Composition	Supplied with fixings at busbar end		
Set of	4		
References	07051	07052	07053

Outgoer accessories

DD081388-LIN

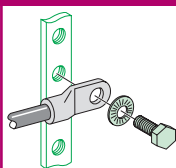

Class 8.8 fixings

Composition	20 M6 x 20 screws + 20 nuts + 40 contact washers	40 M6 x 16 screws + 40 contact washers
References	04194	04195

PD590337

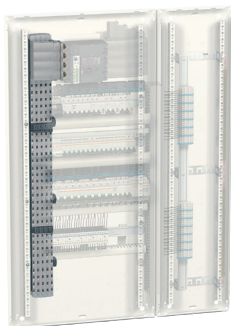

Description

- Compact busbar, **IPxxB**, ready for installation (supplied complete with supports and end caps)
- Shaped busbar, threaded M6 with 25-mm pitch, can be cut with 200-mm pitch (150 mm for the 125 A)
- Busbar installed on insulating supports, screwed onto the rear uprights
- Wide selection of tested pre-wired connectors
- Clip-on covers to protect against direct contact (IPxxB). Can easily be cut to allow connections to pass through to the switchgear
- Ends protected by end caps

Linery BW busbar

		125 A		160 A		250 A		400 A		630 A	
Rated peak withstand current	(Ipk)	20 kA		30 kA		30 kA		52.5 kA		52.5 kA	
Rated insulation voltage	(Ui)	500 V		750 V		750 V		750 V		1000 V	
Rated impulse withstand voltage	(Uimp)	8 kV		8 kV		8 kV		8 kV		8 kV	
Rated short-time current	(Icw)	8.5 kA rms/1 s		10 kA rms/1 s		13 kA rms/1 s		20 kA rms/1 s		25 kA rms/1 s	
Length (mm)		450	750	1000	1400	1000	1400	1000	1400	1000	1400
References	3P	04103	04107	04111	04116	04112	04117	04113	04118	04114	04119
	4P	04104	04108	04121	04126	04122	04127	04123	04128	04124	04129

Accessories

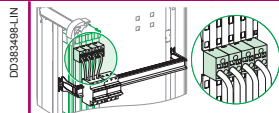
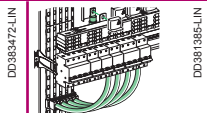
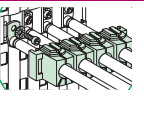
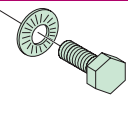
				
	IPxxB tap-off terminals	200 A connections	IPxxB insulating covers	Class 8.8 fixing accessories
	For one 6 mm ² cable and one 10 mm ² cable (Ui): 750 V	For one 1 to 16 mm ² cable (Ui): 750 V	Covers which can be clipped on and cut to size are used to isolate the connectors of a connection with cables of cross-section 10 to 25 mm ²	M6 x 12 + 20 M6 contact washers
Used for connecting	<ul style="list-style-type: none"> ■ All switchgear equipped with enclosed terminals ■ Linery FM 160/200 A 	<ul style="list-style-type: none"> ■ All switchgear equipped with enclosed terminals ■ Linery FM 63/80/160/200 A 	<ul style="list-style-type: none"> ■ Linery FM 200 A 	
Set of	12	12	4	8
References	04151	04152	04021	04150
				04158

Spare parts

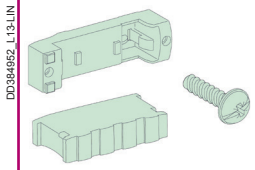
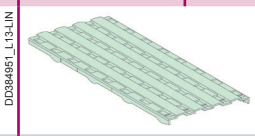
						
	Linery BW busbar supports					
Rated operational current at 40°	(Ie)	125 A	160 A	250 A	400 A	630 A
Composition		2 busbar supports + 2 end caps + packet of fixing accessories				
References		-	01210	01210	01210	01211
						
	IPxxB clip-on covers					
Length (mm)		200				
Set of		2				
References		-	01201	01201	01201	01201

Linery BW busbar connections with power supply unit

	Power supply units with connections			Universal power supply units + pre-wired connectors			Universal power supply units + connections to be made (flexible insulated busbars can be used)	
Used for connecting Compact	<ul style="list-style-type: none"> Horizontal NSX100/250 with or without Vigi Horizontal INS-INV250 	<ul style="list-style-type: none"> Horizontal NSX400 Horizontal INS-INV320/400 	<ul style="list-style-type: none"> Horizontal NSX630 Horizontal INS-INV500/630 	<ul style="list-style-type: none"> Enclosed NSX100/250 with toggle switch Enclosed vertical INS-INV250 	<ul style="list-style-type: none"> Sheathed NSX100/250 with or without Vigi Sheathed vertical INS-INV250 	<ul style="list-style-type: none"> Sheathed NSX400/630 with or without Vigi Sheathed INS-INV320/630 	<ul style="list-style-type: none"> Enclosed horizontal NSX100/250 with rotary handle or remote control Vertical Fupact INF100/160, Fupact ISFT100/250 	<ul style="list-style-type: none"> Enclosed NSX400/630 with or without Vigi Enclosed INS-INV320/630
References	04060	04070	04071	04061 + 04062	04061 + 04064	04074 + 04073	04061	04074

Pre-wired connectors

	Connections		IPxxB 3/4P monobloc connection	IPxxB 3/4P monobloc connection	Connections
	35 mm ² ferrule + 45° angled connector	45 mm ² ferrule + 45° angled connector	Quick connection on the busbar equipped with a male ferrule for enclosed terminals. Neutral identified by the colour blue.		-
Rated operational (Ie) current at 40°	125 A	160 A	160 A	160 A	200 A
Length	230 mm	250 mm	440 mm	150 mm	-
Used for connecting	<ul style="list-style-type: none"> NG125, INS-INV with enclosed terminals ref. 28947 or 28948 	<ul style="list-style-type: none"> INS-INV160, NG125, NG160 	<ul style="list-style-type: none"> NG160 (left-hand position), Vigi NG160 (middle position) NG125, INS-INV160, C120, iC120 	<ul style="list-style-type: none"> NG160 (left-hand position), NG125, INS-INV160, C120, iC120 	<ul style="list-style-type: none"> Linery FM 200 A
Set of	4	4	1	1	4
References	04145	04146	04148	04147	04021

IEC 61439-1 & 2

Description

Prisma P and SFP/PH switchboards have a complete, coherent system for routing the electrical current:

- optimised busbars
- pre-wired connectors
- customised distribution blocks

Vertical busbar

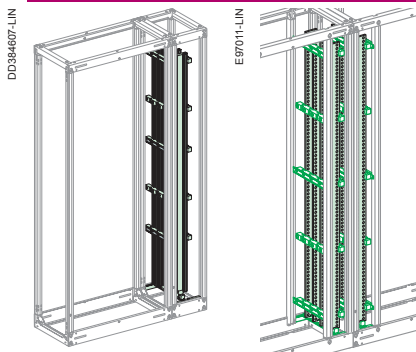

Lateral in sheath

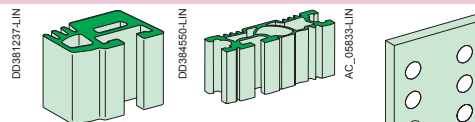

	LGY profile	LGYE profile	Linery BS flat busbars
Permissible current	Up to 3200 A	Up to 4000 A	Up to 3200 A
Material	Linery profile	Linery profile	Pre-slotted copper
Busbar	5 profile types depending on the current	9 profile types depending on the current	Th. 5 mm up to 1600 A Th. 10 mm up to 3200 A
Busbar length	1670 mm	2000 mm	1675 mm
Installation in Prisma P sheath	150 mm wide	Up to 1600 A	Up to 2500 A
	2 x 150 mm wide	Up to 3200 A	Up to 3200 A
	300 mm wide		For 3200-4000 A
Installation in SFP/PH sheath	300 mm wide	500 mm deep	Up to 4000 A
			500, 600 or 800 mm deep



At the back of a cubicle

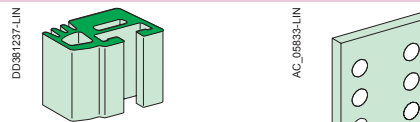

	LGY profile	Linery BS flat busbars
Permissible current	Up to 1600 A	Up to 1600 A
Material	Linery profile	Pre-slotted copper
Busbar type	5 profile types depending on the current	10 mm thick up to 1600 A
Busbar length	1670 mm	1675 mm
Installation	In 650 mm wide Prisma cubicle or 700 mm wide Prisma PH/SFP cubicle regardless of depth	

Horizontal busbar

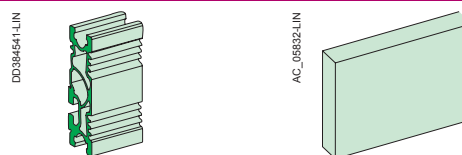
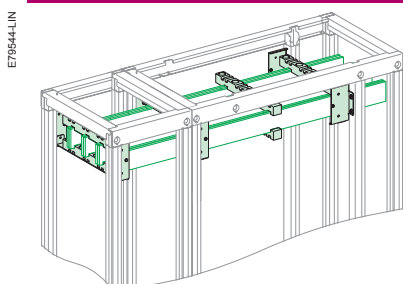

	LGYE profiles	Linery BS flat busbars
Permissible current	Up to 4000 A	Up to 4000 A
Material	Linery profile	Copper solid busbars
Busbar type	9 profile types depending on the current	5 mm up to 1600 A 10 mm up to 4000 A
Busbar length	2000 mm	2000 mm
Installation	At the top or bottom of the cubicle, horizontally 400 or 600 mm deep for Prisma P 500, 600 or 800 mm deep for SFP/PH	

Linery LGY profiles		Up to 1600 A (single busbar)					Up to 3200 A (double busbar)		
In Prisma P sheath		L150					2 x L150		
In SFP/PH sheath		L300					-		
Linery profile, 1670 mm long									
		630 A	800 A	1000 A	1250 A	1600 A	2 x 1000 A	2 x 1250 A	2 x 1600 A
Permissible current for an ambient temp. of 35°C around the switchboard	IP ≤ 31	680 A	840 A	1040 A	1290 A	1650 A	200 A	2500 A	3200 A
	IP > 31	590 A	760 A	950 A	1170 A	1480 A	1820 A	2260 A	2920 A
Number of profiles per phase		1					2		
References		04502	04503	04504	04505	04506	04504	04505	04506

Busbar supports

	Characteristics	An end stop must be fitted on the bottom support: 01109 (sold in lots of 12)								
	Number depending on Icw (kA rms/1 s)	≤ 25	3							2 x 3
	≤ 30	-	3							2 x 3
	≤ 40	-	-	3						2 x 3
	≤ 50	-	-	-	4					2 x 3
	≤ 60	-	-	-	-	5				2 x 4
	≤ 65	-	-	-	-	-	5			2 x 4
	≤ 75	-	-	-	-	-	-	7		2 x 5
	≤ 85	-	-	-	-	-	-	-	8	2 x 5
References		04651 (+ set of 2 upright adapters NSYSFPA for installation in SFP/PH cubicle)								

Equipotential bonding









	3 equipotential bonding items must be installed between the busbars	-		Connection made with a flat 80 x 10 mm busbar between 2 L150 sheaths
--	---	---	--	--

Connections to the Linery BS horizontal busbar

Characteristics		Fixings supplied. Order 1 connection per phase		
References according to horizontal busbar size	5 mm thick	04634 (1000 A)	04635 (1600 A)	-
	10 mm thick	Width ≤ 80 mm	04636	2 x 04636
	Width > 80 mm	04636 + 04642		2 x 04636 + 2 x 04642

Accessories

		Linery screw	Plain washer	Identification
Linery screw	Characteristics	Sold in lots of 20: 20 screws + 20 nuts + 20 contact washers, class 8.8. The screws slide into the profile and are then locked in the desired position.		
	References	25 mm long	04766 (for lug and flexible busbar connection)	
		39 mm long	04767 (for copper busbar connection)	
Steel plain washers	Characteristics	M8 sold in lots of 20		
	References	ext. ø 20 mm	04772	
		ext. ø 24 mm	04773	
		ext. ø 28 mm	04774	
Brass plain washers	Characteristics	M8 sold in lots of 20 for connection of ≤ 25 mm² lugs to Linery		
	References	ext. ø 20 mm	04775	
Identification	Characteristics	12 clip-on supports + N, L1, L2, L3, PE, PEN labels		
	References	04794		

Linery LGYE profiles									
	Up to 4000 A								
In Prisma P sheath	L150							L300	
In SFP/PH sheath	L300								
Linery profile, 2000 mm long									
	630 A	800 A	1000 A	1250 A	1600 A	2000 A	2500 A	3200 A	4000 A
Permissible current for an ambient temperature of 35°C around the switchboard	IP ≤ 31 530 A	680 A	850 A	1050 A	1480 A	1650 A	2100 A	2800 A	3620
	IP > 31 630 A	800 A	1000 A	1250 A	1650 A	2000 A	2440 A	3200 A	3350
Length to cut for side mounting	1675 mm							1625 mm	
Number of profiles per phase	1								
References	04560	04561	04562	04563	04564	04565	04566	04567	04568

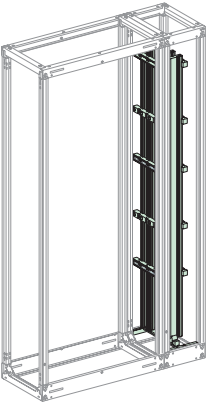
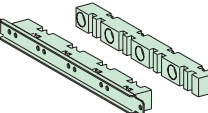
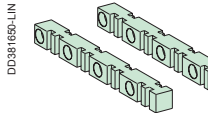
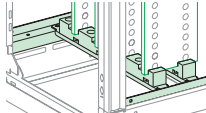

Busbar supports

			
	Fixed support 04661	Support arm 04662	04666
Characteristics	3 fixed supports are compulsory to hold the busbar in position. If more than 3 supports are needed, use support arms (in addition).		
Number depending on I _{cw} (kA rms/1 s)	≤ 30	3	
	≤ 40	5	3
	≤ 50	5	3
	≤ 60	5	3
	≤ 65		5
	≤ 75		7
	≤ 85		7
	≤ 100		9
References	04661 (fixed support) + 04662 (support arm if necessary)		04661 (fixed support) + 04671 (fixings) + 04662 (support arm if necessary)
			04661 (fixed support) + 04646 (sold in lots of 12 spacers) + 04662 (support arm if necessary)

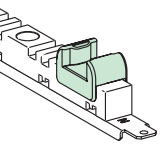
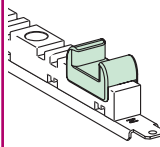
Wedging busbars in position

		
	Wedge fitted on bottom support	Wedge fitted on bottom support
Characteristics	The bottom support is used to place profiles and ensure they are in the correct position. It is not considered to be a busbar support.	
References	04663 (bottom support) 04658 (pack of 12 replacement shims)	04666 (bottom support) + 04661 (fixed support) 04659 (pack of 12 replacement shims)

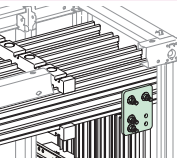
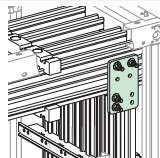
Connections to the Linery Evolution LGYE horizontal busbar

			
	≤ 1600 A	2000/2500 A	3200/4000 A
Characteristics	Supplied with fixings. References are supplied individually: 1 connection per phase.		
References according to horizontal busbar size	04604 (short connection) 04605 (long connection)	04607	

Flat busbars													
	Up to 1600 A						Up to 3200 A						
In Prisma P sheath	L150						L150			L300	2 x L150		
In SFP/PH sheath	L300 D500/600/800						L300 D500/600/800						-
Pre-slotted copper, 1675 mm long													
Permissible current for an ambient temp. of 35°C around the switchboard	IP ≤ 31	800 A	1000 A	1400 A	1800 A	1200 A	1400 A	1800 A	2050 A	2300 A	2820 A	3200 A	3200 A
	IP > 31	750 A	900 A	1250 A	1600 A	1080 A	1250 A	1600 A	1850 A	2000 A	2500 A	2820 A	2820 A
Busbar cross-section (mm)		60 x 5	80 x 5	60 x 5	80 x 5	50 x 10	60 x 10	80 x 10	50 x 10	60 x 10	80 x 10	100 x 10	80 x 10
Number of busbars per phase		1			2			1			2		
References		04516	04518	04516	04518	04525	04526	04528	04525	04526	04528	pending	04528

Busbar supports

Description	Attach directly to the sheath frame. 3 fixed supports are compulsory to hold the busbar in position. If more than 3 supports are needed, use support arms (in addition). The bottom wedge support is used to place the busbar and ensure it is in the correct position. It does not count as a busbar support.												
Number of supports depending on l _{cw} (kA rms/1 s)	≤ 15	3			3			3			2 x 3		
	≤ 25	5			3			3			2 x 3		
	≤ 30	5			5			3			2 x 3		
	≤ 40	7			5			5			2 x 3		
	≤ 50	7			5			5			2 x 3		
	≤ 60				7			5			2 x 5		
	≤ 65				7			5			2 x 5		
	≤ 75				9			7			2 x 5		
	≤ 85							7			2 x 5		
References of supports depending on distance between bars and sheath depth	Prisma P sheath 75 mm distance between bars	L150 mm	04661 (fixed) + 04662 (arm) + 04663 (shim)										
		L300 mm	04661 (fixed) + 04662 (arm) + 04666 + 04661 (shim) ⁽¹⁾										
	SFP sheath L300 75 mm distance between bars	D500 mm	NSYBV500 (fixed) + 04662 (arm) + NSYAS500 (shim) ⁽¹⁾										
		D600 mm	NSYBV600 (fixed) + 04662 (arm) + NSYAS600 (shim) ⁽¹⁾										
		D800 mm	NSYBV800 (fixed) + 04662 (arm) + NSYAS800 (shim) ⁽¹⁾										
	SFP sheath L300 115 mm distance between bars	D800 mm	NSYBV800L (fixed) + 04678 (arm) + NSYAS800L (shim) ⁽¹⁾										





(1) If using a 100 x 10 bars, add a pack of screws ref. 04671 for each fixed support 04661 and arm support 04662.

Connections to the Linery BS horizontal busbar

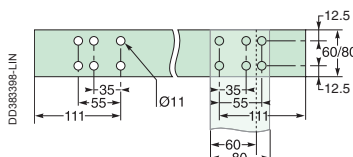
Characteristics													
	For a busbar with 75 mm distance between bars, the bars must be completely covered. Staggered assembly points between one bar and the next, to maintain the necessary clearance distances. ⁽²⁾	References 04636, 04637 are supplied individually: 1 connection per phase. Reference 04642 consists of 2 M8 x 140 screws which can replace the original M8 x 120 screws.											
Reference of the connection piece depending on horizontal busbar size	≤ 80 mm	Pending	1 bar per phase				2 bars per phase				double busbar		
	> 80 mm	Pending	50 x 10	60 x 10	80 x 10	50 x 10	60 x 10	80 x 10	100 x 10	80 x 10			
			04636	04637	04637	04637	04637	04637	04638	04636 x 2			
			04636 + 04642		04637 + 04642	04637 + 04642		04638		(04636 + 04642) x 2			

(2) Drill hole dimensions for 5 mm thick horizontal busbars

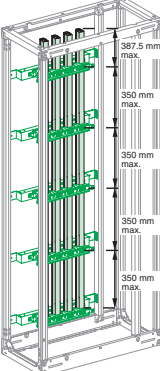
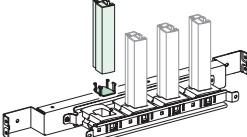

Linery LGY profiles		Up to 1600 A				
At the back of a Prisma P cubicle		L650				
At the back of a SFP/PH cubicle		L700				
Linery profile, 1670 mm long						
		630 A	800 A	1000 A	1250 A	1600 A
Permissible current for an ambient temp. of 35°C around the switchboard	IP ≤ 31	680 A	840 A	1040 A	1290 A	1650 A
	IP > 31	590 A	760 A	950 A	1170 A	1480 A
Number of profiles per phase		1				
References		04502	04503	04504	04505	04506

Busbar supports		References					
	Number depending on I _{cw} (kA rms/1 s) ≤ 25 ≤ 30 ≤ 40 ≤ 50	3	4		5		
		Characteristics 	An end stop must be fitted on the bottom support 01109 (sold in lots of 12)				
			04652				
			04652				
			04652				

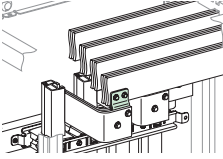
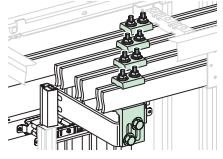
Connections to the Linery BS horizontal flat busbar		References	
		04635 connection to 5 mm thick horizontal busbar	04036 connection to 10 mm thick horizontal busbar
		Characteristics Fixings supplied, order 1 connection per phase. For part of the connection, flexible insulated busbars are needed.	
References according to horizontal busbar size	5 mm thick	04635	
	10 mm thick	Width ≤ 80 mm	04636
	thick	Width > 80 mm	04636 + 04642

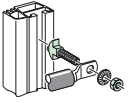
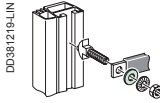
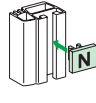
Accessories		References		
Linery screw	Characteristics Reference 25 mm wide 39 mm wide			
		Sold in lots of 20: 20 screws + 20 nuts + 20 contact washers, class 8.8 The screws slide into the profile and are then locked in the desired position		
		04766 (for lug and flexible busbar connection) 04767 (for copper busbar connection)		
Steel plain washers	Characteristics Reference ext. ø 20 mm ext. ø 24 mm ext. ø 28 mm	M8 sold in lots of 20		
		04772		
		04773		
Brass plain washers	Characteristics Reference ext. ø 20 mm	M8 sold in lots of 20 for connection of ≤ 25 mm ² lugs to Linery		
		04775		
Identification	Characteristics Reference	12 clip-on supports + N, L1, L2, L3, PE, PEN labels		
		04794		

Flat busbars							
	Up to 1600 A						
At the back of a Prisma P cubicle	L650						
At the back of a SFP/PH cubicle	L700			-	L700		
Pre-slotted copper, 1670 mm long							
Permissible current for an ambient temperature of 35°C around the switchboard	800 A	1000 A	1400 A	1800 A	1000 A	1200 A	1600 A
IP ≤ 31	800 A	1000 A	1400 A	1800 A	-	-	-
IP > 31	750 A	900 A	1250 A	1600 A	1080 A	1250 A	1600 A
Busbar cross-section (mm)	60 x 5						
Number of busbars per phase	1			2		1	
References	04516	04518	04516	04518	04525	04526	04528

Busbar supports							
	Fixed busbar support 04653		Busbar support arm 04662				
Characteristics	3 fixed supports ref. 04653 are compulsory to keep the busbar vertical. If more than 3 supports are needed, use support arms ref. 04662 (in addition). Metal shim ref. 04669 (sold in lots of 100), 5 mm thick, is screwed onto the busbar. It rests on a fixed support and is used to wedge the busbar in position.						
	Wedging: 1 busbar/phase		Wedging: 2 busbars/phase				
Number depending on I _{cw} (kA/arms/1 s)	≤ 15	3					3
	≤ 25	5			3		3
	≤ 30	5					5
	≤ 40	7		5			5
	≤ 50		7				5
	≤ 60						7
	≤ 65						7
	≤ 75						9
	≤ 85						
References	04653 (fixed) + 04662 (arm) + 04669 (shim)						

Connections to the Linergy BS horizontal flat busbar							
	04635 connection to horizontal busbar 5 mm thick		04636 connection to horizontal busbar 10 mm thick				
Characteristics	For part of the connection, flexible insulated busbars are needed. References 04635 , 04636 are supplied individually = 1 connection per phase. Reference 04642 consists of 2 M8 x 140 screws which can replace the original M8 x 120 screws.						
References according to horizontal busbar size	5 mm thick		04635				
	10 mm thick	Width ≤ 80 mm	04636				
		Width > 80 mm	04636 + 04642				

Linergy LGYE profiles										
Installation in Prisma P and SFP/PH	Up to 1600 A					Up to 4000 A				
Linergy profile, 2000 mm long, supplied with an end stop to wedge the profile in place										
	630 A	800 A	1000 A	1250 A	1600 A	2000 A	2500 A	3200 A	4000 A	
Permissible current for an ambient temperature of 35°C around the switchboard	IP ≤ 31	630 A	800 A	1000 A	1250 A	1650 A	2000 A	2440 A	3200 A	3620
	IP > 31	530 A	680 A	850 A	1050 A	1480 A	1650 A	2100 A	2800 A	3350
Number of profiles per phase	1									
Total number of vertical modules (50 mm)	3					3		4		
References	04560	04561	04562	04563	04564	04565	04566	04567	04568	

Busbar supports

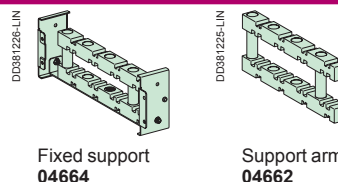
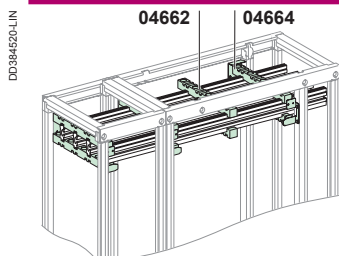

Characteristics		2 fixed supports for 650 to 800 wide frame and 1 fixed support for 300 or 400 wide frame (2 when the busbar is at the bottom) are compulsory. If more supports are needed, add support arms if necessary.	
Busbar supports 75 mm distance between	Number of supports	≤ 15	2
	≤ 25		2
	≤ 30		2
	≤ 30 depending on I _{cw} (kA rms/1 s)		2
	≤ 40		2
	≤ 50	2	2
	≤ 60	3	2
	≤ 65		3
	≤ 75		3
	≤ 85		3
≤ 100		-	4
References	Fixed support	04664	04664 + 04671 (fixings) 04664 + 04646 (sold in lots of 12 spacers)
References	Support arm	04662	04662 + 04671 (fixings) 04662 + 04646 (sold in lots of 12 spacers)

Joining

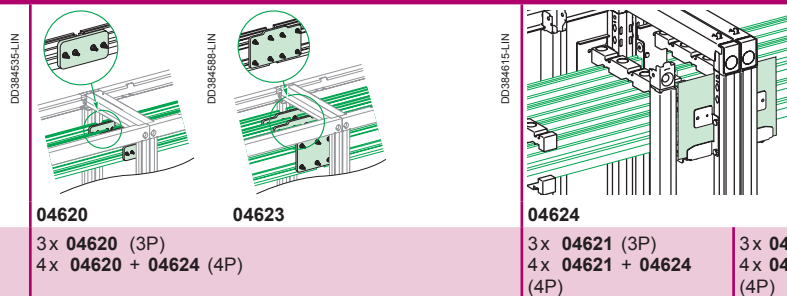

References	3x 04620 (3P) 4x 04620 + 04624 (4P)	04624	3x 04621 (3P) 4x 04621 + 04624 (4P)	3x 04623 (3P) 4x 04623 + 04624 (4P)
Note	Reference 04624 is compulsory when installing jointed Linergy LGYE 4P busbars and must be fitted where the frames meet. When installed at the bottom of a cubicle, the busbar must be partitioned.			

Flat busbars		Up to 1600 A				Up to 4000 A					
Installation in Prisma P and SFP/FH											
Solid copper, 2000 mm long											
Permissible current for an ambient temp. of 35°C around the switchboard	IP ≤ 31	800 A	1000 A	1400 A	1800 A	1800 A	2050 A	2300 A	2820 A	3300 A	3760 A
	IP > 31	750 A	900 A	1250 A	1600 A	1600 A	1850 A	2000 A	2500 A	2900 A	3340 A
Busbar cross-section (mm)		60 x 5	80 x 5	60 x 5	80 x 5	80 x 10	50 x 10	60 x 10	80 x 10	100 x 10	120 x 10
Number of busbars per phase		1	1	2	2	1	2	2	2	2	2
Total number of vertical modules (50 mm)		3									
References		04536	04538	04536	04538	04548	04545	04546	04548	04550	04552

Busbar supports

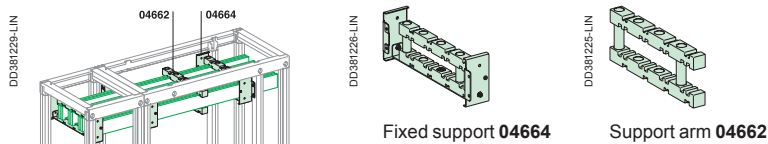

In cubicle: Prisma P L650 or L650+150 or SFP L700/PH D500/600/800 with 75 mm distance between bars	Number of supports	≤ 15	2		2						
	depending on lcw (kA rms/1 s)	≤ 25	3	2		2					
		≤ 30	3		2	2					
		≤ 40	3			2					
		≤ 50	-	3		3		2			
		≤ 60	-			3			2		
		≤ 65	-			3					
		≤ 75	-			4	3				
		≤ 85	-			-		3			
	References	Fixed support	04664		04664		04664 + 04671 (fixings)				
Support arm	04662		04662		04662 + 04671 (fixings)						
In sheath: Prisma P L400 with 75 mm distance between bars	Number of supports	≤ 25	1		1						
	depending on lcw (kA rms/1 s)	≤ 40	2		1						
		≤ 50	2		2						
		≤ 85	-		2						
		References	Fixed support	04664		04664		04664 + 04671 (fixings)			
Support arm	04662		04662		04662 + 04671 (fixings)						
In sheath: Prisma P L300 or SFP L300/PH with 75 mm distance between bars	Number depending on lcw (kA rms/1 s)	≤ 30	1		1						
	≤ 50	2		1							
	≤ 85	-		2							
	References	Fixed support	04664 (Prisma P) or NSYBHS500 (SFP D500) or NSYBHS600 (SFP D600) or NSYBHS800 (SFP D800)		04664 (Prisma P) or NSYBHS500 (SFP D500) or NSYBHS600 (SFP D600) or NSYBHS800 (SFP D800)		04664 (Prisma P) or NSYBHS500 (SFP D500) or NSYBHS600 (SFP D600) or NSYBHS800 (SFP D800) + 04671 (fixings)				
	Support arm	04662		04662		04662 + 04671 (fixings)					
In SFP cubicle L700 with 115 mm distance between bars	Number depending on lcw (kA rms/1 s)	≤ 30	-		2						
	≤ 40	-			3		2				
	≤ 60	-			3						
	≤ 75	-			4		3				
	≤ 85	-			-	4	3				
	References	Fixed support			NSYBHS800L		NSYBHS800L + 04671 (fixings)				
Support arm			04678		04678 + 04671 (fixings)						
In SFP L300 sheath with 115 mm distance between bars	Characteristics	2 fixed supports for 700 wide frame and 1 fixed support for 300/400 wide frame are compulsory. If more supports are needed, add support arms.									
	Number depending on lcw	≤ 50	-		1						
	≤ 85	-			2						
	References	Fixed support			NSYBHS800L		NSYBHS800L + 04671 (fixings)				
Support arm			04678		04678 + 04671 (fixings)						

Joining

Sliding joints with self-breaking lock nut

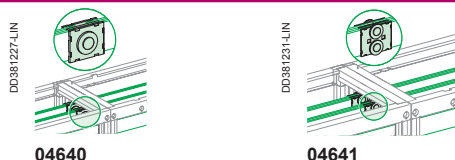

References (1 joint per phase)	04640	04641	04640	04641	04641	04640	04641		04643
--------------------------------	-------	-------	-------	-------	-------	-------	-------	--	-------

Note When installed at the bottom of a cubicle, the busbar must be partitioned.

IEC 60439-1 & UL845



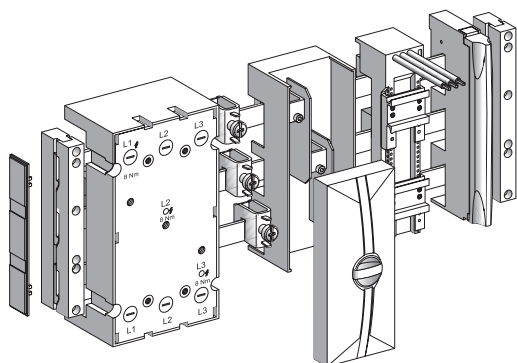

DB403874-LIN



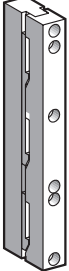

Description

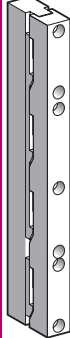
This mounting plate system for busbars simplifies the installation of motor feeder components used in your electrical installations. Power distribution is performed by a busbar. The mounting plates are fitted directly on this busbar, by snap-on mounting, thus implementing electrical distribution.

IEC busbar supports and accessories

Number of poles	3		4	
				
	LA9ZX01495	LA9ZX01573	LA9ZX01485	LA9ZX01131
	For 12, 15, 20, 25, 30 x 5/10 mm ² busbars	End covers for 3-pole busbar support	For 12, 15, 20, 25, 30 x 5/10 mm ² busbars	End covers for 4-pole busbar support (5 left, 5 right)
Set of	10	10	10	10
References	LA9ZX01495	LA9ZX01573	LA9ZX01485	LA9ZX01131

UL busbar supports and accessories

Number of poles	3	
		
	LA9ZX01508	LA9ZX01573
	For 12, 20, 30 x 5/10 mm busbars	Base plate 240 x 700
Set of	10	2
References	LA9ZX01508	LA9ZX01515
		End covers for busbar support
		10
		LA9ZX01573

Technical data

General characteristics								
LA9ZX01495 and LA9ZX01485 (IEC)								
Compatibility of bar dimensions	12 x 5 mm	15 x 5 mm	20 x 5 mm	25 x 5 mm	30 x 5 mm	12 x 10 mm	20 x 10 mm	30 x 10 mm
Rated operational current at 40° (Ie)	200 A	250	320	400	450	360	520	630
Rated peak withstand current (Ipk)	30 kA	30 kA	30 kA	30 kA	45 kA	35 kA	35 kA	53 kA
Distance max. between 2 busbars supports	570 mm	570 mm	570 mm	570 mm	570 mm	570 mm	570 mm	570 mm
Degree of protection	IP20 (with cover LA9ZX01244 or LA9ZX01245)							
Thermal resistance	125°C							
Rated current frequency	50/60 Hz							
Rated insulation voltage	690 V							
Rated operating voltage	690 V							

LA9ZX01508 (UL)								
Compatibility of bar dimensions	12 x 5 mm	20 x 5 mm	30 x 5 mm	12 x 10 mm	20 x 10 mm	30 x 10 mm		
Rated operational current at 40° (Ie)	150 A	362 A	500 A	300 A	564 A	630 A		
Irms surge current	18 kA	18 kA	22 - 25 kA	18 kA	18 kA	22 - 25 kA		
SCCR (protected by Compact NSX circuit breaker)	250 A 480 V AC	65 kA	-	-	65 kA	-	-	
	250 A 600 V AC	25 kA	-	-	25 kA	-	-	
	400 A 480 V AC	-	65 kA	65 kA	-	65 kA	65 kA	
	400 A 600 V AC	-	35 kA	35 kA	-	35 kA	35 kA	
	500 A 480 V AC	-	-	65 kA	-	-	65 kA	
	600 A 600 V AC	-	-	35 kA	-	-	-	
	600 A 480 V AC	-	-	50 kA	-	-	50 kA	
SCCR (protected by fuses Class J or T, etc.)	400 A 480 V AC	100 kA	100 kA	100 kA	100 kA	100 kA	100 kA	
	500 A 480 V AC	-	-	100 kA	-	-	100 kA	
	500 A 600 V AC	-	-	100 kA	-	-	100 kA	
Max. distance between 2 busbar supports (busbar protected)	400 mm	800 mm	800 mm	400 mm	800 mm	800 mm		
Degree of protection	IP20 (with cover LA9ZX01244 or LA9ZX01245)							
Thermal resistance	125°C							
Rated current frequency	50/60 Hz							
Rated operating voltage	600 V							

For TeSys GV2 motor circuit breakers

DB403877

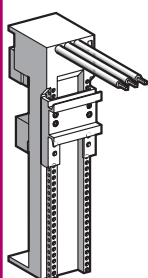

LA9ZA32443, LA9ZA32621

DB403878

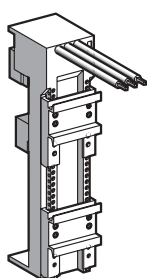

LA9ZA32434, LA9ZA32442

DB403846

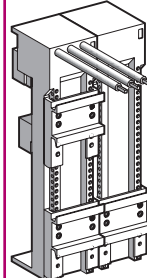

LA9ZA32622, LA9ZA32623

	Mounting plate, 1-way		Mounting plate, 2-way	
Operating current AC-3 440 V	25 A	32 A	25 A	32 A
Protection by motor circuit breaker	GV2 ME GV2 P GV2 LE	GV2 ME GV2 P GV2 LE	GV2 ME GV2 P GV2 LE	GV2 ME GV2 P GV2 LE
For contactor	LC1 D LC1 K LP4 K06-K12	LC1 D	LC1 D LC1 K LP4 K06-K12	LC1 D
Dimensions (L x H x W) (mm)	45 x 200 x 63	45 x 200 x 63 54 x 200 x 63 63 x 200 x 63	90 x 200 x 63	90 x 200 x 63
Set of	4	4 4 4	2	2
References	LA9ZA32621	LA9ZA32434 LA9ZA32442 LA9ZA32443	LA9ZA32622	LA9ZA32623

TeSys U starter-controllers

DB403879

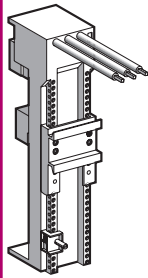

LA9ZA32427

DB403880

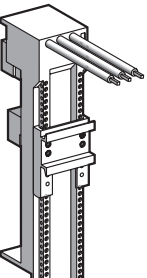

LA9ZA32428

	Mounting plate, 1-way	Mounting plate, 2-way
Operating current AC-3 440 V	32 A	32 A
Protection by power base	LUB12, LUB32	LUB12, LUB32
Dimensions (L x H x W) (mm)	45 x 200 x 63	45 x 200 x 63
Set of	4	4
References	LA9ZA32427	LA9ZA32428

Determining the spacing between busbar supports (LA9ZX01495 and LA9ZX01485), according to IEC 60439-1⁽¹⁾

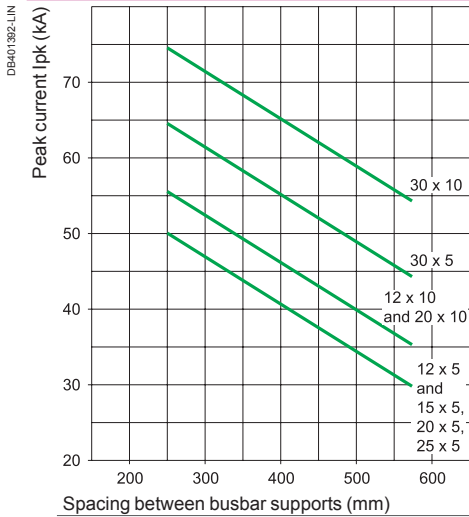

Short-circuit withstand diagram according to UL845 (LA9ZX01508)

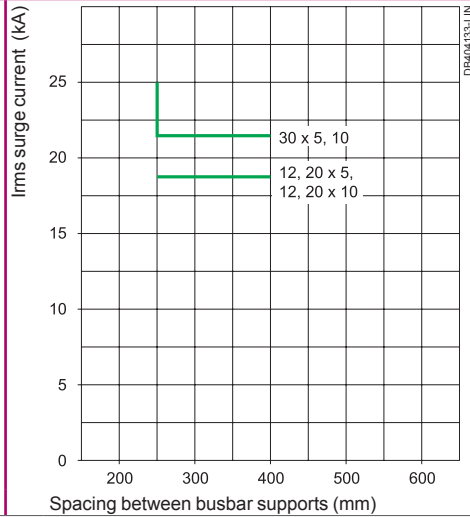

(1) Depending on the short-circuit current.

For TeSys GV3 motor circuit breakers

DB403881

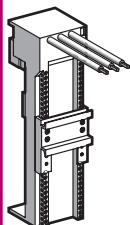

LA9ZA32624

DB403882

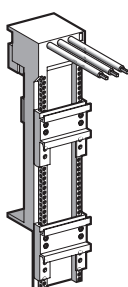

LA9ZA32625

DB403883

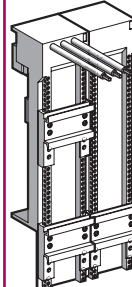

LA9ZA32626

	Mounting plate, 1-way		Mounting plate, 2-way
Operating current AC-3 440 V	63 A		25 A
Protection by power base	GV3 P	GV3 P	GV3 P
For contactor	-	LC1 D40A...65 A	LC1 D40A...65 A
Dimensions (L x H x W) (mm)	54 x 200 x 63		117 x 260 x 63
Set of	4		2
References	LA9ZA32624		LA9ZA32626

For TeSys integral contactor-circuit breakers | **For TeSys GV7 motor circuit breakers**

DB404138

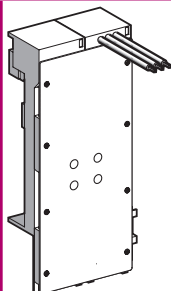

LA9ZA32627

	Mounting plate, 1-way	
Operating current AC-3 440 V	63 A	80 A
Protection by contactor-circuit breaker	LD1, LD4 LD<	GV7
Dimensions (L x H x W) (mm)	108 x 260 x 63	104 x 190 x 63
Set of	1	1
References	LA9ZA32627	LV429372

For Compact NSX circuit breakers

DB403877

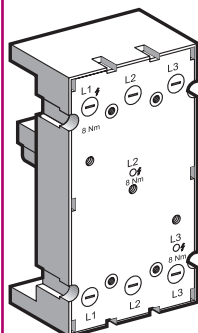

LV432623

DB403886

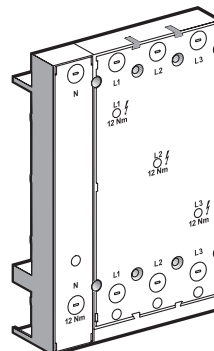

LV432624

	Mounting plate for 3P circuit breakers	Mounting plate for 4P circuit breakers	Mounting plate for 3P circuit breakers	Mounting plate for 4P circuit breakers
Rated operational current at 40° (Ie)	100-250 A		400-630 A	
Dimensions (L x H x W) (mm)	104 x 190 x 63	139 x 251 x 63	139 x 270 x 63	139 x 270 x 63
Set of	1	1	1	1
References	LV429372	LV429373	LV432623	LV432624

Technical data

Characteristics of busbar mounting plates					
Type of mounting plate	LA9ZA32621 LA9ZA32622	LA9ZA32427 LA9ZA32428 LA9ZA32434 LA9ZA32623 LA9ZA32442 LA9ZA32443	LA9ZA32624 LA9ZA32625 LA9ZA32626 LA9ZA32627	LV429372 LV429373	LV432623 LV432624
Degree of protection as per IEC 60529 (IP)	20				
Rated insulation voltage	690 V				
Permissible current	25 A	32 A	63 A	80 A - 100 A - 250 A	400 A-630 A
Peak rated current	50 kA	50 kA ⁽¹⁾	50 kA	50 kA	50 kA
SCCR (UL) with Compact NSX circuit breaker protection (mm ²)	The cascading reinforced breaking capacity when combining circuit breakers is maintained				
Conductor cross section (colour: black)	4 mm ² 12 AWG	6 mm ² 10 AWG	10 mm ² 8 AWG	-	-
Type of conductor insulating material (PVC)	105°				

(1) 35 kA with LUB12 for LA9ZA32427 and LA9ZA32428.
(1) 35 kA avec LUB12 pour LA9ZA32427 et LA9ZA32428.

For PowerPact 3P circuit breakers

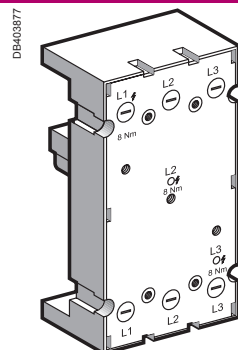

LA9ZA32600

	Mounting plate for H frame circuit breakers	Mounting plate for J frame circuit breakers	Mounting plate for L frame circuit breakers
Rated operational current at 40° (Ie)	60-100-150 A	250 A	250-400-600 A
Dimensions (L x H x W) (mm)	104 x 190 x 63	104 x 190 x 63	139 x 270 x 63
Set of	1	1	1
References	LA9ZA32600	LV429372	LV432623

Terminals

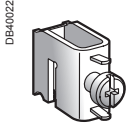
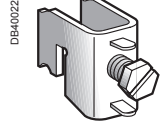
Number of poles	1P		
			
	LA9ZX01285	LA9ZX01287	
	For flat bars, 5 mm		3P cover, width 84 mm
Rated operational current at 40° (Ie)	270 A	400 A	
Supply at incoming terminals	4 - 35 mm ²	16 - 70 mm ²	
Set of	50	25	10
References	LA9ZX01285	LA9ZX01287	LA9ZX01413

Terminals on mounting plate

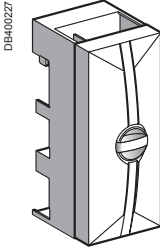
Number of poles	3P		
			
	LA9ZX01243		
	On mounting plate + cover, for 12 x 5 to 30 x 10 busbars		
Rated operational current at 40° (Ie)	440 A		
Supply at incoming terminals	35 - 120 mm ²		
Set of	1		
References	LA9ZX01243		

Connection module

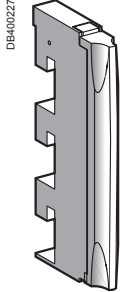
Number of poles	3P		
			
	LA9ZX01563		
	Spring terminal connection + cover, for busbars of 12 x 5 to 30 x 10		
Rated operational current at 40° (Ie)	80 A		
Supply at incoming terminals	1.5 - 16 mm ²		
Set of	8		
References	LA9ZX01563		

Technical data

Connection by connectors								
	LA9ZX01285		LA9ZX01287		LA9ZX01243		LA9ZX01563	
	Min.	Max.	Min.	Max.	Min.	Max.	Min.	Max.
Flexible wire	4 mm ²	35 mm ²	16 mm ²	70 mm ²	35 mm ²	120 mm ²	1.5 mm ²	16 mm ²
Multi-core wire	4 mm ²	35 mm ²	16 mm ²	70 mm ²	35 mm ²	120 mm ²	1.5 mm ²	16 mm ²
Rigid wire	4 mm ²	35 mm ²	-	-	-	-	1.5 mm ²	16 mm ²
Tightening torque	... x 5 N.m Supplied without cover		... x 5 N.m Supplied without cover		... x 5-10 N.m		... x 5-10 N.m	



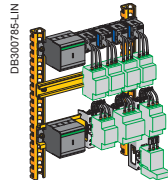

Linergy HK	70
Hot plug pre-assembled busbar systems	70

IEC 60439

Description

The assembly of automated control and distribution panels requires the use of products that are not only safe, but also simple and quick to mount and wire up. These pre-assembled busbar systems meet all these criteria.

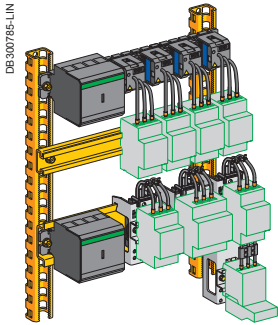

Busbar systems

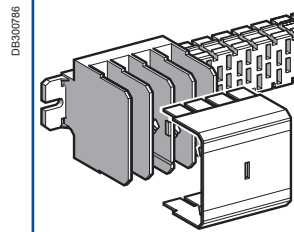

Number of conductors	4					
Number of tap-offs at 18 mm intervals	12	18	24	30	48	54
Length (mm)	344	452	560	668	992	1100
Suitable for mounting in enclosure width (mm)	600	800	800	800	1200	1200
References	AK5 JB143	AK5 JB144	AK5 JB145	AK5 JB146	AK5 JB149	AK5 JB1410

Technical data

Busbar system characteristics						
Product certifications	UL, CSA, DNV, LROS					
Degree of protection	Against access to live parts	IPxxB conforming to IEC 60529				
Flame resistance	Conforming to IEC 60695	850°C (incandescent wire)				
	Conforming to standard UL 94	V0				
Number of conductors	AK5 JB14p	4				
Supply current	a					
Rated operational current (Ie)	Ambient temperature 35°C	160 A				
	K coefficient to be applied according to the ambient temperature	35°C	40°C	45°C	50°C	55°C
Rated insulation voltage (Ui)	Conforming to IEC 60439-1	690 V				
	Conforming to UL and CSA	600 V				
Operational voltage (Ue)	Off-load plugging-in and unplugging, with power on					
	Conforming to IEC 60439-1	400 V				
	Conforming to UL, CSA	480 V				
	Plugging-in and unplugging, with power off					
	Conforming to IEC 60439-1	690 V				
	Conforming to UL, CSA	600 V				
Maximum permissible peak current	25 kA					
Maximum let-through energy (I ² t)	1 x 10 ⁷ A ² s					
Rated operational frequency	50 Hz or 60 Hz					
Upstream short-circuit ⁽¹⁾ and overload protection	Type of protection	Schneider Electric circuit-breaker			Fuses	
		NSX 160 N	NSX 160 H	aM	gF	
	Rating	160 A	160 A	160 A	160 A	
	Prospective short-circuit current	36 kA	70 kA	100 kA	100 kA	
	Operational current	160	160	160	160	
Supply incoming terminals	Maximum c.s.a.			Minimum c.s.a.		
	Flexible cable with cable end	70 mm ²			2.5	
	Solid cable	70 mm ²			2.5	
	Tightening torque	10 Nm				
Installation	Horizontal or vertical ⁽²⁾	Fixing with screws provided				

(1) For conditions where conditional short-circuit current exceeds 25 kA.

(2) Using side stop **AK5 BT01** on mounting plates **AK5 PA**.

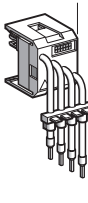
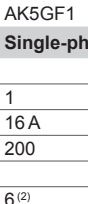
	Omega rail, width 75 mm	Removable power sockets			
	 AK5PC12	 AK5PC14			
		 AK5GF1			
Number of poles		Single-phase + Neutral		2-phase	
Material and surface treatment	2 mm sheet steel				
Number of points used on the busbar system		1		1	
Rated operational current at 40° (Ie)		16 A	32 A	16 A	32 A
Length (mm)	2000 ⁽¹⁾	200	1000	200	1000
Depth (mm)	15				
Set of	6	6 ⁽²⁾	6 ⁽²⁾	6 ⁽³⁾	6 ⁽³⁾
References	AM1DL201	AK5PC12	AK5PC32L	AK5PC12PH	AK5PC32LPH

(1) Cut and drill to suit use. (2) Total of 6 sockets supplied: 2 sockets (N + L1), 2 sockets (N + L2), 2 sockets (N + L3).

(3) Total of 6 sockets supplied: 2 sockets (L1 + L2), 2 sockets (L1 + L3), 2 sockets (L2 + L3).

(1) Découper et percer pour adapter à l'utilisation. (2) Total de 6 prises fournies : 2 prises (N + L1), 2 prises (N + L2), 2 prises (N + L3).

(3) Total de 6 prises fournies : 2 prises (L1 + L2), 2 prises (L1 + L3), 2 prises (L2 + L3).

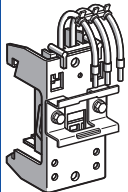
	Component mounting plates incorporating tap-off			
	Single plate (height 105 mm)			
	 AK5PA231			
Number of poles	Single-phase + Neutral			2-phase
No. of 18 mm points used on the busbar system	3			3
Rated operational current at 40° (Ie)	25 A	25 A	25 A	25 A
Phase	Ph1+N	Ph2+N	Ph3+N	Ph1+Ph2
Number of 6 rails for component support	1	1	1	1
References	AK5PA211N1	AK5PA211N2	AK5PA211N3	AK5PA211PH12

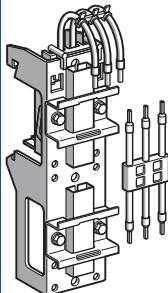
	Component mounting plates incorporating tap-off					
	Double plate (height 190 mm)					
	 AK5PA232					
Number of poles	Single-phase + Neutral			2-phase		
No. of 18 mm points used on the busbar system	3			3		
Rated operational current at 40° (Ie)	25 A	25 A	25 A	25 A	25 A	25 A
Phase	Ph1+N	Ph2+N	Ph3+N	Ph1+Ph2	Ph1+Ph3	Ph2+Ph3
Number of 6 rails for component support	2	2	2	2	2	2
References	AK5PA212N1	AK5PA212N2	AK5PA212N3	AK5PA212PH12	AK5PA212PH13	AK5PA212PH23

3-phase			3-phase + Neutral			3-phase + Common	
2			2			2	
16 A	32 A		16 A	32 A		16 A (10 Common)	32 A (10 Common)
200	250	1000	200	250	1000	200	250
6	6	6	6	6	6	6	6
AK5PC13	AK5PC33	AK5PC33L	AK5PC14	AK5PC34	AK5PC34L	AK5PC131	AK5PC331

		3-phase	3-phase + Common	3-phase + Neutral
25 A		25 A	25 A	25 A
Ph1+Ph3		Ph2+Ph3	-	-
1		1	1	1
AK5PA211PH13	AK5PA211PH23	AK5PA231	AK5PA2311	AK5PA241

3-phase			3-phase + Neutral	3-phase + Common			3-phase + Neutral
3			3	3			6
25 A	25 A	50 A	25 A	25 A (10 Common)	25 A (10 Common)	50 A (10 Common)	50 A
-			-	-			-
2			2	2			1
AK5PA232	AK5PA232S	AK5PA532	AK5PA242	AK5PA2312	AK5PA2312S	AK5PA5312	AK5PA542



P8602081

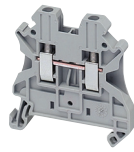

Linery TR

76

Selection guide: Screw terminal blocks	76
Selection guide: Spring terminal blocks	102
Selection guide: Push-in terminal blocks	126
Hybrid terminal blocks	138
Accessories	140
Marking accessories	142

DD381516-LIN



Linery TB

148

Earth bars	148
PE conductors	149



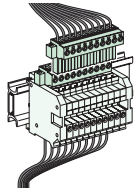



DD380867-LIN

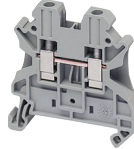

Linery TA

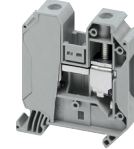
150

Auxiliary connections	150
-----------------------	-----

		Passthrough				
		Passthrough				
						
Nominal c.s.a (mm²)		2.5	4	6	10 & 16	35 to 70
Number of poles	1 - 1 x 1	NSYTRV22	NSYTRV42	NSYTRV62	NSYTRV102 NSYTRV162	NSYTRV352 NSYTRV502 NSYTRV702
	2 - 1 x 1	-	-	-	-	-
	3 - 1 x 1	-	-	-	-	-
	5 - 1 x 1	-	-	-	-	-
	10 - 1 x 1	-	-	-	-	-
	1 - 1 x 2	-	-	-	-	-
	1 - 2 x 2	-	-	-	-	-
	With LED	-	-	-	-	-
Colours	Grey	■	■	■	■	■
	Blue	NSYTRV22BL	NSYTRV42BL	NSYTRV62BL	NSYTRV102BL NSYTRV162BL	NSYTRV352BL NSYTRV502BL NSYTRV702BL
	Green/yellow (PE)	-	-	-	-	-
	Orange	NSYTRV22AR	NSYTRV42AR	-	-	-
	Red	NSYTRV22RD	NSYTRV42RD	-	-	-
	Green	-	NSYTRV42GN	-	-	-
	White	NSYTRV22WH	NSYTRV42WH	-	-	-
	Black	-	NSYTRV42BK	-	-	-
Mounting on	35 mm 	■	■	■	■	■
	35 mm 	■	■	■	■	■
	Telequick	-	-	-	-	-
	15 mm 	-	-	-	-	-
See pages	80	81	81	81	82	

PB5021070



Snap-on PE foot

Earth terminal blocks are simply snapped onto the DIN rail to make contact. This mechanically and electrically efficient connection meets all the requirements of standard IEC 60947-7-2.

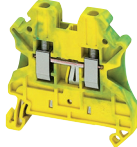
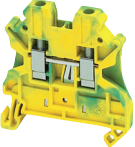
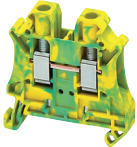
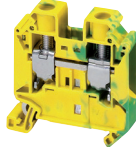
	Lug-lug Lug-connector	Protective earth							
PE602199		PE602174		PE602176		PE602175		PE602185	
	95 & 150	2.5	4	6 & 10	16 to 50				
	NSYTRV952BB NSYTRV952BC NSYTRV1502BB	NSYTRV22PE	NSYTRV42PE	NSYTRV62PE NSYTRV102PE	NSYTRV162PE NSYTRV352PE NSYTRV502PE				
	-	-	-	-	-				
	-	-	-	-	-				
	-	-	-	-	-				
	-	-	NSYTRV43PE NSYTRV44PE	-	-				
	-	-	-	-	-				
	■	-	-	-	-				
	-	-	-	-	-				
	-	■	■	■	■			■	
	-	-	-	-	-			-	
	-	-	-	-	-			-	
	-	-	-	-	-			-	
	■	■	■	■	■			■	
	■	■	■	■	■			■	
	-	-	-	-	-			-	
	-	-	-	-	-			-	
	83	84	84	84/85	85				

		Double deck		Disconnect		
		Multi-pole	Double deck	Blade	Fused	Removable carrier
Nominal c.s.a (mm²)		2.5 & 4	2.5 & 4	2.5 & 4	4 & 16	2.5 & 4
Number of poles	1 - 1 x 1	-	-	NSYTRV22SC NSYTRV22ST NSYTRV42SC NSYTRV42ST	NSYTRV42SF5 NSYTRV42SF6 NSYTRV162SF	NSYTRV22TB NSYTRV42TB
	2 - 1 x 1	-	NSYTRV24D NSYTRV44D	NSYTRV42SCD NSYTRV44SCD	-	-
	3 - 1 x 1	-	NSYTRV26T	-	-	-
	5 - 1 x 1	-	-	-	-	-
	10 - 1 x 1	-	-	-	-	-
	1 - 1 x 2	NSYTRV23 NSYTRV43	-	-	-	-
	1 - 2 x 2	NSYTRV24 NSYTRV44	NSYTRV26TC	-	-	-
	With LED	-	-	-	NSYTRV42SF5LD NSYTRV42SF6LD	-
Colours	Grey	■	■	■	-	■
	Blue	NSYTRV23BL NSYTRV24BL NSYTRV43BL NSYTRV44BL	NSYTRV24DBL NSYTRV44DBL NSYTRV26TBL	■	-	-
	Green/yellow (PE)	NSYTRV23PE NSYTRV24PE NSYTRV43PE NSYTRV44PE	NSYTRV24DPE NSYTRV44DPE	-	-	-
	Orange	-	-	NSYTRV42STAR	-	-
	Red	-	-	-	-	-
	Green	-	-	-	-	-
	White	-	-	-	-	-
	Black	-	-	-	■	-
Mounting on	35 mm	■	■	■	■	■
	35 mm	■	■	■	■	■
	Telequick	-	-	-	-	-
	15 mm	-	-	-	-	-
See pages		86/87/90/91	87/88	92/93	94	93

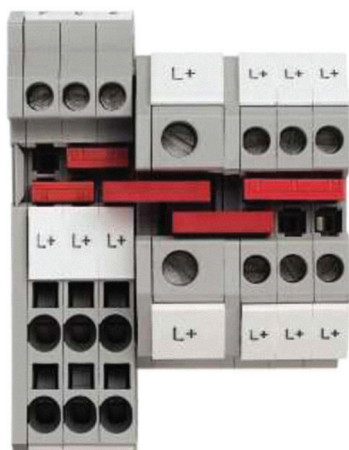

PB602411-50



Flexible plug-in bridge system

The **NSYTRAL*** plug-in bridges allow potential distribution to be implemented quickly. All terminals have two bridge shafts to make flexible chain bridging, step bridging or bridging between nonadjacent terminal blocks possible.

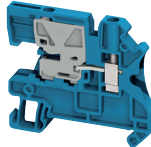
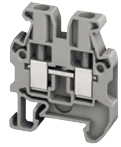
The reducing bridge permits simple connection of terminal blocks with different nominal cross-sections, (e.g. an **NSYTRV102** terminal connected to an **NSYTRV22** terminal). This way the power distribution terminal blocks can be quickly setup.

Measuring		For neutral conductors		Miniature		DB6			
				Passthrough		With Telequick universal foot			
 <small>PE602206</small>	 <small>PE602221</small>	 <small>PE602751-20</small>	 <small>PE601874-18</small>	6	4 to 10	2.5 & 4	4	6	35
NSYTRV62TTD	NSYTRV42NE NSYTRV62NE	NSYTRV22M NSYTRV42M	-	-	-	-	-	-	DB6FD01
-	-	-	DB6CD102	DB6DD102	-	-	-	-	-
-	-	-	-	DB6DD103	-	-	-	-	-
-	-	-	DB6CD105	-	-	-	-	-	-
-	-	-	DB6CD110	-	-	-	-	-	-
-	-	-	-	-	-	-	-	-	-
-	-	-	-	-	-	-	-	-	-
■	-	■	■	■	■	■	■	■	■
-	■	NSYTRV22MBL NSYTRV42MBL	-	-	-	-	-	-	-
NSYTRV62TTPE	-	NSYTRV22MPE NSYTRV42MPE	-	-	-	-	-	-	-
-	-	-	-	-	-	-	-	-	-
-	-	-	-	-	-	-	-	-	-
-	-	-	-	-	-	-	-	-	-
-	-	-	-	-	-	-	-	-	-
■	■	-	■	■	■	■	■	■	■
■	■	-	■	■	■	■	■	■	■
-	-	-	■	■	■	■	■	■	■
-	-	■	-	-	-	-	-	-	-
96/97	98	100/101	-	-	-	-	-	-	-

Screw terminal blocks - Passthrough

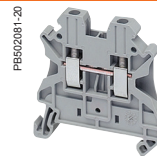

		NSYTRV22			
Nominal c.s.a.	Type of block	Passthrough			
	Type of connection	1 pole - 1 x 1			
	Colour	Grey			
	Max. electric values (U _{max} , I _{max})	1000 V, 32 A			
Dimensions (mm)					
	Length	47.7			
	Height	47.5			
	Width	5.2			
Cabling c.s.a. (mm ²)		2.5			
	Flexible cable	0.14 - 4			
	Solid cable	0.14 - 4			
Nominal electric values					
	IEC/EN 60947-7-1	1000 V, 24 A			
	UL	600 V, 20 A, 26 - 12 AWG			
	CSA	600 V, 20 A, 26 - 12 AWG			
	ATEX	690 V, 22 A			
Certifications		UL, CSA, VDE, ATEX, IECEx, GL, LR, DNV, EAC			
Terminal blocks					
	Grey	Sold in lots of	Unit reference		
	Blue	50	NSYTRV22		
	Orange	50	NSYTRV22BL		
	Red	50	NSYTRV22AR		
	Green	-	NSYTRV22RD		
	White	50	-		
	Black	-	NSYTRV22WH		
	Brown	-	-		
	Yellow	-	-		
Accessories					
1	End stop	Clip-on, 5.2 mm	50	NSYTRAAB35	
2	for 35 mm DIN rail	With screw, 9.5 mm	50	NSYTRAABV35	
3	End plate	Grey	50	NSYTRAC22	
		width 2.2 mm Blue	50	NSYTRAC22BL	
4	Partition plate, width 2 mm	Grey	50	NSYTRAP22	
		Blue	50	NSYTRAP22BL	
5	Plug-in bridge	Red	2-pole	50	NSYTRAL22
			3-pole	50	NSYTRAL23
			4-pole	50	NSYTRAL24
			5-pole	50	NSYTRAL25
			10-pole	10	NSYTRAL210
			20-pole	10	NSYTRAL220
			Blue	10-pole	10
	Grey	10-pole	10	NSYTRAL210GR	
6	Step-down bridge, down to 2.5/4 mm ²	Screw to screw terminal	-	-	
		Screw to spring terminal	-	-	
	Vertical bridge	1-pole	-	-	
7	Pick-off terminal	Grey	-	-	
8	Test plug	Metallic part, Ø 2.3 mm	10	NSYTRAATM1	
		Insulating sleeve, red	10	NSYTRAATP1	
9	Test adaptor	For plug-in bridge shaft	10	NSYTRAFT	
10	Warning label	Yellow	10	NSYTRACS2	
11	Marker tag holder	For ●AB35 end stop	100	NSYTRASB4	
12	DIN rail 35 x 7.2 mm	Perforated, 2 m long	20	NSYSDR200BD	
13	Marking accessories		See page 142		
General data					
	Strip length (mm)	9			
	Screw thread	M3			
	Torque (Nm)	0.5 - 0.6			

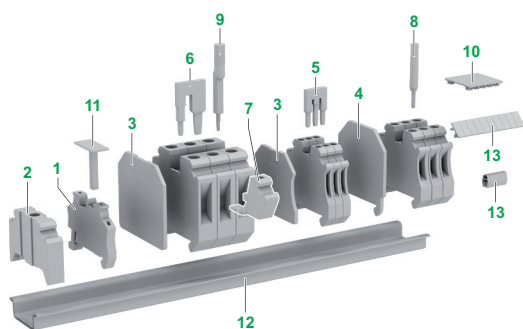

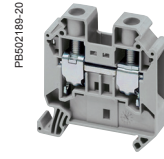
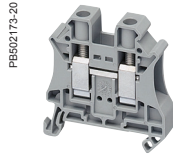
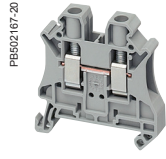
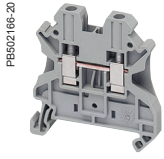

NSYTRV42	NSYTRV62	NSYTRV102	NSYTRV162
4 mm ²	6 mm ²	10 mm ²	16 mm ²
Passthrough	Passthrough	Passthrough	Passthrough
1 pole - 1 x 1	1 pole - 1 x 1	1 pole - 1 x 1	1 pole - 1 x 1
Grey	Grey	Grey	Grey
1000 V, 41 A	1000 V, 57 A	1000 V, 76 A	1000 V, 101 A
47.7	47.7	47.7	55.5
47.5	47.5	47.5	55
6.2	8.2	10.2	12.2
4	6	10	16
0.14 - 6	0.2 - 10	0.5 - 16	1.5 - 25
0.14 - 6	0.2 - 10	0.5 - 16	1.5 - 25

1000 V, 32 A	1000 V, 41 A	1000 V, 57 A	1000 V, 76 A
600 V, 30 A, 26 - 10 AWG	600 V, 50 A, 24 - 8 AWG	600 V, 65 A, 20 - 6 AWG	600 V, 85 A, 16 - 4 AWG
600 V, 30 A, 26 - 10 AWG	600 V, 50 A, 24 - 8 AWG	600 V, 65 A, 20 - 6 AWG	600 V, 85 A, 16 - 4 AWG
690 V, 30 A	690 V, 40 A	690 V, 54 A	690 V, 73 A
UL, CSA, VDE, ATEX, IECEX, GL, LR, DNV, EAC	UL, CSA, VDE, ATEX, IECEX, GL, LR, DNV, EAC	UL, CSA, VDE, ATEX, IECEX, GL, LR, DNV, EAC	UL, CSA, VDE, ATEX, IECEX, GL, LR, DNV, EAC

Sold in lots of	Unit reference	Sold in lots of	Unit reference	Sold in lots of	Unit reference	Sold in lots of	Unit reference
50	NSYTRV42	50	NSYTRV62	50	NSYTRV102	50	NSYTRV162
50	NSYTRV42BL	50	NSYTRV62BL	50	NSYTRV102BL	50	NSYTRV162BL
50	NSYTRV42AR	-	-	-	-	-	-
50	NSYTRV42RD	-	-	-	-	-	-
-	NSYTRV42GN	-	-	-	-	-	-
50	NSYTRV42WH	-	-	-	-	-	-
-	NSYTRV42BK	-	-	-	-	-	-
-	NSYTRV42BR	-	-	-	-	-	-
-	NSYTRV42YE	-	-	-	-	-	-

50	NSYTRAAB35	50	NSYTRAAB35	50	NSYTRAAB35	50	NSYTRAAB35
50	NSYTRAABV35	50	NSYTRAABV35	50	NSYTRAABV35	50	NSYTRAABV35
50	NSYTRAC22	50	NSYTRAC22	50	NSYTRAC22	50	NSYTRAC162
50	NSYTRAC22BL	50	NSYTRAC22BL	50	NSYTRAC22BL	-	-
50	NSYTRAP22	50	NSYTRAP22	50	NSYTRAP22	-	-
50	NSYTRAP22BL	50	NSYTRAP22BL	50	NSYTRAP22BL	-	-
50	NSYTRAL42	10	NSYTRAL62	10	NSYTRAL102	10	NSYTRAL162
50	NSYTRAL43	10	NSYTRAL63	-	-	-	-
50	NSYTRAL44	-	-	-	-	-	-
50	NSYTRAL45	10	NSYTRAL65	-	-	-	-
10	NSYTRAL410	10	NSYTRAL610	-	-	-	-
10	NSYTRAL420	-	-	-	-	-	-
10	NSYTRAL410BL	10	NSYTRAL610BL	-	-	-	-
10	NSYTRAL410GR	10	NSYTRAL610GR	-	-	-	-
-	-	10	NSYTRALV62	10	NSYTRALV102	10	NSYTRALV162
-	-	10	NSYTRALVR62	10	NSYTRALVR102	10	NSYTRALVR162
-	-	-	-	-	-	-	-
-	-	-	-	-	-	10	NSYTRAPT16
10	NSYTRAATM1	10	NSYTRAATM1	10	NSYTRAATM1	10	NSYTRAATM1
10	NSYTRAATP1	10	NSYTRAATP1	10	NSYTRAATP1	10	NSYTRAATP1
10	NSYTRAFT	10	NSYTRAFT	-	-	-	-
10	NSYTRACS4	10	NSYTRACS6	10	NSYTRACS10	10	NSYTRACS16
100	NSYTRASB4	100	NSYTRASB4	100	NSYTRASB4	100	NSYTRASB4
20	NSYSR200BD	20	NSYSR200BD	20	NSYSR200BD	20	NSYSR200BD

9		10		10		14	
M3		M4		M4		M5	
0.6 - 0.8		1.5 - 1.8		1.5 - 1.8		2.5 - 3	

*Screw bridge

Screw terminal blocks - Passthrough

PB602190-20

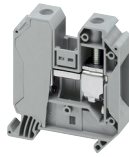

PB602194-20

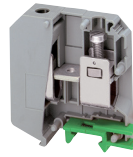

PB602311-20

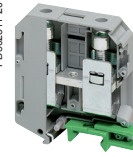

		NSYTRV352	NSYTRV502	NSYTRV702			
Nominal c.s.a.		35 mm ²	50 mm ²	70 mm ²			
	Type of block	Passthrough	Passthrough	Passthrough			
	Type of connection	1 pole - 1 x 1	1 pole - 1 x 1	1 pole - 1 x 1			
	Colour	Grey	Grey	Grey			
Max. electric values (U _{max} , I _{max})		1000 V, 125 A	1000 V, 150 A	1000 V, 192 A			
Dimensions (mm)							
	Length	60.2	70.5	70.5			
	Height	65.7	83.5	87.5			
	Width	16	20	20.3			
Cabling c.s.a. (mm ²)		35	50	70			
	Flexible cable	1.5 - 50	25 - 70	25 - 70			
	Solid cable	1.5 - 50	16 - 70	16 - 95			
Nominal electric values							
	IEC/EN 60947-7-1	1000 V, 125 A	1000 V, 150 A	1000 V, 192 A			
	UL	600 V, 150 A, 14 - 1/0 AWG	600 V, 150 A, 6 - 1/0 AWG	600 V, 192 A, 4 - 3/0 AWG			
	CSA	600 V, 150 A, 14 - 1/0 AWG	600 V, 150 A, 6 - 1/0 AWG	600 V, 192 A, 4 - 3/0 AWG			
	ATEX	690 V, 126 A	690 V, 137 A	-			
Certifications		UL, CSA, VDE, ATEX, IECEx, GL, EAC	UL, CSA, VDE, ATEX, IECEx, GL, LR, DNV, EAC	UL, CSA, VDE, GL, LR, DNV, EAC			
Terminal blocks							
		Sold in lots of	Unit reference	Sold in lots of	Unit reference	Sold in lots of	Unit reference
	Grey	50	NSYTRV352	10	NSYTRV502	10	NSYTRV702
	Blue	50	NSYTRV352BL	10	NSYTRV502BL	10	NSYTRV702BL
	Orange	-	-	-	-	-	-
	Red	-	-	-	-	-	-
	Green	-	-	-	-	-	-
	White	-	-	-	-	-	-
	Black	-	-	-	-	-	-
Accessories							
End stop	Clip-on, 5.2 mm	50	NSYTRAAB35	50	NSYTRAAB35	50	NSYTRAAB35
for 35 mm DIN rail	With screw, 9.5 mm	50	NSYTRAABV35	50	NSYTRAABV35	50	NSYTRAABV35
End plate,	Grey	-	Included	-	Included	-	Included
width 2.2 mm	Blue	-	-	-	-	-	-
Partition plate,	Grey	-	-	-	-	-	-
width 2 mm	Blue	-	-	-	-	-	-
Plug-in bridge	2-pole	10	NSYTRAL352	10	NSYTRAL502*	-	-
Red	3-pole	-	-	10	NSYTRAL503*	-	-
	4-pole	-	-	-	-	-	-
	5-pole	-	-	-	-	-	-
	10-pole	-	-	-	-	-	-
	20-pole	-	-	-	-	-	-
Blue	10-pole	-	-	-	-	-	-
Grey	10-pole	-	-	-	-	-	-
Screw bridge	2-pole	-	-	-	-	10	NSYTRAL702
Step-down bridge,	Screw to screw terminal	10	NSYTRALV352	-	-	-	-
down to 2.5/4 mm ²	Screw to spring terminal	10	NSYTRALVR352	-	-	-	-
Vertical bridge	1-pole	-	-	-	-	-	-
Pick-off terminal	Grey	10	NSYTRAPT35	-	-	-	-
Test plug	Metallic part, Ø 2.3 mm	10	NSYTRAATM1	10	NSYTRAATM1	10	NSYTRAATM1
	Insulating sleeve, red	10	NSYTRAATP1	10	NSYTRAATP1	10	NSYTRAATP1
Test adaptor	For plug-in bridge shaft	-	-	-	-	-	-
Warning label	Yellow	10	NSYTRAC35	-	-	-	-
Marker tag holder	For ●AB35 end stop	100	NSYTRASB4	100	NSYTRASB4	100	NSYTRASB4
DIN rail 35 x 7.2 mm	Perforated, 2 m long	20	NSYSR200BD	20	NSYSR200BD	20	NSYSR200BD
Marking accessories		See page 142					
General data							
	Strip length (mm)	18	24	24			
	Screw thread	M6	M6	M8			
	Torque (Nm)	3.2 - 3.7	6 - 8	08 - 10			

*Screw bridge

Screw terminal blocks - High current

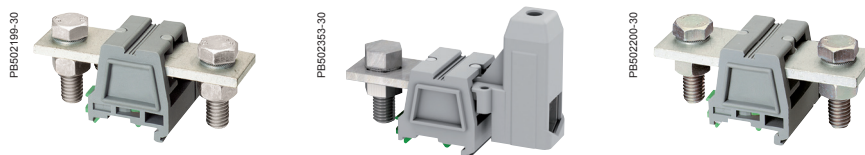

		NSYTRV952BB	NSYTRV952BC	NSYTRV1502BB			
Nominal c.s.a.		95 mm ²	95 mm ²	150 mm ²			
	Type of block	Passthrough - lug to lug	Passthrough - lug to connector	Passthrough - lug to lug			
	Type of connection	1 pole - 1 x 1	1 pole - 1 x 1	1 pole - 1 x 1			
	Color	Grey	Grey	Grey			
Max. electric values		1000 V, 232 A	1000 V, 232 A	1000 V, 309 A			
Dimensions (mm)							
Length		110	114	119			
Height		56	86	100			
Width		40	40	46			
Cabling c.s.a. (mm ²)		95	95	150			
	Flexible cable	35 - 95	35 - 95	50 - 150			
	Solid cable	25 - 95	25 - 95	35 - 150			
Nominal electric values							
IEC/EN 60947-7-1		1000 V, 232 A	1000 V, 232 A	1000 V, 309 A			
UL		600 V, 230 A, 2 - 4/0 AWG	600 V, 230 A, 2 - 4/0 AWG	600 V, 285 A, 2 - 300 AWG/kcmil			
CSA		600 V, 230 A, 2 - 4/0 AWG	600 V, 230 A, 2 - 4/0 AWG	600 V, 285 A, 2 - 300 AWG/kcmil			
ATEX Ⓜ		-	-	-			
Certifications		UL, CSA, GL, EAC	UL, CSA, GL, EAC	UL, CSA, GL			
Terminal blocks							
		Sold in lots of	Unit reference	Sold in lots of	Unit reference	Sold in lots of	Unit reference
Grey Blue		10	NSYTRV952BB	10	NSYTRV952BC	10	NSYTRV1502BB
		-	-	-	-	-	-
Accessories							
End stop	Clip-on, 5.2 mm	50	NSYTRAAB35	50	NSYTRAAB35	50	NSYTRAAB35
for 35 mm DIN rail	With screw, 9.5 mm	50	NSYTRAABV35	50	NSYTRAABV35	50	NSYTRAABV35
End plate	Grey	-	-	-	-	-	-
Partition plate	Grey	10	NSYTRAC952	10	NSYTRAC952	10	NSYTRAC952
Screw bridge	2-pole	10	NSYTRAL952	10	NSYTRAL952	10	NSYTRAL1502
	3-pole	-	-	-	-	-	-
Test plug	Metalic part, Ø 2.3 mm	10	NSYTRAATM1	10	NSYTRAATM1	10	NSYTRAATM1
	Insulating sleeve, red	10	NSYTRAATP1	10	NSYTRAATP1	10	NSYTRAATP1
Test adaptor	For plug-in bridge shaft	-	-	-	-	-	-
Cover	Grey	10	NSYTRACP1	10	NSYTRACP1	10	NSYTRACP2
Marker tag holder	For ●AB35 end stop	100	NSYTRASB4	100	NSYTRASB4	100	NSYTRASB4
DIN rail 35 x 7.2 mm	Perforated, 2 m long	20	NSYS DR200BD	20	NSYS DR200BD	20	NSYS DR200BD
Marking accessories		See page 142					
General data							
Strip length (mm)		29		29		29	
Screw thread		M12		M8 / M12		M12	
Torque (Nm)		25 - 30		15 - 20 / 25 - 30		25 - 30	

Screw terminal blocks - Protective earth

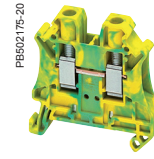
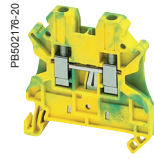
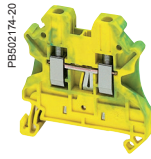

		NSYTRV22PE	NSYTRV42PE	NSYTRV62PE			
Nominal c.s.a.		2.5 mm ²	4 mm ²	6 mm ²			
	Type of block	Protective earth	Protective earth	Protective earth			
	Type of connection	1 pole - 1 x 1	1 pole - 1 x 1	1 pole - 1 x 1			
	Colour	Green/Yellow	Green/Yellow	Green/Yellow			
Max. electric values		-	-	-			
Dimensions (mm)							
	Length	47.7	47.7	47.7			
	Height	47.5	47.5	47.5			
	Width	5.2	6.2	8.2			
Cabling c.s.a. (mm ²)		2.5	4	6			
	Flexible cable	0.14 - 4	0.14 - 6	0.2 - 10			
	Solid cable	0.14 - 4	0.14 - 6	0.2 - 10			
Nominal electric values							
	IEC/EN 60947-7-1	-	-	-			
	UL	26 - 12 AWG	26 - 10 AWG	24 - 8 AWG			
	CSA	26 - 12 AWG	26 - 10 AWG	24 - 8 AWG			
	ATEX	-	-	-			
Certifications		UL, CSA, VDE, ATEX, IECEx, GL, LR; DNV, EAC	UL, CSA, VDE, ATEX, IECEx, GL, LR, DNV, EAC	UL, CSA, VDE, ATEX, IECEx, GL, LR, DNV, EAC			
Terminal blocks							
	Green/Yellow	Sold in lots of 50	Unit reference NSYTRV22PE	Sold in lots of 50	Unit reference NSYTRV42PE	Sold in lots of 50	Unit reference NSYTRV62PE
Accessories							
End stop for 35 mm DIN rail	Clip-on, 5.2 mm	50	NSYTRAAB35	50	NSYTRAAB35	50	NSYTRAAB35
	With screw, 9.5 mm	50	NSYTRAABV35	50	NSYTRAABV35	50	NSYTRAABV35
End plate, width 2.2 mm	Grey	50	NSYTRAC22	50	NSYTRAC22	50	NSYTRAC22
	Blue	50	NSYTRAC22BL	50	NSYTRAC22BL	50	NSYTRAC22BL
Partition plate, width 2 mm	Grey	50	NSYTRAP22	50	NSYTRAP22	50	NSYTRAP22
	Blue	50	NSYTRAP22BL	50	NSYTRAP22BL	50	NSYTRAP22BL
Plug-in bridge Red	2-pole	50	NSYTRAL22	50	NSYTRAL42	10	NSYTRAL62
	3-pole	50	NSYTRAL23	50	NSYTRAL43	10	NSYTRAL63
	4-pole	50	NSYTRAL24	50	NSYTRAL44	-	-
	5-pole	50	NSYTRAL25	50	NSYTRAL45	10	NSYTRAL65
	10-pole	10	NSYTRAL210	10	NSYTRAL410	10	NSYTRAL610
Test plug	20-pole	10	NSYTRAL220	10	NSYTRAL420	-	-
	Metallic part, Ø 2.3 mm	10	NSYTRAATM1	10	NSYTRAATM1	10	NSYTRAATM1
	Insulating sleeve, red	10	NSYTRAATP1	10	NSYTRAATP1	10	NSYTRAATP1
Test adaptor	For plug-in bridge shaft	10	NSYTRAFT	10	NSYTRAFT	10	NSYTRAFT
Warning label	Yellow	10	NSYTRACS2	10	NSYTRACS4	10	NSYTRACS6
Marker tag holder	For AB35 end stop	100	NSYTRASB4	100	NSYTRASB4	100	NSYTRASB4
DIN rail 35 x 7.2 mm	Perforated, 2 m long	20	NSYSR200BD	20	NSYSR200BD	20	NSYSR200BD
Marking accessories		See page 142					
General data							
	Strip length (mm)	9	9	9	10	10	10
	Screw thread	M3	M3	M3	M4	M4	M4
	Torque (Nm)	0.5 - 0.6	0.5 - 0.6	0.6 - 0.8	1.5 - 1.8	1.5 - 1.8	1.5 - 1.8

PB502106-20

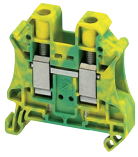

PB502106-20

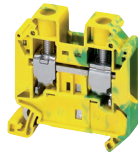

PB502177-20

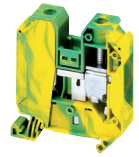

PB502106-20

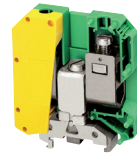

NSYTRV102PE		NSYTRV162PE		NSYTRV352PE		NSYTRV502PE	
10 mm ²		16 mm ²		35 mm ²		50 mm ²	
Protective earth		Protective earth		Protective earth		Protective earth	
1 pole - 1 x 1		1 pole - 1 x 1		1 pole - 1 x 1		1 pole - 1 x 1	
Green/Yellow		Green/Yellow		Green/Yellow		Green/Yellow	
-		-		-		-	
47.7		55		65.7		70.5	
47.5		55.5		60.2		83.5	
10.2		12.2		16		20	
10		16		35		50	
0.5 - 16		1.5 - 25		1.5 - 35		25 - 70	
0.5 - 16		1.5 - 25		1.5 - 35		16 - 70	
76 A		101 A		125 A		150 A	
20 - 6 AWG		16 - 4 AWG		14 - 1/0 AWG		6 - 1/0 AWG	
20 - 6 AWG		16 - 4 AWG		14 - 1/0 AWG		6 - 1/0 AWG	
-		-		-		-	
UL, CSA, VDE, ATEX, IECEx, GL, LR; DNV, EAC		UL, CSA, VDE, ATEX, IECEx, GL, LR, DNV, EAC		UL, CSA, VDE, ATEX, IECEx, GL, EAC		UL, CSA, ATEX, IECEx, GL, LR, DNV, EAC	
Sold in lots of	Unit reference	Sold in lots of	Unit reference	Sold in lots of	Unit reference	Sold in lots of	Unit reference
50	NSYTRV102PE	50	NSYTRV162PE	50	NSYTRV352PE	50	NSYTRV502PE
50	NSYTRAAB35	50	NSYTRAAB35	50	NSYTRAAB35	50	NSYTRAAB35
50	NSYTRAABV35	50	NSYTRAABV35	50	NSYTRAABV35	50	NSYTRAABV35
50	NSYTRAC22	50	NSYTRAC162	-	Included	-	Included
50	NSYTRAC22BL	-	-	-	-	-	-
50	NSYTRAP22	-	-	-	-	-	-
50	NSYTRAP22BL	-	-	-	-	-	-
10	NSYTRAL102	10	NSYTRAL162	10	NSYTRAL352	-	-
-	-	-	-	-	-	-	-
-	-	-	-	-	-	-	-
-	-	-	-	-	-	-	-
-	-	-	-	-	-	-	-
10	NSYTRAATM1	10	NSYTRAATM1	10	NSYTRAATM1	10	NSYTRAATM1
10	NSYTRAATP1	10	NSYTRAATP1	10	NSYTRAATP1	10	NSYTRAATP1
-	-	-	-	-	-	-	-
10	NSYTRACS10	10	NSYTRACS16	10	NSYTRACS35	-	-
100	NSYTRASB4	100	NSYTRASB4	100	NSYTRASB4	100	NSYTRASB4
20	NSYSR200BD	20	NSYSR200BD	20	NSYSR200BD	20	NSYSR200BD
10		14		18		24	
M4		M5		M6		M6	
1.5 - 1.8		2.5 - 3		3.2 - 3.7		6 - 8	

Screw terminal blocks - Double deck passthrough

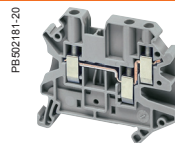

		NSYTRV23
Nominal c.s.a.		2.5 mm ²
	Type of block	Passthrough - Multi-pole
	Type of connection	1 pole - 1 x 2
	Colour	Grey
Max. electric values (U _{max} , I _{max})		500 V, 30 A
Dimensions (mm)		
	Length	57.8
	Height	47.5
	Width	5.2
Cabling c.s.a. (mm ²)		2.5
	Flexible cable	0.14 - 4
	Solid cable	0.14 - 4
Nominal electric values		
	IEC/EN 60947-7-1	500 V, 24 A
	UL	150 V, 20 A, 26 - 12 AWG
	CSA	150 V, 20 A, 26 - 12 AWG
	ATEX	352 V, 21 A
Certifications		UL, CSA, ATEX, IECEx, EAC

Terminal blocks		Sold in lots of	Unit reference
	Grey	50	NSYTRV23
	Blue	50	NSYTRV23BL

Accessories			
1	End stop	Clip-on, 5.2 mm	50 NSYTRAAB35
2	for 35 mm DIN rail	With screw, 9.5 mm	50 NSYTRAABV35
3	End plate,	Grey	50 NSYTRAC23
3	width 2.2 mm	Grey, partial plate	- -
4	Partition plate,	Grey	50 NSYTRAP23
	width 2 mm	Blue	- -
5	Plug-in bridge	2-pole	50 NSYTRAL22
		3-pole	50 NSYTRAL23
		4-pole	50 NSYTRAL24
		5-pole	50 NSYTRAL25
		10-pole	10 NSYTRAL210
	20-pole	10 NSYTRAL220	
6	Vertical bridge	1-pole	- -
8	Test plug	Metallic part, Ø 2.3 mm	10 NSYTRAATM1
		Insulating sleeve, red	10 NSYTRAATP1
9	Test adaptor	For plug-in bridge shaft	10 NSYTRAPT
10	Warning label	Yellow	10 NSYTRACS2
11	Marker tag holder	For ●AB35 end stop	100 NSYTRASB4
12	DIN rail 35 x 7.2 mm	Perforated, 2 m long	20 NSYSDR200BD
13	Marking accessories		See page 142

General data		
	Strip length (mm)	9
	Screw thread	M3
	Torque (Nm)	0.5 - 0.6

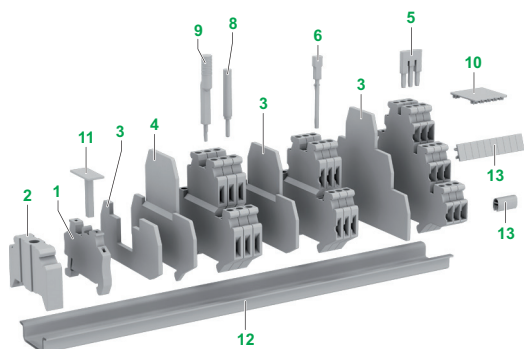

PB62183-20

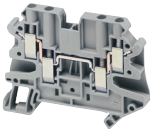

PB62181-20

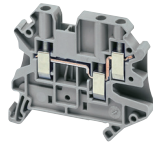

PB62183-20

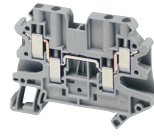

PB62187-20

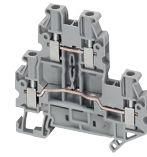

NSYTRV24		NSYTRV43		NSYTRV44		NSYTRV24D	
2.5 mm ²		4 mm ²		4 mm ²		2.5 mm ²	
Passthrough - Multi-pole		Passthrough - Multi-pole		Passthrough - Multi-pole		Passthrough - Double deck	
1 pole - 2 x 2		1 pole - 1 x 2		1 pole - 2 x 2		2 pole - 1 x 1	
Grey		Grey		Grey		Grey	
500 V, 30 A		500 V, 41 A		500 V, 39 A		500 V, 28 A	
65.4		57.8		65.4		69.9	
47.5		47.5		47.5		65	
5.2		6.2		6.2		5.2	
2.5		4		4		2.5	
0.14 - 4		0.14 - 6		0.14 - 6		0.14 - 4	
0.14 - 4		0.14 - 6		0.14 - 6		0.14 - 4	
500 V, 24 A		500 V, 32 A		500 V, 32 A		500 V, 24 A	
150 V, 20 A, 26 - 12 AWG		150 V, 30 A, 26 - 10 AWG		150 V, 30 A, 26 - 10 AWG		600 V, 20 A, 26 - 12 AWG	
150 V, 20 A, 26 - 12 AWG		150 V, 30 A, 26 - 10 AWG		150 V, 30 A, 26 - 10 AWG		600 V, 20 A, 26 - 12 AWG	
352 V, 21 A		352 V, 29 A		352 V, 29 A		352 V, 20 A	
UL, CSA, ATEX, IECEx, EAC		UL, CSA, ATEX, IECEx, GL, LR, DNV, EAC		UL, CSA, ATEX, IECEx, GL, LR, DNV, EAC		UL, CSA, ATEX, IECEx, GL, LR, DNV, EAC	
Sold in lots of	Unit reference	Sold in lots of	Unit reference	Sold in lots of	Unit reference	Sold in lots of	Unit reference
50	NSYTRV24	50	NSYTRV43	50	NSYTRV44	50	NSYTRV24D
50	NSYTRV24BL	50	NSYTRV43BL	50	NSYTRV44BL	50	NSYTRV24DBL
50	NSYTRAAB35	50	NSYTRAAB35	50	NSYTRAAB35	50	NSYTRAAB35
50	NSYTRAABV35	50	NSYTRAABV35	50	NSYTRAABV35	50	NSYTRAABV35
50	NSYTRAC24	50	NSYTRAC23	50	NSYTRAC24	50	NSYTRAC24
-	-	-	-	-	-	50	NSYTRACEP24
50	NSYTRAP24	50	NSYTRAP23	50	NSYTRAP24	50	NSYTRAPE24
-	-	-	-	-	-	-	-
50	NSYTRAL22	50	NSYTRAL42	50	NSYTRAL42	50	NSYTRAL22
50	NSYTRAL23	50	NSYTRAL43	50	NSYTRAL43	50	NSYTRAL23
50	NSYTRAL24	50	NSYTRAL44	50	NSYTRAL44	50	NSYTRAL24
50	NSYTRAL25	50	NSYTRAL45	50	NSYTRAL45	50	NSYTRAL25
10	NSYTRAL210	10	NSYTRAL410	10	NSYTRAL410	10	NSYTRAL210
10	NSYTRAL220	10	NSYTRAL420	10	NSYTRAL420	10	NSYTRAL220
-	-	-	-	-	-	50	NSYTRALV24
10	NSYTRAATM1	10	NSYTRAATM1	10	NSYTRAATM1	10	NSYTRAATM1
10	NSYTRAATP1	10	NSYTRAATP1	10	NSYTRAATP1	10	NSYTRAATP1
10	NSYTRAFT	10	NSYTRAFT	10	NSYTRAFT	10	NSYTRAFT
10	NSYTRACS2	10	NSYTRACS4	10	NSYTRACS4	10	NSYTRACS2
100	NSYTRASB4	100	NSYTRASB4	100	NSYTRASB4	100	NSYTRASB4
20	NSYSDR200BD	20	NSYSDR200BD	20	NSYSDR200BD	20	NSYSDR200BD
9		9		9		9	
M3		M3		M3		M3	
0.5 - 0.6		0.6 - 0.8		0.6 - 0.8		0.5 - 0.6	

Screw terminal blocks - Double deck passthrough

PB62108-20

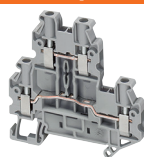

PB62215-20

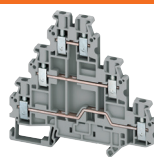

PB62768-22

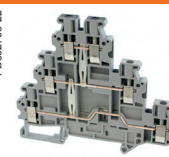

	NSYTRV44D	NSYTRV26T	NSYTRV26TC				
Nominal c.s.a.	4 mm ²	2.5 mm ²	2.5 mm ²				
Type of block	Passthrough - Double deck	Passthrough - Triple deck	Passthrough - 3 Levels				
Type of connection	2 pole - 1 x 1	3 pole - 1 x 1	1 pole - 3 x 3				
Colour	Grey	Grey	Grey				
Max. electric values (Umax, Imax)	800 V, 36 A	500 V, 24 A	500 V, 24 A				
Dimensions (mm)							
Length	69.9	90	90				
Height	65	77.5	77.5				
Width	6.2	5.2	5.2				
Cabling c.s.a. (mm ²)	4	2.5	2.5				
Flexible cable	0.14 - 6	0.14 - 4	0.14 - 4				
Solid cable	0.14 - 6	0.14 - 4	0.14 - 4				
Nominal electric values							
IEC/EN 60947-7-1	800 V, 30 A	500 V, 20 A	500 V, 20 A				
UL	600 V, 30 A, 26 - 10 AWG	600 V, 20 A, 26 - 12 AWG	600 V, 20 A, 26 - 12 AWG				
CSA	600 V, 30 A, 26 - 10 AWG	600 V, 20 A, 26 - 12 AWG	-				
ATEX	440 V, 25.5 A	-	-				
Certifications	UL, CSA, ATEX, IECEX, GL, LR, DNV, EAC	UL, CSA, EAC	UL, EAC				
Terminal blocks							
	Sold in lots of	Unit reference	Sold in lots of	Unit reference	Sold in lots of	Unit reference	
Grey	50	NSYTRV44D	50	NSYTRV26T	50	NSYTRV26TC*	
Blue	50	NSYTRV44DBL	50	NSYTRV26TBL	-	-	
Accessories							
End stop	Clip-on, 5.2 mm	50	NSYTRAAB35	50	NSYTRAAB35	50	NSYTRAAB35
for 35 mm DIN rail	With screw, 9.5 mm	50	NSYTRAABV35	50	NSYTRAABV35	50	NSYTRAABV35
End plate,	Grey	50	NSYTRACE24	50	NSYTRACE26	50	NSYTRACE26
width 2.2 mm	Grey, partial plate	50	NSYTRACEP24	-	-	-	-
Partition plate,	Grey	50	NSYTRAPE24	-	-	-	-
width 2 mm	Blue	-	-	-	-	-	-
Plug-in bridge	2-pole	50	NSYTRAL42	50	NSYTRAL22	50	NSYTRAL22
Red	3-pole	50	NSYTRAL43	50	NSYTRAL23	50	NSYTRAL23
	4-pole	50	NSYTRAL44	50	NSYTRAL24	50	NSYTRAL24
	5-pole	50	NSYTRAL45	50	NSYTRAL25	50	NSYTRAL25
	10-pole	10	NSYTRAL410	10	NSYTRAL210	10	NSYTRAL210
	20-pole	10	NSYTRAL420	10	NSYTRAL220	10	NSYTRAL220
Vertical bridge	1-pole	50	NSYTRALV24	-	-	-	-
Test plug	Metallic part, Ø 2.3 mm	10	NSYTRAATM1	10	NSYTRAATM1	10	NSYTRAATM1
	Insulating sleeve, red	10	NSYTRAATP1	10	NSYTRAATP1	10	NSYTRAATP1
Test adaptor	For plug-in bridge shaft	10	NSYTRAPT	10	NSYTRAPT	10	NSYTRAPT
Warning label	Yellow	10	NSYTRACS4	10	NSYTRACS2	10	NSYTRACS2
Marker tag holder	For ●AB35 end stop	100	NSYTRASB4	100	NSYTRASB4	100	NSYTRASB4
DIN rail 35 x 7.2 mm	Perforated, 2 m long	20	NSYSDR200BD	20	NSYSDR200BD	20	NSYSDR200BD
Marking accessories	See page 142						
General data							
Strip length (mm)	9	9	9				
Screw thread	M3	M3	M3				
Torque (Nm)	0.6 - 0.8	0.5 - 0.6	0.5 - 0.6				

* The 3 levels are connected.



Screw terminal blocks - Double deck protective earth

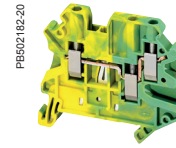
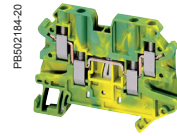
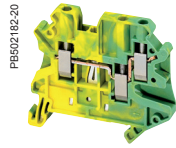

		NSYTRV23PE	NSYTRV24PE	NSYTRV43PE			
Nominal c.s.a.		2.5 mm ²	2.5 mm ²	4 mm ²			
	Type of block	Protective earth - Multi-pole	Protective earth - Multi-pole	Protective earth - Multi-pole			
	Type of connection	1 pole - 1 x 2	1 pole - 2 x 2	1 pole - 1 x 2			
	Colour	Green/Yellow	Green/Yellow	Green/Yellow			
Max. electric values		-	-	-			
Dimensions (mm)							
	Length	57.8	65.4	57.8			
	Height	47.5	47.5	47.5			
	Width	5.2	5.2	6.2			
Cabling c.s.a. (mm ²)		2.5	2.5	4			
	Flexible cable	0.14 - 4	0.14 - 4	0.14 - 6			
	Solid cable	0.14 - 4	0.14 - 4	0.14 - 6			
Nominal electric values							
	IEC/EN 60947-7-1	-	-	-			
	UL	26 - 12 AWG	26 - 12 AWG	26 - 10 AWG			
	CSA	26 - 12 AWG	26 - 12 AWG	26 - 10 AWG			
	ATEX	-	-	-			
Certifications		UL, CSA, ATEX, IECEx, EAC	UL, CSA, ATEX, IECEx, EAC	UL, CSA, ATEX, IECEx, GL, LR, DNV, EAC			
Terminal blocks							
		Sold in lots of	Unit reference	Sold in lots of	Unit reference	Sold in lots of	Unit reference
	Green/Yellow	50	NSYTRV23PE	50	NSYTRV24PE	50	NSYTRV43PE
Accessories							
End stop for 35 mm DIN rail	Clip-on, 5.2 mm	50	NSYTRAAB35	50	NSYTRAAB35	50	NSYTRAAB35
	With screw, 9.5 mm	50	NSYTRAABV35	50	NSYTRAABV35	50	NSYTRAABV35
End plate, width 2.2 mm	Grey	50	NSYTRAC23	50	NSYTRAC24	50	NSYTRAC23
	Grey, partial plate	-	-	-	-	-	-
Partition plate, width 2 mm	Grey	50	NSYTRAP23	50	NSYTRAP24	50	NSYTRAP23
	Blue	-	-	-	-	-	-
Plug-in bridge Red	2-pole	50	NSYTRAL22	50	NSYTRAL22	50	NSYTRAL42
	3-pole	50	NSYTRAL23	50	NSYTRAL23	50	NSYTRAL43
	4-pole	50	NSYTRAL24	50	NSYTRAL24	50	NSYTRAL44
	5-pole	50	NSYTRAL25	50	NSYTRAL25	50	NSYTRAL45
	10-pole	10	NSYTRAL210	10	NSYTRAL210	10	NSYTRAL410
	20-pole	10	NSYTRAL220	10	NSYTRAL220	10	NSYTRAL420
Test plug	Metalic part, Ø 2.3 mm	10	NSYTRAATM1	10	NSYTRAATM1	10	NSYTRAATM1
	Insulating sleeve, red	10	NSYTRAATP1	10	NSYTRAATP1	10	NSYTRAATP1
Test adaptor	For plug-in bridge shaft	10	NSYTRAFT	10	NSYTRAFT	10	NSYTRAFT
Warning label	Yellow	10	NSYTRACS2	10	NSYTRACS2	100	NSYTRACS4
Marker tag holder	For ●AB35 end stop	100	NSYTRASB4	100	NSYTRASB4	20	NSYTRASB4
DIN rail 35 x 7.2 mm	Perforated, 2 m long	20	NSYSDR200BD	20	NSYSDR200BD	20	NSYSDR200BD
Marking accessories		See page 142					
General data							
	Strip length (mm)	9		9		9	
	Screw thread	M3		M3		M3	
	Torque (Nm)	0.5 - 0.6		0.5 - 0.6		0.6 - 0.8	

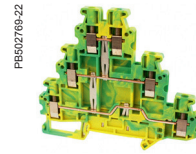
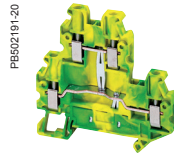
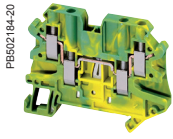

NSYTRV44PE		NSYTRV24DPE		NSYTRV44DPE		NSYTRV26TPE	
4 mm ²		2.5 mm ²		4 mm ²		2,5 mm ²	
Protective earth - Multi-pole		Protective earth - Double deck		Protective earth - Double deck		Protective earth - 3 Levels	
1 pole - 2 x 2		1 pole - 2 x 2		1 pole - 2 x 2		1 pole - 3 x 3	
Green/Yellow		Green/Yellow		Green/Yellow		Green/Yellow	
-		-		-		-	
65.4		69.9		69.9		90	
47.5		65		65		77.5	
6.2		5.2		6.2		5.2	
4		2.5		4		2.5	
0.14 - 6		0.14 - 4		0.14 - 6		0.14 - 4	
0.14 - 6		0.14 - 4		0.14 - 6		0.14 - 4	
-		-		-		-	
26 - 10 AWG		26 - 12 AWG		26 - 10 AWG		26 - 12 AWG	
26 - 10 AWG		26 - 12 AWG		26 - 10 AWG		26 - 12 AWG	
-		-		-		-	
UL, CSA, ATEX, IECEX, GL, LR, DNV, EAC		UL, CSA, ATEX, IECEX, GL, LR, DNV, EAC		UL, CSA, ATEX, IECEX, GL, LR, DNV, EAC		UL, CSA, EAC	
Sold in lots of	Unit reference	Sold in lots of	Unit reference	Sold in lots of	Unit reference	Sold in lots of	Unit reference
50	NSYTRV44PE	50	NSYTRV24DPE	50	NSYTRV44DPE	50	NSYTRV26TPE
50	NSYTRAAB35	50	NSYTRAAB35	50	NSYTRAAB35	50	NSYTRAAB35
50	NSYTRAABV35	50	NSYTRAABV35	50	NSYTRAABV35	50	NSYTRAABV35
50	NSYTRAC24	50	NSYTRACE24	50	NSYTRACE24	50	NSYTRACE26
-	-	50	NSYTRACEP24	50	NSYTRACEP24	-	-
50	NSYTRAP24	50	NSYTRAPE24	50	NSYTRAPE24	-	-
-	-	-	-	-	-	-	-
50	NSYTRAL42	50	NSYTRAL22	50	NSYTRAL42	50	NSYTRAL22
50	NSYTRAL43	50	NSYTRAL23	50	NSYTRAL43	50	NSYTRAL23
50	NSYTRAL44	50	NSYTRAL24	50	NSYTRAL44	50	NSYTRAL24
50	NSYTRAL45	50	NSYTRAL25	50	NSYTRAL45	50	NSYTRAL25
10	NSYTRAL410	10	NSYTRAL210	10	NSYTRAL410	10	NSYTRAL210
10	NSYTRAL420	10	NSYTRAL220	10	NSYTRAL420	10	NSYTRAL220
10	NSYTRAATM1	10	NSYTRAATM1	10	NSYTRAATM1	10	NSYTRAATM1
10	NSYTRAATP1	10	NSYTRAATP1	10	NSYTRAATP1	10	NSYTRAATP1
10	NSYTRAFT	10	NSYTRAFT	10	NSYTRAFT	10	NSYTRAFT
100	NSYTRACS4	100	NSYTRACS2	100	NSYTRACS4	10	NSYTRACS2
20	NSYTRASB4	20	NSYTRASB4	20	NSYTRASB4	100	NSYTRASB4
20	NSYSDR200BD	20	NSYSDR200BD	20	NSYSDR200BD	20	NSYSDR200BD
9		9		9		9	
M3		M3		M3		M3	
0.6 - 0.8		0.5 - 0.6		0.6 - 0.8		0.5 - 0.6	

Screw terminal blocks - Disconnect

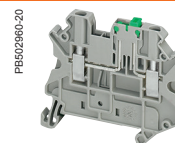

		NSYTRV22SC
Nominal c.s.a.		2.5 mm ²
	Type of block	Disconnect (blade)
	Type of connection	1 pole - 1 x 1
	Color	Grey
Max. electric values (U _{max} , I _{max})		400 V, 20 A
Dimensions (mm)		
	Length	57.8
	Height	49.1
	Width	5.2
Cabling c.s.a. (mm ²)		2.5
	Flexible cable	0.14 - 4
	Solid cable	0.14 - 4
Nominal electric values		
	IEC/EN 60947-7-1	400 V, 20 A
	UL	300 V, 16 A, 26 - 12 AWG
	CSA	300 V, 16 A, 26 - 12 AWG
	ATEX	-
Certifications		UL, CSA, EAC

Terminal blocks		Sold in lots of	Unit reference
	Grey	50	NSYTRV22SC
	Grey, with test points	50	NSYTRV22ST
	Orange, with test points	-	-

Accessories			
1	End stop	Clip-on, 5.2 mm	50 NSYTRAAB35
2	for 35 mm DIN rail	With screw, 9.5 mm	50 NSYTRAABV35
3	End plate, width 2.2 mm	Grey	50 NSYTRAC23
		Grey, partial plate	-
4	Partition plate, width 2 mm	Grey	50 NSYTRAP23
		Blue	-
5	Plug-in bridge	Red	
		2-pole	50 NSYTRAL22
		3-pole	50 NSYTRAL23
		4-pole	50 NSYTRAL24
		5-pole	50 NSYTRAL25
		10-pole	10 NSYTRAL210
	20-pole	10 NSYTRAL220	
	Vertical bridge	1-pole	-
14	Removable carrier width 6.1 mm 6 A max	For fuse 5 x 20 mm	-
		For fuse 5 x 20 mm 110 - 250 V LED	-
		For fuse 5 x 20 mm 12 - 30 V LED	-
15	Removable carrier width 5.1 mm 6 A max	For component	-
		With 1N4007 diode	-
8	Test plug	Metallic part, Ø 2.3 mm	10 NSYTRAATM1
		Insulating sleeve, red	10 NSYTRAATP1
	Test adaptor	For plug-in bridge shaft	10 NSYTRAFT
	Warning label	Yellow	10 NSYTRACS4
	Marker tag holder	For ●AB35 end stop	100 NSYTRASB4
	DIN rail 35 x 7.2 mm	Perforated, 2 m long	20 NSYSDR200BD
	Marking accessories		See page 142

General data	
Strip length (mm)	9
Screw thread	M3
Torque (Nm)	0.5 - 0.6

* Disconnect knife on each level.

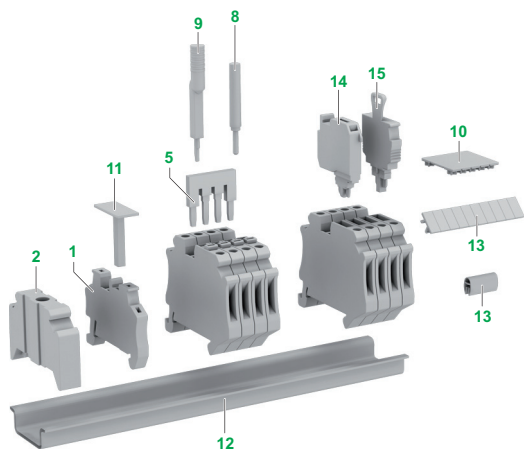

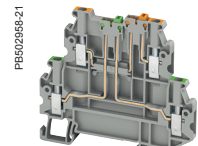
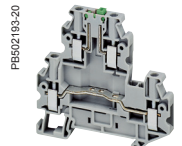
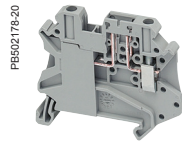
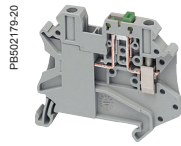
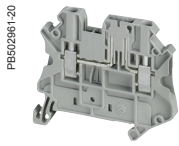

NSYTRV22TB	NSYTRV42SC	NSYTRV42TB	NSYTRV42SCD	NSYTRV24SCD
2.5 mm ²	4 mm ²	4 mm ²	4 mm ²	2.5 mm ²
Disconnect (for carrier)	Disconnect (blade)	Disconnect (for carrier)	Disconnect - Double deck	Disconnect - Double deck
1 pole - 1 x 1	1 pole - 1 x 1	1 pole - 1 x 1	2 pole - 1 x 1	2 pole - 1 x 1
Grey	Grey	Grey	Grey	Grey
400 V, 20 A	500 V, 20 A	400 V, 20 A	500 V, 38 A	500 V, 38 A
57.8	57.8	57.8	69.9	69.9
47.5	49.1	47.5	65	65
5.2	6.2	6.2	6.2	5.2
2.5	4	4	4	2.5
0.14 - 4	0.14 - 6	0.14 - 6	0.14 - 6	0.14 - 4
0.14 - 4	0.14 - 6	0.14 - 6	0.14 - 6	0.14 - 4
400 V, 20 A	500 V, 20 A	500 V, 20 A	500 V, 30 A	500 V, 30 A
600 V, 16 A, 26 - 12 AWG	600 V, 16 A, 26 - 10 AWG	600 V, 16 A, 26 - 10 AWG	300 V, 30 A, 26 - 10 AWG	300 V, 30 A, 26 - 12 AWG
600 V, 16 A, 26 - 12 AWG	600 V, 16 A, 26 - 10 AWG	600 V, 16 A, 26 - 10 AWG	300 V, 30 A, 26 - 10 AWG	-
-	-	-	-	-
UL, CSA, EAC	UL, CSA, EAC	UL, CSA, EAC	UL, CSA, EAC	UL, EAC

Sold in lots of	Unit reference	Sold in lots of	Unit reference	Sold in lots of	Unit reference	Sold in lots of	Unit reference	Sold in lots of	Unit reference
50	NSYTRV22TB	50	NSYTRV42SC	50	NSYTRV42TB	50	NSYTRV42SCD	-	-
-	-	50	NSYTRV42ST	-	-	-	-	50	NSYTRV24SCD*
-	-	50	NSYTRV42STAR	-	-	-	-	-	-

50	NSYTRAAB35	50	NSYTRAAB35	50	NSYTRAAB35	50	NSYTRAAB35	50	NSYTRAAB35
50	NSYTRAABV35	50	NSYTRAABV35	50	NSYTRAABV35	50	NSYTRAABV35	50	NSYTRAABV35
50	NSYTRAC23	-	Included	-	Included	50	NSYTRACE24	50	NSYTRACED24
-	-	-	-	-	-	50	NSYTRACPE24	-	-
50	NSYTRAP23	50	NSYTRAP23	50	NSYTRAP23	50	NSYTRAPE24	-	-
-	-	-	-	-	-	-	-	-	-
50	NSYTRAL22	50	NSYTRAL42	50	NSYTRAL42	50	NSYTRAL42	-	-
50	NSYTRAL23	50	NSYTRAL43	50	NSYTRAL43	50	NSYTRAL43	-	-
50	NSYTRAL24	50	NSYTRAL44	50	NSYTRAL44	50	NSYTRAL44	-	-
50	NSYTRAL25	50	NSYTRAL45	50	NSYTRAL45	50	NSYTRAL45	-	-
10	NSYTRAL210	10	NSYTRAL410	10	NSYTRAL410	10	NSYTRAL410	-	-
10	NSYTRAL220	10	NSYTRAL420	10	NSYTRAL420	10	NSYTRAL420	-	-
-	-	-	-	-	-	-	-	-	-
10	NSYTRASF520	-	-	10	NSYTRASF520	-	-	-	-
10	NSYTRASF520M	-	-	10	NSYTRASF520M	-	-	-	-
10	NSYTRASF520B	-	-	10	NSYTRASF520B	-	-	-	-
10	NSYTRASV1	-	-	10	NSYTRASV1	-	-	-	-
10	NSYTRASV2	-	-	10	NSYTRASV2	-	-	-	-
10	NSYTRAATM1	10	NSYTRAATM1	10	NSYTRAATM1	10	NSYTRAATM1	10	NSYTRAATM1
10	NSYTRAATP1	10	NSYTRAATP1	10	NSYTRAATP1	10	NSYTRAATP1	10	NSYTRAATP1
10	NSYTRAFT	10	NSYTRAFT	10	NSYTRAFT	10	NSYTRAFT	10	NSYTRAFT
10	NSYTRACS4	10	NSYTRACS4	10	NSYTRACS4	10	NSYTRACS4	10	NSYTRACS4
100	NSYTRASB4	100	NSYTRASB4	100	NSYTRASB4	100	NSYTRASB4	100	NSYTRASB4
20	NSYSR200BD	20	NSYSR200BD	20	NSYSR200BD	20	NSYSR200BD	20	NSYSR200BD

9	9	9	9	9
M3	M3	M3	M3	M3
0.5 - 0.6	0.6 - 0.8	0.6 - 0.8	0.6 - 0.8	0.5 - 0.6

Screw terminal blocks - Fuse disconnect

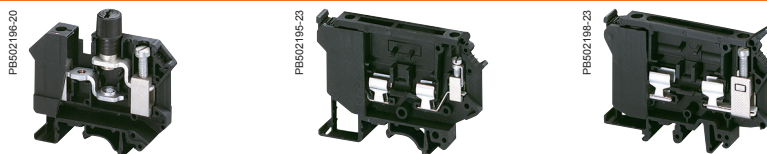

		NSYTRV162SF	NSYTRV42SF5	NSYTRV42SF6			
Nominal c.s.a.		16 mm ²	4 mm ²	16 mm ²			
	Type of block	Disconnect (fixed carrier)	Disconnect (Lever-type fuse)	Disconnect (Lever-type fuse)			
	Type of connection	1 pole - 1 x 1	1 pole - 1 x 1	1 pole - 1 x 1			
	Type of fuse	G-fuse cartridge 5 x 20 mm	G-fuse cartridge 5 x 20 mm	G-fuse cartridge 6.3 x 32 mm			
	Colour	Black	Black	Black			
Max. electric values (U _{max} , I _{max})		500 V, 10 A	500 V, 6.3 A	500 V, 10 A			
Dimensions (mm)							
	Length	62	72.5	79			
	Height	57.2	56.5	60.5			
	Width	12	8.2	10.2			
Cabling c.s.a. (mm ²)		16	4	16			
	Flexible cable	0.5 - 16	0.2 - 4	0.5 - 16			
	Solid cable	0.5 - 16	0.2 - 4	0.5 - 16			
Nominal electric values							
	IEC/EN 60947-7-1	500 V, 10 A	500 V, 6.3 A	500 V, 10 A			
	UL	300 V, 20 A, 24 - 6 AWG	600 V, 12 A, 26 - 10 AWG	600 V, 10 A, 26 - 8 AWG			
	CSA	300 V, 20 A, 24 - 6 AWG	600 V, 12 A, 26 - 10 AWG	600 V, 10 A, 26 - 8 AWG			
	ATEX	-	-	-			
Certifications		UL, CSA, LR, DNV, EAC	UL, CSA, EAC	UL, CSA, EAC			
Terminal blocks							
		Sold in lots of	Unit reference	Sold in lots of	Unit reference	Sold in lots of	Unit reference
	Black	50	NSYTRV162SF	50	NSYTRV42SF5	50	NSYTRV42SF6
	Black, with light indicator, 12-30 V AC/DC (1)	-	-	50	NSYTRV42SF5LD	50	NSYTRV42SF6LD
	Black, with light indicator, 110-250 V AC/DC (2)	-	-	50	NSYTRV42SF5LA	50	NSYTRV42SF6LA
Accessories							
End stop	Clip-on, 5.2 mm	50	NSYTRAAB35	50	NSYTRAAB35	50	NSYTRAAB35
for 35 mm DIN rail	With screw, 9.5 mm	50	NSYTRAABV35	50	NSYTRAABV35	50	NSYTRAABV35
End plate, width 2.2 mm	Grey	-	Included	-	Included	-	Included
	Grey, partial plate	-	-	-	-	-	-
Vertical bridge	1-pole	-	-	-	-	-	-
Screw bridge	2-pole	10	NSYTRALF1610	-	-	-	-
Test plug	Metalic part, Ø 2.3 mm	10	NSYTRAATM1	10	NSYTRAATM1	10	NSYTRAATM1
	Insulating sleeve, red	10	NSYTRAATP1	10	NSYTRAATP1	10	NSYTRAATP1
Test adaptor	For plug-in bridge shaft	-	-	-	-	-	-
Warning label	Yellow	-	-	-	-	-	-
Marker tag holder	For ●AB35 end stop	100	NSYTRASB4	100	NSYTRASB4	100	NSYTRASB4
DIN rail 35 x 7.2 mm	Perforated, 2 m long	20	NSYSDR200BD	20	NSYSDR200BD	20	NSYSDR200BD
Marking accessories		See page 142					
General data							
	Strip length (mm)	11		8		9	
	Screw thread	M4		M3		M3	
	Torque (Nm)	1.5 - 1.8		0.5 - 0.8		0.6 - 0.8	

(1) If the fuse is faulty, the downstream circuit is not off load.

(2) The current is determined by the fuse used, the voltage by the light indicator. Observe max. power dissipation.



Screw terminal blocks - Measuring terminals

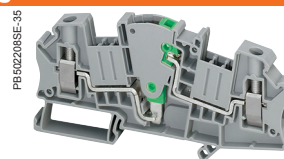

		NSYTRV62TTD		
Nominal c.s.a.	Type of block	Knife disconnect		
	Type of connection	1 pole - 1 x 1		
	Colour	Grey		
	Max. electric values (U _{max} , I _{max})	500 V, 30 A		
Dimensions (mm)				
	Length	100.8		
	Height	49.6		
	Width	8.2		
Cabling c.s.a. (mm ²)		6		
	Flexible cable	0.2 - 10		
	Solid cable	0.2 - 10		
Nominal electric values				
	IEC/EN 60947-7-1	500 V, 30 A		
	UL	600 V, 30 A. 24 - 8 AWG		
	CSA	600 V, 30 A. 24 - 8 AWG		
	ATEX	-		
Certifications		UL, CSA, EAC		
Terminal blocks				
		Sold in lots of	Unit reference	
	Grey	50	NSYTRV62TTD	
	Green/Yellow	-	-	
Accessories				
1	End stop	Clip-on, 5.2 mm	50	NSYTRAAB35
2	for 35 mm DIN rail	With screw, 9.5 mm	50	NSYTRAABV35
3	End plate, width 2.2 mm	Grey	50	NSYTRACT22
		Blue	-	-
14	Switching jumper, pluggable	2 points	10	NSYTRASJ2
		3 points	10	NSYTRASJ3
		4 points	10	NSYTRASJ4
		5-pole	10	NSYTRAL65
5	Plug-in bridge	2-pole	10	NSYTRAL62
		3-pole	10	NSYTRAL63
		4-pole	-	-
		5-pole	10	NSYTRAL65
		10-pole	10	NSYTRAL610
		15	Switching lock	Pluggable
8	Test plug	Metallic part, Ø 2.3 mm	10	NSYTRAATM1
		Insulating sleeve, red	10	NSYTRAATP1
9	Test plug adaptor For plug-in bridge shaft	Grey	10	NSYTRAFT
		Orange	10	NSYTRAFTAR
		Yellow	10	NSYTRAFTYE
		Green	10	NSYTRAFTGN
11	Marker tag holder	For ●AB35 end stop	100	NSYTRASB4
12	DIN rail 35 x 7.2 mm	Perforated, 2 m long	20	NSYSDR200BD
13	Marking accessories		See page 142	
General data				
	Strip length (mm)	10		
	Screw thread	M4		
	Torque (Nm)	1.5 - 1.8		

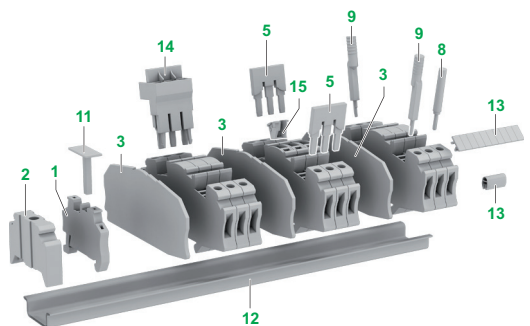

PB50208SE-35

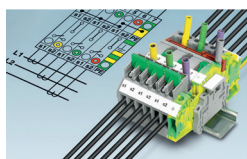

Only two NSYTRV62TTD measuring transducer disconnect terminal blocks are required for a current transformer measuring circuit. This means that less space is required compared to a circuit design using slide-type terminal blocks.

PB50208SE-32

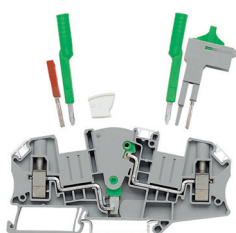

The new NSYTRV62TT measuring transducer disconnect terminal blocks with screw connection technology are characterised by easy operation and clarity. All switching statuses are instantly clearly visible. Due to the extensive range of flexible accessories, costs and time are saved when executing all transducer test circuit tasks.

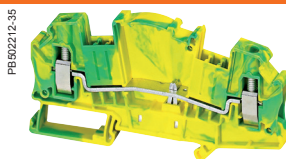
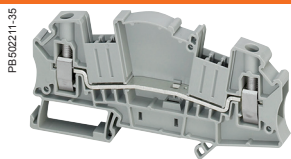

NSYTRV62TT		NSYTRV62TTPE	
6 mm ²		6 mm ²	
Passthrough		Protective earth	
1 pole - 1 x 1		1 pole - 1 x 1	
Grey		Green/Yellow	
500 V, 30 A		-	
100.8		100.8	
49.6		49.6	
8.2		8.2	
6		6	
0.2 - 10		0.2 - 10	
0.2 - 10		0.2 - 10	
500 V, 30 A		-	
600 V, 30 A, 24 - 8 AWG		24 - 8 AWG	
600 V, 30 A, 24 - 8 AWG		24 - 8 AWG	
-		-	
UL, CSA, EAC		UL, CSA, EAC	
Sold in lots of	Unit reference	Sold in lots of	Unit reference
50	NSYTRV62TT	-	-
-	-	50	NSYTRV62TTPE
50	NSYTRAAB35	50	NSYTRAAB35
50	NSYTRAABV35	50	NSYTRAABV35
50	NSYTRACT22	50	NSYTRACT22
-	-	-	-
10	NSYTRASJ2	-	-
10	NSYTRASJ3	-	-
10	NSYTRASJ4	-	-
10	NSYTRAL62	10	NSYTRAL62
10	NSYTRAL63	10	NSYTRAL63
-	-	-	-
10	NSYTRAL65	10	NSYTRAL65
10	NSYTRAL610	10	NSYTRAL610
10	NSYTRASJ6	-	-
10	NSYTRAATM1	10	NSYTRAATM1
10	NSYTRAATP1	10	NSYTRAATP1
10	NSYTRAFT	10	NSYTRAFT
10	NSYTRAFTAR	10	NSYTRAFTAR
10	NSYTRAFTYE	10	NSYTRAFTYE
10	NSYTRAFTGN	10	NSYTRAFTGN
100	NSYTRASB4	100	NSYTRASB4
20	NSYSDR200BD	20	NSYSDR200BD
10		10	
M4		M4	
1.5 - 1.8		1.5 - 1.8	

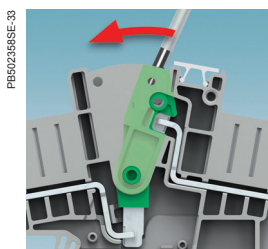

The longitudinal isolating switch contacts snap safely into their respective switching state. Imprinted switching symbols ensure clarity. The optional switching lock snaps in and effectively prevents accidental switching. For simultaneous actuation, two switches can be connected to each other using a connection bridge.

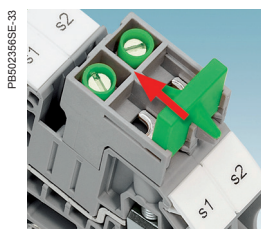

The NSYTRASJ switch jumpers can be placed on both sides of the disconnect point in the bridge shaft and can be securely snapped in irrespective of the terminal strip configuration. The bridge for the transformer short-circuit can be securely engaged in the end positions and screw terminal points are used to make contact.

Screw terminal blocks - Neutral disconnect

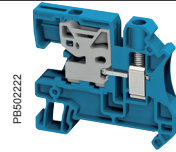
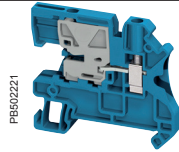

		NSYTRV42NE	NSYTRV62NE		
Nominal c.s.a.	Type of block	4 (6) mm ² Neutral disconnect	6 (10) mm ² Neutral disconnect		
	Type of connection	1 pole - 1 x 1	1 pole - 1 x 1		
	Colour	Blue	Blue		
	Max. electric values (U _{max} , I _{max})	250 V, 32 A	400 V, 41 A		
Dimensions (mm)					
	Length	55	55		
	Height	47,5	47,5		
	Width	6,2	8,2		
Cabling c.s.a. (mm ²)		4	6		
	Flexible cable	0.14 - 6	0.2 - 10		
	Solid cable	0.14 - 6	0.2 - 10		
Nominal electric values					
	IEC/EN 60947-7-1	250 V, 32 A	400 V, 41 A		
	UL	-	-		
	CSA	-	-		
	ATEX	-	-		
Certifications		EAC	EAC		
Terminal blocks					
	Blue	Sold in lots of 50 Unit reference NSYTRV42NE	Sold in lots of 50 Unit reference NSYTRV62NE		
Accessories					
End stop for 35 mm DIN rail	Clip-on, 5.2 mm	50	NSYTRAAB35	50	NSYTRAAB35
	With screw, 9.5 mm	50	NSYTRAABV35	50	NSYTRAABV35
End plate, width 2.2 mm	Grey	50	NSYTRAC22	50	NSYTRAC22
	Blue	50	NSYTRAC22BL	50	NSYTRAC22BL
Partition plate, width 2 mm	Grey	50	NSYTRAP22	50	NSYTRAP22
	Blue	50	NSYTRAP22BL	50	NSYTRAP22BL
Plug-in bridge Red	2-pole	50	NSYTRAL42	10	NSYTRAL62
	3-pole	50	NSYTRAL43	10	NSYTRAL63
	4-pole	50	NSYTRAL44	-	-
	5-pole	50	NSYTRAL45	50	NSYTRAL65
	10-pole	10	NSYTRAL410	10	NSYTRAL610
	20-pole	10	NSYTRAL420	-	-
	Blue	10-pole	10	NSYTRAL410BL	-
Grey	10-pole	10	NSYTRAL410GR	-	-
Copper neutral bar	1m long, 10 x 3 mm	10	NSYTRACB103	10	NSYTRACB103
Terminal clamp for neutral bar		25	NSYBPCH516	25	NSYBPCH516
Test plug	Metallic part, Ø 2.3 mm	10	NSYTRAATM1	10	NSYTRAATM1
	Insulating sleeve, red	10	NSYTRAATP1	10	NSYTRAATP1
Test adaptor	For plug-in bridge shaft	10	NSYTRAFT	10	NSYTRAFT
Marker tag holder	For ●AB35 end stop	100	NSYTRASB4	100	NSYTRASB4
DIN rail 35 x 7.2 mm	Perforated, 2 m long	20	NSYSDR200BD	20	NSYSDR200BD
Marking accessories		See page 142			
General data					
	Strip length (mm)	9	10		
	Screw thread	M3	M4		
	Torque (Nm)	0.6 - 0.8	1.5 - 1.8		

FB602357-33

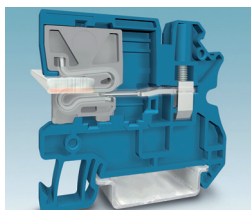

All **NSYTRV●●NE** disconnect terminal blocks have a screwless disconnect slide. When this is levered over with a standard screwdriver, the contact fork slides onto the busbar. The slide engages in the end positions to provide additional protection against accidental actuation. The shape of the **NSYTRV●●NE** disconnect terminal blocks is the same as for the screw terminal blocks **NSYTRV**.

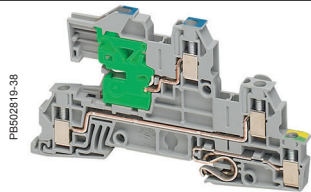
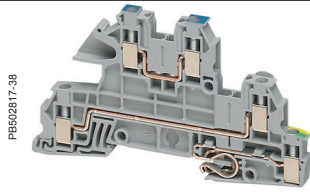
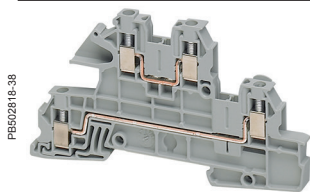

NSYTRV25LL		NSYTRV25LLPE		NSYTRV25NLPE	
2,5 mm ²		2,5 mm ²		2,5 mm ²	
Installation - 2 phases		Installation - 2 phases + protective earth		Installation - 1 phase + protective earth + neutral disconnect	
2 pole - 1 x 1		3 pole - 1 x 1		3 pole - 1 x 1	
Grey		Grey		Grey	
250 V, 30 A		250 V, 30 A		LL 400V, 250 V, 30 A	
93.5		93.5		93.5	
51.5		51.5		51.5	
5.2		5.2		5.2	
2.5		2.5		2.5	
0.2 - 4		0.2 - 4		0.2 - 4	
0.2 - 4		0.2 - 4		0.2 - 4	
250 V, 24 A		250 V, 24 A		LL 400V, 250 V, 24 A	
300 V, 20 A, 26 - 12 AWG		300 V, 20 A, 26 - 12 AWG		300 V, 20 A, 26 - 12 AWG	
300 V, 20 A, 26 - 12 AWG		300 V, 20 A, 26 - 12 AWG		300 V, 20 A, 26 - 12 AWG	
-		-		-	
UL, CSA, EAC		UL, CSA, EAC		UL, CSA, EAC	
Sold in lots of	Unit reference	Sold in lots of	Unit reference	Sold in lots of	Unit reference
50	NSYTRV25LL	50	NSYTRV25LLPE	50	NSYTRV25NLPE
50	NSYTRAAB35	50	NSYTRAAB35	50	NSYTRAAB35
50	NSYTRAABV35	50	NSYTRAABV35	50	NSYTRAABV35
50	NSYTRAC25	50	NSYTRAC25	50	NSYTRAC25
	-		-		-
	-		-		-
	-		-		-
50	NSYTRAL22	50	NSYTRAL22	50	NSYTRAL22
50	NSYTRAL23	50	NSYTRAL23	50	NSYTRAL23
50	NSYTRAL24	50	NSYTRAL24	50	NSYTRAL24
50	NSYTRAL25	50	NSYTRAL25	50	NSYTRAL25
10	NSYTRAL210	10	NSYTRAL210	10	NSYTRAL210
10	NSYTRAL220	10	NSYTRAL220	10	NSYTRAL220
10	NSYTRAL210BL	10	NSYTRAL210BL	10	NSYTRAL210BL
10	NSYTRAL210GR	10	NSYTRAL210GR	10	NSYTRAL210GR
	-		-	10	NSYTRACB103
	-		-	25	NSYBPCH516
10	NSYTRAATM1	10	NSYTRAATM1	10	NSYTRAATM1
10	NSYTRAATP1	10	NSYTRAATP1	10	NSYTRAATP1
10	NSYTRAFT	10	NSYTRAFT	10	NSYTRAFT
100	NSYTRASB4	100	NSYTRASB4	100	NSYTRASB4
20	NSYS DR200BD	20	NSYS DR200BD	20	NSYS DR200BD
9		9		9	
M3		M3		M3	
0.5 - 0.6		0.5 - 0.6		0.5 - 0.6	

Screw terminal blocks - Miniature passthrough

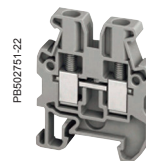

		NSYTRV22M			
Nominal c.s.a.		2.5 mm ²			
	Type of block	Passthrough			
	Type of connection	1 pole - 1 x 1			
	Colour	Grey			
Max. electric values (U _{max} , I _{max})		500 V, 24 A			
Dimensions (mm)					
	Length	30			
	Height	34			
	Width	5.2			
Mounting on		NS15 DIN rail			
Cabling c.s.a. (mm ²)		2.5			
	Flexible cable	0.2 - 2.5			
	Solid cable	0.2 - 4			
Nominal electric values					
	IEC/EN 60947-7-1	500 V, 24 A			
	UL	600 V, 20 A, 24 - 12 AWG			
	CSA	600 V, 20 A, 24 - 12 AWG			
	ATEX	500 V, 20 A			
Certifications		UL, CSA, VDE, ATEX, IECEx, EAC			
Terminal blocks					
	Grey	Sold in lots of 50	Unit reference NSYTRV22M		
	Blue	50	NSYTRV22MBL		
Accessories					
1	End stop for 15 mm DIN rail	Clip-on, 5.2 mm	50	NSYTRAAB15	
3	End plate	Grey	50	NSYTRACM22	
4	Partition plate	Grey	50	NSYTRAPM22	
5	Plug-in bridge	Red	2-pole	50	NSYTRAL22
			3-pole	50	NSYTRAL23
			4-pole	50	NSYTRAL24
			5-pole	50	NSYTRAL25
			10-pole	10	NSYTRAL210
			20-pole	10	NSYTRAL220
			Blue	10-pole	10
	Grey	10-pole	10	NSYTRAL210GR	
11	Marker tag holder	For AB15 end stop	100	NSYTRASB4	
12	DIN rail 15 x 5mm	Perforated, 2m long	10	NSYTRADR155	
13	Marking accessories		See page 142		
General data					
	Strip length (mm)		9		
	Screw thread		M3		
	Torque (Nm)		0.5 - 0.6		

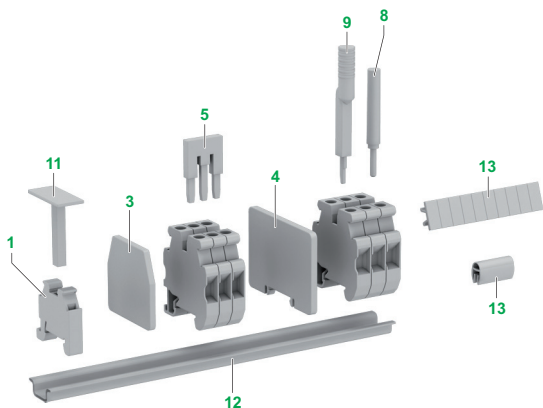

Screw terminal blocks - Miniature protective earth

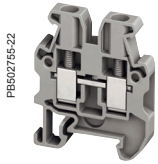

NSYTRV42M
4 mm²
Passthrough
1 pole - 1 x 1
Grey
500 V, 32 A

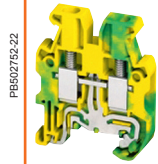

NSYTRV22MPE
2.5 mm²
Protective earth
1 pole - 1 x 1
Green/Yellow
-

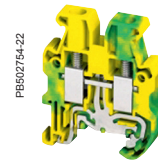

NSYTRV42MPE
4 mm²
Protective earth
1 pole - 1 x 1
Green/Yellow
-

30
34
6.2
NS15 DIN rail
4
0.2 - 4
0.2 - 6

30
34
5.2
NS15 DIN rail
2.5
0.2 - 2.5
0.2 - 4

30
34
6.2
NS15 DIN rail
4
0.2 - 4
0.2 - 6

500 V, 32 A
600 V, 30 A, 24 - 10 AWG
600 V, 30 A, 24 - 10 AWG
500 V, 30 A
UL, CSA, VDE, ATEX, IECEx, EAC

-
24 - 12 AWG
24 - 12 AWG
-
UL, CSA, VDE, ATEX, IECEx, EAC

-
24 - 10 AWG
24 - 10 AWG
-
UL, CSA, VDE, ATEX, IECEx, EAC

Sold in lots of	Unit reference
50	NSYTRV42M
50	NSYTRV42MBL

Sold in lots of	Unit reference
50	NSYTRV22MPE
-	-

Sold in lots of	Unit reference
50	NSYTRV42MPE
-	-

50	NSYTRAAB15
50	NSYTRACM22
50	NSYTRAPM22
50	NSYTRAL42
50	NSYTRAL43
50	NSYTRAL44
50	NSYTRAL45
10	NSYTRAL410
10	NSYTRAL420
10	NSYTRAL410BL
10	NSYTRAL410GR
100	NSYTRASB4
10	NSYTRADR155





50	NSYTRAAB15
50	NSYTRACM22
50	NSYTRAPM22
-	-
-	-
-	-
-	-
-	-
-	-
-	-
-	-
-	-
100	NSYTRASB4
10	NSYTRADR155

50	NSYTRAAB15
50	NSYTRACM22
50	NSYTRAPM22
-	-
-	-
-	-
-	-
-	-
-	-
-	-
-	-
-	-
100	NSYTRASB4
10	NSYTRADR155

8
M3
0.6 - 0.8

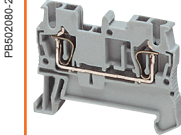
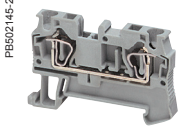
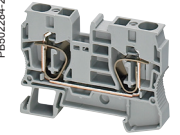
9
M3
0.5 - 0.6

8
M3
0.6 - 0.8

		Passthrough			
		Passthrough			
					
Nominal c.s.a (mm²)		2.5	4	6	10, 16 & 35
Number of poles	1 - 1 x 1	NSYTRR22	NSYTRR42	NSYTRR62	NSYTRR102 NSYTRR162 NSYTRR352
	1 - 1 x 2	NSYTRR23	NSYTRR43	NSYTRR63	-
	1 - 2 x 2	NSYTRR24	NSYTRR44	-	-
	1 - 2 x 4	-	-	-	-
	1 - 3 x 3	-	-	-	-
	2 - 1 x 1	-	-	-	-
	2 - 1 x 2	-	-	-	-
	3 - 1 x 1	-	-	-	-
Colours	Grey	■	■	■	■
	Blue	NSYTRR22BL NSYTRR23BL NSYTRR24BL	NSYTRR42BL NSYTRR43BL NSYTRR44BL	NSYTRR62BL	NSYTRR102BL NSYTRR162BL NSYTRR352BL
	Green/yellow (PE)	-	-	-	-
	Orange	NSYTRR22AR NSYTRR23AR NSYTRR24AR	NSYTRR42AR NSYTRR43AR NSYTRR44AR	-	-
	Black	-	-	-	-
	With flange	-	-	-	-
Mounting on	35 mm 	■	■	■	■
	35 mm 	■	■	■	■
	Telequick	-	-	-	-
	15 mm 	-	-	-	-
See pages	106/107	107/108	108/109	109	



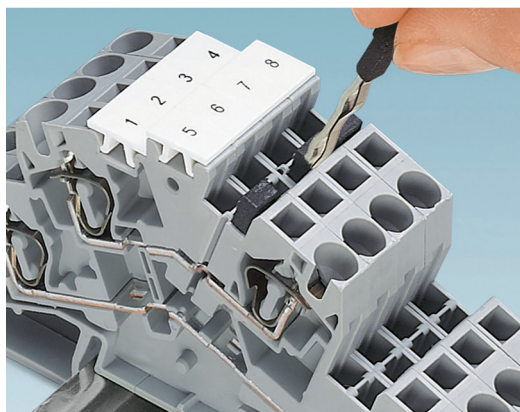

PBE02354-70

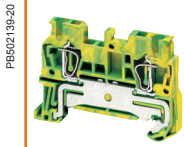
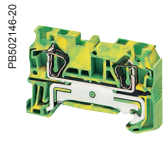
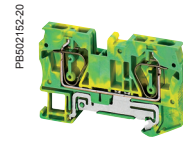
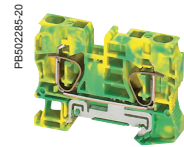

Vertical bridge

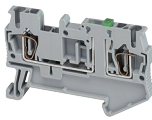
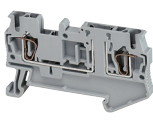
The NSYTRALV24R vertical bridge offers the option of connecting both levels of the standard double-level NSYTRR24D and NSYTRR44D terminal blocks.

Protective earth				
 PB602138-20	 PB602146-20	 PB602152-20	 PB602285-20	
2.5	4	6	10, 16 & 35	
NSYTRR22PE	NSYTRR42PE	NSYTRR62PE	NSYTRR102PE NSYTRR162PE NSYTRR352PE	
NSYTRR23PE	NSYTRR43PE	-	-	
NSYTRR24PE	NSYTRR44PE	-	-	
-	-	-	-	
-	-	-	-	
-	-	-	-	
-	-	-	-	
-	-	-	-	
-	-	-	-	
■	■	■	■	
-	-	-	-	
-	-	-	-	
■	■	■	■	
■	■	■	■	
-	-	-	-	
-	-	-	-	
110	111	111	112	

		Double deck		Disconnect	
		Passthrough		Blade	
		Removable carrier			
					
Nominal c.s.a (mm ²)		2.5 & 4		2.5 & 4	
Number of poles	1 - 1 x 1	-	NSYTRR22SC NSYTRR42SC	NSYTRR22TB NSYTRR42TB	
	1 - 1 x 2	-	NSYTRR23SC	NSYTRR23TB	
	1 - 2 x 2	-	-	-	
	1 - 2 x 4	-	-	-	
	1 - 3 x 3	NSYTRR26TC	-	-	
	2 - 1 x 1	NSYTRR24D NSYTRR44D	NSYTRR24SCD	-	
	2 - 1 x 2	-	-	-	
	3 - 1 x 1	NSYTRR26T	-	-	
Colours	Grey	■	■	■	
	Blue	NSYTRR24DBL NSYTRR44DBL NSYTRR26TBL	-	-	
	Green/yellow (PE)	NSYTRR24DPE NSYTRR44DPE NSYTRR26TPE	-	-	
	Orange	-	NSYTRR22SCAR NSYTRR42SCAR NSYTRR23SCAR	-	
	Black	-	-	-	
	With flange	-	-	-	
Mounting on	35 mm 	■	■	■	
	35 mm 	■	■	■	
	Telequick	-	-	-	
	15 mm 	-	-	-	
See pages	114/115/116	118/119/120	119/120		

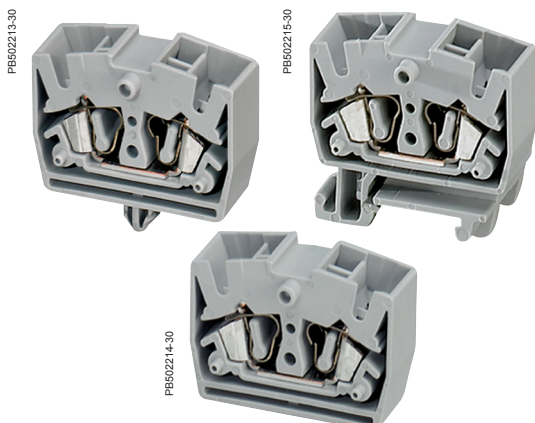

Miniature terminal blocks with maximum usage

Due to its space saving design, mini spring-cage terminal blocks are ideal for wiring in extremely restricted spaces. The generous connection space enables fast wiring of both stranded and solid conductors. They can be mounted on NS 15 DIN rail or directly mounted using screw flange or engagement pins.

Miniature			
	DIN rail mounting	Direct mounting	Pin mounting
PB 802216-20		PB 802216-20	PB 802217-20
	2.5	2.5	2.5
	NSYTRR22M	NSYTRR22MF	NSYTRR22MP
	-	-	-
	NSYTRR24M	NSYTRR24MF	NSYTRR24MP
	-	-	-
	-	-	-
	-	-	-
	-	-	-
	■	■	■
	NSYTRR22MBL NSYTRR24MBL	NSYTRR22MFBL NSYTRR24MFBL	NSYTRR22MPBL NSYTRR24MPBL
	NSYTRR22MPE	-	-
	-	-	-
	-	-	-
	-	NSYTRR22MFF NSYTRR24MFF	-
	-	-	-
	-	-	-
	-	-	-
	■	-	-
	122/123	124/125	125

Spring terminal blocks - Passthrough

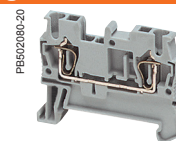

		NSYTRR22			
Nominal c.s.a.		2.5 mm ²			
	Type of block	Passthrough			
	Type of connection	1 pole - 1 x 1			
	Colour	Grey			
Max. electric values (U _{max} , I _{max})		800 V, 31 A			
Dimensions (mm)					
	Length	48.5			
	Height	36.5			
	Width	5.2			
Cabling c.s.a. (mm ²)		2.5			
	Flexible cable	0.08 - 2.5			
	Solid cable	0.08 - 4			
Nominal electric values					
	IEC/EN 60947-7-1	800 V, 24 A			
	UL	600 V, 20 A, 28 - 12 AWG			
	CSA	600 V, 20 A, 28 - 12 AWG			
	ATEX	550 V, 21 A			
Certifications		UL, CSA, VDE, ATEX, IECEx, GL, LR, DNV, EAC			
Terminal blocks					
		Sold in lots of	Unit reference		
	Grey	50	NSYTRR22		
	Blue	50	NSYTRR22BL		
	Orange	50	NSYTRR22AR		
Accessories					
1	End stop	Clip-on, 5.2 mm	50	NSYTRAAB35	
2	for 35 mm DIN rail	With screw, 9.5 mm	50	NSYTRAABV35	
3	End plate, width 2.2 mm	Grey	50	NSYTRACR22	
		Blue	50	NSYTRACR22BL	
4	Partition plate, width 2 mm	Grey	50	NSYTRAPR42	
		Blue	-	-	
5	Plug-in bridge	Red	2-pole	50	NSYTRAL22
		3-pole	50	NSYTRAL23	
		4-pole	50	NSYTRAL24	
		5-pole	50	NSYTRAL25	
		10-pole	10	NSYTRAL210	
		20-pole	10	NSYTRAL220	
		Blue	10-pole	10	NSYTRAL210BL
Grey	10-pole	10	NSYTRAL210GR		
6	Step-down bridge, down to 2.5/4 mm ²	Screw to screw terminal	-	-	
		Spring to spring terminal	-	-	
8	Test plug	Metallic part, Ø 2.3 mm	10	NSYTRAATM1	
		Insulating sleeve, red	10	NSYTRAATP1	
9	Test adaptor	For plug-in bridge shaft	10	NSYTRAFT	
10	Warning label	Yellow	10	NSYTRACSR2	
11	Marker tag holder	For ●AB35 end stop	100	NSYTRASB4	
12	DIN rail 35 x 7.2 mm	Perforated, 2 m long	20	NSYSDR200BD	
13	Marking accessories		See page 142		
General data					
	Strip length (mm)		10		

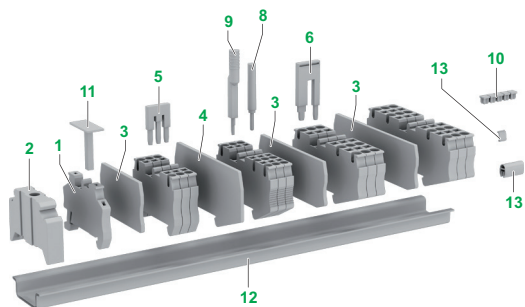

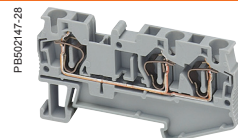
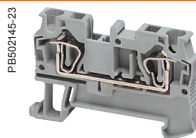
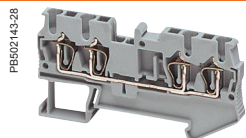
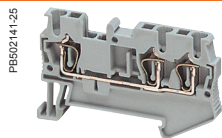

NSYTRR23	NSYTRR24	NSYTRR42	NSYTRR43
2.5 mm ²	2.5 mm ²	4 mm ²	4 mm ²
Passthrough	Passthrough	Passthrough	Passthrough
1 pole - 1 x 2	1 pole - 2 x 2	1 pole - 1 x 1	1 pole - 1 x 2
Grey	Grey	Grey	Grey
800 V, 28 A	800 V, 28 A	800 V, 40 A	800 V, 40 A

60.5	72	56	71.5
36.5	36.5	36.5	36.5
5.2	5.2	6.2	6.2
2.5	2.5	4	4
0.08 - 2.5	0.08 - 2.5	0.08 - 4	0.08 - 4
0.08 - 4	0.08 - 4	0.08 - 6	0.08 - 6

800 V, 24 A	800 V, 24 A	800 V, 32 A	800 V, 32 A
600 V, 20 A, 28 - 12 AWG	600 V, 20 A, 28 - 12 AWG	600 V, 30 A, 28 - 10 AWG	600 V, 30 A, 28 - 10 AWG
600 V, 20 A, 28 - 12 AWG	600 V, 20 A, 28 - 12 AWG	600 V, 30 A, 28 - 10 AWG	600 V, 30 A, 28 - 10 AWG
550 V, 21 A	550 V, 21 A	550 V, 30 A	550 V, 30 A
UL, CSA, VDE, ATEX, IECEX, GL, LR, DNV, EAC	UL, CSA, VDE, ATEX, IECEX, GL, LR, DNV, EAC	UL, CSA, VDE, ATEX, IECEX, GL, LR, DNV, EAC	UL, CSA, VDE, ATEX, IECEX, GL, LR, DNV, EAC

Sold in lots of	Unit reference	Sold in lots of	Unit reference	Sold in lots of	Unit reference	Sold in lots of	Unit reference
50	NSYTRR23	50	NSYTRR24	50	NSYTRR42	50	NSYTRR43
50	NSYTRR23BL	50	NSYTRR24BL	50	NSYTRR42BL	50	NSYTRR43BL
50	NSYTRR23AR	50	NSYTRR24AR	50	NSYTRR42AR	50	NSYTRR43AR

50	NSYTRAAB35	50	NSYTRAAB35	50	NSYTRAAB35	50	NSYTRAAB35
50	NSYTRAABV35	50	NSYTRAABV35	50	NSYTRAABV35	50	NSYTRAABV35
50	NSYTRACR23	50	NSYTRACR24	50	NSYTRACR42	50	NSYTRACR43
50	NSYTRACR23BL	50	NSYTRACR24BL	-	-	-	-
50	NSYTRAPR23	50	NSYTRAPR24	50	NSYTRAPR42	-	-
-	-	-	-	-	-	-	-
50	NSYTRAL22	50	NSYTRAL22	50	NSYTRAL42	50	NSYTRAL42
50	NSYTRAL23	50	NSYTRAL23	50	NSYTRAL43	50	NSYTRAL43
50	NSYTRAL24	50	NSYTRAL24	50	NSYTRAL44	50	NSYTRAL44
50	NSYTRAL25	50	NSYTRAL25	50	NSYTRAL45	50	NSYTRAL45
10	NSYTRAL210	10	NSYTRAL210	10	NSYTRAL410	10	NSYTRAL410
10	NSYTRAL220	10	NSYTRAL220	10	NSYTRAL420	10	NSYTRAL420
10	NSYTRAL210BL	10	NSYTRAL210BL	10	NSYTRAL410BL	10	NSYTRAL410BL
10	NSYTRAL210GR	10	NSYTRAL210GR	10	NSYTRAL410GR	10	NSYTRAL410GR
-	-	-	-	-	-	-	-
-	-	-	-	-	-	-	-
10	NSYTRAATM1	10	NSYTRAATM1	10	NSYTRAATM1	10	NSYTRAATM1
10	NSYTRAATP1	10	NSYTRAATP1	10	NSYTRAATP1	10	NSYTRAATP1
10	NSYTRAFT	10	NSYTRAFT	10	NSYTRAFT	10	NSYTRAFT
10	NSYTRACSR2	10	NSYTRACSR2	10	NSYTRACSR4	10	NSYTRACSR4
100	NSYTRASB4	100	NSYTRASB4	100	NSYTRASB4	100	NSYTRASB4
20	NSYSR200BD	20	NSYSR200BD	20	NSYSR200BD	20	NSYSR200BD

10	10	10	10
----	----	----	----

Spring terminal blocks - Passthrough

PB602148-33

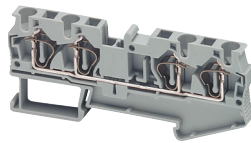

PB602151-28

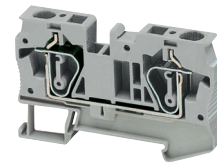

	NSYTTR44	NSYTTR62
Nominal c.s.a.	4 mm ²	6 mm ²
Type of block	Passthrough	Passthrough
Type of connection	1 pole - 2 x 2	1 pole - 1 x 1
Colour	Grey	Grey
Max. electric values (U _{max} , I _{max})	800 V, 40 A	1000 V, 52 A

Dimensions (mm)		
Length	87	69.5
Height	36.5	43.5
Width	6.2	8.2
Cablings c.s.a. (mm ²)	4	6
Flexible cable	0.08 - 4	0.5 - 6
Solid cable	0.08 - 6	0.2 - 10

Nominal electric values		
IEC/EN 60947-7-1	800 V, 32 A	800 V, 41 A
UL	600 V, 30 A, 28 -10 AWG	600 V, 50 A, 24 - 8 AWG
CSA	600 V, 30 A, 28 -10 AWG	600 V, 50 A, 24 - 8 AWG
ATEX	550 V, 30 A	550 V, 36 A
Certifications	UL, CSA, VDE, ATEX, IECEx, GL, LR, DNV, EAC	UL, CSA, VDE, ATEX, IECEx, GL, LR, DNV, EAC

Terminal blocks					
		Sold in lots of	Unit reference	Sold in lots of	Unit reference
	Grey	50	NSYTTR44	50	NSYTTR62
	Blue	50	NSYTTR44BL	50	NSYTTR62BL
	Orange	50	NSYTTR44AR	-	-

Accessories					
End stop	Clip-on, 5.2 mm	50	NSYTRAAB35	50	NSYTRAAB35
for 35 mm DIN rail	With screw, 9.5 mm	50	NSYTRAABV35	50	NSYTRAABV35
End plate, width 2.2 mm	Grey	50	NSYTRACR44	50	NSYTRACR62
	Blue	-	-	-	-
Partition plate, width 2 mm	Grey	-	-	-	-
	Blue	-	-	-	-
Plug-in bridge	2-pole	50	NSYTRAL42	10	NSYTRAL62
	3-pole	50	NSYTRAL43	10	NSYTRAL63
	4-pole	50	NSYTRAL44	-	-
	5-pole	50	NSYTRAL45	10	NSYTRAL65
	10-pole	10	NSYTRAL410	10	NSYTRAL610
	20-pole	10	NSYTRAL420	-	-
Blue	10-pole	10	NSYTRAL410BL	10	NSYTRAL610BL
Grey	10-pole	10	NSYTRAL410GR	10	NSYTRAL610GR
Step-down bridge, down to 2.5/4 mm ²	Screw to screw terminal	-	-	-	-
	Spring to spring terminal	-	-	10	NSYTRALR62
Test plug	Metallic part, Ø 2.3 mm	10	NSYTRAATM1	10	NSYTRAATM1
	Insulating sleeve, red	10	NSYTRAATP1	10	NSYTRAATP1
Test adaptor	For plug-in bridge shaft	10	NSYTRAFT	10	NSYTRAFT
Warning label	Yellow	10	NSYTRACSR4	10	NSYTRACSR6
Marker tag holder	For ●AB35 end stop	100	NSYTRASB4	100	NSYTRASB4
DIN rail 35 x 7.2 mm	Perforated, 2 m long	20	NSYSR200BD	20	NSYSR200BD

Marking accessories See page 142

General data		
Strip length (mm)	10	12

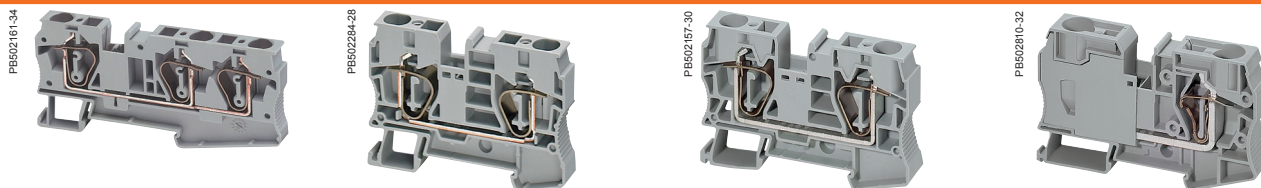

NSYTTR63	NSYTTR102	NSYTTR162	NSYTTR352
6 mm ²	10 mm ²	16 mm ²	35 mm ²
Passthrough	Passthrough	Passthrough	Passthrough
1 pole - 1 x 2	1 pole - 1 x 1	1 pole - 1 x 1	1 pole - 1 x 1
Grey	Grey	Grey	Grey
1000 V, 52 A	1000 V, 65 A	1000 V, 90 A	1000 V, 125 A

90.5	71.5	80	100
43.5	50.5	51	59
8.2	10.2	12.2	16
6	10	16	35
0.5 - 6	0.2 - 10	0.2 - 16	2.5 - 35
0.2 - 10	0.2 - 16	0.2 - 25	2.5 - 35

800 V, 41 A	800 V, 57 A	800 V, 76 A	1000 V, 125 A
600 V, 50 A, 24 - 8 AWG	600 V, 65 A, 16 - 6 AWG	600 V, 85 A, 16 - 4 AWG	600 V, 115 A, 14 - 2 AWG
600 V, 50 A, 24 - 8 AWG	600 V, 65 A, 16 - 6 AWG	600 V, 85 A, 16 - 4 AWG	600 V, 115 A, 14 - 2 AWG
550 V, 30 A	550 V, 50 A	550 V, 65 A	-
UL, CSA, VDE, ATEX, IECEX, GL, LR, DNV, EAC	UL, CSA, VDE, ATEX, IECEX, GL, LR, DNV, EAC	UL, CSA, VDE, ATEX, IECEX, GL, LR, DNV, EAC	UL, CSA, EAC

Sold in lots of	Unit reference	Sold in lots of	Unit reference	Sold in lots of	Unit reference	Sold in lots of	Unit reference
50	NSYTTR63	50	NSYTTR102	50	NSYTTR162	10	NSYTTR352
-	-	50	NSYTTR102BL	50	NSYTTR162BL	10	NSYTTR352BL
-	-	-	-	-	-	-	-

50	NSYTRAAB35	50	NSYTRAAB35	50	NSYTRAAB35	50	NSYTRAAB35
50	NSYTRAABV35	50	NSYTRAABV35	50	NSYTRAABV35	50	NSYTRAABV35
50	NSYTRACR63	50	NSYTRACR102	50	NSYTRACR162	-	Included
-	-	-	-	-	-	-	-
-	-	-	-	-	-	-	-
-	-	-	-	-	-	-	-
10	NSYTRAL62	10	NSYTRAL102	10	NSYTRAL162	10	NSYTRAL352
10	NSYTRAL63	-	-	-	-	-	-
-	-	-	-	-	-	-	-
10	NSYTRAL65	-	-	-	-	-	-
10	NSYTRAL610	-	-	-	-	-	-
-	-	-	-	-	-	-	-
10	NSYTRAL610BL	-	-	-	-	-	-
10	NSYTRAL610GR	-	-	-	-	-	-
-	-	-	-	-	-	-	-
10	NSYTRALR62	10	NSYTRALR102	10	NSYTRALR162	-	-
10	NSYTRAATM1	10	NSYTRAATM1	-	-	-	-
10	NSYTRAATP1	10	NSYTRAATP1	-	-	-	-
10	NSYTRAFT	10	NSYTRAFT	-	-	-	-
10	NSYTRACSR6	10	NSYTRACSR10	10	NSYTRACSR10	10	NSYTRACSR10
100	NSYTRASB4	100	NSYTRASB4	100	NSYTRASB4	100	NSYTRASB4
20	NSYSDR200BD	20	NSYSDR200BD	20	NSYSDR200BD	20	NSYSDR200BD

12	18	18	25
----	----	----	----

Spring terminal blocks - Protective earth

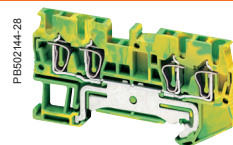
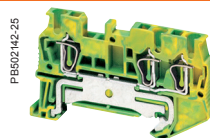
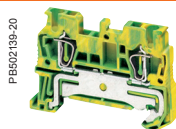

Nominal c.s.a.		NSYTRR22PE	NSYTRR23PE	NSYTRR24PE			
	Type of block	Protective earth	Protective earth	Protective earth			
	Type of connection	1 pole - 1 x 1	1 pole - 1 x 2	1 pole - 2 x 2			
	Colour	Green/Yellow	Green/Yellow	Green/Yellow			
Max. electric values		-	-	-			
Dimensions (mm)							
	Length	48.5	60.5	72			
	Height	36.5	36.5	36.5			
	Width	5.2	5.2	5.2			
Cabling c.s.a. (mm ²)		2.5	2.5	2.5			
	Flexible cable	0.08 - 2.5	0.08 - 2.5	0.08 - 2.5			
	Solid cable	0.08 - 4	0.08 - 4	0.08 - 4			
Nominal electric values							
	IEC/EN 60947-7-1	-	-	-			
	UL	28 - 12 AWG	28 - 12 AWG	28 - 12 AWG			
	CSA	28 - 12 AWG	28 - 12 AWG	28 - 12 AWG			
	ATEX	-	-	-			
Certifications		UL, CSA, VDE, ATEX, IECEx, GL, LR, DNV, EAC	UL, CSA, VDE, ATEX, IECEx, GL, LR, DNV, EAC	UL, CSA, VDE, ATEX, IECEx, GL, LR, DNV, EAC			
Terminal blocks							
		Sold in lots of	Unit reference	Sold in lots of	Unit reference	Sold in lots of	Unit reference
	Green/Yellow	50	NSYTRR22PE	50	NSYTRR23PE	50	NSYTRR24PE
Accessories							
End stop for 35mm DIN rail	Clip-on, 5.2 mm	50	NSYTRAAB35	50	NSYTRAAB35	50	NSYTRAAB35
	With screw, 9.5 mm	50	NSYTRAABV35	50	NSYTRAABV35	50	NSYTRAABV35
End plate, width 2.2 mm	Grey	50	NSYTRACR22	50	NSYTRACR23	50	NSYTRACR24
	Blue	50	NSYTRACR22BL	50	NSYTRACR23BL	50	NSYTRACR24BL
Partition plate, width 2 mm	Grey	50	NSYTRAPR42	50	NSYTRAPR23	50	NSYTRAPR24
	Blue	-	-	-	-	-	-
Plug-in bridge Red	2-pole	-	-	-	-	-	-
	3-pole	-	-	-	-	-	-
	10-pole	-	-	-	-	-	-
Test plug	Metallic part, Ø 2.3 mm	10	NSYTRAATM1	10	NSYTRAATM1	10	NSYTRAATM1
	Insulating sleeve, red	10	NSYTRAATP1	10	NSYTRAATP1	10	NSYTRAATP1
Test adaptor	For plug-in bridge shaft	10	NSYTRAFT	10	NSYTRAFT	10	NSYTRAFT
Warning label	Yellow	10	NSYTRACSR2	10	NSYTRACSR2	10	NSYTRACSR2
Marker tag holder	For ●AB35 end stop	100	NSYTRASB4	100	NSYTRASB4	100	NSYTRASB4
DIN rail 35 x 7.2 mm	Perforated, 2 m long	20	NSYSDR200BD	20	NSYSDR200BD	20	NSYSDR200BD
Marking accessories		See page 142					
General data							
	Strip length (mm)	10		10		10	

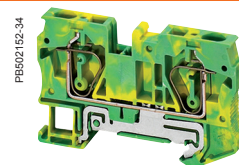
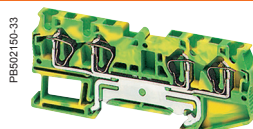
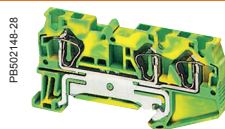
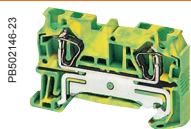

NSYTRR42PE		NSYTRR43PE		NSYTRR44PE		NSYTRR62PE	
4 mm ²		4 mm ²		4 mm ²		6 mm ²	
Protective earth		Protective earth		Protective earth		Protective earth	
1 pole - 1 x 1		1 pole - 1 x 2		1 pole - 2 x 2		1 pole - 1 x 1	
Green/Yellow		Green/Yellow		Green/Yellow		Green/Yellow	
-		-		-		-	
56		71.5		87		69.5	
36.5		36.5		36.5		43.5	
6.2		6.2		6.2		8.2	
4		4		4		6	
0.08 - 4		0.08 - 4		0.08 - 4		0.2 - 6	
0.08 - 6		0.08 - 6		0.08 - 6		0.08 - 4	
-		-		-		-	
28 - 10 AWG		28 - 10 AWG		28 - 10 AWG		24 - 8 AWG	
28 - 10 AWG		28 - 10 AWG		28 - 10 AWG		24 - 8 AWG	
-		-		-		-	
UL, CSA, VDE, ATEX, IECEx, GL, LR, DNV, EAC		UL, CSA, VDE, ATEX, IECEx, GL, LR, DNV, EAC		UL, CSA, VDE, ATEX, IECEx, GL, LR, DNV, EAC		UL, CSA, VDE, ATEX, IECEx, GL, LR, DNV, EAC	
Sold in lots of	Unit reference	Sold in lots of	Unit reference	Sold in lots of	Unit reference	Sold in lots of	Unit reference
50	NSYTRR42PE	50	NSYTRR43PE	50	NSYTRR44PE	50	NSYTRV62PE
50	NSYTRAAB35	50	NSYTRAAB35	50	NSYTRAAB35	50	NSYTRAAB35
50	NSYTRAABV35	50	NSYTRAABV35	50	NSYTRAABV35	50	NSYTRAABV35
50	NSYTRACR42	50	NSYTRACR43	50	NSYTRACR44	50	NSYTRACR62
-	-	-	-	-	-	-	-
50	NSYTRAPR42	-	-	-	-	-	-
-	-	-	-	-	-	-	-
-	-	-	-	-	-	10	NSYTRAL62
-	-	-	-	-	-	10	NSYTRAL63
-	-	-	-	-	-	10	NSYTRAL610
10	NSYTRAATM1	10	NSYTRAATM1	10	NSYTRAATM1	10	NSYTRAATM1
10	NSYTRAATP1	10	NSYTRAATP1	10	NSYTRAATP1	10	NSYTRAATP1
10	NSYTRAFT	10	NSYTRAFT	10	NSYTRAFT	10	NSYTRAFT
10	NSYTRACSR4	10	NSYTRACSR4	10	NSYTRACSR4	10	NSYTRACSR6
100	NSYTRASB4	100	NSYTRASB4	100	NSYTRASB4	100	NSYTRASB4
20	NSYSDR200BD	20	NSYSDR200BD	20	NSYSDR200BD	20	NSYSDR200BD
10		10		10		12	

Spring terminal blocks - Protective earth

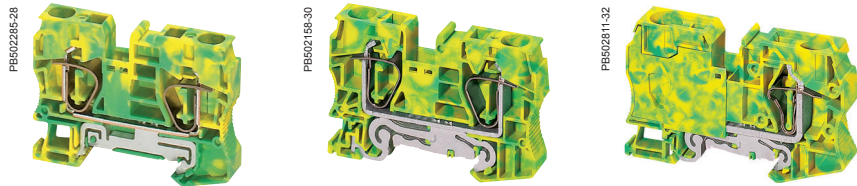

	NSYTRR102PE	NSYTRR162PE	NSYTRR352PE				
Nominal c.s.a.	10 mm ²	16 mm ²	35 mm ²				
Type of block	Protective earth	Protective earth	Protective earth				
Type of connection	1 pole - 1 x 1	1 pole - 1 x 1	1 pole - 1 x 1				
Colour	Green/Yellow	Green/Yellow	Green/Yellow				
Max. electric values	-	-	1000 V, 125 A				
Dimensions (mm)							
Length	71.5	80	100				
Height	50.5	51	59				
Width	10.2	12.2	16				
Cabling c.s.a. (mm ²)	10	16	35				
Flexible cable	0.2 - 10	0.2 - 16	2.5 - 35				
Solid cable	0.2 - 16	0.2 - 25	2.5 - 35				
Nominal electric values							
IEC/EN 60947-7-1	-	-	-				
UL	16 - 6 AWG	16 - 4 AWG	14 - 2 AWG				
CSA	16 - 6 AWG	16 - 4 AWG	14 - 2 AWG				
ATEX	-	-	-				
Certifications	UL, CSA, VDE, ATEX, IECEx, GL, LR, DNV, EAC	UL, CSA, VDE, ATEX, IECEx, GL, LR, DNV, EAC	UL, CSA, EAC				
Terminal blocks							
	Sold in lots of	Unit reference	Sold in lots of	Unit reference	Sold in lots of	Unit reference	
Green/Yellow	50	NSYTRR102PE	25	NSYTRR162PE	10	NSYTRR352PE	
Accessories							
End stop for 35mm DIN rail	Clip-on, 5.2 mm	50	NSYTRAAB35	50	NSYTRAAB35	50	NSYTRAAB35
	With screw, 9.5 mm	50	NSYTRAABV35	50	NSYTRAABV35	50	NSYTRAABV35
End plate, width 2.2 mm	Grey	50	NSYTRACR102	50	NSYTRACR162	-	included
	Blue	-	-	-	-	-	-
Partition plate, width 2 mm	Grey	-	-	-	-	-	-
	Blue	-	-	-	-	-	-
Plug-in bridge Red	2-pole	10	NSYTRAL102	10	NSYTRAL162	10	NSYTRAL352
	3-pole	-	-	-	-	-	-
	10-pole	-	-	-	-	-	-
Test plug	Metallic part, Ø 2.3 mm	10	NSYTRAATM1	-	-	-	-
	Insulating sleeve, red	10	NSYTRAATP1	-	-	-	-
Test adaptor	For plug-in bridge shaft	10	NSYTRAFT	-	-	-	-
Warning label	Yellow	10	NSYTRACSR10	10	NSYTRACSR10	10	NSYTRACSR10
Marker tag holder	For ●AB35 end stop	100	NSYTRASB4	100	NSYTRASB4	100	NSYTRASB4
DIN rail 35 x 7.2 mm	Perforated, 2 m long	20	NSYS DR200BD	20	NSYS DR200BD	20	NSYS DR200BD
Marking accessories	See page 142						
General data							
Strip length (mm)	18	18	25				



Spring terminal blocks - Double deck passthrough



		NSYTRR24D	
Nominal c.s.a.	Type of block	2.5 mm ²	
	Type of connection	Passthrough - Double deck	
	Type of connection	2 pole - 1 x 1	
	Colour	Grey	
Max. electric values (U _{max} , I _{max})		500 V, 26 A	
Dimensions (mm)			
	Length	78	
	Height	55	
	Width	5.2	
Cabling c.s.a. (mm ²)		2.5	
	Flexible cable	0.08 - 2.5	
	Solid cable	0.08 - 4	
Nominal electric values			
	IEC/EN 60947-7-1	500 V, 22 A	
	UL	600 V, 20 A, 28 - 12 AWG	
	CSA	600 V, 20 A, 28 - 12 AWG	
	ATEX	440 V, 19,5 A	
Certifications (1)		UL, CSA, VDE, GL, LR, DNV, EAC	
Terminal blocks			
		Sold in lots of	Unit reference
	Grey	50	NSYTRR24D
	Blue	50	NSYTRR24DBL
Accessories			
1	End stop	Clip-on, 5.2 mm	50 NSYTRAAB35
2	for 35 mm DIN rail	With screw, 9.5 mm	50 NSYTRAABV35
3	End plate, width 2.2 mm	Grey	50 NSYTRACRE24
		Blue	-
5	Plug-in bridge	Red	-
		2-pole	50 NSYTRAL22
		3-pole	50 NSYTRAL23
		4-pole	50 NSYTRAL24
		5-pole	50 NSYTRAL25
		10-pole	10 NSYTRAL210
6	Vertical bridge	1-pole	50 NSYTRALV24R
			10 NSYTRAL220
8	Test plug	Metallic part, Ø 2.3 mm	10 NSYTRAATM1
		Insulating sleeve, red	10 NSYTRAATP1
9	Test adaptor	For plug-in bridge shaft	10 NSYTRAFT
10	Warning label	Yellow	10 NSYTRACSR2
11	Marker tag holder	For ●AB35 end stop	100 NSYTRASB4
12	DIN rail 35x7.2mm	Perforated, 2m long	20 NSYSDR200BD
13	Marking accessories		See page 142
General data			
	Strip length (mm)	10	

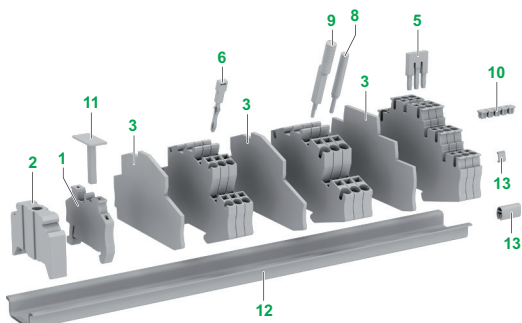

(1) ATEX and IECEx certifications pending.
* The 3 levels are connected.

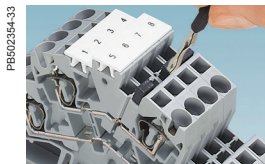

The **NSYTRALV24R** vertical bridge offers the option of connecting both levels of the standard double-level **NSYTRR24D** or **NSYTRR44D** terminal blocks.

PB602155-30

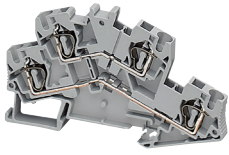

PB602155-33

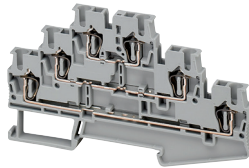

PB602155-33

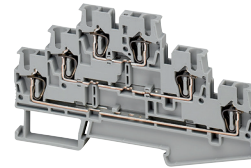

NSYTRR44D	NSYTRR26T	NSYTRR26TC
4 mm ²	2.5 mm ²	2.5 mm ²
Passthrough - Double deck	Passthrough - 3 Levels	Passthrough - 3 Levels
2 pole - 1 x 1	3 pole - 1 x 1	1 pole - 3 x 3
Grey	Grey	Grey
500 V, 34 A	500 V, 28 A	500 V, 28 A
92.4	99.5	99.5
55	58	58
6.2	5.2	5.2
4	2.5	2.5
0.08 - 4	0.08 - 2.5	0.08 - 2.5
0.08 - 6	0.08 - 4	0.08 - 4
500 V, 28 A	500 V, 20 A	500 V, 20 A
600 V, 30 A, 28 - 10 AWG	600 V, 20 A, 28 - 12 AWG	600 V, 20 A, 28 - 12 AWG
600 V, 30 A, 28 - 10 AWG	600 V, 20 A, 28 - 12 AWG	-
440 V, 22 A	-	-
UL, CSA, VDE, GL, LR, DNV, EAC	UL, CSA, VDE, GL, LR, EAC	UL, EAC

Sold in lots of	Unit reference	Sold in lots of	Unit reference	Sold in lots of	Unit reference
50	NSYTRR44D	50	NSYTRR26T	50	NSYTRR26TC*
50	NSYTRR44DBL	50	NSYTRR26TBL	-	-
50	NSYTRAAB35	50	NSYTRAAB35	50	NSYTRAAB35
50	NSYTRAABV35	50	NSYTRAABV35	50	NSYTRAABV35
50	NSYTRACRE44	50	NSYTRACRE26	50	NSYTRACRE26
-	-	-	-	-	-
50	NSYTRAL42	50	NSYTRAL22	50	NSYTRAL22
50	NSYTRAL43	50	NSYTRAL23	50	NSYTRAL23
50	NSYTRAL44	50	NSYTRAL24	50	NSYTRAL24
50	NSYTRAL45	50	NSYTRAL25	50	NSYTRAL25
10	NSYTRAL410	10	NSYTRAL210	10	NSYTRAL210
10	NSYTRAL420	10	NSYTRAL220	10	NSYTRAL220
50	NSYTRALV24R	-	-	-	-
10	NSYTRAATM1	10	NSYTRAATM1	10	NSYTRAATM1
10	NSYTRAATP1	10	NSYTRAATP1	10	NSYTRAATP1
10	NSYTRAFT	10	NSYTRAFT	10	NSYTRAFT
10	NSYTRACSR4	10	NSYTRACSR2	10	NSYTRACSR2
100	NSYTRASB4	100	NSYTRASB4	100	NSYTRASB4
20	NSYSDR200BD	20	NSYSDR200BD	20	NSYSDR200BD

10		10		10	
----	--	----	--	----	--

Spring terminal blocks - Double deck protective earth



		NSYTTR24DPE	NSYTTR44DPE	NSYTTR26TPE			
Nominal c.s.a.	Type of block	2.5 mm ²	4 mm ²	2.5 mm ²			
	Type of connection	Protective earth - Double deck	Protective earth - Double deck	Protective earth - 3 Levels			
	Type of connection	1 pole - 2 x 2	1 pole - 2 x 2	1 pole - 3 x 3			
	Colour	Green/Yellow	Green/Yellow	Green/Yellow			
Max. electric values		-	-	-			
Dimensions (mm)							
	Length	78	92.4	99.5			
	Height	55	55	58			
	Width	5.2	6.2	5.2			
Cabling c.s.a. (mm ²)		2.5	4	2.5			
	Flexible cable	0.08 - 2.5	0.08 - 4	0.08 - 2.5			
	Solid cable	0.08 - 4	0.08 - 6	0.08 - 4			
Nominal electric values							
	IEC/EN 60947-7-1	-	-	-			
	UL	28 - 12 AWG	28 - 10 AWG	28 - 12 AWG			
	CSA	28 - 12 AWG	28 - 10 AWG	28 - 12 AWG			
	ATEX	-	-	-			
Certifications (1)		UL, CSA, VDE, GL, LR, DNV, EAC	UL, CSA, VDE, GL, LR, DNV, EAC	UL, CSA, EAC			
Terminal blocks							
		Sold in lots of	Unit reference	Sold in lots of	Unit reference	Sold in lots of	Unit reference
Green/Yellow		50	NSYTTR24DPE	50	NSYTTR44DPE	50	NSYTTR26TPE
Accessories							
End stop for 35 mm DIN rail	Clip-on, 5.2 mm	50	NSYTRAAAB35	50	NSYTRAAAB35	50	NSYTRAAAB35
	With screw, 9.5 mm	50	NSYTRAAABV35	50	NSYTRAAABV35	50	NSYTRAAABV35
End plate, width 2.2 mm	Grey	50	NSYTRACRE24	50	NSYTRACRE44	50	NSYTRACRE26
	Blue	-	-	-	-	-	-
Plug-in bridge Red	2-pole	50	NSYTRAL22	50	NSYTRAL42	50	NSYTRAL22
	3-pole	50	NSYTRAL23	50	NSYTRAL43	50	NSYTRAL23
	4-pole	50	NSYTRAL24	50	NSYTRAL44	50	NSYTRAL24
	5-pole	50	NSYTRAL25	50	NSYTRAL45	50	NSYTRAL25
	10-pole	10	NSYTRAL210	10	NSYTRAL410	10	NSYTRAL210
	20-pole	10	NSYTRAL220	10	NSYTRAL420	10	NSYTRAL220
Test plug	Metallic part, Ø 2.3 mm	10	NSYTRAATM1	10	NSYTRAATM1	10	NSYTRAATM1
	Insulating sleeve, red	10	NSYTRAATP1	10	NSYTRAATP1	10	NSYTRAATP1
Test adaptor	For plug-in bridge shaft	10	NSYTRAFT	10	NSYTRAFT	10	NSYTRAFT
Warning label	Yellow	10	NSYTRACSR2	10	NSYTRACSR4	10	NSYTRACSR2
Marker tag holder	For ● AB35 end stop	100	NSYTRASB4	100	NSYTRASB4	100	NSYTRASB4
DIN rail 35 x 7.2 mm	Perforated, 2 m long	20	NSYSDR200BD	20	NSYSDR200BD	20	NSYSDR200BD
Marking accessories		See page 142					
General data							
	Strip length (mm)	10		10		10	

(1) ATEX and IECEx certifications pending.



Spring terminal blocks - Disconnect

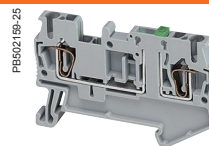

		NSYTRR22SC
Nominal c.s.a.		2.5 mm ²
	Type of block	Disconnect (blade)
	Type of connection	1 pole - 1 x 1
	Colour	Grey
Max. electric values (U _{max} , I _{max})		400 V, 20 A
Dimensions (mm)		
	Length	60.5
	Height	36.5
	Width	5.2
Cabling c.s.a. (mm ²)		2.5
	Flexible cable	0.08 - 2.5
	Solid cable	0.08 - 4
Nominal electric values		
	IEC/EN 60947-7-1	400 V, 20 A
	UL	600 V, 16 A, 28 - 12 AWG
	CSA	300 V, 16 A, 28 - 12 AWG
	ATEX	-
Certifications		UL, CSA, EAC

Terminal blocks		Sold in lots of	Unit reference
	Grey	50	NSYTRR22SC
	Orange	50	NSYTRR22SCAR

Accessories			
1	End stop	Clip-on, 5.2 mm	50 NSYTRAAB35
2	for 35 mm DIN rail	With screw, 9.5 mm	50 NSYTRAABV35
3	End plate, width 2.2 mm	Grey	50 NSYTRACR23
		Blue	-
4	Partition plate, width 2 mm	Grey	50 NSYTRAPR23
		Blue	-
5	Plug-in bridge Red	2-pole	50 NSYTRAL22
		3-pole	50 NSYTRAL23
		4-pole	50 NSYTRAL24
		5-pole	50 NSYTRAL25
		10-pole	10 NSYTRAL210
		20-pole	10 NSYTRAL220
14	Removable carrier width 6.1 mm 6 A max	For fuse 5 x 20 mm	-
		For fuse 5 x 20 mm 110 - 250 V LED	-
		For fuse 5 x 20 mm 12 - 30 V LED	-
15	Removable carrier width 5.1 mm 6 A max	For component	-
		With 1N4007 diode	-
8	Test plug	Metallic part, Ø 2.3 mm	10 NSYTRAATM1
		Insulating sleeve, red	10 NSYTRAATP1
9	Test adaptor	For plug-in bridge shaft	10 NSYTRAFT
10	Warning label	Yellow	50 NSYTRACSR2
11	Marker tag holder	For ●AB35 end stop	100 NSYTRASB4
12	DIN rail 35 x 7.2 mm	Perforated, 2 m long	20 NSYSDR200BD
13	Marking accessories		See page 142

General data	
Strip length (mm)	10

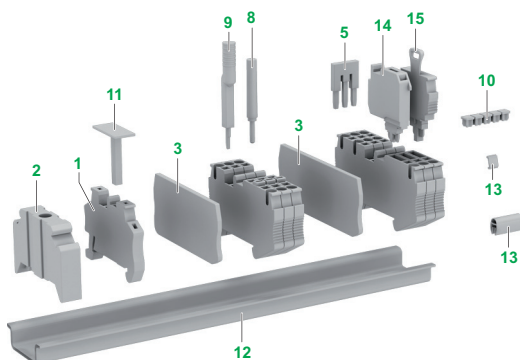

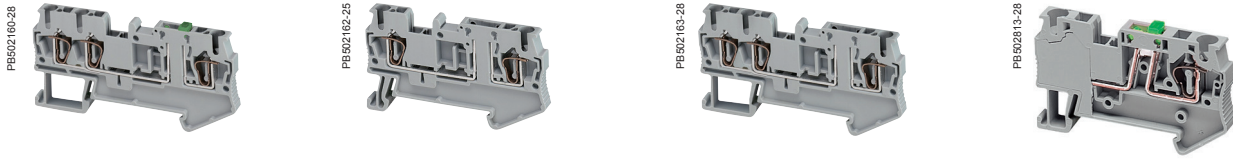

NSYTRR23SC		NSYTRR22TB		NSYTRR23TB		NSYTRR42SC	
2.5 mm ²		2.5 mm ²		2.5 mm ²		4 mm ²	
Disconnect (blade)		Disconnect (for carrier)		Disconnect (for carrier)		Disconnect (blade)	
1 pole - 1 x 2		1 pole - 1 x 1		1 pole - 1 x 2		1 pole - 1 x 1	
Grey		Grey		Grey		Grey	
400 V, 20 A		400 V, 20 A		400 V, 20 A		400 V; 20 A	
72		60.5		72		61.5	
36.5		36.5		36.5		36.5	
5.2		5.2		5.2		6.2	
2.5		2.5		2.5		2.5	
0.08 - 2.5		0.08 - 2.5		0.08 - 2.5		0.08 - 4	
0.08 - 4		0.08 - 4		0.08 - 4		0.08 - 6	
400 V, 20 A		400 V, 20 A		400 V, 20 A		400 V, 20 A	
600 V, 16 A, 28 - 12 AWG		300 V, 16 A, 28 - 12 AWG		300 V, 16 A, 28 - 12 AWG		300 V, 10 A, 28 - 10 AWG	
300 V, 16 A, 28 - 12 AWG		300 V, 16 A, 28 - 12 AWG		300 V, 16 A, 28 - 12 AWG		-	
-		-		-		-	
UL, CSA, EAC		UL, CSA, EAC		UL, CSA, EAC		UL, EAC	
Sold in lots of	Unit reference	Sold in lots of	Unit reference	Sold in lots of	Unit reference	Sold in lots of	Unit reference
50	NSYTRR23SC	50	NSYTRR22TB	50	NSYTRR23TB	50	NSYTRR42SC
50	NSYTRR23SCAR	-	-	-	-	50	NSYTRR42SCAR
50	NSYTRAAB35	50	NSYTRAAB35	50	NSYTRAAB35	50	NSYTRAAB35
50	NSYTRAABV35	50	NSYTRAABV35	50	NSYTRAABV35	50	NSYTRAABV35
50	NSYTRACR24	50	NSYTRACR23	50	NSYTRACR24	-	Included
-	-	-	-	-	-	-	-
50	NSYTRAPR24	50	NSYTRAPR23	50	NSYTRAPR24	50	NSYTRAPR23
-	-	-	-	-	-	-	-
50	NSYTRAL22	50	NSYTRAL22	50	NSYTRAL22	50	NSYTRAL42
50	NSYTRAL23	50	NSYTRAL23	50	NSYTRAL23	50	NSYTRAL43
50	NSYTRAL24	50	NSYTRAL24	50	NSYTRAL24	50	NSYTRAL44
50	NSYTRAL25	50	NSYTRAL25	50	NSYTRAL25	50	NSYTRAL45
10	NSYTRAL210	10	NSYTRAL210	10	NSYTRAL210	10	NSYTRAL410
10	NSYTRAL220	10	NSYTRAL220	10	NSYTRAL220	10	NSYTRAL420
-	-	10	NSYTRASF520	10	NSYTRASF520	-	-
-	-	10	NSYTRASF520M	10	NSYTRASF520M	-	-
-	-	10	NSYTRASF520B	10	NSYTRASF520B	-	-
-	-	10	NSYTRASV1	10	NSYTRASV1	-	-
-	-	10	NSYTRASV2	10	NSYTRASV2	-	-
10	NSYTRAATM1	10	NSYTRAATM1	10	NSYTRAATM1	10	NSYTRAATM1
10	NSYTRAATP1	10	NSYTRAATP1	10	NSYTRAATP1	10	NSYTRAATP1
10	NSYTRAFT	10	NSYTRAFT	10	NSYTRAFT	10	NSYTRAFT
50	NSYTRACSR2	50	NSYTRACSR2	50	NSYTRACSR2	50	NSYTRACSR4
100	NSYTRASB4	100	NSYTRASB4	100	NSYTRASB4	100	NSYTRASB4
20	NSYSDR200BD	20	NSYSDR200BD	20	NSYSDR200BD	20	NSYSDR200BD
10		10		10		10	

Spring terminal blocks - Disconnect

PB 502812-28

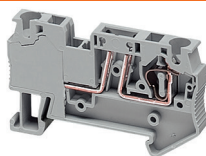

PB 502138-35

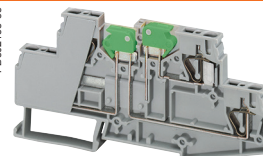

		NSYTRR42TB	NSYTRR24SCD		
Nominal c.s.a.		4 mm ²	2.5 mm ²		
	Type of block	Disconnect (for carrier)	Disconnect (blade)		
	Type of connection	1 pole - 1 x 1	2 pole - 1 x 1		
	Colour	Grey	Grey		
Max. electric values (U _{max} , I _{max})		400 V, 20 A	400 V, 16 A		
Dimensions (mm)					
	Length	61.5	107		
	Height	36.5	55		
	Width	6.2	5.2		
Cabling c.s.a. (mm ²)		2.5	2.5		
	Flexible cable	0.08 - 4	0.08 - 2.5		
	Solid cable	0.08 - 6	0.08 - 4		
Nominal electric values					
	IEC/EN 60947-7-1	400 V, 20 A	400 V, 16 A		
	UL	300 V, 10 A, 28 - 10 AWG	300 V, 10 A, 28 - 12 AWG		
	CSA	-	300 V, 10 A, 28 - 12 AWG		
	ATEX	-	-		
Certifications		UL, EAC	UL, CSA, EAC		
Terminal blocks					
		Sold in lots of	Unit reference	Sold in lots of	Unit reference
	Grey	50	NSYTRR42TB	50	NSYTRR24SCD
	Orange	-	-	-	-
Accessories					
End stop for 35 mm DIN rail	Clip-on, 5.2 mm	50	NSYTRAAB35	50	NSYTRAAB35
	With screw, 9.5 mm	50	NSYTRAABV35	50	NSYTRAABV35
End plate, width 2.2 mm	Grey	-	Included	-	Included
	Blue	-	-	-	-
Partition plate, width 2 mm	Grey	50	NSYTRAPR23	-	-
	Blue	-	-	-	-
Plug-in bridge Red	2-pole	50	NSYTRAL42	-	-
	3-pole	50	NSYTRAL43	-	-
	4-pole	50	NSYTRAL44	-	-
	5-pole	50	NSYTRAL45	-	-
	10-pole	10	NSYTRAL410	-	-
	20-pole	10	NSYTRAL420	-	-
Removable carrier width 6.1 mm	For fuse 5 x 20 mm	10	NSYTRASF520	-	-
	For fuse 5 x 20 mm 110 - 250 V LED	10	NSYTRASF520M	-	-
	For fuse 5 x 20 mm 12 - 30 V LED	10	NSYTRASF520B	-	-
Removable carrier width 5.1 mm	For component	10	NSYTRASV1	-	-
	With 1N4007 diode	10	NSYTRASV2	-	-
Test plug	Metallic part, Ø 2.3 mm	10	NSYTRAATM1	10	NSYTRAATM1
	Insulating sleeve, red	10	NSYTRAATP1	10	NSYTRAATP1
Test adaptor	For plug-in bridge shaft	10	NSYTRAFT	10	NSYTRAFT
Warning label	Yellow	50	NSYTRACSR4	50	NSYTRACSR2
Marker tag holder	For ●AB35 end stop	100	NSYTRASB4	100	NSYTRASB4
DIN rail 35 x 7.2 mm	Perforated, 2 m long	20	NSYSDR200BD	20	NSYSDR200BD
Marking accessories		See page 142			
General data					
	Strip length (mm)	10		10	



Spring terminal blocks - Miniature passthrough and miniature protective E

DIN rail mounting

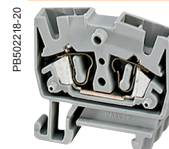

		NSYTRR22M
Nominal c.s.a.	Type of block	Passthrough
	Type of connection	1 pole - 1 x 1
	Colour	Grey
	Max. electric values (U _{max} , I _{max})	800 V, 30 A
Dimensions (mm)		
	Length	32
	Height	30
	Width	5.2
Mounting on		NS15 Din rail
Cabling c.s.a. (mm ²)		2.5
	Flexible cable	0.08 - 2.5
	Solid cable	0.08 - 4
Nominal electric values		
	IEC/EN 60947-7-1	800 V, 24 A
	UL	600 V, 20 A, 28 - 12 AWG
	CSA	600 V, 20 A, 28 - 12 AWG
	ATEX	690 V, 22 A
Certifications (1)		UL, CSA, EAC

Terminal blocks



		Sold in lots of	Unit reference
or			
	Grey	50	NSYTRR22M
	Blue	50	NSYTRR22MBL
	Grey, with flange	-	-

Accessories

1	End stop for 15 mm DIN rail	Clip-on, 5.2 mm	50	NSYTRAAB15
3	End plate, width 2.2 mm	Grey	50	NSYTRACRM22
		Grey, with flange	-	-
5	Insertion bridge	2-pole	-	-
11	Marker tag holder	For ●AB15 end stop	100	NSYTRASB4
12	DIN rail 15 x 7.2 mm	Perforated, 2 m long	10	NSYTRADR155
13	Marking accessories (for all mini spring terminals)			Only for NSYTRABF●. See page 141

General data

Strip length (mm)	8
Plate thickness (mm)	-
Hole diameter (mm)	-

(1) ATEX and IECEx certifications pending.

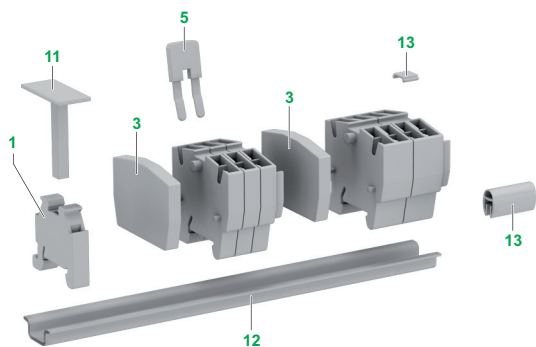

Earth

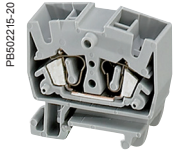

NSYTRR24M		NSYTRR22MPE	
2.5 mm ²		2.5 mm ²	
Passthrough		Protective earth	
1 pole - 2 x 2		1 pole - 1 x 1	
Grey		Green/Yellow	
800 V, 30 A		-	
32		32	
30		30	
10.4		5.2	
NS15 Din rail		NS15 Din rail	
2.5		2.5	
0.08 - 2.5		0.08 - 2.5	
0.08 - 4		0.08 - 4	
800 V, 24 A		-	
600 V, 20 A, 28 - 12 AWG		28 - 12 AWG	
600 V, 20 A, 28 - 12 AWG		28 - 12 AWG	
690 V, 22 A		-	
UL, CSA, EAC		UL, CSA, EAC	
Sold in lots of	Unit reference	Sold in lots of	Unit reference
50	NSYTRR24M	50	NSYTRR22MPE
50	NSYTRR24MBL	-	-
-	-	-	-
50	NSYTRAAB15	50	NSYTRAAB15
50	NSYTRACRM22	50	NSYTRACRM22
-	-	-	-
10	NSYTRALM22	-	-
100	NSYTRASB4	100	NSYTRASB4
10	NSYTRADR155	10	NSYTRADR155
8		8	
-		-	
-		-	

Spring terminal blocks - Miniature passthrough and miniature protective E

Direct mounting (flange)



		NSYTRR22MF
Nominal c.s.a.	Type of block	2.5 mm ²
	Type of connection	Passthrough
	Type of connection	1 pole - 1 x 1
	Colour	Grey
Max. electric values (U _{max} , I _{max})		800 V, 30 A

Dimensions (mm)

Length	32
Height	22
Width	5.2

Mounting on	Direct mounting
-------------	-----------------

Cabling c.s.a. (mm ²)		2.5
	Flexible cable	0.08 - 2.5
	Solid cable	0.08 - 4

Nominal electric values

IEC/EN 60947-7-1	800 V, 24 A
UL	600 V, 20 A, 28 - 12 AWG
CSA	600 V, 20 A, 28 - 12 AWG
ATEX	550 V, 22 A

Certifications (1)	UL, CSA, EAC
--------------------	--------------

Terminal blocks

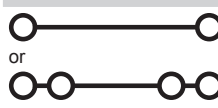

		Sold in lots of	Unit reference
Grey		50	NSYTRR22MF
Blue		50	NSYTRR22MFBL
Grey, with flange		50	NSYTRR22MFF (2)

Accessories

1 End stop for 15 mm DIN rail	Clip-on, 5.2 mm	-	-
3 End plate, width 2.2 mm	Grey	50	NSYTRACRM22
	Grey, with flange	50	NSYTRACRMF22 (2)
5 Insertion bridge Grey	2-pole	-	-
11 Marker tag holder	For ●AB15 end stop	100	NSYTRASB4
12 DIN rail 15 x 7.2 mm	Perforated, 2 m long	-	-
13 Marking accessories (for all mini spring terminals)			Only for NSYTRABF● . See page 141

General data

Strip length (mm)	8
Plate thickness (mm)	-
Hole diameter (mm)	-

(1) ATEX and IECEx certifications pending.

(2) Can only be used at the end of a group of terminals.

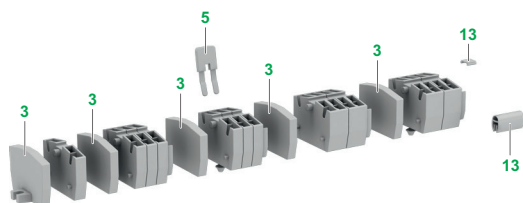

Earth

For micro-perforated mounting plates

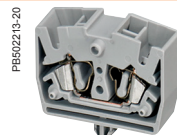

NSYTRR24MF

2.5 mm²

Passthrough

1 pole - 2 x 2

Grey

800 V, 30 A

NSYTRR22MP

2.5 mm²

Passthrough

1 pole - 1 x 1

Grey

800 V, 30 A

NSYTRR24MP

2.5 mm²

Passthrough

1 pole - 2 x 2

Grey

800 V, 30 A

32

22

10.4

Direct mounting

2.5

0.08 - 2.5

0.08 - 4

32

22

5.2

Pin mounting

2.5

0.08 - 2.5

0.08 - 4

32

22

10.4

Pin mounting

2.5

0.08 - 2.5

0.08 - 4

800 V, 24 A

600 V, 20 A, 28 - 12 AWG

600 V, 20 A, 28 - 12 AWG

550 V, 22 A

UL, CSA, EAC

800 V, 24 A

600 V, 20 A, 28 - 12 AWG

600 V, 20 A, 28 - 12 AWG

550 V, 22 A

UL, CSA, EAC

800 V, 24 A

600 V, 20 A, 28 - 12 AWG

600 V, 20 A, 28 - 12 AWG

550 V, 22 A

UL, CSA, EAC

Sold in lots of

Unit reference

50

NSYTRR24MF

50

NSYTRR24MFBL

50

NSYTRR24MFF (2)

Sold in lots of

Unit reference

50

NSYTRR22MP

50

NSYTRR22MPBL

-

-

Sold in lots of

Unit reference

10

NSYTRR24MP

10

NSYTRR24MPBL

-

-

-

-

-

-

-

-

50

NSYTRACRM22

50

NSYTRACRM22

50

NSYTRACRM22

50

NSYTRACRMF22 (2)

-

-

-

-

10

NSYTRALM22

-

-

10

NSYTRALM22

100

NSYTRASB4

100

NSYTRASB4

100

-

-

-

-

-

-

-

8

-

-

8





0.6 - 1.5

3.5

8

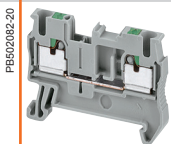
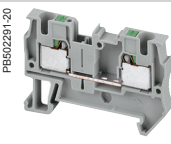
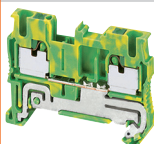
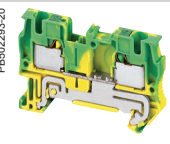
0.6 - 1.5

3.5

Push-in		Passthrough		Protective earth	
		Passthrough			
					
Nominal c.s.a (mm ²)		2.5	4	2.5	4
Number of poles	1 - 1 x 1	NSYTRP22	NSYTRP42	NSYTRP22PE	NSYTRP42PE
	1 - 1 x 2	NSYTRP23	NSYTRP43	NSYTRP23PE	NSYTRP43PE
	1 - 2 x 2	NSYTRP24	NSYTRP44	NSYTRP24PE	NSYTRP44PE
	1 - 2 x 4	-	-	-	-
	1 - 3 x 3	-	-	-	-
	2 - 1 x 1	-	-	-	-
	2 - 1 x 2	-	-	-	-
	3 - 1 x 1	-	-	-	-
Colours	Grey	■	■	-	-
	Blue	NSYTRP22BL NSYTRP23BL NSYTRP24BL	NSYTRP42BL NSYTRP43BL NSYTRP44BL	-	-
	Green/yellow (PE)	-	-	■	■
	Orange	NSYTRP22AR NSYTRP23AR	-	-	-
	Black	-	-	-	-
	With flange	-	-	-	-
	Mounting on	35 mm 	■	■	■
	35 mm 	■	■	■	■
	Telequick	-	-	-	-
	15 mm 	-	-	-	-
See pages		128/129	129/130	132	133

PB502360-70

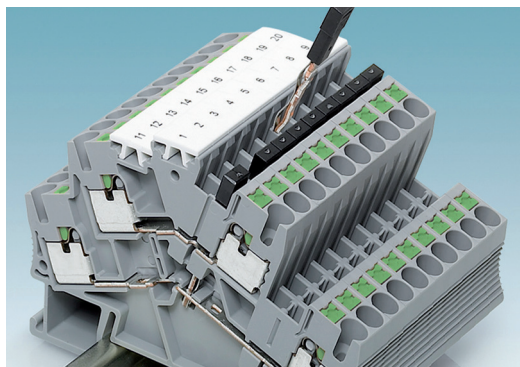

Vertical bridge

The **NSYTRALV24R** vertical bridge offers the option of connecting both levels of the standard double-level **NSYTRP24D** terminal block.

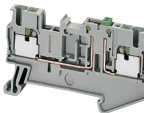
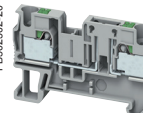
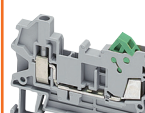
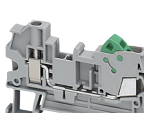
	Double deck	Disconnect		Hybrid: Screw - IDC connection	
		Blade	Removable carrier	Passthrough	
					
	2.5	2.5	2.5 & 4	1.5	2.5
	-	NSYTRP22SC	NSYTRP22TB NSYTRP42TB	NSYTRH12	NSYTRH22
	-	NSYTRP23SC	-	NSYTRH13	-
	-	NSYTRP24SC	-	-	-
	-	-	-	-	-
	NSYTRP24D	-	-	-	-
	-	-	-	-	-
	-	-	-	-	-
	■	■	■	■	■
	NSYTRP24DBL	-	-	-	-
	NSYTRP24DPE	-	-	NSYTRH12PE	-
	-	-	-	-	-
	-	-	-	-	-
	■	■	■	-	-
	■	■	■	-	-
	-	-	-	-	-
	-	-	-	■	■
	134	136/137	137	138/139	139

Push-in terminal - Passthrough

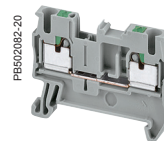

		NSYTRP22		
Nominal c.s.a.	Nominal c.s.a.	2.5 mm ²		
	Type of block	Passthrough		
	Type of connection	1 pole - 1 x 1		
	Colour	Grey		
Max. electric values (U _{max} , I _{max})	800 V, 30 A			
Dimensions (mm)				
	Length	48.5		
	Height	36.5		
	Width	5.2		
Cabling c.s.a. (mm ²)	Cabling c.s.a. (mm ²)	2.5		
	Flexible cable	0.14 - 2.5		
	Solid cable	0.14 - 4		
Nominal electric values				
	IEC/EN 60947-7-1	800 V, 24 A		
	UL	600 V, 20 A, 24 -12 AWG		
	CSA	600 V, 20 A, 24 -12 AWG		
	ATEX	550 V, 22 A		
Certifications	UL, CSA, VDE, ATEX, IECEX, GL, LR, EAC			
Terminal blocks				
		Sold in lots of	Unit reference	
	Grey	50	NSYTRP22	
	Blue	50	NSYTRP22BL	
	Orange	50	NSYTRP22AR	
Accessories				
1	End stop	Clip-on, 5.2 mm	50	NSYTRAAB35
2	for 35 mm DIN rail	With screw, 9.5 mm	50	NSYTRAABV35
3	End plate	Grey	50	NSYTRACR22
		width 2.2 mm Blue	50	NSYTRACR22BL
4	Partition plate	Grey	50	NSYTRAPR42
		width 2 mm Blue	-	-
5	Plug-in bridge	Red	50	NSYTRAL22
		3-pole	50	NSYTRAL23
		4-pole	50	NSYTRAL24
		5-pole	50	NSYTRAL25
		10-pole	10	NSYTRAL210
		20-pole	10	NSYTRAL220
		Blue	10-pole	10
Grey	10-pole	10	NSYTRAL210GR	
6	Step-down bridge, down to 2.5/4 mm ²	Screw to screw terminal	-	-
		Spring to spring terminal	-	-
8	Test plug	Metallic part, Ø 2.3 mm	10	NSYTRAATM1
		Insulating sleeve, red	10	NSYTRAATP1
9	Test adaptor	For plug-in bridge shaft	10	NSYTRAFT
11	Marker tag holder	For ●AB35 end stop	100	NSYTRASB4
12	DIN rail 35 x 7.2 mm	Perforated, 2 m long	20	NSYSR200BD
13	Marking accessories		See page 142	
General data				
	Strip length (mm)	10		

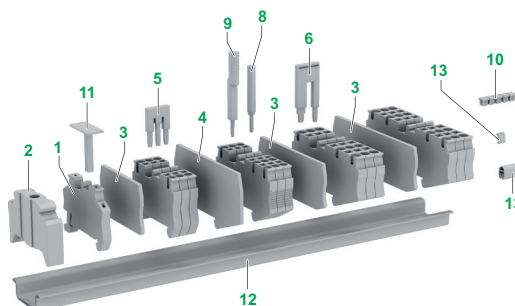

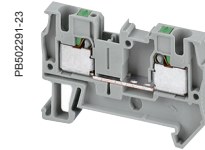
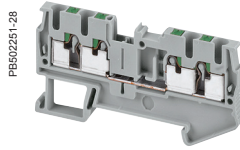
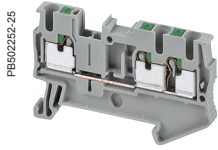

NSYTRP23	NSYTRP24	NSYTRP42
2.5 mm ²	2.5 mm ²	4 mm ²
Passthrough	Passthrough	Passthrough
1 pole - 1 x 2	1 pole - 2 x 2	1 pole - 1 x 1
Grey	Grey	Grey
800 V, 30 A	800 V, 30 A	800 V, 38 A

60.5	72	56
36.5	36.5	36.5
5.2	5.2	6.2
2.5	2.5	4
0.14 - 2.5	0.14 - 2.5	0.2 - 4
0.14 - 4	0.14 - 4	0.2 - 6

800 V, 24 A	800 V, 24 A	800 V, 32 A
600 V, 20 A, 24 -12 AWG	600 V, 20 A, 24 -12 AWG	600 V, 30 A, 24 - 10 AWG
600 V, 20 A, 24 -12 AWG	600 V, 20 A, 24 -12 AWG	600 V, 30 A, 24 - 10 AWG
550 V, 22 A	550 V, 22 A	550 V, 29 A
UL, CSA, VDE, ATEX, IECEX, GL, LR, EAC	UL, CSA, VDE, ATEX, IECEX, GL, LR, EAC	UL, CSA, ATEX, IECEX, GL, LR, EAC

Sold in lots of	Unit reference	Sold in lots of	Unit reference	Sold in lots of	Unit reference
50	NSYTRP23	50	NSYTRP24	50	NSYTRP42
50	NSYTRP23BL	50	NSYTRP24BL	50	NSYTRP42BL
50	NSYTRP23AR	-	-	-	-

50	NSYTRAAB35	50	NSYTRAAB35	50	NSYTRAAB35
50	NSYTRAABV35	50	NSYTRAABV35	50	NSYTRAABV35
50	NSYTRACR23	50	NSYTRACR24	50	NSYTRACR42
50	NSYTRACR23BL	50	NSYTRACR24BL	-	-
50	NSYTRAPR23	50	NSYTRAPR24	50	NSYTRAPR42
-	-	-	-	-	-
50	NSYTRAL22	50	NSYTRAL22	50	NSYTRAL42
50	NSYTRAL23	50	NSYTRAL23	50	NSYTRAL43
50	NSYTRAL24	50	NSYTRAL24	50	NSYTRAL44
50	NSYTRAL25	50	NSYTRAL25	50	NSYTRAL45
10	NSYTRAL210	10	NSYTRAL210	10	NSYTRAL410
10	NSYTRAL220	10	NSYTRAL220	10	NSYTRAL420
10	NSYTRAL210BL	10	NSYTRAL210BL	10	NSYTRAL410BL
10	NSYTRAL210GR	10	NSYTRAL210GR	10	NSYTRAL410GR
-	-	-	-	-	-
-	-	-	-	-	-
10	NSYTRAATM1	10	NSYTRAATM1	10	NSYTRAATM1
10	NSYTRAATP1	10	NSYTRAATP1	10	NSYTRAATP1
10	NSYTRAFT	10	NSYTRAFT	10	NSYTRAFT
100	NSYTRASB4	100	NSYTRASB4	100	NSYTRASB4
20	NSYSR200BD	20	NSYSR200BD	20	NSYSR200BD

10	10	12
----	----	----

Push-in terminal - Passthrough

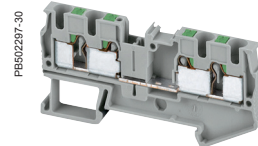
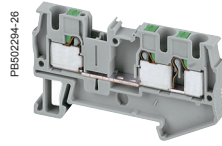

		NSYTRP43	NSYTRP44		
Nominal c.s.a.		4 mm ²	4 mm ²		
	Type of block	Passthrough	Passthrough		
	Type of connection	1 pole - 1 x 2	1 pole - 2 x 2		
	Colour	Grey	Grey		
Max. electric values (U _{max} , I _{max})		800 V, 38 A	800 V, 38 A		
Dimensions (mm)					
	Length	66.5	77		
	Height	36.5	36.5		
	Width	6.2	6.2		
Cabling c.s.a. (mm ²)		4	4		
	Flexible cable	0.2 - 4	0.2 - 4		
	Solid cable	0.2 - 6	0.2 - 6		
Nominal electric values					
	IEC/EN 60947-7-1	800 V, 32 A	800 V, 32 A		
	UL	600 V, 30 A, 24 - 10 AWG	600 V, 30 A, 24 - 10 AWG		
	CSA	600 V, 30 A, 24 - 10 AWG	600 V, 30 A, 24 - 10 AWG		
	ATEX	550 V, 29 A	550 V, 29 A		
Certifications		UL, CSA, ATEX, IECEx, GL, LR, EAC	UL, CSA, ATEX, IECEx, GL, LR, EAC		
Terminal blocks					
		Sold in lots of	Unit reference	Sold in lots of	Unit reference
	Grey	50	NSYTRP43	50	NSYTRP44
	Blue	50	NSYTRP43BL	50	NSYTRP44BL
	Orange	-	-	-	-
Accessories					
End stop	Clip-on, 5.2 mm	50	NSYTRAAB35	50	NSYTRAAB35
for 35 mm DIN rail	With screw, 9.5 mm	50	NSYTRAABV35	50	NSYTRAABV35
End plate	Grey	50	NSYTRACP43	50	NSYTRACP44
width 2.2 mm	Blue	-	-	-	-
Partition plate	Grey	-	-	-	-
width 2 mm	Blue	-	-	-	-
Plug-in bridge	2-pole	50	NSYTRAL42	50	NSYTRAL42
	3-pole	50	NSYTRAL43	50	NSYTRAL43
	4-pole	50	NSYTRAL44	50	NSYTRAL44
	5-pole	50	NSYTRAL45	50	NSYTRAL45
	10-pole	10	NSYTRAL410	10	NSYTRAL410
	20-pole	10	NSYTRAL420	10	NSYTRAL420
	Blue	10-pole	10	NSYTRAL410BL	10
Grey	10-pole	10	NSYTRAL410GR	10	NSYTRAL410BL
Step-down bridge, down to 2.5/4 mm ²	Screw to screw terminal	-	-	-	-
	Spring to spring terminal	-	-	-	-
Test plug	Metallic part, Ø 2.3 mm	10	NSYTRAATM1	10	NSYTRAATM1
	Insulating sleeve, red	10	NSYTRAATP1	10	NSYTRAATP1
Test adaptor	For plug-in bridge shaft	10	NSYTRAFT	10	NSYTRAFT
Marker tag holder	For ●AB35 end stop	100	NSYTRASB4	100	NSYTRASB4
DIN rail 35 x 7.2 mm	Perforated, 2 m long	20	NSYSDR200BD	20	NSYSDR200BD
Marking accessories		See page 142			
General data					
	Strip length (mm)	12		12	



Push-in terminal blocks - Protective earth

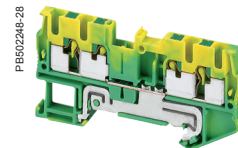
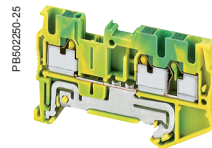
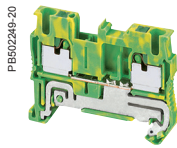

		NSYTRP22PE	NSYTRP23PE	NSYTRP24PE			
Nominal c.s.a.		2.5 mm ²	2.5 mm ²	2.5 mm ²			
	Type of block	Protective earth	Protective earth	Protective earth			
	Type of connection	1 pole - 1 x 1	1 pole - 1 x 2	1 pole - 2 x 2			
	Colour	Green/Yellow	Green/Yellow	Green/Yellow			
Max. electric values		-	-	-			
Dimensions (mm)							
	Length	48.5	60.5	72			
	Height	36.5	36.5	36.5			
	Width	5.2	5.2	5.2			
Cabling c.s.a. (mm ²)		2.5	2.5	2.5			
	Flexible cable	0.08 - 2.5	0.08 - 2.5	0.08 - 2.5			
	Solid cable	0.08 - 4	0.08 - 4	0.08 - 4			
Nominal electric values							
	IEC/EN 60947-7-1	-	-	-			
	UL	24 - 12 AWG	24 - 12 AWG	24 - 12 AWG			
	CSA	24 - 12 AWG	24 - 12 AWG	24 - 12 AWG			
	ATEX	-	-	-			
Certifications		UL, CSA, VDE, ATEX, IECEx, GL, LR, EAC	UL, CSA, VDE, ATEX, IECEx, GL, LR, EAC	UL, CSA, VDE, ATEX, IECEx, GL, LR, EAC			
Terminal blocks							
		Sold in lots of	Unit reference	Sold in lots of	Unit reference	Sold in lots of	Unit reference
	Green/Yellow	50	NSYTRP22PE	50	NSYTRP23PE	50	NSYTRP24PE
Accessories							
End stop for 35 mm DIN rail	Clip-on, 5.2 mm	50	NSYTRAAB35	50	NSYTRAAB35	50	NSYTRAAB35
	With screw, 9.5 mm	50	NSYTRAABV35	50	NSYTRAABV35	50	NSYTRAABV35
End plate, width 2.2 mm	Grey	50	NSYTRACR22	50	NSYTRACR23	50	NSYTRACR24
	Blue	50	NSYTRACR22BL	50	NSYTRACR23BL	50	NSYTRACR24BL
Partition plate, width 2 mm	Grey	50	NSYTRAPR42	50	NSYTRAPR23	50	NSYTRAPR24
	Blue	-	-	-	-	-	-
Plug-in bridge Red	2-pole	50	NSYTRAL22	50	NSYTRAL22	50	NSYTRAL22
	3-pole	50	NSYTRAL23	50	NSYTRAL23	50	NSYTRAL23
	4-pole	50	NSYTRAL24	50	NSYTRAL24	50	NSYTRAL24
	5-pole	50	NSYTRAL25	50	NSYTRAL25	50	NSYTRAL25
	10-pole	10	NSYTRAL210	10	NSYTRAL210	10	NSYTRAL210
	20-pole	10	NSYTRAL220	10	NSYTRAL220	10	NSYTRAL220
Test plug	Metallic part, Ø 2.3 mm	10	NSYTRAATM1	10	NSYTRAATM1	10	NSYTRAATM1
	Insulating sleeve, red	10	NSYTRAATP1	10	NSYTRAATP1	10	NSYTRAATP1
Test adaptor	For plug-in bridge shaft	10	NSYTRAFT	10	NSYTRAFT	10	NSYTRAFT
Marker tag holder	For ●AB35 end stop	100	NSYTRASB4	100	NSYTRASB4	100	NSYTRASB4
DIN rail 35 x 7.2 mm	Perforated, 2 m long	20	NSYSDR200BD	20	NSYSDR200BD	20	NSYSDR200BD
Marking accessories		See page 142					
General data							
	Strip length (mm)	10		10		10	

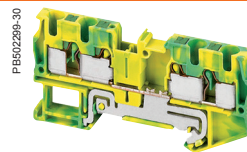
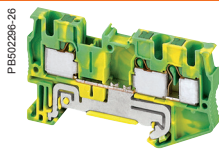
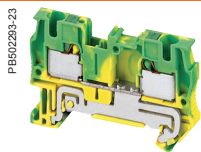

NSYTRP42PE		NSYTRP43PE		NSYTRP44PE	
4 mm ²		4 mm ²		4 mm ²	
Protective earth		Protective earth		Protective earth	
1 pole - 1 x 1		1 pole - 1 x 2		1 pole - 2 x 2	
Green/Yellow		Green/Yellow		Green/Yellow	
-		-		-	
56		66.5		77	
36.5		36.5		36.5	
6.2		6.2		6.2	
4		4		4	
0.08 - 4		0.08 - 4		0.08 - 4	
0.08 - 6		0.08 - 6		0.08 - 6	
-		-		-	
24 - 10 AWG		24 - 10 AWG		24 - 10 AWG	
24 - 10 AWG		24 - 10 AWG		24 - 10 AWG	
-		-		-	
UL, CSA, ATEX, IECEX, GL, LR, EAC		UL, CSA, ATEX, IECEX, GL, LR, EAC		UL, CSA, ATEX, IECEX, GL, LR, EAC	

Sold in lots of	Unit reference	Sold in lots of	Unit reference	Sold in lots of	Unit reference
50	NSYTRP42PE	50	NSYTRP43PE	50	NSYTRP44PE
50	NSYTRAAB35	50	NSYTRAAB35	50	NSYTRAAB35
50	NSYTRAABV35	50	NSYTRAABV35	50	NSYTRAABV35
50	NSYTRACR42	50	NSYTRACP43	50	NSYTRACP44
-	-	-	-	-	-
50	NSYTRAPR42	-	-	-	-
-	-	-	-	-	-
50	NSYTRAL42	50	NSYTRAL42	50	NSYTRAL42
50	NSYTRAL43	50	NSYTRAL43	50	NSYTRAL43
50	NSYTRAL44	50	NSYTRAL44	50	NSYTRAL44
50	NSYTRAL45	50	NSYTRAL45	50	NSYTRAL45
10	NSYTRAL410	10	NSYTRAL410	10	NSYTRAL410
10	NSYTRAL420	10	NSYTRAL420	10	NSYTRAL420
10	NSYTRAATM1	10	NSYTRAATM1	10	NSYTRAATM1
10	NSYTRAATP1	10	NSYTRAATP1	10	NSYTRAATP1
10	NSYTRAFT	10	NSYTRAFT	10	NSYTRAFT
100	NSYTRASB4	100	NSYTRASB4	100	NSYTRASB4
20	NSYSDR200BD	20	NSYSDR200BD	20	NSYSDR200BD

12		12		12	
----	--	----	--	----	--

Push-in terminal blocks - Double deck passthrough

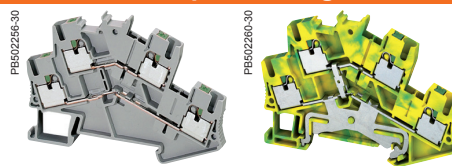

	NSYTRP24D	NSYTRP24DPE
Nominal c.s.a.	2.5 mm ²	2.5 mm ²
Type of block	Passthrough - Double deck	Protective earth - Double deck
Type of connection	2 pole - 1 x 1	1 pole - 2 x 2
Colour	Grey	Green/Yellow
Max. electric values (U _{max} , I _{max})	500 V, 24 A	-

Dimensions (mm)

	NSYTRP24D	NSYTRP24DPE
Length	78	78
Height	55	55
Width	5.2	5.2

	NSYTRP24D	NSYTRP24DPE
Cabling c.s.a. (mm ²)	2.5	2.5
Flexible cable	0.14 - 2.5	0.14 - 2.5
Solid cable	0.14 - 4	0.14 - 4

Nominal electric values

	NSYTRP24D	NSYTRP24DPE
IEC/EN 60947-7-1	500 V, 22 A	-
UL	600 V, 20 A, 26 - 12 AWG	26 - 12 AWG
CSA	600 V, 20 A, 26 - 12 AWG	26 - 12 AWG
ATEX	-	-

	NSYTRP24D	NSYTRP24DPE
Certifications (1)	UL, CSA, VDE, GL, LR, DNV, EAC	UL, CSA, VDE, GL, LR, DNV, EAC

Terminal blocks

	Sold in lots of	Unit reference	Sold in lots of	Unit reference
Grey	50	NSYTRP24D	50	NSYTRP24DPE
Blue	50	NSYTRP24DBL	-	-

Accessories

		Sold in lots of	Unit reference	Sold in lots of	Unit reference
1	End stop	50	NSYTRAAB35	50	NSYTRAAB35
2	for 35 mm DIN rail	50	NSYTRAABV35	50	NSYTRAABV35
3	End plate, width 2.2 mm	50	NSYTRACRE24	50	NSYTRACRE24
	Blue	-	-	-	-
5	Plug-in bridge	50	NSYTRAL22	50	NSYTRAL22
	Red	50	NSYTRAL23	50	NSYTRAL23
	4-pole	50	NSYTRAL24	50	NSYTRAL24
	5-pole	50	NSYTRAL25	50	NSYTRAL25
	10-pole	10	NSYTRAL210	10	NSYTRAL210
	20-pole	10	NSYTRAL220	10	NSYTRAL220
6	Vertical bridge 1-pole	50	NSYTRALV24R	-	-
8	Test plug	10	NSYTRAATM1	10	NSYTRAATM1
	Insulating sleeve, red	10	NSYTRAATP1	10	NSYTRAATP1
9	Test adaptor	10	NSYTRAFT	10	NSYTRAFT
11	Marker tag holder	100	NSYTRASB4	100	NSYTRASB4
12	DIN rail	20	NSYSR200BD	20	NSYSR200BD
	Perforated, 2 m long				
13	Marking accessories	See page 142			

General data

	NSYTRP24D	NSYTRP24DPE
Strip length (mm)	10	10

(1) ATEX and IECEx certifications pending.

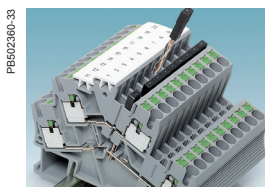
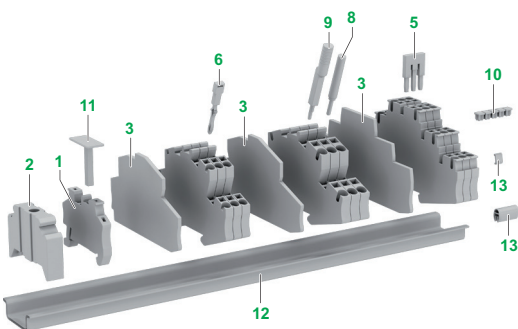

The NSYTRALV24R vertical bridge offers the option of connecting both levels of the standard double deck NSYTRP24D terminal block.

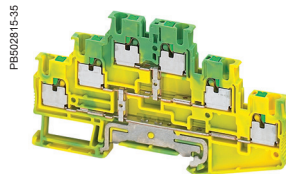
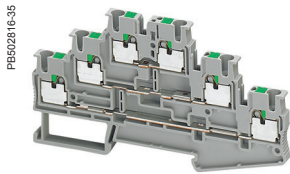

NSYTRP26T	NSYTRP26TPE
2.5 mm ²	2.5 mm ²
Passthrough - 3 Levels	Protective earth - 3 Levels
3 pole - 1 x 1	1 pole - 3 x 3
Grey	Green/Yellow
500 V, 24 A	-
102	102
58	58
5.2	5.2
2.5	2.5
0.14 - 2.5	0.14 - 2.5
0.14 - 4	0.14 - 4
500 V, 20 A	-
300 V, 20 A, 26 -12 AWG	26 -12 AWG
300 V, 20 A, 26 -12 AWG	-
-	-
UL, CSA, EAC	UL, EAC

Sold in lots of	Unit reference	Sold in lots of	Unit reference
50	NSYTRP26T	50	NSYTRP26TPE
50	NSYTRP26TBL	-	-
50	NSYTRAAB35	50	NSYTRAAB35
50	NSYTRAABV35	50	NSYTRAABV35
50	NSYTRACPE26	50	NSYTRACPE26
-	-	-	-
50	NSYTRAL22	50	NSYTRAL22
50	NSYTRAL23	50	NSYTRAL23
50	NSYTRAL24	50	NSYTRAL24
50	NSYTRAL25	50	NSYTRAL25
10	NSYTRAL210	10	NSYTRAL210
10	NSYTRAL220	10	NSYTRAL220
-	-	-	-
10	NSYTRAATM1	10	NSYTRAATM1
10	NSYTRAATP1	10	NSYTRAATP1
10	NSYTRAFT	10	NSYTRAFT
100	NSYTRASB4	100	NSYTRASB4
20	NSYS DR200BD	20	NSYS DR200BD

10	10
----	----

Push-in terminal blocks - Disconnect

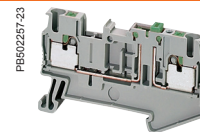

		NSYTRP22SC
Nominal c.s.a.		2.5 mm ²
	Type of block	Disconnect (blade)
	Type of connection	1 pole - 1 x 1
	Colour	Grey
Max. electric values (U _{max} , I _{max})		400 V, 20 A

Dimensions (mm)		
	Length	62
	Height	36.5
	Width	5.2
Cabling c.s.a. (mm ²)		2.5
	Flexible cable	0.14 - 2.5
	Solid cable	0.14 - 4

Nominal electric values		
	IEC/EN 60947-7-1	400 V, 20 A
	UL	300 V, 20 A, 26 -12 AWG
	CSA	300 V, 20 A, 26 -12 AWG
	ATEX Ⓜ	-

Certifications	UL, CSA, VDE, GL, LR, EAC
----------------	---------------------------

Terminal blocks			
	Grey	Sold in lots of	Unit reference
		50	NSYTRP22SC

Accessories				
1	End stop	Clip-on, 5.2 mm	50	NSYTRAAB35
2	for 35 mm DIN rail	With screw, 9.5 mm	50	NSYTRAABV35
3	End plate, width 2.2 mm	Grey	50	NSYTRACPK22
		Blue	-	-
4	Partition plate, width 2 mm	Grey	50	NSYTRAPR23
		Blue	-	-
5	Plug-in bridge Red	2-pole	50	NSYTRAL22
		3-pole	50	NSYTRAL23
		4-pole	50	NSYTRAL24
		5-pole	50	NSYTRAL25
		10-pole	10	NSYTRAL210
		20-pole	10	NSYTRAL220
14	Removable carrier width 6.1 mm	For fuse 5 x 20 mm	-	
		For fuse 5 x 20 mm 110 V	-	
		For fuse 5 x 20 mm 12 V	-	
15	Removable carrier width 5.1 mm	For component	-	
		With 1N4007 diode	-	
8	Test plug	Metallic part, Ø 2.3 mm	10	NSYTRAATM1
		Insulating sleeve, red	10	NSYTRAATP1
9	Test adaptor	For plug-in bridge shaft	10	NSYTRAFT
11	Marker tag holder	For ●AB35 end stop	100	NSYTRASB4
12	DIN rail 35 x 7.2 mm	Perforated, 2 m long	20	NSYSDR200BD
13	Marking accessories			See page 142

General data		
	Strip length (mm)	10

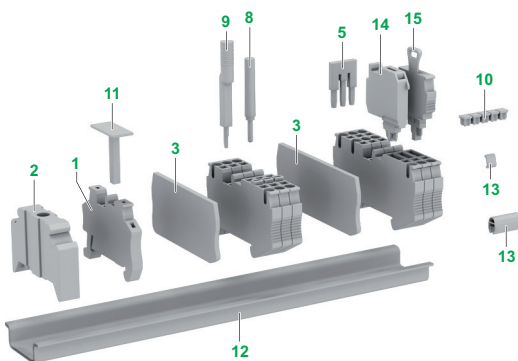

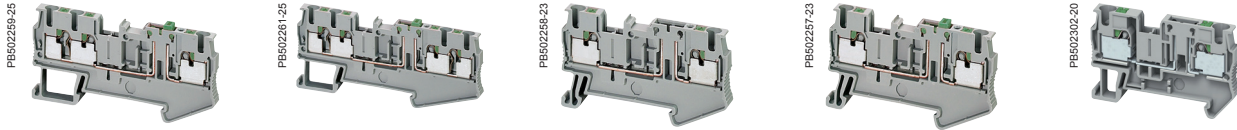

NSYTRP23SC	NSYTRP24SC	NSYTRP22TB	NSYTRP42SC	NSYTRP42TB
2.5 mm ²	2.5 mm ²	2.5 mm ²	4 mm ²	4 mm ²
Disconnect (blade)	Disconnect (blade)	Disconnect (for carrier)	Disconnect (blade)	Disconnect (for carrier)
1 pole - 1 x 2	1 pole - 2 x 2	1 pole - 1 x 1	1 pole - 1 x 1	1 pole - 1 x 1
Grey	Grey	Grey	Grey	Grey
400 V, 20 A	400 V, 20 A	400 V, 20 A	400 V, 20 A	400 V, 20 A
72	72	62	56	56
36.5	36.5	36.5	36.5	36.5
5.2	5.2	5.2	6.2	6.2
2.5	2.5	2.5	4	4
0.14 - 2.5	0.14 - 2.5	0.14 - 2.5	0.2 - 4	0.2 - 4
0.14 - 4	0.14 - 4	0.14 - 4	0.2 - 6	0.2 - 6
400 V, 20 A	400 V, 20 A	400 V, 20 A	400 V, 20 A	400 V, 20 A
300 V, 20 A, 26 -12 AWG	300 V, 20 A, 26 -12 AWG	300 V, 20 A, 26 -12 AWG	300 V, 20 A, 24 -12 AWG	300 V, 20 A, 24 -12 AWG
300 V, 20 A, 26 -12 AWG	300 V, 20 A, 26 -12 AWG	300 V, 20 A, 26 -12 AWG	300 V, 20 A, 24 -12 AWG	300 V, 20 A, 24 -12 AWG
-	-	-	-	-
UL, CSA, VDE, GL, LR, EAC	UL, CSA, VDE, GL, LR, EAC	UL, CSA, VDE, GL, LR, EAC	UL, CSA, EAC	UL, CSA, VDE, GL, EAC

Sold in lots of	Unit reference	Sold in lots of	Unit reference	Sold in lots of	Unit reference	Sold in lots of	Unit reference	Sold in lots of	Unit reference
50	NSYTRP23SC	50	NSYTRP24SC	50	NSYTRP22TB	50	NSYTRP42SC	50	NSYTRP42TB
50	NSYTRAAB35	50	NSYTRAAB35	50	NSYTRAAB35	50	NSYTRAAB35	50	NSYTRAAB35
50	NSYTRAABV35	50	NSYTRAABV35	50	NSYTRAABV35	50	NSYTRAABV35	50	NSYTRAABV35
50	NSYTRACPK23	50	NSYTRACPK24	50	NSYTRACPK22	50	NSYTRACR42	50	NSYTRACR42
-	-	-	-	-	-	-	-	-	-
50	NSYTRAPR24	-	-	-	-	50	NSYTRAPR24	50	NSYTRAPR24
-	-	-	-	-	-	-	-	-	-
50	NSYTRAL22	50	NSYTRAL22	50	NSYTRAL22	50	NSYTRAL42	50	NSYTRAL42
50	NSYTRAL23	50	NSYTRAL23	50	NSYTRAL23	50	NSYTRAL43	50	NSYTRAL43
50	NSYTRAL24	50	NSYTRAL24	50	NSYTRAL24	50	NSYTRAL44	50	NSYTRAL44
50	NSYTRAL25	50	NSYTRAL25	50	NSYTRAL25	50	NSYTRAL45	50	NSYTRAL45
10	NSYTRAL210	10	NSYTRAL210	10	NSYTRAL210	10	NSYTRAL410	10	NSYTRAL410
10	NSYTRAL220	10	NSYTRAL220	10	NSYTRAL220	10	NSYTRAL420	10	NSYTRAL420
-	-	-	-	10	NSYTRASF520	-	-	10	NSYTRASF520
-	-	-	-	10	NSYTRASF520M	-	-	10	NSYTRASF520M
-	-	-	-	10	NSYTRASF520B	-	-	10	NSYTRASF520B
-	-	-	-	10	NSYTRASV1	-	-	10	NSYTRASV1
-	-	-	-	10	NSYTRASV2	-	-	10	NSYTRASV2
10	NSYTRAATM1	10	NSYTRAATM1	10	NSYTRAATM1	10	NSYTRAATM1	10	NSYTRAATM1
10	NSYTRAATP1	10	NSYTRAATP1	10	NSYTRAATP1	10	NSYTRAATP1	10	NSYTRAATP1
10	NSYTRAFT	10	NSYTRAFT	10	NSYTRAFT	10	NSYTRAFT	10	NSYTRAFT
100	NSYTRASB4	100	NSYTRASB4	100	NSYTRASB4	100	NSYTRASB4	100	NSYTRASB4
20	NSYSDR200BD	20	NSYSDR200BD	20	NSYSDR200BD	20	NSYSDR200BD	20	NSYSDR200BD

10	10	10	10	10
----	----	----	----	----

Hybrid terminal blocks - Passthrough

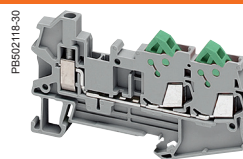
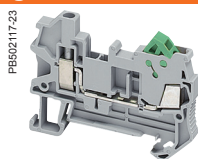

		NSYTRH12	NSYTRH13
Nominal c.s.a.		1.5 mm ²	1.5 mm ²
	Type of block	Passthrough	Passthrough
	Type of connection	1 pole - 1 x 1	1 pole - 1 x 2 (1 screw x 2 IDC)
	Colour	Grey	Grey
Max. electric values (U _{max} , I _{max})		800 V, 17 A	800 V, 17 A
Dimensions (mm)			
	Length	58.8	76.4
	Height	42.8	42.8
	Width	5.2	5.2
Cabling c.s.a. (mm ²)	IDC connection	1.5	1.5
	Flexible cable	0.5 - 1.5	0.5 - 1.5
Cabling c.s.a. (mm ²)	Screw connection	1.5	1.5
	Flexible cable	0.14 - 2.5	0.14 - 2.5
	Solid cable	0.14 - 4	0.14 - 4
Nominal electric values			
	IEC/EN 60947-7-1	800 V, 17 A	800 V, 17 A
	UL	600 V, 10 A, 24 - 16 AWG	600 V, 10 A, 24 - 16 AWG
	CSA	600 V, 10 A, 24 - 16 AWG	600 V, 10 A, 24 - 16 AWG
	ATEX Ⓜ	550 V, 16.5 A	550 V, 16.5 A
Certifications		UL, CSA, ATEX, IECEx, EAC	UL, CSA, ATEX, IECEx, EAC

Terminal blocks



	Sold in lots of	Unit reference	Sold in lots of	Unit reference
Grey	50	NSYTRH12	50	NSYTRH13

Accessories

End stop for 35 mm DIN rail	Clip-on, 5.2 mm	50	NSYTRAAB35	50	NSYTRAAB35
	With screw, 9.5 mm	50	NSYTRAABV35	50	NSYTRAABV35
End plate, width 2.2 mm	Grey	50	NSYTRACH12	50	NSYTRACH13
	Blue	-	-	-	-
Partition plate, width 2 mm	Grey	50	NSYTRAPD12	50	NSYTRAPD13
	Blue	-	-	-	-
Plug-in bridge Red	2-pole	50	NSYTRAL22	50	NSYTRAL22
	3-pole	50	NSYTRAL23	50	NSYTRAL23
	4-pole	50	NSYTRAL24	50	NSYTRAL24
	5-pole	50	NSYTRAL25	50	NSYTRAL25
	10-pole	10	NSYTRAL210	10	NSYTRAL210
	20-pole	10	NSYTRAL220	10	NSYTRAL220
Test plug	Metalic part, Ø 2.3 mm	10	NSYTRAATM1	10	NSYTRAATM1
	Insulating sleeve, red	10	NSYTRAATP1	10	NSYTRAATP1
Test adaptor	For plug-in bridge shaft	10	NSYTRAFT	10	NSYTRAFT
Marker tag holder	For ●AB35 end stop	100	NSYTRASB4	100	NSYTRASB4
DIN rail 35 x 7.2 mm	Perforated, 2 m long	20	NSYSDR200BD	20	NSYSDR200BD

Marking accessories See page 142

General data

Strip length (mm)	9	9
Screw thread	M3	M3
Torque (Nm)	0.5 - 0.6	0.6 - 0.8

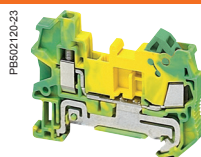
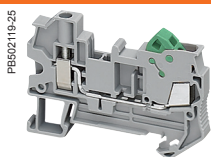

NSYTRH22		NSYTRH12PE	
2.5 mm ²		1.5 mm ²	
Passthrough		Protective earth	
1 pole - 1 x 1		1 pole - 1 x 1	
Grey		Green/Yellow	
800 V, 24 A		-	
62.6		58.8	
42.8		42.8	
6.2		5.2	
2.5		1.5	
0.5 - 2.5		0.5 - 1.5	
2.5		1.5	
0.14 - 4		0.14 - 2.5	
0.14 - 6		0.14 - 4	
800 V, 24 A		-	
600 V, 15 A, 20 - 14 AWG		24 - 16 AWG	
600 V, 15 A, 20 - 14 AWG		24 - 16 AWG	
550 V, 22 A		-	
UL, CSA, ATEX, IECEx, EAC		UL, CSA, ATEX, IECEx, EAC	
Sold in lots of	Unit reference	Sold in lots of	Unit reference
50	NSYTRH22	50	NSYTRH12PE
50	NSYTRAAB35	50	NSYTRAAB35
50	NSYTRAABV35	50	NSYTRAABV35
50	NSYTRACH22	50	NSYTRACH12
-	-	-	-
-	-	50	NSYTRAPD12
-	-	-	-
50	NSYTRAL42	50	NSYTRAL22
50	NSYTRAL43	50	NSYTRAL23
50	NSYTRAL44	50	NSYTRAL24
50	NSYTRAL45	50	NSYTRAL25
10	NSYTRAL410	10	NSYTRAL210
10	NSYTRAL420	10	NSYTRAL220
10	NSYTRAATM1	10	NSYTRAATM1
10	NSYTRAATP1	10	NSYTRAATP1
10	NSYTRAFT	10	NSYTRAFT
100	NSYTRASB4	100	NSYTRASB4
20	NSYSDR200BD	20	NSYSDR200BD
10		14	
M4		M5	
1.5 - 1.8		2.5 - 3	

Accessories

PB502169-18



PB502210-18



PB502202-36



PB502202-36



Test accessories	NSYTRAFT	NSYTRAFT●●	NSYTRAATM1	NSYTRAATP1
Description	Test adapter for Ø 4 mm test plugs	Snap-on test adapter for Ø 4 mm test plugs	Test adapter - metallic part Ø 2.3 mm	Test adapter - plastic part Ø 2.3 mm
Dimensions W / D / H (mm)	6 / 6.5 / 51 mm	6 / 6.5 / 51 mm	5 / 5 / 10.8 mm	5 / 5 / 20 mm
Material	Polyamide (PA 6.6)	Polyamide (PA 6.6)	Silver-plated brass	Polyamide (PA 6.6)
Colour	Grey	Orange / Yellow / Green	Silver	Red
Inflammability class acc. to UL 94	V0	V0	-	V0
Temperature range (°C)	-40 ... +125	-40 ... +125	-40 ... +125	-40 ... +125
Compatibility	For 2.5 mm ² , 4 mm ² & 6 mm ² terminals	For 6 mm ² terminals	For 2.5 mm ² , 4 mm ² & 6 mm ² terminals	-
For terminal block width	5.2 mm; 6.2 mm & 8.2 mm	8.2 mm	5.2 mm; 6.2 mm & 8.2 mm	-
Mounting position	Plugs in bridge shafts	Plugs in bridge shafts Cannot be removed	Plugs in bridge shafts For 2.3 mm Ø socket hole	For NSYTRAATM1 metal part

Marking strips

Color	Grey	Sold in lots of	Unit Reference	Sold in lots of	Unit Reference	Sold in lots of	Unit Reference	Sold in lots of	Unit Reference
Color	Grey	10	NSYTRAFT	-	-	10	NSYTRAATM1	-	-
	Orange	-	-	10	NSYTRAFTAR	-	-	-	-
	Yellow	-	-	10	NSYTRAFTYE	-	-	-	-
	Green	-	-	10	NSYTRAFTGN	-	-	-	-
	Red	-	-	-	-	-	-	10	NSYTRAATP1

Accessories

PB502123-20



PB502124-20



PB502122-18



Insulation accessories	NSYTRAAB35	NSYTRAABV35	NSYTRAAB15
Description	End stop, clip-on	End stop, with screw	End stop, clip-on
Dimensions W / D / H (mm)	5.2 / 48.5 / 35	9.5 / 48.6 / 32.8	5.2 / 22 / 22.6 mm
Material	Polyamide (PA)	Polyamide (PA)	Polyamide (PA)
Colour	Grey	Grey	Grey
Inflammability class acc. to UL 94	V2	V2	V2
Temperature range (°C)	-40 ... +100	-40 ... +100	-40 ... +100
Compatibility	For NS 35/7.5 or NS 35/15 DIN rail	For NS 35/7.5 or NS 35/15 DIN rail	For NS 15 DIN rail
For terminal block width	-	-	-
Mounting position	Markable with NSYTRABF5● strips	Markable with NSYTRAB8● strips	Markable with NSYTRABF5● strips

Marking strips

Color	Grey	Sold in lots of	Unit Reference	Sold in lots of	Unit Reference	Sold in lots of	Unit Reference
Color	Grey	50	NSYTRAAB35	50	NSYTRAABV35	50	NSYTRAAB15
	Orange	-	-	-	-	-	-
	Yellow	-	-	-	-	-	-



NSYTRAF2 / 4 / 6	NSYTRAPT16 / 35	NSYTRASV●	NSYTRASF520●
Modular test plug with 1.5 mm ² spring cage connection	Pick-off terminal blocks. For connecting 2.5 mm ² cables to 16 & 35 mm ² terminals	Removable component carrier - with spring cage contact - 6 A max	Removable fuse carrier For fuse 5 x 20 mm - 6 A max
5.2 (6.2; 8.2) / 22.4 / 60 mm	8.2 / 20.7 / 34.7	5.1 / 24 / 22 mm	6.1 / 28 / 25 mm
Polyamide (PA 6.6)	Polyamide (PA 6.6)	Polyamide (PA 6.6)	Polyamide (PA 6.6)
Red	Grey	Grey	Black
V0	V0	V0	V0
-40 ... +125	-40 ... +125	-40 ... +125	-40 ... +125
NSYTRAF2 - for 2.5 mm ² terminals NSYTRAF4 - for 4 mm ² terminals NSYTRAF6 - for 6 mm ² terminals	For 16 mm ² & 35 mm ² terminals In = 32 A	For all disconnect terminals	For 4 mm ² disconnect terminals Only for individual 2.5 mm ² disconnect terminals
NSYTRAF2 - 5.2 mm NSYTRAF4 - 6.2 mm NSYTRAF6 - 8.2 mm	12.2 mm & 16 mm	5.2 mm & 6.2 mm	6.2 mm (& 5.2 mm)
Plugs in bridge shafts Markable with NSYTRABF●● strips	Snapp-in the lateral guide of the terminal Markable with NSYTRAB10● strips	Plugs in the disconnect area Markable with NSYTRABF5● strips	Plugs in the disconnect area Markable with NSYTRAB6● strips Only for single 5.2 mm terminal blocks

Sold in lots of	Unit Reference	Sold in lots of	Unit Reference	Sold in lots of	Unit Reference	Sold in lots of	Unit Reference
-	-	10	NSYTRAPT16	10	NSYTRASV1 for component	10	NSYTRASF520
-	-	10	NSYTRAPT35	10	NSYTRASV2 with 1N4007 diode	10	NSYTRASF520M with LED 110-250V
-	-	-	-	-	-	10	NSYTRASF520B with LED 11-30 V
-	-	-	-	-	-	-	-
-	-	-	-	-	-	-	-
10	NSYTRAF2	-	-	-	-	-	-
10	NSYTRAF4	-	-	-	-	-	-
10	NSYTRAF6	-	-	-	-	-	-



NSYTRACS●	NSYTRACSR●	NSYTRASB4
Warning label for screw terminals	Warning cover for spring and push-in terminals	Terminal strip marker carrier, height-adjustable
-	-	10 / 22 / 27
Polyamide	Polyamide	Polyamide
Yellow	Yellow	Grey
V0	V2	V2
-40 ... +125	-40 ... +100	-40 ... +100
Only for screw terminal from 2.5 mm ² upto 35 mm ²	Only for spring or push-in terminal from 2.5 mm ² upto 35 mm ²	For NSYTRAAB35 , NSYTRAABV35 & NSYTRAAB15 end stop
5.2 / 6.2 / 8.2 / 10.2 / 12 / 16 mm	5.2 / 6.2 / 8.2 / 10.2 / 12 / 16 mm	-
The warning label snap into the screw shafts of the relevant terminal	The warning cover snap into the actuation shafts of the relevant terminal	Snap into the shaft of the end stop Markable with LA9D91 or LA9D93 labels

Sold in lots of	Unit Reference	Sold in lots of	Unit Reference	Sold in lots of	Unit Reference
-	-	-	-	100	NSYTRASB4
-	-	-	-	-	-
10	NSYTRACS2	10	NSYTRACSR2	-	-
10	NSYTRACS4	10	NSYTRACSR4	-	-
10	NSYTRACS6	10	NSYTRACSR6	-	-
10	NSYTRACS10	10	NSYTRACSR10	-	-
10	NSYTRACS16	-	-	-	-
10	NSYTRACS35	-	-	-	-

Marking accessories



Clip-in marker strips	NSYTRAB5●	NSYTRAB6●	NSYTRAB8●
Description	10 consecutive figures or numbers, printed horizontally	10 consecutive figures or numbers, printed horizontally	10 consecutive figures or numbers, printed horizontally
Material	Polyamide (PA 6.6, silicone and halogen free)	Polyamide (PA 6.6, silicone and halogen free)	Polyamide (PA 6.6, silicone and halogen free)
Colour	Black markings on white background	Black markings on white background	Black markings on white background
Inflammability class acc. to UL 94	V2	V2	V2
Temperature range (°C)	-40 ... +100	-40 ... +100	-40 ... +100
Compatibility	For all 2,5 mm ² terminal blocks For 10 mm ² TBs: 2 marking elements for 1 terminal	For all 4 mm ² terminal blocks For 16 mm ² TBs: 2 marking elements for 1 terminal	For 6 mm ² TBs: NSY TRV / TRR For 35 mm ² TBs: 2 marking elements for 1 terminal
For terminal block width	5.2 mm	6.2 mm	8.2 mm
Mounting position	Lateral sides for NSYTRV terminal blocks Central shaft for NSYTRR / NSYTRP / NSYTRH terminal blocks	Lateral sides for NSYTRV terminal blocks Central shaft for NSYTRR / NSYTRP / NSYTRH terminal blocks	Lateral sides for NSYTRV terminal blocks Central shaft for NSYTRR / NSYTRP terminal blocks

Marking strips

Printed characters	Sold in lots of	Unit reference	Sold in lots of	Unit reference	Sold in lots of	Unit reference
1 ... 10	10	NSYTRAB510	10	NSYTRAB610	10	NSYTRAB810
11 ... 20	10	NSYTRAB520	10	NSYTRAB620	10	NSYTRAB820
21 ... 30	10	NSYTRAB530	10	NSYTRAB630	10	NSYTRAB830
31 ... 40	10	NSYTRAB540	10	NSYTRAB640	10	NSYTRAB840
41 ... 50	10	NSYTRAB550	10	NSYTRAB650	10	NSYTRAB850
51 ... 60	10	NSYTRAB560	10	NSYTRAB660	10	NSYTRAB860
61 ... 70	10	NSYTRAB570	10	NSYTRAB670	10	NSYTRAB870
71 ... 80	10	NSYTRAB580	10	NSYTRAB680	10	NSYTRAB880
81 ... 90	10	NSYTRAB590	10	NSYTRAB690	10	NSYTRAB890
91 ... 100	10	NSYTRAB5100	10	NSYTRAB6100	10	NSYTRAB8100
1 ... 100 (1 - 10; 11 -20; ... 91 - 100)	100	NSYTRAB51100	100	NSYTRAB61100	-	-
L1, L2, L3, N, PE, L1, L2, L3, N, PE	10	NSYTRAB5L1N	10	NSYTRAB6L1N	-	-
Letters (A to Z)	-	-	-	-	-	-
Numbers (0 to 9)	-	-	-	-	-	-

Marking cards



Blank marking cards	Sold in lots of	Unit reference	Sold in lots of	Unit reference	Sold in lots of	Unit reference
72 characters (6 strips)	10	NSYTRABPV5	-	-	-	-
60 characters (6 strips)	-	-	10	NSYTRABPV6	-	-
42 characters (6 strips)	-	-	-	-	10	NSYTRABPV8

Marking cards for AB1/DB6 terminals and Multi9 Acti9 range (2)

Blank (60 characters max.)	-	-	10	NSYTRAXPV6	-	-
1 ... 10 (6 strips)	-	-	10	NSYTRAXP610	-	-
11 ... 20 (6 strips)	-	-	10	NSYTRAXP620	-	-
21 ... 30 (6 strips)	-	-	10	NSYTRAXP630	-	-
31 ... 40 (6 strips)	-	-	10	NSYTRAXP640	-	-
41 ... 50 (6 strips)	-	-	10	NSYTRAXP650	-	-
L1, L2, L3 (60 characters max.)	-	-	10	NSYTRAX6L1L3	-	-

Accessories

Plotter adapter for marking cards	1	NSYTRABMP1	1	NSYTRABMP1	1	NSYTRABMP1
-----------------------------------	---	------------	---	------------	---	------------

(1) For 16mm² terminal blocks or bigger, the strip must be broken and use the individual marking characters.

(2) Only for AB1 terminal blocks 4mm²; and for Multi9 Acti9 range. Can't be used in NSYTR terminals.

(3) Complete the reference by replacing the dot with the required letter. Each lot includes 10 strips with 10 letters each.

(4) Complete the reference by replacing the dot with the required number. Each lot includes 10 strips with 10 numbers each.

PB602340-16



PB602350-20



NSYTRAB10●	NSYTRABF5●	NSYTRABF6●
10 consecutive figures or numbers, printed horizontally	10 consecutive figures or numbers, printed horizontally	10 consecutive figures or numbers, printed horizontally
Polyamide (PA 6.6, silicone and halogen free)	Polyamide (PA 6.6, silicone and halogen free)	Polyamide (PA 6.6, silicone and halogen free)
Black markings on white background	Black markings on white background	Black markings on white background
V2	V2	V2
-40 ... +100	-40 ... +100	-40 ... +100
For $\geq 10 \text{ mm}^2$ TBs: NSY TRV / TRR	For all $2,5 \text{ mm}^2$ terminal blocks For 10 mm^2 TBs: 2 marking elements for 1 terminal.	For all 4 mm^2 terminal blocks For 16 mm^2 TBs: 2 marking elements for 1 terminal.
$\geq 10.2 \text{ mm}$ (1)	5.2 mm	6.2 mm
Lateral sides for NSYTRV terminal blocks Central shaft for NSYTRR / NSYTRP terminal blocks	Lateral sides for all NSYTR terminal blocks	Lateral sides for all NSYTR terminal blocks

Sold in lots of	Unit reference	Sold in lots of	Unit reference	Sold in lots of	Unit reference
10	NSYTRAB1010	10	NSYTRABF510	10	NSYTRABF610
10	NSYTRAB1020	10	NSYTRABF520	10	NSYTRABF620
10	NSYTRAB1030	10	NSYTRABF530	10	NSYTRABF630
10	NSYTRAB1040	10	NSYTRABF540	10	NSYTRABF640
10	NSYTRAB1050	10	NSYTRABF550	10	NSYTRABF650
10	NSYTRAB1060	-	-	-	-
10	NSYTRAB1070	-	-	-	-
10	NSYTRAB1080	-	-	-	-
10	NSYTRAB1090	-	-	-	-
10	NSYTRAB10100	-	-	-	-
-	-	-	-	-	-
-	-	-	-	-	-
-	-	10	NSYTRABF5● (3)	-	-
-	-	10	NSYTRABF5● (4)	10	NSYTRABF6● (4)

PB602341-26



PB602342-26



Sold in lots of	Unit reference	Sold in lots of	Unit reference	Sold in lots of	Unit reference
-	-	10	NSYTRABFPV5	-	-
-	-	-	-	10	NSYTRABFPV6
-	-	-	-	10	NSYTRABFPV8 (3)
-	-	-	-	-	-
-	-	-	-	-	-
-	-	-	-	-	-
-	-	-	-	-	-
-	-	-	-	-	-
-	-	-	-	-	-
-	-	-	-	-	-
-	-	-	-	-	-
-	-	-	-	-	-
-	-	-	-	-	-
-	-	1	NSYTRABMP2	1	NSYTRABMP2

Marking accessories

PB602201-20



		NSYTRABCV●
		Marking collars for cables
Description		Open marker carrier, 15 mm wide, for clipping into wire
	Material	PVC (Siliconefree)
	Colour	White marker with transparent sleeve
	Inflammability class according to UL 94	V0
	Temperature range [°C]	-50 ... +80
Compatibility		For conductor diameter 2 mm up to 8 mm
	Mounting position	Clip-on to the cable
	Marking elements	With any of the NSYTRABCP● marking elements

Marking collars and inserts

Marking collars		Sold in lots of	Unit reference
for conductor diameter	2 to 3.5 mm	500	NSYTRABCV23
	3 to 5 mm	500	NSYTRABCV35
	5 to 8 mm	500	NSYTRABCV58

Marking inserts, A4 format, perforated

Colour	White	-	-
	Yellow	-	-
	Red	-	-
	Blue	-	-

Marking card with 50 inserts

Colour	White	-	-
--------	-------	---	---

Marking accessories

PB602351-30

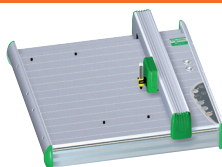

		NSYTRAPLOT
		Plotter
		<ul style="list-style-type: none"> ■ A flexible plotter that helps you label marking elements quickly and easily. ■ Rugged construction in stylish aluminium ■ Easy to change fixtures to suit a variety of marking elements ■ Auto calibration no adjustment necessary ■ Including NSYTRA BMP1 / BMP2 adaptor plates, 0.25 & 0.35 mm black pens, Spacial.print software, power supply, connecting cables, user manual
Printing area		A4
Input voltage/ frequency		100 - 240 V AC, 50/60 Hz
Interface		USB 2.0
Operating system		MS Windows XP/Vista/7
Compatibility		For all NSYTR blank marking cards

Marking collars and inserts

Marking plotter		Sold in lots of	Unit reference
Colour	Grey	1	NSYTRAPLOT

Accessories

		Sold in lots of	Unit reference
Adaptor plates	For NSYTRABPV● ; NSYTRAXPV* and NSYTRABCP5 marking cards	1	NSYTRABMP1
	For NSYTRAFBPV● marking cards	1	NSYTRABMP2
	For ZBY● marking elements ¹	1	NSYTRABMP3
Pen, disposable	0.18 mm line, black	1	NSYTRAPEN1
	0.25 mm line, black	1	NSYTRAPEN2
	0.35 mm line, black	1	NSYTRAPEN3

(1) Can print **ZBY0102**; **ZBY0501** and **ZBY0502** marking elements and all marking sheets: **NSYTRABCV●**; **ZBY4100**; **ZBY001**; **ZBY5100** and **ZBY1101**.

PB602362-28



NSYTRABC

Marking inserts for collars

360 inserts for marking collars, A4 format, perforated 15 x 4 mm inserts

Polyester (Silicone and halogen free)

White, yellow, red or blue

V0

40 ... +100

For all **NSYTRABC** marking collars

Slides inside the collar sleeve

Can be printed with any office printer, plotter or pen

PB602201-32



NSYTRABCP5

Marking card for collars

Marking card with 50 inserts for marking collars 15 x 4 mm inserts

Polycarbonate

White

V0

-40 ... +120

For all **NSYTRABC** marking collars

Slides inside the collar sleeve

Can be printed with plotter or pen

Sold in lots of

Unit reference

-

-

-

-

-

-

10

NSYTRABCP1

10

NSYTRABCP2

10

NSYTRABCP3

10

NSYTRABCP4

Sold in lots of

Unit reference

-

-

-

-

-

-

10

NSYTRABCP5

Marking accessories

PB602630-22



PB602631-25



PB602632-30

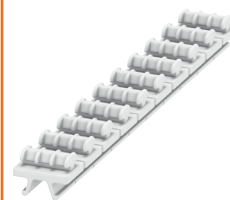

Marking adaptors

Description

NSYTRABB5
Adaptor for AB1R marking elements.
Can adapt maximum 3 AB1R elements on a NSYTR terminal

NSYTRABB6
Adaptor for AB1R marking elements.
Can adapt maximum 3 AB1R elements on a NSYTR terminal

NSYTRABB8
Adaptor for AB1R marking elements.
Can adapt maximum 3 AB1R elements on a NSYTR terminal

Material

Polyamide

Polyamide

Polyamide

Colour

White

White

White

Inflammability class acc. to UL 94

V2

V2

V2

Temperature range (°C)

-40 ... +100

-40 ... +100

-40 ... +100

Compatibility

For terminal block width

For 2.5 mm² TBs: **NSY TRV / TRR / TRP / TRH**

For 4 mm² TBs: **NSY TRV / TRR / TRP / TRH**

For 6 mm² TBs: **NSY TRV / TRR / TRP / TRH**

Mounting position

Lateral sides for **NSYTRV** terminal blocks
Central shaft for **NSYTRR / NSYTRP / NSYTRH** terminal blocks

Lateral sides for **NSYTRV** terminal blocks
Central shaft for **NSYTRR / NSYTRP / NSYTRH** terminal blocks

Lateral sides for **NSYTRV** terminal blocks
Central shaft for **NSYTRR / NSYTRP / NSYTRH** terminal blocks

Marking strips

Sold in lots of

Unit reference

10

NSYTRABB5

Sold in lots of

Unit reference

10

NSYTRABB6

Sold in lots of

Unit reference

10

NSYTRABB8

Strips of clip-in markers for NSYTRABB5/6/8 adapters (1) (2) (3)

816254		816255		816256		816257	
AB1 R●●		AB1 R11		AB1 G●		AB1 G●	
10 identical numbers (or symbols)		10 numbers 0 to 9		10 identical capital letters		10 identical capital letters	
Sold in lots of 25 identical strips		25 identical strips		25 identical strips		25 identical strips	
Marking	Unit reference	Marking	Unit reference	Marking	Unit reference	Marking	Unit reference
Blank	AB1 RV	0...9	AB1 R11	A	AB1 GA	N	AB1 GN
1	AB1 R1			B	AB1 GB	O	AB1 GO
2	AB1 R2			C	AB1 GC	P	AB1 GP
3	AB1 R3			D	AB1 GD	Q	AB1 GQ
4	AB1 R4			E	AB1 GE	R	AB1 GR
5	AB1 R5			F	AB1 GF	S	AB1 GS
6	AB1 R6			G	AB1 GG	T	AB1 GT
7	AB1 R7			H	AB1 GH	U	AB1 GU
8	AB1 R8			I	AB1 GI	V	AB1 GV
9	AB1 R9			J	AB1 GJ	W	AB1 GW
0	AB1 R0			K	AB1 GK	X	AB1 GX
+	AB1 R12			L	AB1 GL	Y	AB1 GY
-	AB1 R13			M	AB1 GM	Z	AB1 GZ

Marking components (1) (2)

816259		816258		816260		816261		816262	
AB1 SR6		AB1 SA●		AB1 RT		AR1 SB2		AR1 SB3	
Holder for 6 markers (Holder for up to 6 AB1 R or G markers)		Blank clip-on marker		Clip-on marker with earth symbol \perp (4)		Marker holder for screw fixing to any type of support		Adhesive marker holder for fixing to any type of support	
Sold in lots of 200		500		500		100		50	
Size mm	Unit reference	Size mm	Unit reference	Size mm	Unit reference	Size mm	Unit reference	Size mm	Unit reference
5 x 19	AB1SR6	4.5 x 8.3	AB1 SA1	4.5 x 8.3	AB1 RT	20 x 20	AR1 SB2	20 x 10	AR1 SB3
		4.5 x 14	AB1 SA2						
		4.5 x 19	AB1 SA3						

(1) Can NOT be mounted directly on NSYTR* terminal blocks, need to use the NSYTRABB* adapters!

(2) For Schneider Electric products such as thermal-magnetic circuit-breakers, modular contactors, model D and model E contactors, interfaces. Can also be used with terminal blocks type NSYTR* in association with NSYTRABB* adapters.

(3) Dimensions of clip-in markers on the strips: 4.5 mm x 2.7 mm.

(4) Black on white background.



DD381516-LIN

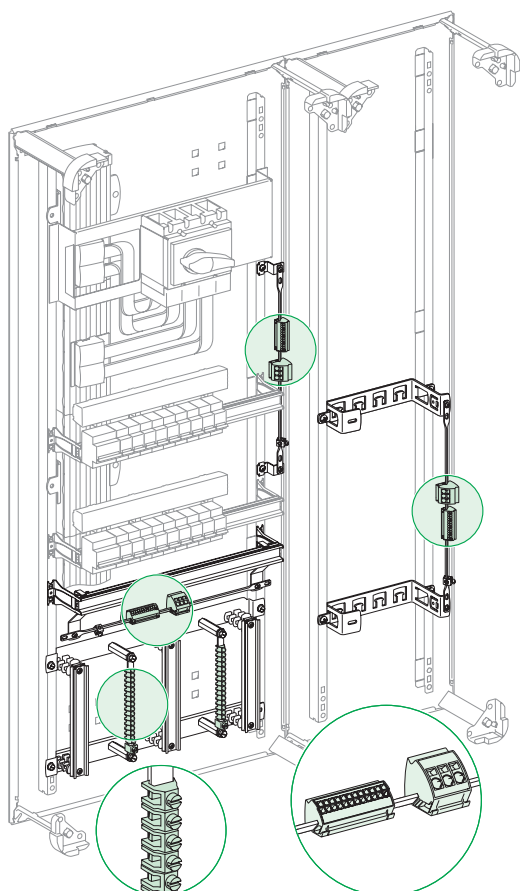

Description

This range of earth bars is installed:

- in the duct which can constitute a dedicated area, completely separate from the equipment
- or in the switchgear compartment, at the top or the bottom

Fast-connecting earth bar

DD381516-LIN

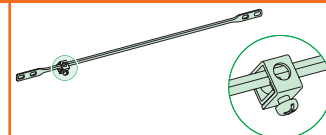

Copper earth bar

Cross-section (mm)	12 x 3
Effective length (mm)	330
Total length (mm)	450
Composition	Copper bar with 1 terminal 16 to 35 mm ²
References	04201

Accessories

DD381516-LIN

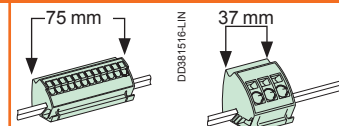

Earth blocks with terminals

Spring-fixing (clip onto the earth bar)

Total connection capacity	12 x 4 mm ²	3 x 16 mm ²
Composition	4 earth blocks	4 earth blocks
References	04214	04215

Accessories

DD381516-LIN

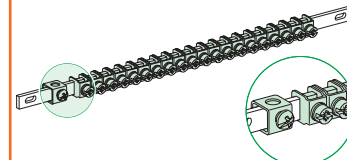

Earth bar with jumper

Total connection capacity	40 x 2.5 to 16 mm ²	20 x 2.5 to 16 mm ²
Cross-section (mm)	12 x 13	12 x 13
Length (mm)	450	200
Composition	40 jumpers and a terminal (16 to 35 mm ²)	20 jumpers and a terminal (16 to 35 mm ²)
References	04200	04202

Accessories

DD381516-LIN

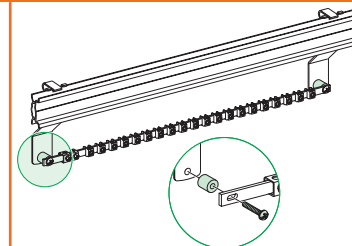

Neutral bar

Converts an earth bar to a neutral bar

Composition	2 insulating spacers
References	04210

PE conductors

	Vertical PE conductor with Linergy LGY profile (W = 1670 mm)	Vertical PE conductor with Linergy BS busbar (W = 1675 mm)	Horizontal PE conductor with Linergy BS busbar
Rated short-time current (I _{cw})	≤ 40	> 40	≤ 40
Permissible current (A)	630	800	
Cross-section (mm)		25 x 5	50 x 5
References	04502	04503	04512

Support selection

Composition	Three supports for a vertical PE (supplied with PE marking), to be screwed onto the framework	Three supports for a vertical PE (supplied with PE marking), to be screwed onto the framework	Two supports for a horizontal PE
References	04657	04657	04667

Connection between PE conductors

	Connection plates for horizontal/vertical PE bars	Linergy connection hardware
Composition	2	20 M8 screws (W = 25 mm) + 20 nuts + 20 contact washers for connection to cable lugs or flexible bars
References	04672	04766

DD381644-LIN

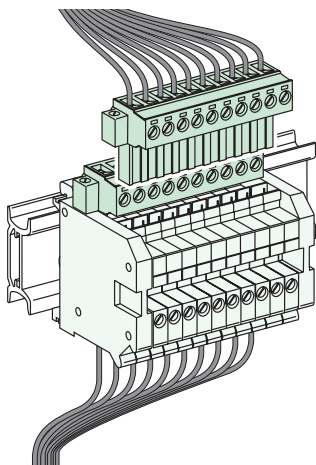

Description

For distributing auxiliary voltages in power and regulation equipment.

Terminal block for auxiliary wiring

DD381644-LIN

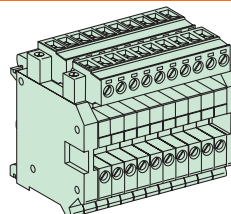

Standards		IEC	UL
Rated operational current at 40° (Ie)		12 A	20 A
Rated operational voltage (Ue)		250 V	300 V
Rated impulse withstand voltage (Uimp)		4 kV	
Connection capacity	Input	10 (grey)	
	Output	2 x 10 (grey)	
Dimensions (HxWxD)	(mm)	61 x 48 x 45	
Cross-section		0.2 to 4 mm	
Tightening torque		0.5 to 0.6 Nm	
Composition		3.5 18-mm modules	
References		04228	

Four-pole auxiliary bus duct

DD381602-LIN

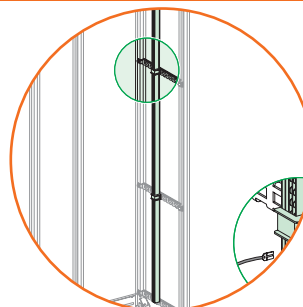

		Duct for 4 conductors	
		166 tap-off points with Faston connectors, per linear meter	
Rated operational current at 40° (Ie)		32 A	
Rated insulation voltage (Ui)		660 V	
Length (mm)		1755	
Composition		Supplied with 2 end clamps and 1 lateral clamp for mounting on cable-tie supports	
References		04203	



Reference	Page(s)	Reference	Page(s)	Reference	Page(s)	Reference	Page(s)
01...		04147	51	04607	54	14909	33
01109	53, 56	04148	51	04620	58	14910	33
01201	50	04150	50	04621	58	14911	33
01202	25	04151	50	04623	58	19...	
01210	50	04152	50	04624	58	19512	29
01211	50	04155	20	04634	53	21...	
03...		04156	20	04635	53, 56, 57	21089	29
03416	36	04158	50	04636	53, 55, 56, 57	21093	29
03420	34	04161	46, 47	04637	55	021094	29
03421	34	04162	46, 47	04638	55	021095	29
03422	34	04163	46, 47	04640	59	021096	29
03802	34	04171	46, 47	04641	59	021098	29
03803	34	04172	46, 47	04642	53, 55, 56, 57	21501	29
03812	34	04173	46, 47	04643	59	21503	29
03813	34	04174	47	04646	54, 58	21505	29
03851	34	04191	46	04651	53	21507	29
03853	34	04192	47	04652	56	A9...	
04...		04194	49	04653	57	A9N21035	30
04000	25	04195	49	04657	149	A9N21036	30
04008	25	04197	47	04658	54	A9N21037	30
04012	25	04198	46	04659	54	A9N21038	30
04013	25	04200	148	04661	54, 55	A9N21039	30
04014	25	04201	148	04662	54, 55, 57, 58, 59	A9N21040	30
04018	25	04202	148	04663	54, 55	A9N21041	30
04021	25, 50, 51	04203	150	04664	58, 59	A9N21042	30
04024	25	04210	148	04666	54, 55	A9N21050	30
04026	25	04214	148	04667	149	A9XAH157	27
04029	25	04215	148	04669	57	A9XAH257	27
04030	25	04228	150	04671	54, 58, 59	A9XAH357	27
04031	18	04403	34	04672	149	A9XAH457	27
04033	20	04404	34	04678	55, 59	A9XAH557	27
04034	20	04405	34	04766	53, 56, 149	A9XAH657	27
04037	18	04406	34	04767	53, 56	A9XPCD04	27, 28
04038	21	04407	34	04772	53, 56	A9XPCM04	27, 28
04039	21	04408	34	04773	53, 56	A9XPE110	27
04040	18	04410	36	04774	53, 56	A9XPE210	27
04041	18	04411	36	04775	53, 56	A9XPE310	27
04045	18	04412	36	04794	53, 56	A9XPE410	27
04046	18	04413	36	04809	35	A9XPH106	27
04047	18	04416	36	04810	37	A9XPH112	27
04052	48	04417	36	07...		A9XPH124	27
04053	48	04418	36	07051	49	A9XPH157	27
04054	48	04419	36	07052	49	A9XPH212	27
04055	48	04420	36	07053	49	A9XPH224	27
04060	51	04502	53, 56, 149	09...		A9XPH257	27
04061	51	04503	53, 56, 149	09516	29	A9XPH312	27
04062	51	04504	53, 56	10...		A9XPH324	27
04064	51	04505	53, 56	10387	31	A9XPH357	27
04070	51	04506	53, 56	10388	31	A9XPH412	27
04071	51	04512	149	10389	31	A9XPH424	27
04073	51	04515	149	10390	31	A9XPH457	27
04074	51	04516	55, 57	10391	31	A9XPH512	27
04103	50	04518	55, 57	10392	31	A9XPH518	27
04104	50	04525	55, 57	10393	31	A9XPH524	27
04107	50	04526	55, 57	10394	31	A9XPH557	27
04108	50	04528	55, 57	10395	31	A9XPM112	28
04111	50	04536	59	10396	31	A9XPM212	28
04112	50	04538	59	10397	31	A9XPM312	28
04113	50	04545	59	10398	31	A9XPM412	28
04114	50	04546	59	10399	31	A9XPM512	28
04116	50	04548	59	010405	29, 31	A9XPT920	27, 28
04117	50	04550	59	10545	29	AB...	
04118	50	04552	59	10546	29	AB1 GA	146
04119	50	04560	54, 58	10547	29	AB1 GB	146
04121	50	04561	54, 58	14...		AB1 GC	146
04122	50	04562	54, 58	14811	26	AB1 GD	146
04123	50	04563	54, 58	14812	26	AB1 GE	146
04124	50	04564	54, 58	14813	26	AB1 GF	146
04126	50	04565	54, 58	14814	26	AB1 GG	146
04127	50	04566	54, 58	14818	26	AB1 GH	146
04128	50	04567	54, 58	14885	26	AB1 GI	146
04129	50	04568	54, 58	14900	33	AB1 GJ	146
04145	51	04604	54	14901	33	AB1 GK	146
04146	51	04605	54			AB1 GL	146

Reference	Page(s)	Reference	Page(s)	Reference	Page(s)	Reference	Page(s)
AB1 GM	146	AM...		LA9 FF979	43	LAD 9V12	40
AB1 GN	146	AM1DL201	72	LA9 FF980	43	LAD 9V13	40
AB1 GO	146	AR...		LA9 FF981	43	LAD 311	39
AB1 GP	146	AR1 SB2	146	LA9 FF982	42	LAD 91217	41
AB1 GQ	146	AR1 SB3	146	LA9 FG601	42	LAD 92560	38
AB1 GR	146	DB...		LA9 FG602	42	LAD 93217	41
AB1 GS	146	DB6CD102	79	LA9 FG976	42	LAD 96061	38
AB1 GT	146	DB6CD105	79	LA9 FG977	42	LAD T9R1	40
AB1 GU	146	DB6CD110	79	LA9 FG979	43	LAD T9R1V	40
AB1 GV	146	DB6DD102	79	LA9 FG980	43	LGY...	
AB1 GW	146	DB6DD103	79	LA9 FG981	43	LGY112510	17
AB1 GX	146	DB6FD01	79	LA9 FG982	42	LGY116013	17
AB1 GY	146	GK...		LA9 FH601	42	LGY125014	17
AB1 GZ	146	GK2 AF01	39	LA9 FH602	42	LGY410028	17
AB1 R0	146	GV...		LA9 FH976	42	LGY412548	17
AB1 R1	146	GV1 F03	39	LA9 FH977	42	LGY412560	17
AB1 R2	146	GV1 G02	38	LA9 FH982	42	LGY416048	17
AB1 R3	146	GV1 G05	38	LA9 FJ976	42	LGYN1007	17
AB1 R4	146	GV1 G09	38	LA9 FJ977	42	LGYN12512	17
AB1 R5	146	GV1 G10	38	LA9 FJ979	43	LGYN12515	17
AB1 R6	146	GV2 AF01	36	LA9 FJ980	43	LV...	
AB1 R7	146	GV2 AF3	38	LA9 FJ981	43	LV429372	64, 65
AB1 R8	146	GV2 AF4	38	LA9 FJ982	42	LV429373	64, 65
AB1 R9	146	GV2 G245	39	LA9 FK601	42	LV432623	64, 65
AB1 R11	146	GV2 G254	39	LA9 FK602	42	LV432624	64, 65
AB1 R12	146	GV2 G272	39	LA9 FK976	42	NSYA...	
AB1 R13	146	GV2 G345	39	LA9 FK977	42	NSYAS500	55
AB1 RT	146	GV2 G354	39	LA9 FK979	43	NSYAS600	55
AB1 RV	146	GV2 G445	39	LA9 FK980	43	NSYAS800	55
AB1 SA1	146	GV2 G454	39	LA9 FK981	43	NSYAS800L	55
AB1 SA2	146	GV2 G472	39	LA9 FK982	42	NSYB...	
AB1 SA3	146	GV2 G554	39	LA9 FL601	42	NSYBHS500	59
AB1SR6	146	GV2 GA01	39	LA9 FL602	42	NSYBHS600	59
AK...		GV3 G264	38	LA9 FL976	42	NSYBHS800	59
AK5 JB143	70	GV3 G364	38	LA9 FL977	42	NSYBHS800L	59
AK5 JB144	70	GV3 S	38	LA9 FL979	43	NSYBPC516	98, 99
AK5 JB145	70	LA...		LA9 FL980	43	NSYBV500	55
AK5 JB146	70	LA7 F401	43	LA9 FL981	43	NSYBV600	55
AK5 JB149	70	LA7 F402	43	LA9 FL982	42	NSYBV800	55
AK5 JB1410	70	LA7 F403	43	LA9ZA32427	62, 65	NSYBV800L	55
AK5PA211N1	72	LA7 F404	43	LA9ZA32428	62, 65	NSYSDR200BD	80, 81, 82, 83, 84, 85, 86, 87, 88, 90, 91, 92, 93, 94, 96, 97, 98, 99, 106, 107, 108, 109, 110, 111, 112, 114, 115, 116, 118, 119, 120, 128, 129, 130, 132, 133, 134, 135, 136, 137, 138, 139
AK5PA211N2	72	LA7 F405	43	LA9ZA32434	62, 65	NSYF...	
AK5PA211N3	72	LA7 F406	43	LA9ZA32442	62, 65	NSYSFPA	53
AK5PA211PH12	72	LA7 F407	43	LA9ZA32600	65	NSYT...	
AK5PA211PH13	73	LA9 D65A69	40	LA9ZA32621	62, 65	NSYTRA	89
AK5PA211PH23	73	LA9 D65A70	40	LA9ZA32622	62, 65	NSYTRAAB15	100, 101, 122, 123, 140, 141
AK5PA212N1	72	LA9 D1261	38	LA9ZA32623	62, 65	NSYTRAAB35	80, 81, 82, 83, 84, 85, 86, 87, 88, 90, 91, 92, 93, 94, 96, 97, 98, 99, 106, 107, 108, 109, 110, 111, 112, 114, 115, 116, 118, 119, 120, 128, 129, 130, 132, 133, 134, 135, 136, 137, 138, 139, 140, 141
AK5PA212N2	72	LA9 D1263	39	LA9ZA32624	64, 65		
AK5PA212N3	72	LA9 D2561	38	LA9ZA32625	64, 65		
AK5PA212PH12	72	LA9 D3260	38	LA9ZA32626	64, 65		
AK5PA212PH13	72	LA9 D8017	41	LA9ZA32627	64, 65		
AK5PA212PH23	72	LA9 D8069	40	LA9ZX01131	60		
AK5PA231	73	LA9 D8070	40	LA9ZX01243	66, 67		
AK5PA232	73	LA9 D11502	41	LA9ZX01285	66, 67		
AK5PA232S	73	LA9 D11569	40	LA9ZX01287	66, 67		
AK5PA241	73	LA9 D11570	40	LA9ZX01413	66, 67		
AK5PA242	73	LA9 D11571	41	LA9ZX01485	60		
AK5PA532	73	LA9 D12974	41	LA9ZX01495	60		
AK5PA542	73	LA9 D32974	41	LA9ZX01508	60		
AK5PA2311	73	LA9 D80961	38	LA9ZX01515	60		
AK5PA2312	73	LA9 D80962	39	LA9ZX01563	66, 67		
AK5PA2312S	73	LA9 D80963	39	LA9ZX01573	60		
AK5PA5312	73	LA9 D80973	41	LAD 9P3	39		
AK5PC12	72	LA9 E07	38	LAD 9P32	38		
AK5PC12PH	72	LA9 F15076	42	LAD 9P33	39		
AK5PC13	73	LA9 F15077	42	LAD 9R1	40		
AK5PC14	73	LA9 F15082	42	LAD 9R1V	40		
AK5PC32L	72	LA9 F22576	42	LAD 9R3	40		
AK5PC32LPH	72	LA9 F22577	42	LAD 9R3S	41		
AK5PC33	73	LA9 F22582	42	LAD 9SD3	41		
AK5PC33L	73	LA9 FF601	42	LAD 9V5	40		
AK5PC34	73	LA9 FF602	42	LAD 9V6	40		
AK5PC34L	73	LA9 FF976	42	LAD 9V9	40		
AK5PC131	73	LA9 FF977	42				
AK5PC331	73						

Reference	Page(s)	Reference	Page(s)	Reference	Page(s)	Reference	Page(s)
NSYTRAABV35	80, 81, 82, 83, 84, 85, 86, 87, 88, 90, 91, 92, 93, 94, 96, 97, 98, 99, 106, 107, 108, 109, 110, 111, 112, 114, 115, 116, 118, 119, 120, 128, 129, 130, 132, 133, 134, 135, 136, 137, 138, 139, 140, 141	NSYTRAB1040	143	NSYTRACR22	106, 110, 128, 132	NSYTRAL23	80, 84, 86, 87, 88, 90, 91, 92, 93, 99, 100, 106, 107, 114, 115, 116, 118, 119, 128, 129, 132, 134, 135, 136, 137, 138, 139
NSYTRAATM1	80, 81, 82, 83, 84, 85, 86, 87, 88, 90, 91, 92, 93, 94, 96, 97, 98, 99, 106, 107, 108, 109, 110, 111, 112, 114, 115, 116, 118, 119, 120, 128, 129, 130, 132, 133, 134, 135, 136, 137, 138, 139, 140	NSYTRAB1050	143	NSYTRACR22BL	106, 110, 128, 132	NSYTRAL24	80, 84, 86, 87, 88, 90, 91, 92, 93, 99, 99, 100, 106, 107, 114, 116, 118, 119, 128, 129, 132, 134, 135, 136, 137, 138, 139
NSYTRAATP1	80, 81, 82, 83, 84, 85, 86, 87, 88, 90, 91, 92, 93, 94, 96, 97, 98, 99, 106, 107, 108, 109, 110, 111, 112, 114, 115, 116, 118, 119, 120, 128, 129, 130, 132, 133, 134, 135, 136, 137, 138, 139, 140	NSYTRAB1060	143	NSYTRACR23	107, 110, 118, 119, 129, 132	NSYTRAL25	80, 84, 86, 87, 88, 90, 91, 92, 93, 100, 106, 107, 114, 115, 116, 118, 119, 128, 129, 132, 134, 135, 136, 137, 138, 139
NSYTRAB5	142	NSYTRAB1070	143	NSYTRACR23BL	107, 129, 132	NSYTRAL42	81, 84, 87, 88, 90, 91, 93, 98, 101, 107, 108, 115, 116, 119, 120, 129, 130, 133, 137, 139
NSYTRAB5L1N	142	NSYTRAB1080	143	NSYTRACR24	107, 110, 119, 129, 132	NSYTRAL43	81, 84, 87, 88, 90, 91, 93, 98, 101, 107, 108, 115, 116, 119, 120, 129, 130, 133, 137, 139
NSYTRAB6	141, 142	NSYTRAB1090	143	NSYTRACR42	107, 111, 129, 133, 137	NSYTRAL44	81, 84, 87, 88, 90, 91, 93, 98, 101, 107, 108, 115, 116, 119, 120, 129, 130, 133, 137, 139
NSYTRAB6L1N	142	NSYTRAB5100	142	NSYTRACR43	107, 111	NSYTRAL45	81, 84, 87, 88, 90, 91, 93, 98, 101, 107, 108, 115, 116, 119, 120, 129, 130, 133, 137, 139
NSYTRAB8	140, 142	NSYTRAB6100	142	NSYTRACR44	108, 111	NSYTRAL62	81, 84, 96, 97, 98, 108, 109, 111
NSYTRAB10	141, 143	NSYTRAB8100	142	NSYTRACR62	108, 111	NSYTRAL63	81, 84, 96, 97, 98, 108, 109, 111
NSYTRAB510	142	NSYTRAB61100	142	NSYTRACR63	109	NSYTRAL65	81, 84, 96, 97, 98, 108, 109
NSYTRAB520	142	NSYTRABB5	145, 146	NSYTRACR102	109, 112	NSYTRAL102	81, 85, 109, 112
NSYTRAB530	142	NSYTRABB6	145, 146	NSYTRACR162	109, 112	NSYTRAL162	81, 85, 109, 112
NSYTRAB540	142	NSYTRABB8	145, 146	NSYTRACRE24	114, 116, 134	NSYTRAL210	80, 84, 86, 87, 88, 90, 91, 92, 93, 99, 100, 106, 107, 114, 115, 116, 118, 119, 128, 129, 130, 132, 133, 134, 135, 136, 137, 138, 139
NSYTRAB550	142	NSYTRABC	144	NSYTRACRE26	115, 116	NSYTRAL210BL	80, 99, 100, 106, 107, 128, 129
NSYTRAB560	142	NSYTRABCP1	145	NSYTRACRE44	115, 116	NSYTRAL210GR	80, 99, 100, 106, 107, 128, 129
NSYTRAB570	142	NSYTRABCP2	145	NSYTRACRM22	122, 123, 124, 125		
NSYTRAB580	142	NSYTRABCP3	145	NSYTRACRMF22	124, 125		
NSYTRAB590	142	NSYTRABCP4	145	NSYTRACS	138		
NSYTRAB610	142	NSYTRABCP5	144, 145	NSYTRACS2	80, 84, 86, 87, 88, 90, 91, 141		
NSYTRAB620	142	NSYTRABCV	144, 145	NSYTRACS4	81, 84, 141		
NSYTRAB630	142	NSYTRABCV23	144	NSYTRACS6	81, 84, 87, 88, 90, 91, 92, 93, 141		
NSYTRAB640	142	NSYTRABCV35	144	NSYTRACS10	81, 85, 141		
NSYTRAB650	142	NSYTRABCV58	144	NSYTRACS16	81, 85, 141		
NSYTRAB660	142	NSYTRABF5	140, 141, 143	NSYTRACS35	82, 85, 141		
NSYTRAB670	142	NSYTRABF6	143	NSYTRACSR	138		
NSYTRAB680	142	NSYTRABF510	143	NSYTRACSR2	106, 107, 110, 114, 115, 116, 118, 119, 120, 141		
NSYTRAB690	142	NSYTRABF520	143	NSYTRACSR4	107, 108, 111, 115, 116, 119, 120, 141		
NSYTRAB810	142	NSYTRABF530	143	NSYTRACSR6	108, 109, 111, 141		
NSYTRAB820	142	NSYTRABF540	143	NSYTRACSR10	109, 112, 141		
NSYTRAB830	142	NSYTRABF550	143	NSYTRACT22	96, 97		
NSYTRAB840	142	NSYTRABF610	143	NSYTRADR155	100, 101, 122, 123		
NSYTRAB850	142	NSYTRABF620	143	NSYTRAF2	141		
NSYTRAB860	142	NSYTRABF630	143	NSYTRAF4	141		
NSYTRAB870	142	NSYTRABF640	143	NSYTRAF6	141		
NSYTRAB880	142	NSYTRABF650	143	NSYTRAFT	80, 81, 84, 86, 87, 88, 90, 91, 92, 93, 96, 97, 98, 99, 106, 107, 108, 109, 110, 111, 112, 114, 115, 116, 118, 119, 120, 128, 129, 130, 132, 133, 134, 135, 136, 137, 138, 139, 140		
NSYTRAB890	142	NSYTRABF650	143	NSYTRAF22	96, 97, 140		
NSYTRAB1010	143	NSYTRABFPV5	143	NSYTRAF6	96, 97, 140		
NSYTRAB1020	143	NSYTRABFPV6	143	NSYTRAFYE	96, 97, 140		
NSYTRAB1030	143	NSYTRABFPV8	143	NSYTRAL22	80, 84, 86, 87, 88, 90, 91, 92, 93, 99, 100, 106, 107, 114, 115, 116, 118, 119, 128, 129, 132, 134, 135, 136, 137, 138, 139		
		NSYTRABMP1	142, 144				
		NSYTRABMP2	143, 144				
		NSYTRABMP3	144				
		NSYTRABPV5	142				
		NSYTRABPV6	142				
		NSYTRABPV8	142				
		NSYTRAC22	80, 81, 84, 85, 98				
		NSYTRAC22BL	80, 81, 84, 85, 98				
		NSYTRAC23	86, 87, 90, 92, 93				
		NSYTRAC24	85, 87, 90, 91				
		NSYTRAC25	99				
		NSYTRAC162	81, 85				
		NSYTRAC952	83				
		NSYTRACB103	98, 99				
		NSYTRACE24	87, 88, 91, 93				
		NSYTRACE26	88, 91				
		NSYTRACED24	93				
		NSYTRACEP24	87, 88, 91, 93				
		NSYTRACH12	138, 139				
		NSYTRACH13	138				
		NSYTRACH22	139				
		NSYTRACM22	100, 101				
		NSYTRACP1	83				
		NSYTRACP2	83				
		NSYTRACP43	130, 133				
		NSYTRACP44	130, 133				
		NSYTRACPE26	135				
		NSYTRACPK22	136, 137				
		NSYTRACPK23	137				
		NSYTRACPK24	137				

Reference	Page(s)	Reference	Page(s)	Reference	Page(s)	Reference	Page(s)
NSYTRAL220	80, 84, 86, 87, 88, 90, 91, 92, 93, 99, 100, 106, 107, 114, 115, 116, 118, 119, 128, 129, 132, 134, 135, 136, 137, 138, 139	NSYTRAPR42	106, 107, 110, 111, 128, 129, 132, 133	NSYTRP44BL	126, 130	NSYTRR352PE	103, 112
NSYTRAL352	82, 85, 109, 112	NSYTRAPT16	81, 141	NSYTRP44PE	126, 133	NSYTRV22	78, 80
NSYTRAL410	81, 84, 87, 88, 90, 91, 93, 98, 101, 107, 108, 115, 116, 119, 120, 129, 130, 133, 137, 139	NSYTRAPT35	82, 141	NSYTRR22	102, 106	NSYTRV22AR	76, 80
NSYTRAL410BL	81, 98, 101, 107, 108, 129, 130	NSYTRASB4	80, 81, 82, 83, 84, 85, 86, 87, 88, 90, 91, 92, 93, 94, 96, 97, 98, 99, 100, 101, 106, 107, 108, 109, 110, 111, 112, 114, 115, 116, 118, 119, 120, 122, 123, 124, 125, 128, 129, 130, 132, 133, 134, 135, 136, 137, 138, 139, 141	NSYTRR22AR	102, 106	NSYTRV22BL	76, 80
NSYTRAL410GR	81, 98, 101, 107, 108, 129, 130	NSYTRASJ2	96, 97	NSYTRR22BL	102, 106	NSYTRV22M	79, 100
NSYTRAL420	81, 84, 87, 88, 90, 91, 93, 98, 101, 107, 108, 115, 116, 119, 120, 129, 130, 133, 137, 139	NSYTRASJ3	96, 97	NSYTRR22M	105, 122	NSYTRV22MBL	79, 100
NSYTRAL502 *	82	NSYTRASJ4	96, 97	NSYTRR22MBL	105, 122	NSYTRV22MPE	79, 101
NSYTRAL503 *	82	NSYTRASJ6	96, 97	NSYTRR22MF	105, 124	NSYTRV22PE	77, 84
NSYTRAL610	81, 84, 96, 97, 98, 108, 109, 111	NSYTRASV1	93, 119, 120, 137, 141	NSYTRR22MFB	105, 124	NSYTRV22RD	76, 80
NSYTRAL610BL	81, 108, 109	NSYTRASV2	93, 119, 120, 137, 141	NSYTRR22MFF	105, 123	NSYTRV22SC	78, 92
NSYTRAL610GR	81, 108, 109	NSYTRAX6L1L3	142	NSYTRR22MP	105, 125	NSYTRV22ST	78, 92
NSYTRAL702	82	NSYTRAXP610	142	NSYTRR22MPBL	105, 125	NSYTRV22TB	78, 93
NSYTRAL952	83	NSYTRAXP620	142	NSYTRR22MPE	105, 123	NSYTRV22WH	76, 80
NSYTRAL1502	83	NSYTRAXP630	142	NSYTRR22SC	103, 110, 109	NSYTRV23	78, 86
NSYTRALF1610	94	NSYTRAXP640	142	NSYTRR22SCAR	104, 118	NSYTRV23BL	78, 86
NSYTRALM22	123, 125	NSYTRAXP650	142	NSYTRR22TB	104, 119	NSYTRV23PE	78, 90
NSYTRALR62	108, 109	NSYTRAXPV6	142	NSYTRR23	102, 107	NSYTRV24	78, 87
NSYTRALR102	106	NSYTRH12	127, 138	NSYTRR23AR	102, 107	NSYTRV24BL	78, 87
NSYTRALR162	106	NSYTRH12PE	127, 139	NSYTRR23BL	102, 107	NSYTRV24D	78, 87
NSYTRALV24	87, 88	NSYTRH13	127, 138	NSYTRR23PE	103, 110	NSYTRV24DBL	78, 87
NSYTRALV24R	102, 114, 115, 126, 134	NSYTRH22	127, 139	NSYTRR23SC	104, 119	NSYTRV24DPE	78, 91
NSYTRALV62	81	NSYTRP22	126, 128	NSYTRR23SCAR	104, 119	NSYTRV24SCD	93
NSYTRALV102	81	NSYTRP22AR	126, 128	NSYTRR23TB	104, 119	NSYTRV25LL	99
NSYTRALV162	81	NSYTRP22BL	126, 128	NSYTRR24	102, 107	NSYTRV25LLPE	99
NSYTRALV352	82	NSYTRP22PE	126, 132	NSYTRR24AR	102, 107	NSYTRV25NLPPE	99
NSYTRALVR62	81	NSYTRP22SC	127, 132, 136	NSYTRR24BL	102, 107	NSYTRV26T	78, 88
NSYTRALVR102	81	NSYTRP22TB	127, 137	NSYTRR24D	102, 104, 114	NSYTRV26TBL	78, 88
NSYTRALVR162	81	NSYTRP23	126, 129	NSYTRR24DBL	104, 114	NSYTRV26TC	78, 88
NSYTRALVR352	82	NSYTRP23AR	126, 129	NSYTRR24DPE	104, 116	NSYTRV26TPE	91
NSYTRAP22	80, 81, 84, 85, 98	NSYTRP23BL	126, 129	NSYTRR24M	105, 123	NSYTRV42	76, 81
NSYTRAP22BL	80, 81, 84, 85, 98	NSYTRP23PE	126, 132	NSYTRR24MBL	105, 123	NSYTRV42AR	76, 81
NSYTRAP23	86, 87, 90, 92, 93	NSYTRP23SC	127, 137	NSYTRR24MF	105, 125	NSYTRV42BK	76, 81
NSYTRAP24	87, 90, 91	NSYTRP24	126, 129	NSYTRR24MFF	105, 125	NSYTRV42BL	76, 81
NSYTRAP24	85, 89	NSYTRP24BL	126, 129	NSYTRR24MP	105, 125	NSYTRV42BR	81
NSYTRAPD12	138, 139	NSYTRP24D	126, 127, 134	NSYTRR24MPBL	105, 125	NSYTRV42GN	76, 81
NSYTRAPD13	138	NSYTRP24DBL	127, 134	NSYTRR24PE	103, 110	NSYTRV42M	79, 101
NSYTRAPE24	87, 88, 91, 93	NSYTRP24DPE	127, 134	NSYTRR24PPE	103, 111	NSYTRV42MBL	79, 101
NSYTRAPEN1	144	NSYTRP24SC	127, 137	NSYTRR24SC	104, 119	NSYTRV42MPE	79, 101
NSYTRAPEN2	144	NSYTRP26T	135	NSYTRR24SCD	104, 120	NSYTRV42NE	79, 98
NSYTRAPEN3	144	NSYTRP26TBL	135	NSYTRR26T	104, 115	NSYTRV42PE	77, 84
NSYTRAPLOT	144	NSYTRP26TPE	135	NSYTRR26TBL	104, 115	NSYTRV42RD	76, 81
NSYTRAPM22	100, 101	NSYTRP42	126, 129	NSYTRR26TC	104, 115	NSYTRV42SC	78, 93
NSYTRAPR23	107, 110, 118, 119, 120, 129, 132, 136	NSYTRP42BL	126, 129	NSYTRR26TPE	104, 116	NSYTRV42SCD	78, 93
NSYTRAPR24	107, 110, 119, 129, 132, 137	NSYTRP42PE	126, 133	NSYTRR42	102, 107	NSYTRV42SFD	78, 94
		NSYTRP43	126, 130	NSYTRR42AR	102, 107	NSYTRV42SF5LA	94
		NSYTRP43BL	126, 130	NSYTRR42BL	102, 107	NSYTRV42SF5LD	78, 94
		NSYTRP43PE	126, 133	NSYTRR42PE	103, 111	NSYTRV42SF6	78, 94
		NSYTRP44	126, 130	NSYTRR42SC	104, 119	NSYTRV42SF6LA	94
				NSYTRR42SCAR	104, 119	NSYTRV42SF6LD	78, 94
				NSYTRR42TB	104, 120	NSYTRV42ST	78, 93
				NSYTRR43	102, 107	NSYTRV42STAR	78, 93
				NSYTRR43AR	102, 107	NSYTRV42TB	78, 93
				NSYTRR43BL	102, 107	NSYTRV42WH	76, 81
				NSYTRR43PE	103, 111	NSYTRV42YE	81
				NSYTRR44	102, 108	NSYTRV43	78, 87
				NSYTRR44AR	102, 108	NSYTRV43BL	78, 87
				NSYTRR44BL	102, 108	NSYTRV43PE	77, 78, 90
				NSYTRR44D	102, 104, 114, 115	NSYTRV44	78, 87
				NSYTRR44DBL	104, 115	NSYTRV44BL	78, 87
				NSYTRR44DPE	104, 116	NSYTRV44D	78, 88
				NSYTRR44PE	103, 111	NSYTRV44DBL	78, 88
				NSYTRR62	102, 108	NSYTRV44DPE	78, 91
				NSYTRR62BL	102, 108	NSYTRV44PE	77, 78, 91
				NSYTRR62PE	103, 111	NSYTRV44SCD	78
				NSYTRR63	102, 109	NSYTRV62	76, 81
				NSYTRR102	102, 109	NSYTRV62BL	76, 81
				NSYTRR102BL	102, 109	NSYTRV62NE	79, 98
				NSYTRR102PE	102, 112	NSYTRV62PE	77, 84, 111
				NSYTRR162	102, 109	NSYTRV62TT	96, 97
				NSYTRR162BL	102, 109	NSYTRV62TTD	79, 96
				NSYTRR162PE	103, 112	NSYTRV62TTPE	79, 97
				NSYTRR352	102, 109	NSYTRV102	78, 81
				NSYTRR352BL	102, 109	NSYTRV102BL	76, 81

Reference	Page(s)
NSYTRV102PE	77, 85
NSYTRV162	76, 81
NSYTRV162BL	76, 81
NSYTRV162PE	77, 85
NSYTRV162SF	78, 94
NSYTRV352	76, 82
NSYTRV352BL	76, 82
NSYTRV352PE	77, 85
NSYTRV502	76, 82
NSYTRV502BL	76, 82
NSYTRV502PE	77, 85
NSYTRV702	76, 82
NSYTRV702BL	76, 82
NSYTRV952BB	77, 83
NSYTRV952BC	77, 83
NSYTRV1502BB	77, 83
R9X...	
R9XE110	32
R9XE210	32
R9XE310	32
R9XE410	32
R9XFC04	32
R9XFH112	32
R9XFH118	32
R9XFH157	32
R9XFH212	32
R9XFH218	32
R9XFH257	32
R9XFH312	32
R9XFH318	32
R9XFH357	32
R9XFH412	32
R9XFH418	32
R9XFH457	32
R9XFH518	32
R9XFH518G	32
R9XFH557	32
R9XT20	32





All technical information about products listed in this guide are now available on: www.se.com

Browse the "product datasheet" to check out:

- > Characteristics
- > Dimensions
- > And also links to user guides, curves, CAD files...



From the home page, type the product reference into the "Search" box.

Example

Home | Site map
LC1D09P7

Then, clic on the green reference



The product datasheet appears with the technical data and product characteristics at the bottom of the page.

Contactors 4kW to 80kW / 5 pole relays as standard - TeSys D

Overview Downloads Support Find a Distributor Part No. data FAQs

TeSys D Hide

Download & Documents

Contactors Reversing contactors Add-on blocks Accessories Spare parts

Your selection

Characteristics Remove all

Poles description: 3P

Power pole contact composition: 3

NO

Discover LC1D09P7 by

- Characteristics
- Download & Documents

LC1D09P7
TeSys D contactor - 3P(3 NO) - AC-3 - <= 440 V 9 A - 230 V AC coil

[Download LC1D09P7 product datasheet](#)

Characteristics

Main	
Commercial Status	Commercialised
Range of product	TeSys D
Product or component type	Contactor
Device short name	LC1D
Contactor application	Motor control Resistive load
Utilisation category	AC-1 AC-3
Poles description	3P

Access to related downloads



You can get this information in one pdf file.

Schneider Electric Industries SAS

35, rue Joseph Monier
CS 30323
92506 Rueil Malmaison Cedex
France

RCS Nanterre 954 503 439
Capital social 896 313 776 €
www.se.com

As standards, specifications and designs change from time to time, please ask for confirmation of the information given in this publication.

Publication: Schneider Electric Industries SAS
Photos: Schneider Electric
Printed:



This document has been printed on ecological paper.