

Canalis KBC

KBC-10CC211

KBC-10CB20

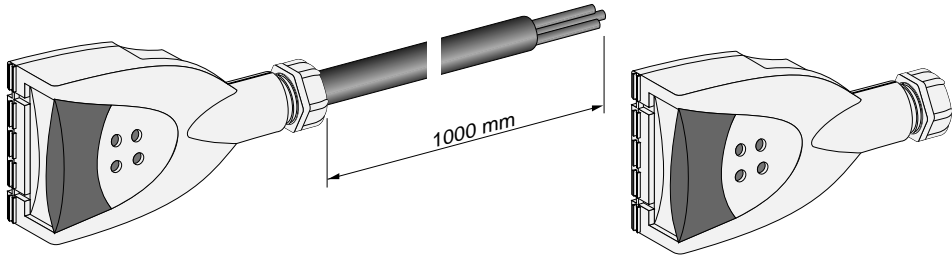

KBC-10CB20

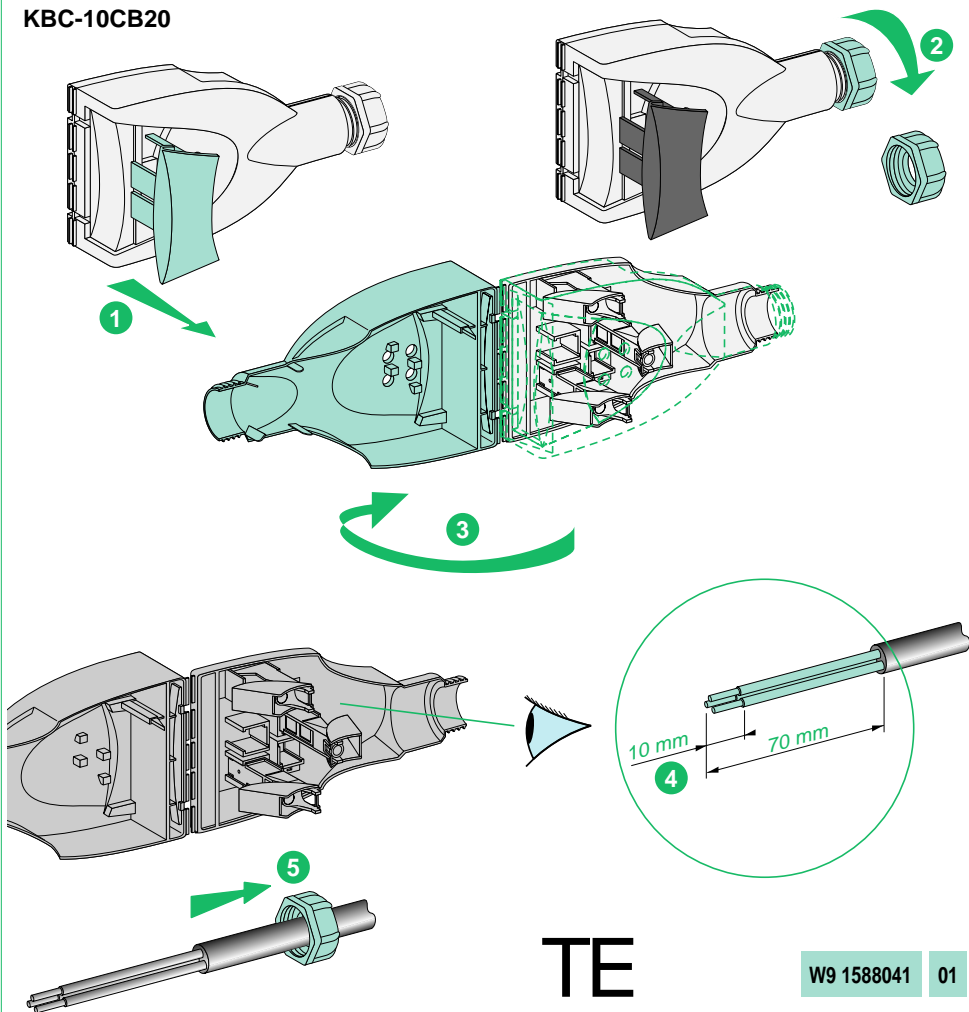

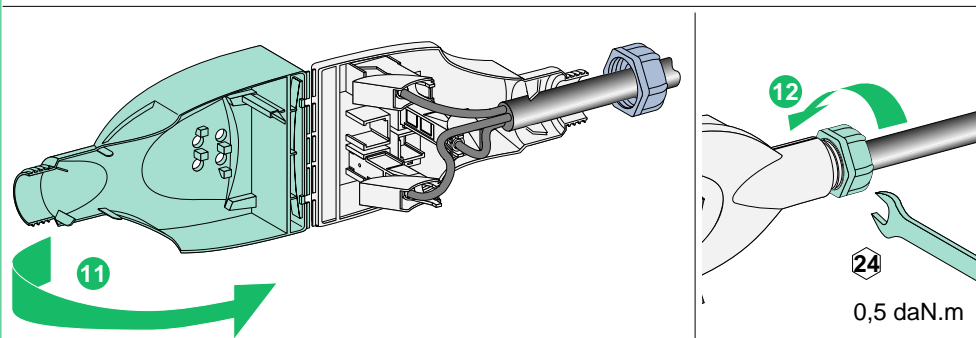
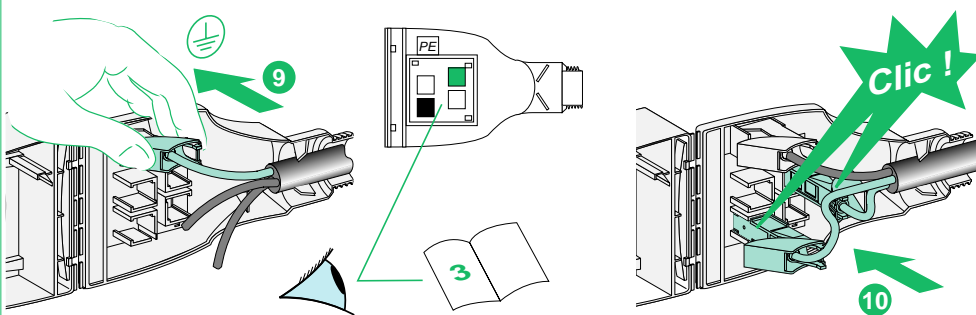
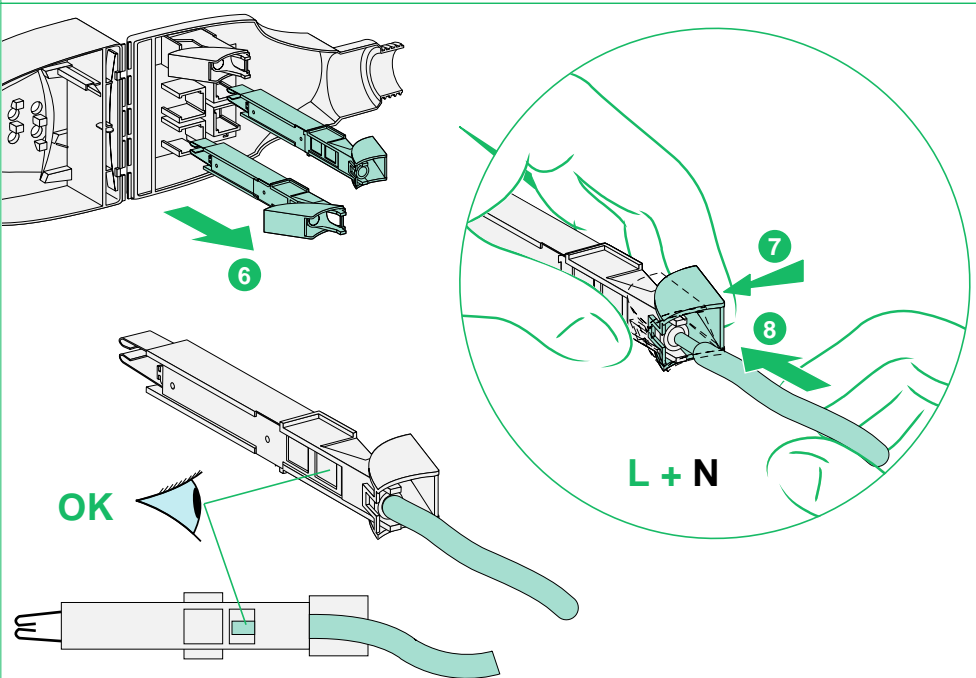

L + N + PE

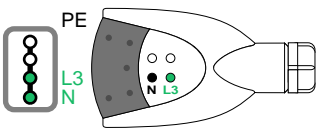
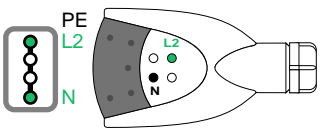
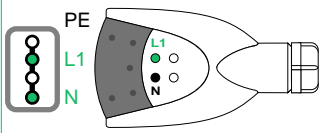
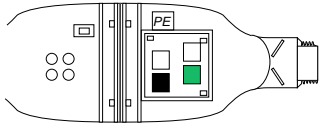
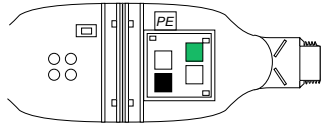
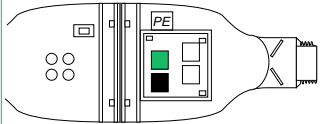

L1 + N + PE

L2 + N + PE

L3 + N + PE

L + L + PE

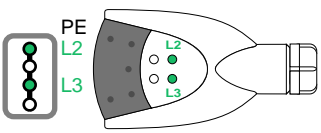
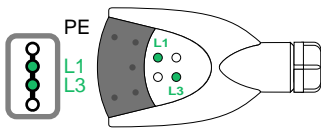
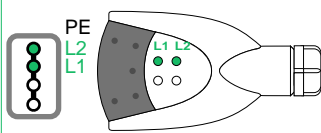
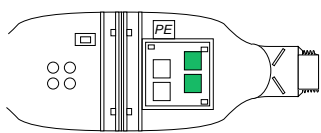
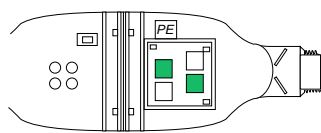
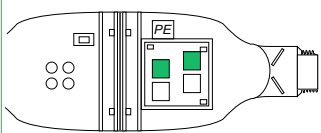

L1 + L2 + PE

L1 + L3 + PE

L2 + L3 + PE

L + N + PE

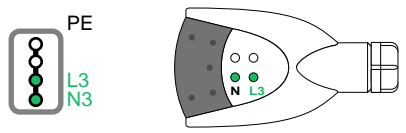
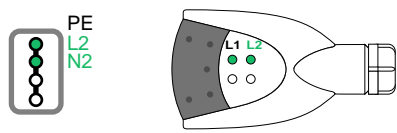
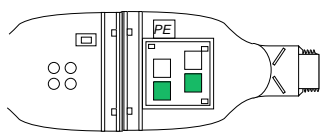
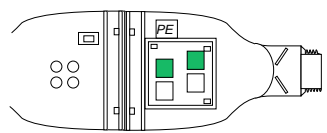

L2 + N2 (L1 = N2) + PE

L3 + N3 (N = N3) + PE

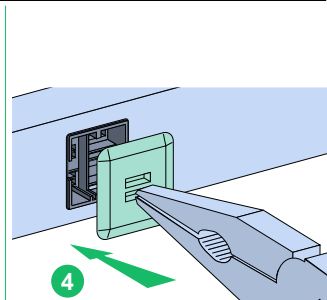
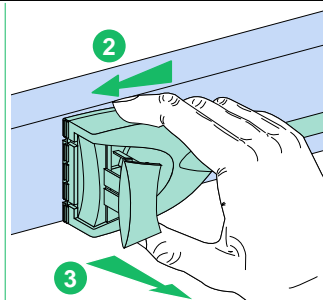
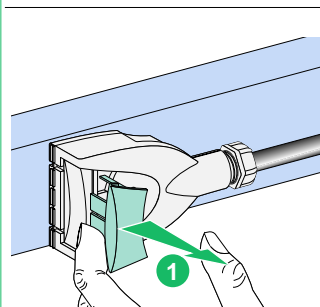
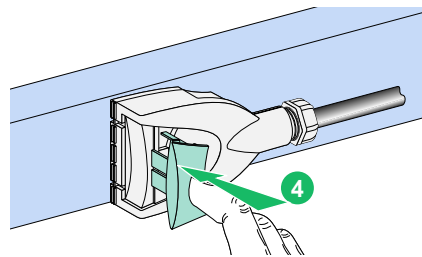
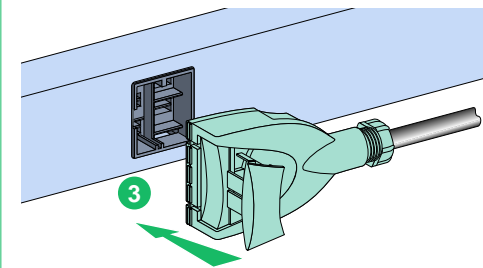
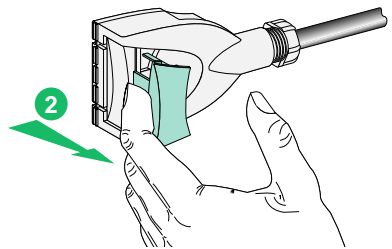
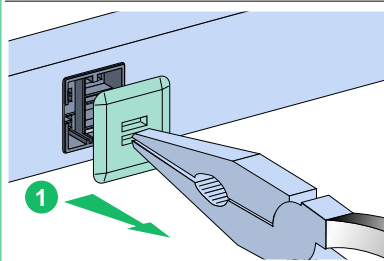
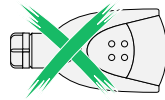
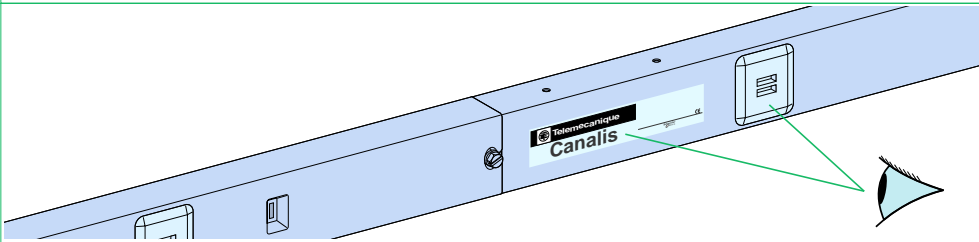

KDP

