



## Inline mixed-flow fan

# Turbo

Air capacity — up to 2350 m<sup>3</sup>/h

### Use

- Supply and exhaust ventilation systems installed in various premises.
- Mounting in kitchens, bathrooms and other humid premises.
- Ventilation air ducts requiring high pressure, powerful air flow and low noise level.
- Compatible with Ø100 up to 315 mm round air ducts.

### Design

- Casing made of impact- and corrosion-resistant ABS plastic (Ø100-200) or polypropylene of low-flammability (Ø250-315).
- Ventilation unit with terminal box. Can be turned to any position.
- Special casing design permits easy dismantling of the impeller and motor block for fan servicing without dismantling the air duct.

### Motor

- Double-speed single-phase motor on ball bearings.
- Equipped with thermal overload protection.

### Speed control

- The built-in switch (option **US**) or external switch for multi-speed fans (available upon separate order) are used to select one of two capacity modes.
- Smooth speed control is possible with a built-in speed controller (option **FR**) or an external thyristor speed controller (available upon separate order).

### Mounting

- Due to compact design the fan is the ideal solution for mounting in limited spaces, including space behind a false ceiling.
- The fan can be installed in any section of the ventilation system from intake to the end of the ductworks.
- Wall or ceiling mounting with a mounting plate.

- TD** – mounting kit for installation of one diameter fans in parallel (for boosting capacity)



- TL** – mounting kit for installation of one diameter fans in series (for boosting pressure).



## ■ Modifications and options

- **T** – adjustable run-out timer regulated from 2 to 30 minutes.
- **US** – three-position speed switch integrated in the fan.



- **FR** – integrated smooth speed controller, power cord with a socket or a plug (**FR1**).



- **G1** – temperature and speed controller with a sensor built into the fan casing. The fan is equipped with a power cord with a socket or plug (**G11**). The options G and G1 are used for automatic speed control depending on indoor temperature. The best ventilation solution for premises requiring permanent temperature control as greenhouses, orangeries, etc.



- **W** – the fan is equipped with a power cord and a socket or plug (**W1**).
- **max** – high-powered motor.

- **G** – temperature and speed controller with external temperature sensor (with 4 m cable). The fan is equipped with a power cord with a socket or a plug (**G1**).

## ■ Specifications

Parameters	Turbo 100		Turbo 125		Turbo 125 max		Turbo 150	
	min	max	min	max	min	max	min	max
Speed								
Voltage [V / 50 Hz]	1~230		1~230		1~230		1~230	
Power [W]	21	33	23	37	28	54	30	60
Current [A]	0,12	0,2	0,19	0,26	0,1	0,16	0,17	0,27
Maximum air capacity [m <sup>3</sup> /h]	145	187	220	280	285	345	467	552
RPM [min <sup>-1</sup> ]	2450	2500	1960	2500	1875	2500	1670	2450
Sound pressure level at 3 m distance [dBA]	28	35	29	36	31	42	33	44
Max. operating temperature [°C]	60		60		60		60	
Ingress protection rating	IP X4		IP X4		IP X4		IP X4	

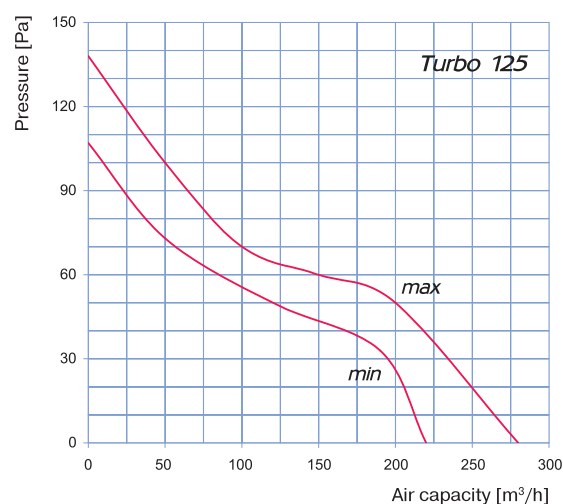
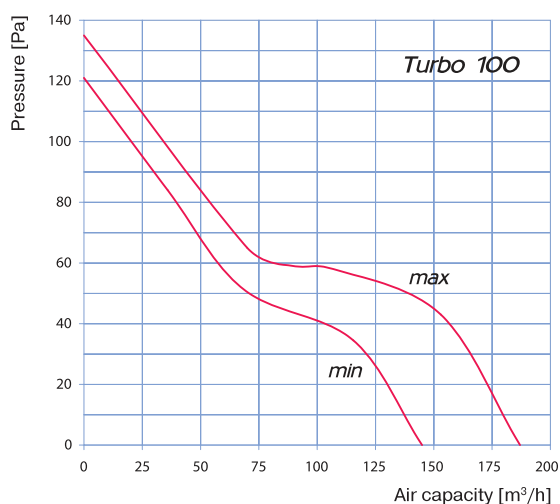

## ■ Specifications

Parameters	Turbo 160		Turbo 200		Turbo 250		Turbo 315	
	min	max	min	max	min	max	min	max
Speed								
Voltage [V / 50 Hz]	1~230		1~230		1~230		1~230	
Power [W]	30	60	90	125	125	177	225	330
Current [A]	0,17	0,27	0,4	0,55	0,54	0,79	0,98	1,43
Maximum air capacity [m <sup>3</sup> /h]	467	552	830	1040	1110	1400	1760	2350
RPM [min <sup>-1</sup> ]	1670	2450	2045	2510	1955	2440	1980	2660
Sound pressure level at 3 m distance [dBA]	33	44	45	52	47	55	49	58
Max. operating temperature [°C]	60		60		60		60	
Ingress protection rating	IP X4		IP X4		IP X4		IP X4	

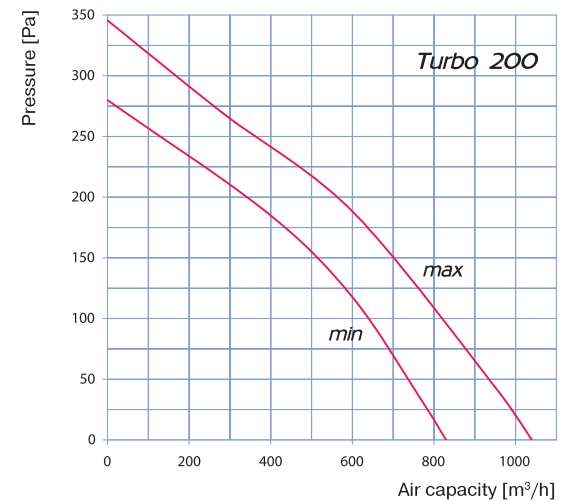
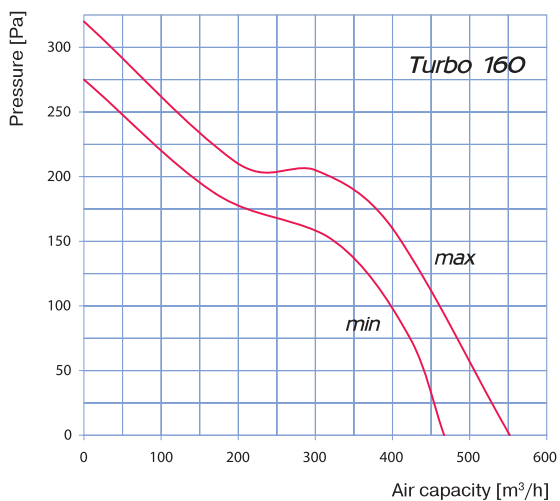
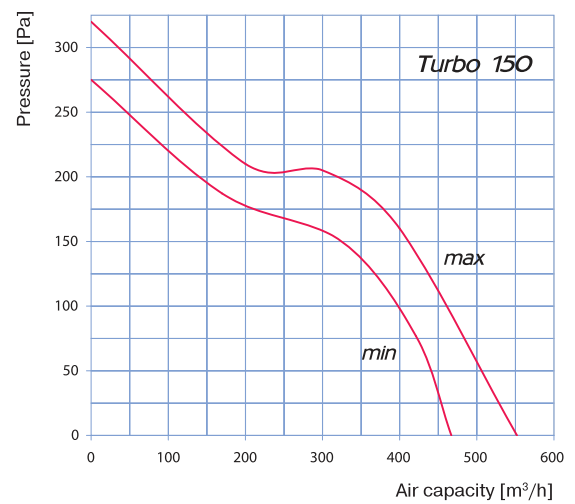
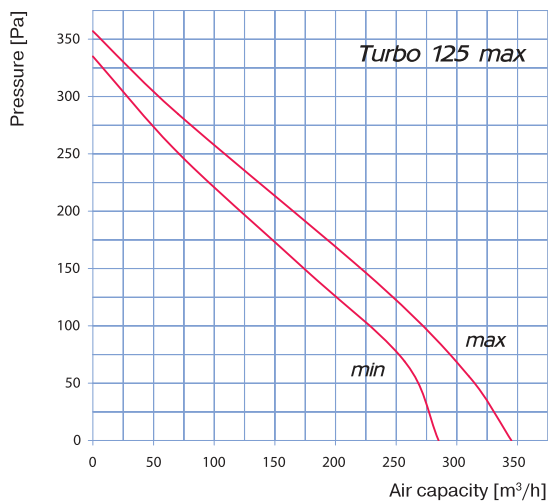

## ■ Specifications

Parameters	Turbo 100 in series		Turbo 125 in series		Turbo 125 max in series		Turbo 150 in series	
	min	max	min	max	min	max	min	max
Speed								
Voltage [V / 50 Hz]	1~230		1~230		1~230		1~230	
Power [W]	42	66	46	74	56	108	60	120
Current [A]	0,24	0,40	0,38	0,52	0,20	0,32	0,34	0,54
Maximum air capacity [m <sup>3</sup> /h]	145	187	220	280	285	345	467	552
RPM [min <sup>-1</sup> ]	2450	2500	1960	2500	1875	2500	1670	2450
Sound pressure level at 3 m distance [dBA]	32	40	34	41	36	46	39	49
Max. operating temperature [°C]	60		60		60		60	
Ingress protection rating	IP X4		IP X4		IP X4		IP X4	

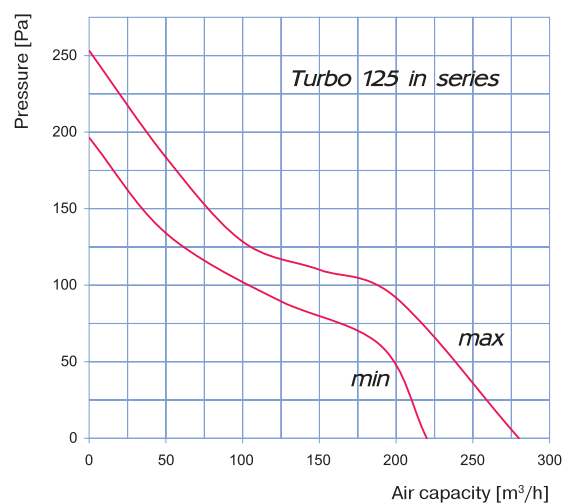
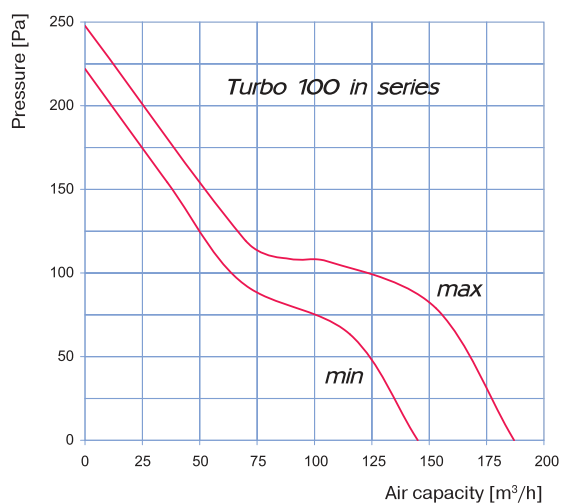
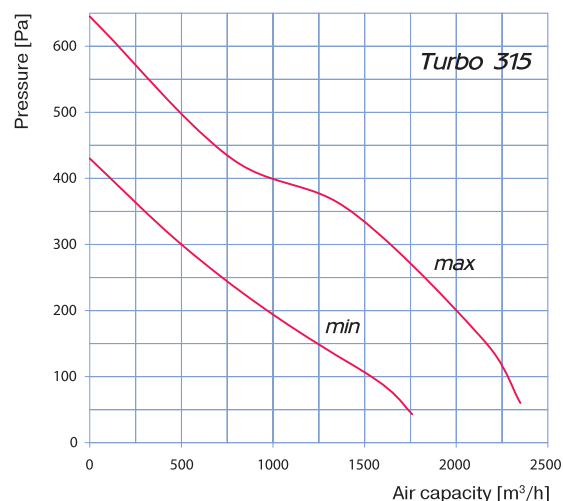
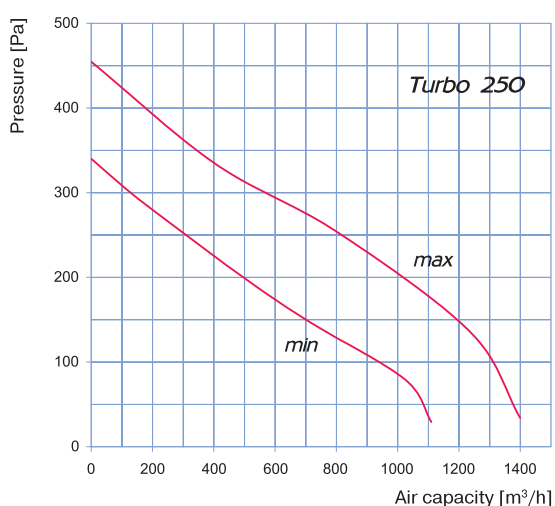

## ■ Specifications

Parameters	Turbo 160 in series		Turbo 200 in series		Turbo 250 in series		Turbo 315 in series	
	min	max	min	max	min	max	min	max
Speed								
Voltage [V / 50 Hz]	1~230		1~230		1~230		1~230	
Power [W]	60	120	180	250	250	354	450	660
Current [A]	0,34	0,54	0,80	1,10	1,08	1,58	1,96	2,86
Maximum air capacity [m <sup>3</sup> /h]	467	552	830	1040	1110	1400	1760	2350
RPM [min <sup>-1</sup> ]	1670	2450	2045	2510	1955	2440	1980	2660
Sound pressure level at 3 m distance [dBA]	39	49	51	57	54	61	55	65
Max. operating temperature [°C]	60		60		60		60	
Ingress protection rating	IP X4		IP X4		IP X4		IP X4	

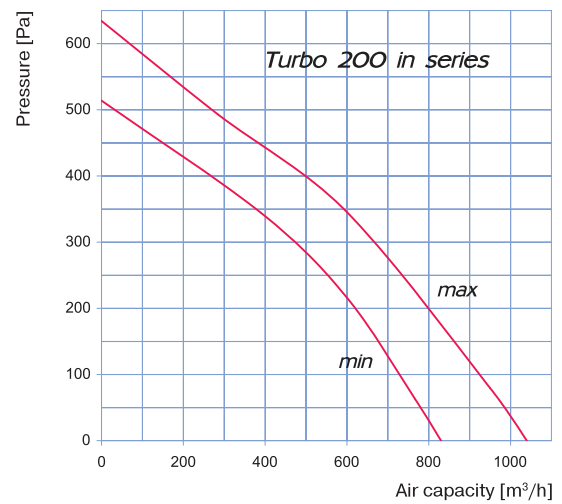
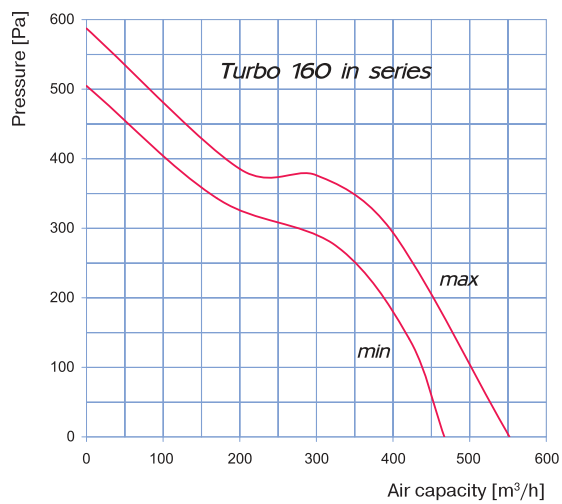
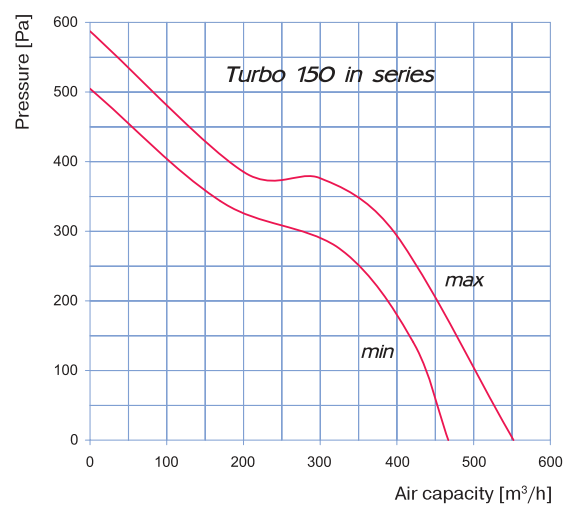
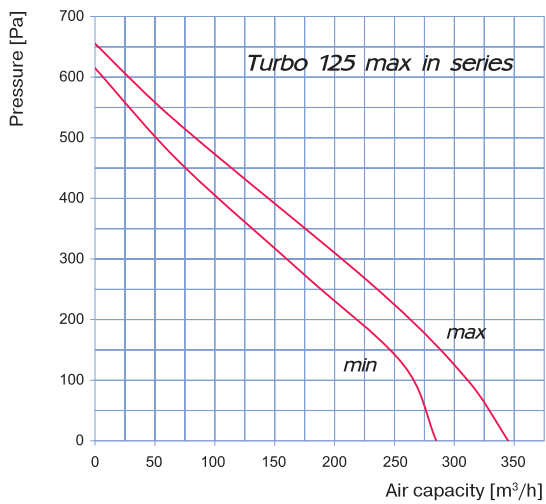

## ■ Specifications

Parameters	Turbo 100 in parallel		Turbo 125 in parallel		Turbo 125 max in parallel		Turbo 150 in parallel	
	min	max	min	max	min	max	min	max
Speed								
Voltage [V / 50 Hz]	1~230		1~230		1~230		1~230	
Power [W]	42	66	46	74	56	108	60	120
Current [A]	0,24	0,40	0,38	0,52	0,20	0,32	0,34	0,54
Maximum air capacity [m <sup>3</sup> /h]	290	374	440	560	570	690	934	1104
RPM [min <sup>-1</sup> ]	2450	2500	1960	2500	1875	2500	1670	2450
Sound pressure level at 3 m distance [dBA]	32	40	34	41	36	46	39	49
Max. operating temperature [°C]	60		60		60		60	
Ingress protection rating	IP X4		IP X4		IP X4		IP X4	

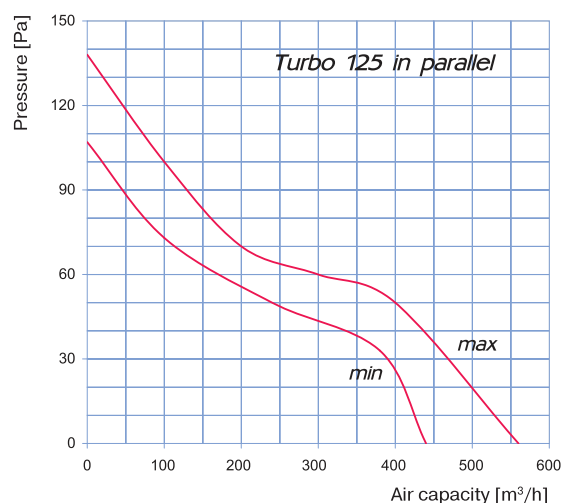
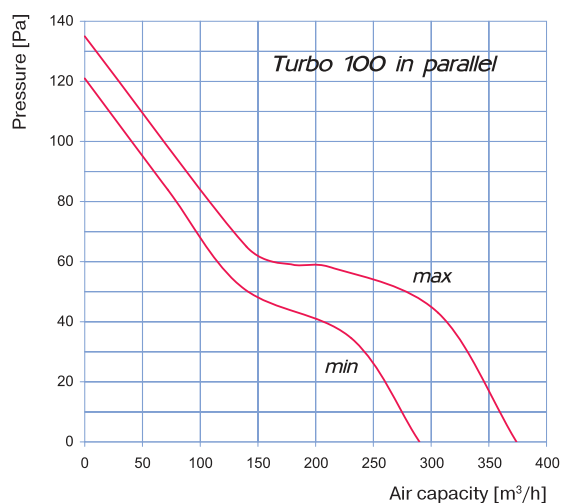
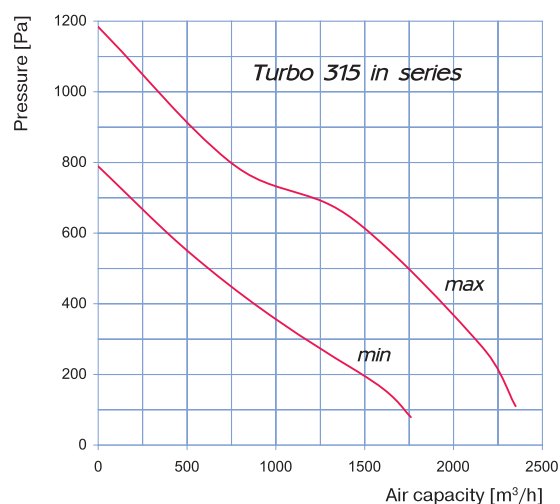
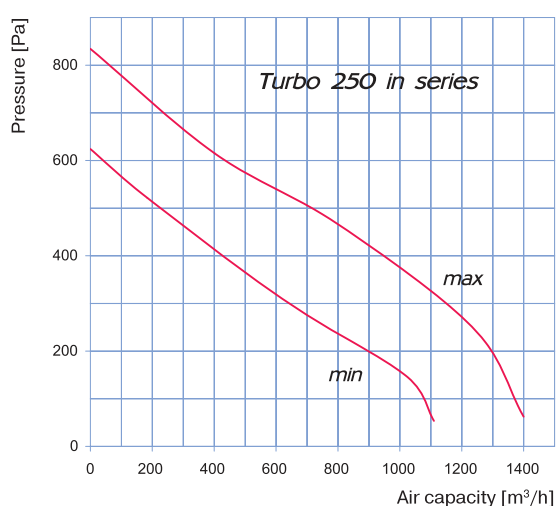

## ■ Specifications

Parameters	Turbo 160 in parallel		Turbo 200 in parallel		Turbo 250 in parallel		Turbo 315 in parallel	
	min	max	min	max	min	max	min	max
Speed								
Voltage [V / 50 Hz]	1~230		1~230		1~230		1~230	
Power [W]	60	120	180	250	250	354	450	660
Current [A]	0,34	0,54	0,80	1,10	1,08	1,58	1,96	2,86
Maximum air capacity [m <sup>3</sup> /h]	934	1104	1660	2080	2220	2800	3520	4700
RPM [min <sup>-1</sup> ]	1670	2450	2045	2510	1955	2440	1980	2660
Sound pressure level at 3 m distance [dBA]	39	49	51	57	54	61	55	65
Max. operating temperature [°C]	60		60		60		60	
Ingress protection rating	IP X4		IP X4		IP X4		IP X4	

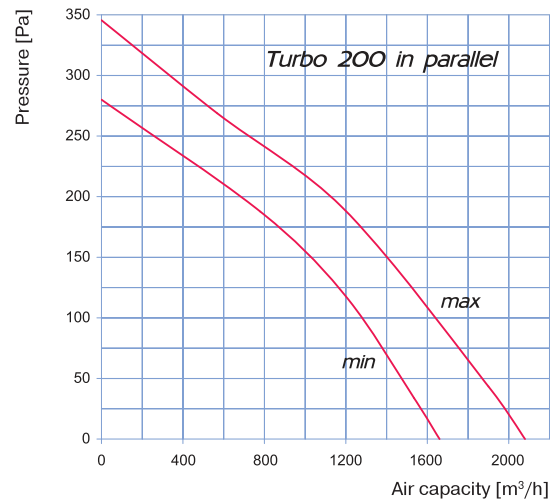
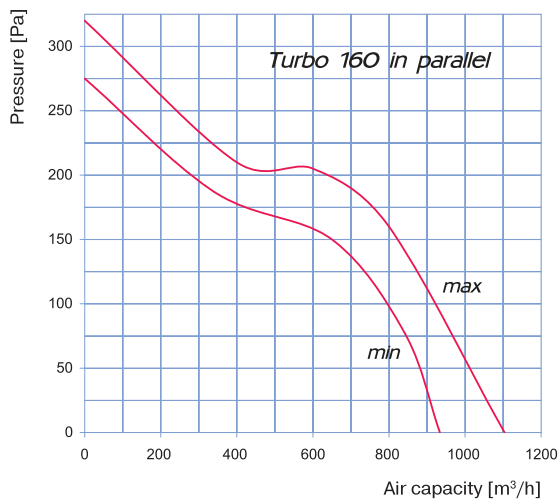
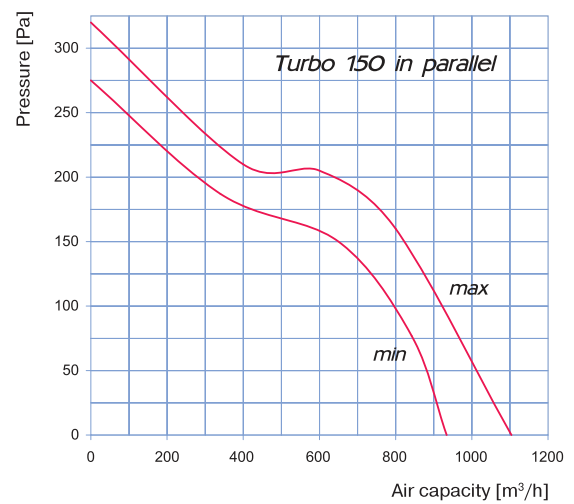
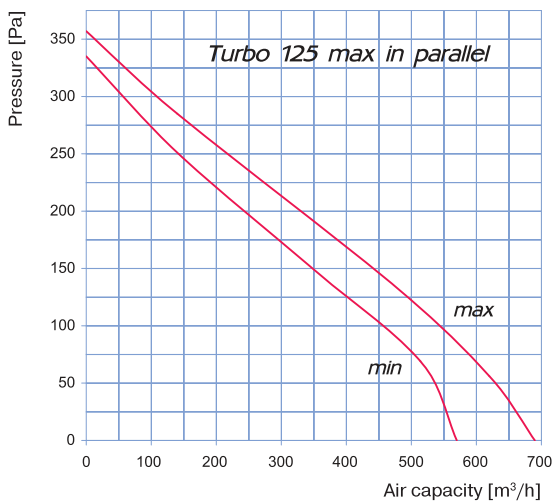

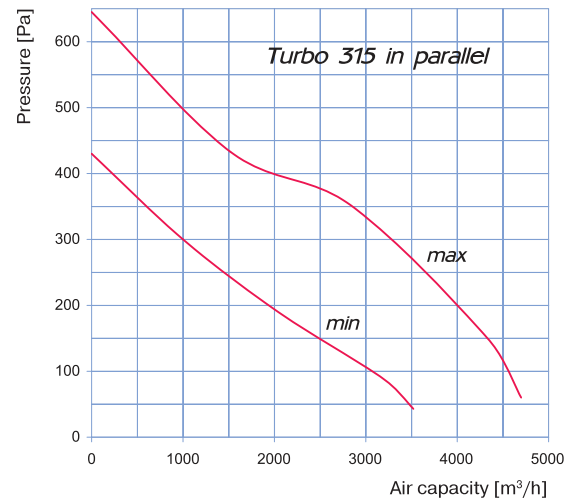
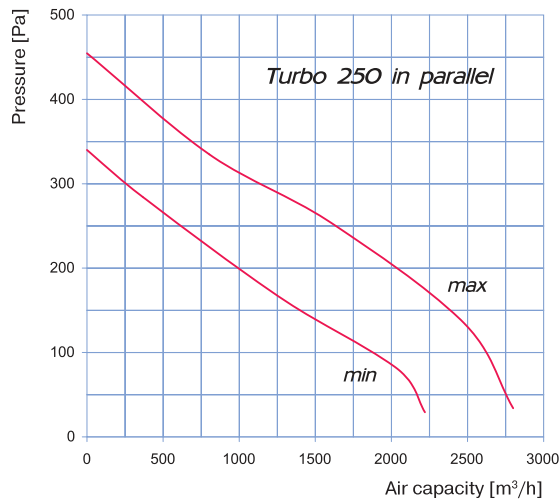

### Overall dimensions

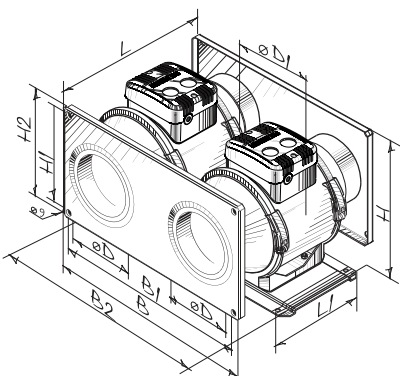
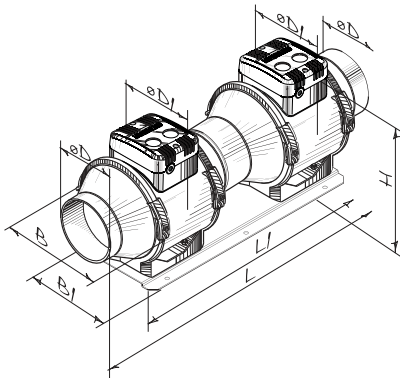
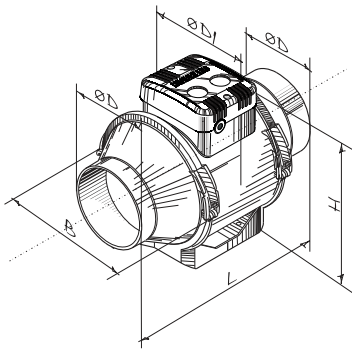

Type	Dimensions [mm]					Weight [kg]
	$\varnothing D$	$\varnothing D_1$	B	H	L	
Turbo 100	96	140	167	190	246	1,4
Turbo 125	123	140	167	190	246	1,4
Turbo 125 max	123	195	223	250	295	3,0
Turbo 150	146	195	223	250	295	3,0
Turbo 160	158	195	233	250	295	3,0
Turbo 200	199	209	239	261	295,5	6,4
Turbo 250	247	257	287	323	383	8,3
Turbo 315	310	323	362	408	445	11,4

Type	Dimensions [mm]							Weight [kg]
	$\varnothing D$	$\varnothing D_1$	B	B <sub>1</sub>	H	L	L <sub>1</sub>	
Turbo 100 in series	96	140	167	140	196	492	372	3,3
Turbo 125 in series	123	140	167	140	196	492	372	3,3
Turbo 125 max in series	123	195	223	140	256	590	440	6,3
Turbo 150 in series	148	195	223	140	256	590	440	6,3
Turbo 160 in series	158	195	233	140	256	590	440	6,3
Turbo 200 in series	197	209	239	190	270	595	440	13,5
Turbo 250 in series	247	257	287	190	331	766	580	17,6
Turbo 315 in series	310	323	362	240	420	890	700	24,2

Type	Dimensions [mm]										Weight [kg]
	$\varnothing D$	$\varnothing D_1$	B	B <sub>1</sub>	B <sub>2</sub>	H	H <sub>1</sub>	H <sub>2</sub>	L	L <sub>1</sub>	
Turbo 100 in parallel	100	140	320	300	380	185	160	178	246	140	4
Turbo 125 in parallel	125	140	320	300	380	185	160	178	261	140	4
Turbo 125 max in parallel	125	195	395	375	430	228	200	220	295	180	7,5
Turbo 150 in parallel	150	195	395	375	430	228	200	220	310	180	7,5
Turbo 160 in parallel	160	195	395	375	430	228	200	220	310	180	7,6
Turbo 200 in parallel	200	209	450	420	492	225	220	240	306	190	15,2
Turbo 250 in parallel	250	257	580	520	625	287	270	290	398	240	22,5
Turbo 315 in parallel	315	323	690	670	740	366	335	355	465	340	28,4