

Catalogue No: ZS125GJ450

T2 ELCM MCCB 65kA 30mA 3A 4P 50A

Power Distribution and Protection > Circuit Breakers > Moulded Case Circuit Breakers > Terasaki TemBreak 2 Moulded Case Circuit Breakers > TemBreak 2 125 AF > ZS Earth Leakage 125 AF 65kA



Representative Photo Only
(actual product may vary based on configuration selections)

T2 ELCB 65KA 50A 30MA - 3A 4P

- Wide range of fault interruption ratings from 25 to 200kA to cater for a wide spectrum of applications
- MCCB sizes available from 16 to 1600A with various common frames and common accessories
- Customer fit accessories available to enable quick and easy configuration
- Basic or Advanced trip units such AC/DC thermal magnetic, AC electronic, metering and communications types are available
- The range complies with AS/NZS IEC 60947-2

SPECIFICATIONS

Product Series	TemBreak 2 ELCB (ZS)
Component Type MCCB	AC MCCB
Rated Frequency	50 / 60 Hz
Ue, Rated Operational Voltage, AC, max	525 V AC
In, Rated Current at 45°C	50 A @45°C
Ics, Rated Service Short-Circuit Breaking Capacity, DC	100 % Icu
Ics, Rated Service Short-Circuit Breaking Capacity, AC (IEC 60947)	55 % Icu
Ics, Rated Service Short-Circuit Breaking Capacity, 525V AC	22 kA
Icu, Rated Ultimate Short-Circuit Breaking Capacity, 220/240V AC	85 kA @220/240VAC
Icu, Rated Ultimate Short-Circuit Breaking Capacity, 400/415V AC	65 kA @400/415VAC
Icu, Rated Ultimate Short-Circuit Breaking Capacity, 440V AC	50 kA @440VAC
Icu, Rated Ultimate Short-Circuit Breaking Capacity, 525V AC	25 kA @525VAC
Uimp, Impulse Withstand Voltage	8 kV
Frame Size	125 AF size
Poles	4P
Number of Poles	4
Ui, Rated Insulation Voltage	525 V (rms)
Height	155 mm
Width	120 mm
Depth	68 mm
Weight	1.4 kg
Standard Installation Method	Front Connection
Reverse Connection Of Supply Possible	Yes
Electrical Service Life at Un, In	10000 cycles
Mechanical Service Life	30000 cycles

Catalogue No: **ZS125GJ450**

T2 ELCM MCCB 65kA 30mA 3A 4P 50A

Power Distribution and Protection > Circuit Breakers > Moulded Case Circuit Breakers > Terasaki TemBreak 2 Moulded Case Circuit Breakers > TemBreak 2 125 AF > ZS Earth Leakage 125 AF 65kA



Standards Compliance	IEC 60947-2 EN 60947-2 JIS C 8201-2-1 Ann.1 AS/NZS 60947-2 NEMA AB1
Trip Unit Protection Type	Adjustable thermal, fixed magnetic
Thermal Trip Type	Adjustable type
I _r , Thermal Trip Current, Min	32 A
I _r , Thermal Trip Current, Max	50 A
Magnetic Trip Type	Fixed type
I _m , Magnetic Trip Current	600 A
I _{Δn} , Earth Leakage Trip Sensitivity Type	Selectable sensitivity
I _{Δn} , Earth Leakage Trip Sensitivity Setting Range	30mA, 100mA, 300mA, 500mA, 1A, 3A
Earth Leakage Trip Time Type	Selectable time
Earth Leakage Trip Time Setting Range @I _{Δn}	0, 60, 200, 400, 700 ms or No trip @I _{Δn}
Certifications	CE ASTA
Shipping Approvals	ABS (American Bureau of Shipping) Lloyd's Register of Shipping BV (Bureau Veritas) DNV-GL (Det Norske Veritas Germanischer Lloyd) NK (Nippon Kaiji Kyokai)

REFERENCES

IECEX Certificate	-
Supplier Declaration of Conformity:	-
Installation Guide:	-
User Manual:	-
Manufacturer Datasheet:	-
Manufacturer Catalogue & Product Selection:	-

Catalogue No: **ZS125GJ450**

T2 ELCM MCCB 65kA 30mA 3A 4P 50A

Power Distribution and Protection > Circuit Breakers > Moulded Case Circuit Breakers > Terasaki TemBreak 2 Moulded Case Circuit Breakers > TemBreak 2 125 AF > ZS Earth Leakage 125 AF 65kA

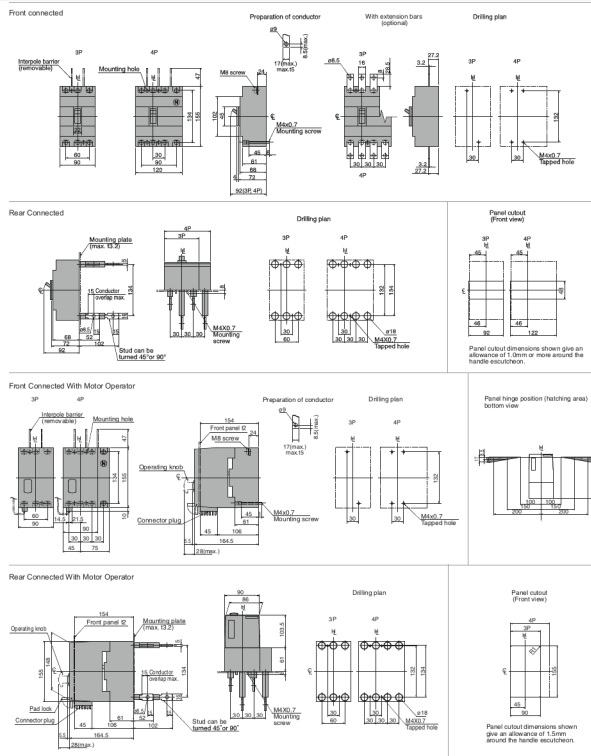

Dimension Diagram

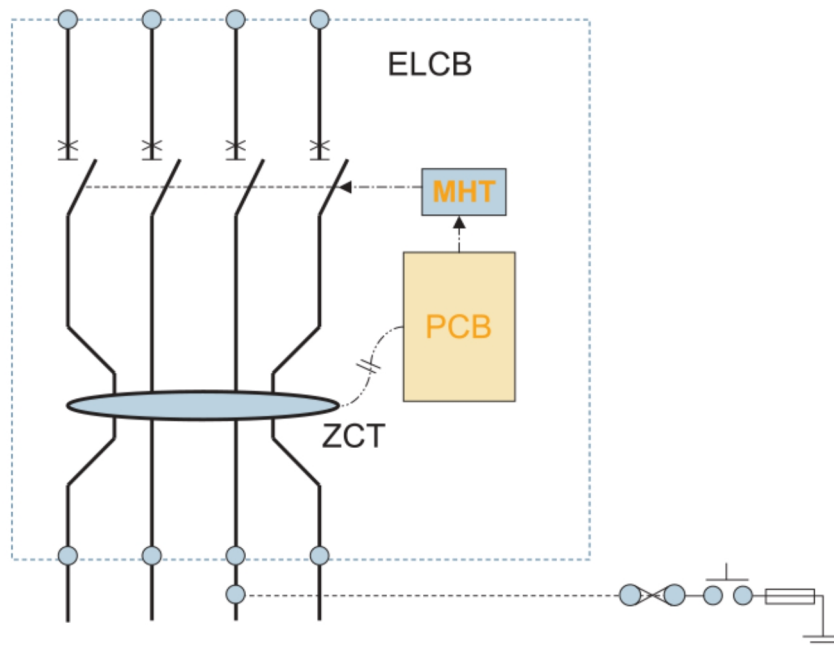

Connection / Wiring Diagram