

Catalogue No: **S125NF132**

TB2 MCCB 25kA 1P 32A THERMAL MAGNETIC

Power Distribution and Protection > Circuit Breakers > Moulded Case Circuit Breakers > Terasaki TemBreak 2 Moulded Case Circuit Breakers > TemBreak 2 125 AF > Thermal Magnetic 125 AF



Tembreak2 Moulded Case Circuit Breaker 25kA, 32 A, 1 Pole

- Wide range of fault interruption ratings from 25 to 200kA to cater for a wide spectrum of applications
- MCCB sizes available from 16 to 1600A with various common frames and common accessories
- Customer fit accessories available to enable quick and easy configuration
- Basic or Advanced trip units such AC/DC thermal magnetic, AC electronic, metering and communications types are available
- The range complies with AS/NZS IEC 60947-2

Representative Photo Only
(actual product may vary based on configuration selections)

SPECIFICATIONS

Product Series	TemBreak 2 MCCB
Component Type MCCB	AC MCCB
Rated Frequency	50 / 60 Hz
Ue, Rated Operational Voltage, AC, max	240 V AC
In, Rated Current at 45°C	32 A @45°C
Ics, Rated Service Short-Circuit Breaking Capacity, AC (IEC 60947)	52 % Icu
Icu, Rated Ultimate Short-Circuit Breaking Capacity, 240V AC	25 kA @240VAC
Uimp, Impulse Withstand Voltage	8 kV
Frame Size	125 AF size
Poles	1P
Number of Poles	1
Ui, Rated Insulation Voltage	800 V (rms)
Height	155 mm
Width	30 mm
Depth	68 mm
Weight	0.45 kg
Standard Installation Method	Front Connection
Reverse Connection Of Supply Possible	Yes
Electrical Service Life at Un, In	30000 cycles
Mechanical Service Life	30 cycles
Standards Compliance	IEC 60947-2 EN 60947-2 JIS C 8201-2-1 Ann.1 NEMA AB1 AS/NZS 60947-2
Trip Unit Protection Type	Fixed thermal, fixed magnetic
Thermal Trip Type	Fixed type
Ir, Thermal Trip Current	32 A

Catalogue No: S125NF132

TB2 MCCB 25kA 1P 32A THERMAL MAGNETIC

Power Distribution and Protection > Circuit Breakers > Moulded Case Circuit Breakers > Terasaki TemBreak 2 Moulded Case Circuit Breakers > TemBreak 2 125 AF > Thermal Magnetic 125 AF



Magnetic Trip Type	Fixed type
Im, Magnetic Trip Current	420 A
Certifications	CE ASTA
Shipping Approvals	ABS (American Bureau of Shipping) Lloyd's Register of Shipping BV (Bureau Veritas) DNV-GL (Det Norske Veritas Germanischer Lloyd) NK (Nippon Kaiji Kyokai)

REFERENCES

IECEx Certificate	-
Supplier Declaration of Conformity:	-
Installation Guide:	-
User Manual:	-
Manufacturer Datasheet:	-
Manufacturer Catalogue & Product Selection:	-

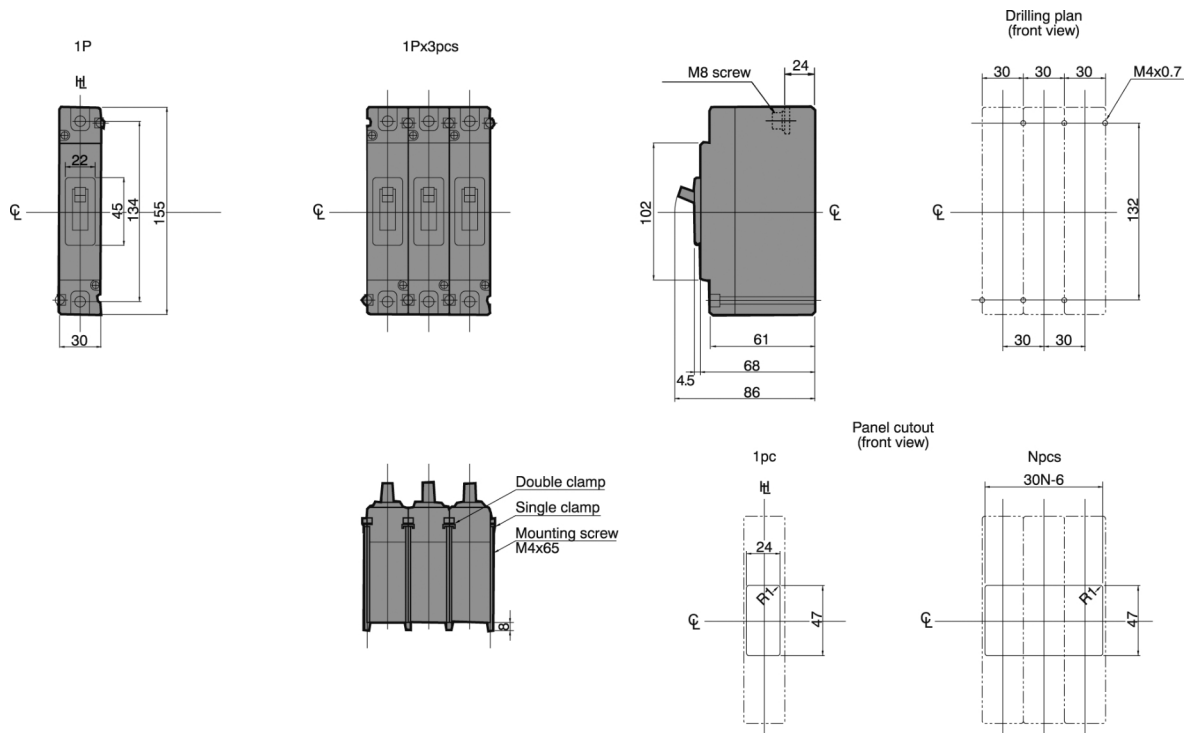

Dimension Diagram