

Representative Photo Only
(actual product may vary based on configuration selections)

Miniature Industrial Relay 8A 2 C/O 12V DC Coil w/Pb+Led+Mi

- Complete range from PCB to power relays to cover all of your switching requirements
- International certifications and approvals including CE, CSA, EAC, PCT, RINA, VDE and RoHS, providing quality assurance of a market leading product
- Compact construction allowing for most efficient use of your space

SPECIFICATIONS

Product Series	46
Component Type Timers and Control relays	Relay
Contact Configuration	2 CO
In, Rated Current	8 A
Icw, Short Time Withstand Current, 10ms (rms)	15 A, 10ms
Un, Nominal Operational Voltage, AC	250 V AC
Ue, Rated Operational Voltage, AC, max	440 V AC
Contact Breaking Capacity, DC1, 30V	6 A
Contact Breaking Capacity, DC1, 110V	0.5 A
Contact Breaking Capacity, DC1, 220V	0.15 A
Rated Load, AC-1	2000 VA
Rated Load, AC-15	350 VA
Contact Rated Power, Single Phase Motor, 230V AC	0.37 kW
Coil Type	DC
Coil Voltage, DC, Nom	12 V DC
Coil Voltage, DC, Min	8.8 V DC
Coil Voltage, DC, Max	13.2 V DC
Material, Contacts	Silver Nickel (AgNi) material
Mechanical Service Life	1000000 cycles
Electrical Service Life at Un, In	100000 cycles
Total Making Time	10 ms
Total Breaking Time	3 ms
Insulation Voltage, between Coil & Contacts	6000 V
Dielectric Strength, between open Contacts	1000 V AC
Mounting	Plug-in
Operating Temperature, Min	-40 °C min
Operating Temperature, Max	70 °C max
Height	32.8 mm

Catalogue No: **46.52.0074 12 V DC**

MINIATURE INDUSTRIAL RELAY 8A 2CO 12VDC COIL W/PB+LED+MI

Timers and Control Relays > General Purpose Relays > Electromechanical Relays > Finder Electromechanical Relays > PCB and Miniature Relays > 46 Series Miniature Industrial Relays



Width	29 mm
Depth	12.4 mm
Shock Acceleration (Max.)	20 g
Shock Duration (Max.)	4 ms
Vibration Acceleration (Max.)	20 m/s ²
Vibration Frequency, Operational (Max.)	150 Hz
Certifications	CE CCC CSA EAC GOST-R IMQ C-UR-US VDE
Shipping Approvals	Lloyd's Register of Shipping RINA (Registro Italiano Navale)

REFERENCES	
IECEX Certificate	-
Supplier Declaration of Conformity:	-
Installation Guide:	-
User Manual:	-
Manufacturer Datasheet:	-
Manufacturer Catalogue & Product Selection:	-

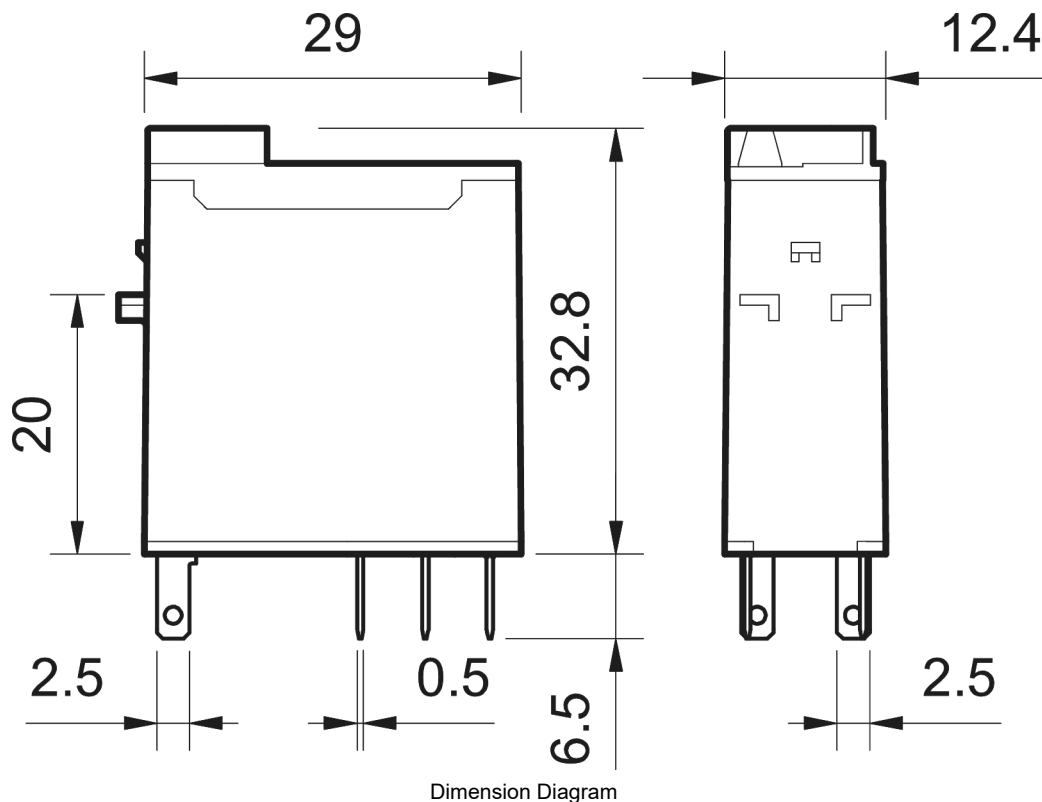

Catalogue No: **46.52.0074 12 V DC**

MINIATURE INDUSTRIAL RELAY 8A 2CO 12VDC COIL W/PB+LED+MI

Timers and Control Relays > General Purpose Relays > Electromechanical Relays > Finder Electromechanical Relays > PCB and Miniature Relays > 46 Series Miniature Industrial Relays

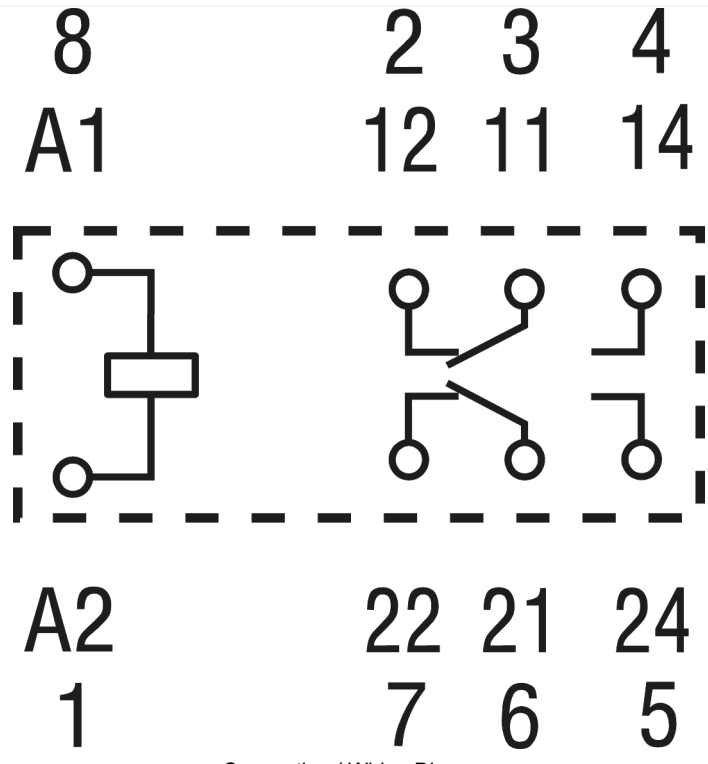

Connection / Wiring Diagram