

XCMD21F2L1

limit switch XCMD - M12 steel roller plunger -
1NC+1NO - snap - 1 m



Main

| | |
|-------------------------------|------------------------------------|
| Range of product | OsiSense XC |
| Series name | Standard format |
| Product or component type | Limit switch |
| Device short name | XCMD |
| Sensor design | Miniature |
| Body type | Fixed |
| Head type | M12 plunger head |
| Material | Metal |
| Body material | Zamak |
| Head material | Zamak |
| Fixing mode | By the head |
| Movement of operating head | Linear |
| Type of operator | Spring return roller plunger metal |
| Type of approach | Lateral approach 2 directions |
| Number of poles | 2 |
| Contacts type and composition | 1 NC + 1 NO |
| Contact operation | Snap action |

Complementary

| | |
|---|--|
| Switch actuation | By 30° cam |
| Electrical connection | Removable cable connector |
| Cable length | 1 m |
| Cable composition | 5 x 0.75 mm ² |
| Wire insulation material | PvR |
| Contacts insulation form | Zb |
| Positive opening | With |
| Positive opening minimum force | 35 N |
| Minimum force for tripping | 7 N |
| Maximum actuation speed | 10 cm/s |
| Contact code designation | B300, AC-15 (U _e = 240 V, I _e = 1.5 A) conforming to EN/IEC 60947-5-1 appendix A R300, DC-13 (U _e = 250 V, I _e = 0.1 A) conforming to EN/IEC 60947-5-1 appendix A |
| [U _i] rated insulation voltage | 300 V degree of pollution 3 conforming to UL 508 400 V degree of pollution 3 conforming to IEC 60947-5-1 300 V degree of pollution 3 conforming to CSA C22.2 No 14 |
| Resistance across terminals | <= 25 MOhm conforming to IEC 60255-7 category 3 |
| [U _{imp}] rated impulse withstand voltage | 4 kV conforming to IEC 60664 4 kV conforming to IEC 60947-1 |
| Short-circuit protection | 6 A by gG cartridge fuse |
| Electrical durability | 5000000 cycles, DC-13, 120 V, 1 W, operating rate: <= 60 cyc/mn, load factor: 0.5 conforming to IEC 60947-5-1 appendix C 5000000 cycles, DC-13, 24 V, 3 W, operating rate: <= 60 cyc/mn, load factor: 0.5 conforming to IEC 60947-5-1 appendix C 5000000 cycles, DC-13, 48 V, 2 W, operating rate: <= 60 cyc/mn, load factor: 0.5 conforming to IEC 60947-5-1 appendix C |
| Mechanical durability | 10000000 cycles |
| Width | 30 mm |
| Height | 50 mm |
| Depth | 16 mm |

The information provided in this documentation contains general descriptions and/or technical characteristics of the products contained herein. This documentation is not intended as a substitute for and is not to be used for determining suitability or reliability of these products for specific user applications. It is the duty of any such user or integrator to perform the appropriate and complete risk analysis, evaluation and testing of the products with respect to the relevant specific application or use thereof. Neither Schneider Electric Industries SAS nor any of its affiliates or subsidiaries shall be responsible or liable for misuse of the information contained herein.

Environment

| | |
|---------------------------------------|--|
| shock resistance | 25 gn (duration = 18 ms) conforming to IEC 60068-2-27 |
| vibration resistance | 5 gn (f = 10...500 Hz) conforming to IEC 60068-2-6 |
| IP degree of protection | IP68 conforming to IEC 60529 IP66 conforming to IEC 60529 IP67 conforming to IEC 60529 |
| IK degree of protection | IK06 conforming to EN 50102 |
| overvoltage category | Class I conforming to NF C 20-030 Class I conforming to IEC 61140 |
| ambient air temperature for operation | -25...70 °C |
| ambient air temperature for storage | -40...70 °C |
| protective treatment | TC |
| product certifications | CCC CSA UL |
| standards | EN/IEC 60204-1 EN/IEC 60947-5-1 UL 508 CSA C22.2 No 14 |

Offer Sustainability

| | |
|----------------------------------|---|
| Sustainable offer status | Green Premium product |
| RoHS (date code: YYWW) | Compliant - since 1002 - Schneider Electric declaration of conformity |
| REACH | Reference not containing SVHC above the threshold |
| Product environmental profile | Available |
| Product end of life instructions | Need no specific recycling operations |

Dimensions

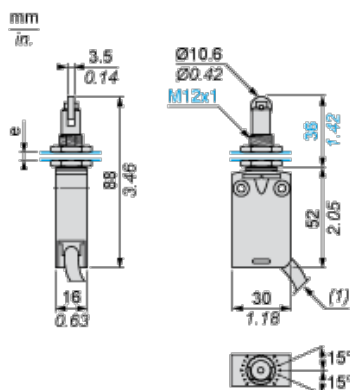

- (1) External diameter of cable 7.5 mm.
e : 8 mm max, panel cut-out \varnothing 12.5 mm.

Mounting

Sweep of Connecting Cable

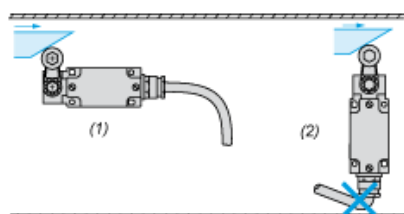

- (1) Recommended
(2) To be avoided

Panel Mounting

Mounting and Fixing Limit Switches by the Head

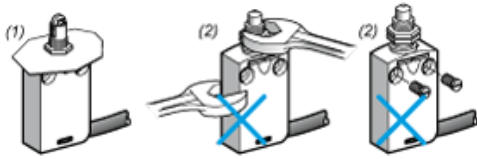

- (1) Recommended
- (2) Forbidden

Setting-up

Plunger or Multi-directional Heads

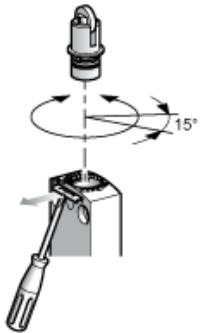

Wiring Diagram

2-pole NC + NO Snap Action

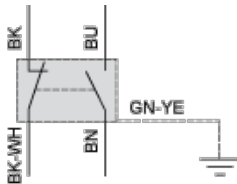

- (BK) Black
- (BK- Black White
WH)
- (BU) Blue
- (BN) Brown
- (GN- Green Yellow
YE)

Characteristics of Actuation

Switch Actuation by 30° Cam

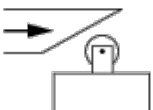

Functionnal Diagram

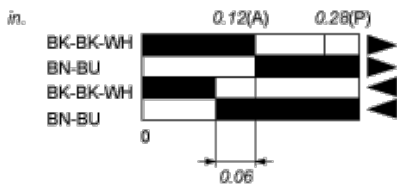
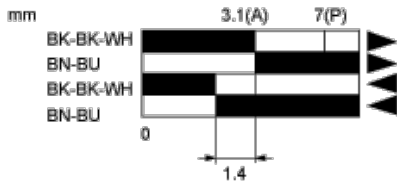

- (P) Positive opening point
- (A) Cam displacement
- (1) NC contact with positive opening operation
- (2) Closed
- (3) Open
- (4) Tripping
- (5) Resetting
- (BK) Black
- (BK- Black White
WH)
- (BU) Blue
- (BN) Brown