

ATV12H055M2

variable speed drive ATV12 - 0.55kW - 0.75hp -
200..240V - 1ph - with heat sink



Main

| | |
|------------------------------------|--|
| Range of product | Altivar 12 |
| Product or component type | Variable speed drive |
| Product destination | Asynchronous motors |
| Product specific application | Simple machine |
| Assembly style | With heat sink |
| Component name | ATV12 |
| Quantity per set | Set of 1 |
| EMC filter | Integrated |
| Built-in fan | Without |
| Network number of phases | 1 phase |
| [Us] rated supply voltage | 200...240 V - 15...10 % |
| Motor power kW | 0.55 kW |
| Motor power hp | 0.75 hp |
| Communication port protocol | Modbus |
| Line current | 8 A 200 V 6.7 A 240 V |
| Speed range | 1...20 |
| Transient overtorque | 150...170 % of nominal motor torque depending on drive rating and type of motor |
| Asynchronous motor control profile | Quadratic voltage/frequency ratio Sensorless flux vector control Voltage/frequency ratio (V/f) |
| IP degree of protection | IP20 without blanking plate on upper part |
| Noise level | 0 dB |

Complementary

| | |
|------------------------------|--|
| Supply frequency | 50/60 Hz +/- 5 % |
| Type of connector | 1 RJ45 Modbus on front face |
| Physical interface | 2-wire RS 485 Modbus |
| Transmission frame | RTU Modbus |
| Transmission rate | 4800 bit/s 9600 bit/s 19200 bit/s 38400 bit/s |
| Number of addresses | 1...247 Modbus |
| Communication service | Read device identification (43) Read holding registers (03) 29 words Write single register (06) 29 words Write multiple registers (16) 27 words Read/write multiple registers (23) 4/4 words |
| Prospective line Isc | <= 1 kA |
| Continuous output current | 3.5 A 4 kHz |
| Maximum transient current | 5.3 A 60 s |
| Speed drive output frequency | 0.5...400 Hz |
| Nominal switching frequency | 4 kHz |
| Switching frequency | 2...16 kHz adjustable 4...16 kHz with derating factor |
| Braking torque | Up to 70 % of nominal motor torque without braking resistor |
| Motor slip compensation | Adjustable |

The information provided in this documentation contains general descriptions and/or technical characteristics of the performance of the products contained herein. This documentation is not intended as a substitute for and is not to be used for determining suitability or reliability of these products for specific user applications. It is the duty of any such user or integrator to perform the appropriate and complete risk analysis, evaluation and testing of the products with respect to the relevant specific application or use thereof. Neither Schneider Electric Industries SAS nor any of its affiliates or subsidiaries shall be responsible or liable for misuse of the information contained herein.

| | |
|--|---|
| | Preset in factory |
| Output voltage | 200...240 V 1 phase |
| Electrical connection | Terminal 3.5 mm ² AWG 12 L1, L2, L3, U, V, W, PA, PC |
| Tightening torque | 0.8 N.m |
| Insulation | Electrical between power and control |
| Supply | Internal supply for reference potentiometer 5 V DC 4.75...5.25 V 10 mA overload and short-circuit protection Internal supply for logic inputs 24 V DC 20.4...28.8 V 100 mA overload and short-circuit protection |
| Analogue input number | 1 |
| Analogue input type | Configurable current AI1 0...20 mA 250 Ohm Configurable voltage AI1 0...10 V 30 kOhm Configurable voltage AI1 0...5 V 30 kOhm |
| Discrete input number | 4 |
| Discrete input type | Programmable LI1...LI4 24 V 18...30 V |
| Discrete input logic | Negative logic (sink) > 16 V < 10 V 3.5 kOhm Positive logic (source) 0...< 5 V > 11 V |
| Sampling duration | < 20 ms +/- 1 ms logic input < 10 ms analogue input |
| Linearity error | +/- 0.3 % of maximum value analogue input |
| Analogue output number | 1 |
| Analogue output type | Software-configurable voltage AO1 0...10 V 470 Ohm 8 bits Software-configurable current AO1 0...20 mA 800 Ohm 8 bits |
| Discrete output number | 2 |
| Discrete output type | Logic output LO+, LO- Protected relay output R1A, R1B, R1C 1 C/O |
| Minimum switching current | 5 mA 24 V DC logic relay |
| Maximum switching current | 2 A 250 V AC inductive cos phi = 0.4 L/R = 7 ms logic relay 2 A 30 V DC inductive cos phi = 0.4 L/R = 7 ms logic relay 3 A 250 V AC resistive cos phi = 1 L/R = 0 ms logic relay 4 A 30 V DC resistive cos phi = 1 L/R = 0 ms logic relay |
| Acceleration and deceleration ramps | Linear from 0 to 999.9 s S U |
| Braking to standstill | By DC injection 0.1...30 s |
| Protection type | Line supply overvoltage Line supply undervoltage Overcurrent between output phases and earth Overheating protection Short-circuit between motor phases Against input phase loss in three-phase Thermal motor protection via the drive by continuous calculation of I ² t |
| Frequency resolution | 0.1 Hz display unit Converter A/D, 10 bits analog input |
| Time constant | 20 ms +/- 1 ms for reference change |
| Marking | CE |
| Operating position | Vertical +/- 10 degree |
| Height | 143 mm |
| Width | 72 mm |
| Depth | 131.2 mm |
| Product weight | 0.8 kg |
| Functionality | Basic |
| Specific application | Commercial equipment |
| Variable speed drive application selection | Commercial equipment : mixer Commercial equipment : other application Textile : ironing |
| Motor power range AC-3 | 0.55...1 kW at 200...240 V 1 phase |
| Motor starter type | Variable speed drive |

Environment

| | |
|-------------------------------|--|
| electromagnetic compatibility | Electrical fast transient/burst immunity test level 4 EN/IEC 61000-4-4 Electrostatic discharge immunity test level 3 EN/IEC 61000-4-2 |
|-------------------------------|--|

Radiated radio-frequency electromagnetic field immunity test level 3 EN/IEC 61000-4-3
 Immunity to conducted disturbances level 3 EN/IEC 61000-4-6
 Surge immunity test level 3 EN/IEC 61000-4-5
 Voltage dips and interruptions immunity test EN/IEC 61000-4-11

| | |
|---------------------------------------|--|
| electromagnetic emission | Radiated emissions environment 1 category C2 EN/IEC 61800-3 2...16 kHz shielded motor cable Conducted emissions with integrated EMC filter environment 1 category C1 EN/IEC 61800-3 2, 4, 8, 12 and 16 kHz shielded motor cable <= 5 m Conducted emissions with integrated EMC filter environment 1 category C2 EN/IEC 61800-3 2...12 kHz shielded motor cable <= 5 m Conducted emissions with integrated EMC filter environment 1 category C2 EN/IEC 61800-3 2, 4 and 16 kHz shielded motor cable <= 10 m Conducted emissions with additional EMC filter environment 1 category C1 EN/IEC 61800-3 4...12 kHz shielded motor cable <= 20 m Conducted emissions with additional EMC filter environment 1 category C2 EN/IEC 61800-3 4...12 kHz shielded motor cable <= 50 m Conducted emissions with additional EMC filter environment 2 category C3 EN/IEC 61800-3 4...12 kHz shielded motor cable <= 50 m |
| product certifications | CSA C-Tick GOST NOM UL |
| vibration resistance | 1 gn EN/IEC 60068-2-6 13...200 Hz 1.5 mm peak to peak EN/IEC 60068-2-6 3...13 Hz drive unmounted on symmetrical DIN rail |
| shock resistance | 15 gn EN/IEC 60068-2-27 11 ms |
| relative humidity | 5...95 % without condensation IEC 60068-2-3 5...95 % without dripping water IEC 60068-2-3 |
| ambient air temperature for storage | -25...70 °C |
| ambient air temperature for operation | 40...60 °C with current derating 2.2 % per °C -10...40 °C protective cover from the top of the drive removed |
| operating altitude | <= 1000 m without derating > 1000...2000 m with current derating 1 % per 100 m |

Offer Sustainability

| | |
|----------------------------------|---|
| Sustainable offer status | Green Premium product |
| RoHS (date code: YYWW) | Compliant - since 0901 - Schneider Electric declaration of conformity |
| REACH | Reference not containing SVHC above the threshold |
| Product environmental profile | Available |
| Product end of life instructions | Available |

Dimensions

Drive without EMC Conformity Kit

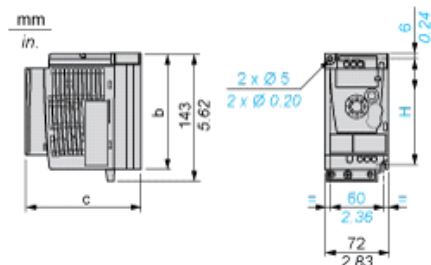

Dimensions in mm

| b | c | H |
|-----|-------|-----|
| 130 | 131.2 | 120 |

Dimensions in in.

| b | c | H |
|------|------|------|
| 5.12 | 5.16 | 4.72 |

Drive with EMC Conformity Kit

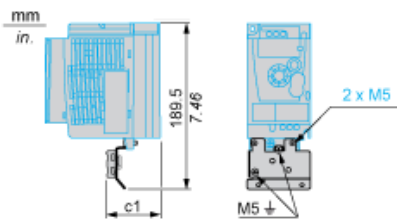

Dimensions in mm

c1

63

Dimensions in in.

c1

2.48

Mounting Recommendations

Clearance for Vertical Mounting

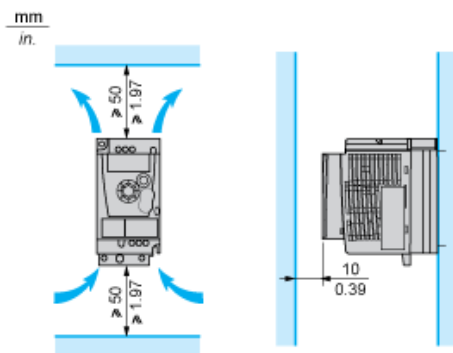

Mounting Type A

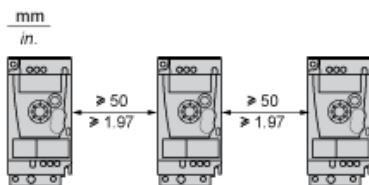

Mounting Type B

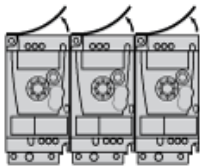

Remove the protective cover from the top of the drive.

Mounting Type C

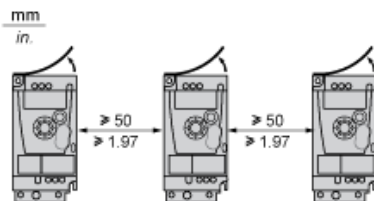

Remove the protective cover from the top of the drive.

Single-Phase Power Supply Wiring Diagram

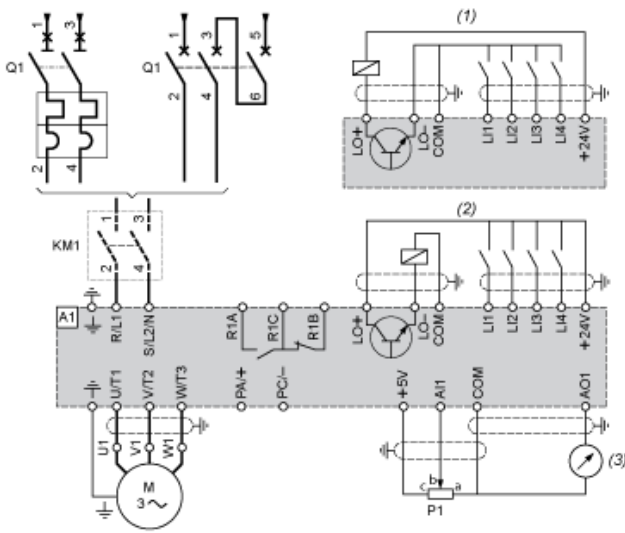

A1 Drive

KM1 Contactor (only if a control circuit is needed)

P1 2.2 kΩ reference potentiometer. This can be replaced by a 10 kΩ potentiometer (maximum).

Q1 Circuit breaker

(1) Negative logic (Sink)

(2) Positive logic (Source) (factory set configuration)

(3) 0...10 V or 0...20 mA

Recommended Schemes

2-Wire Control for Logic I/O with Internal Power Supply

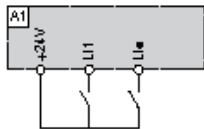

LI1 : Forward

LI• : Reverse

A1 : Drive

3-Wire Control for Logic I/O with Internal Power Supply

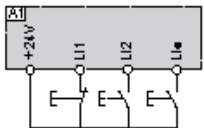

LI1 : Stop

LI2 : Forward

LI• : Reverse

A1 : Drive

Analog Input Configured for Voltage with Internal Power Supply

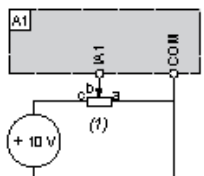

(1) 2.2 kΩ...10 kΩ reference potentiometer

A1 : Drive

Analog Input Configured for Current with Internal Power Supply



(2) 0-20 mA 4-20 mA supply

A1 : Drive

Connected as Positive Logic (Source) with External 24 vdc Supply

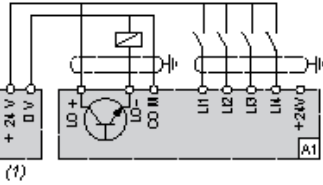

(1) 24 vdc supply

A1 : Drive

Connected as Negative Logic (Sink) with External 24 vdc supply



(1) 24 vdc supply

A1 : Drive

Torque Curves

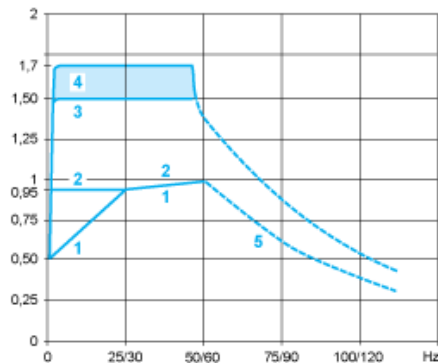

- 1 : Self-cooled motor: continuous useful torque (1)
- 2 : Force-cooled motor: continuous useful torque
- 3 : Transient overtorque for 60 s
- 4 : Transient overtorque for 2 s
- 5 : Torque in overspeed at constant power (2)

- (1) For power ratings ≤ 250 W, derating is 20% instead of 50% at very low frequencies.
- (2) The nominal motor frequency and the maximum output frequency can be adjusted from 0.5 to 400 Hz. The mechanical overspeed capability of the selected motor must be checked with the manufacturer.

Our Proposal: Circuit Breaker + Contactor + Drive for Motor Power 0,55 kW and 200 VAC

| Motor Power (kW) | Icu (kA) | Breaker | Contactors (*) | Motor Starter |
|------------------|----------|---------|----------------|---------------|
| | | | | |

| | | | | |
|------|-------|---|--|--|
| 0,55 | > 100 |  GV2ME14 |  LC1K0910P7 |  ATV12H055M2 |
|------|-------|---|--|--|

Non contractual pictures.

(*) You can select the contactor proposed or variants. Please consider examples hereafter or follow the link to the complete offer.

| Motor Power kW | Coil voltage VAC - 50/60 Hz | 24 | 48 | 110 | 115 | 220 | 230 | 400 | Other |
|-------------------|--------------------------------|----|----|-----|-----|-----|-----|-----|----------------|
| 0,55 | LC1K0910 .. | B7 | E7 | F7 | FE7 | M7 | P7 | V7 | Complete Offer |

| Motor Power kW | Coil voltage VDC - U 0.75...1.25 Uc | 24 | 48 | Other |
|-------------------|--|----|----|----------------|
| 0,55 | LP1K0910 .. | BD | ED | Complete Offer |

| Motor Power kW | Coil voltage Low Consumption VDC - U 0.8...1.25 Uc | 24 | 110 | Other |
|-------------------|--|-----|-----|----------------|
| 0,55 | LP4K0910 .. | BW3 | FW3 | Complete Offer |