



Product Description

MASTERColour CDM-TC Elite

Single-ended, compact size, high-efficiency Ceramic Metal Halide discharge lamp

Benefits

- Outstanding rendering of displayed merchandise due to high colour rendering (Ra 90) in combination with high lumen output; best offer in the market for 'enhancing merchandize'
- Excellent colour quality remains stable over lifetime
- Light output over lifetime maintains display brightness
- High efficacy and long lifetime for lowest operating costs and low heat generation
- Relatively low heat generation enhances comfort for shoppers and staff
- UV Block for reduced fading risk of merchandize
- Allows design of very compact luminaires with high beam intensities

Features

- Crisp white light
- Excellent colour rendering (Ra 90)
- Reliable lifetime performance
- Stable colour performance during lifetime
- Increased light output compared with regular MASTERColour lamps
- Improved maintenance compared with regular MASTERColour lamps
- Burning position for

- CDM Elite-TC 35W: vertical +/- 60 degrees
- CDM Elite-TC 70W: universal

Application

- Accent and display lighting with a sparkling effect, excellent solution for Retail
- General and decorative lighting

Warnings and Safety

- Use only in totally enclosed luminaire, even during testing (IEC61167, IEC 62035, IEC60598)
- The luminaire must be able to contain hot lamp parts if the lamp ruptures
- Use only with electronic control gear
- Control gear must include end-of-life protection (IEC61167, IEC 62035)

Related products

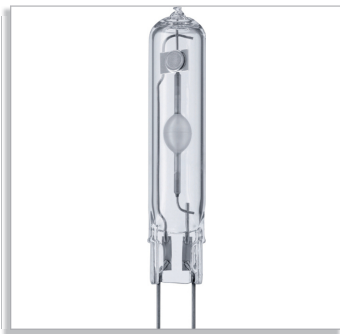

CDM-TC Elite 35W /930 /942

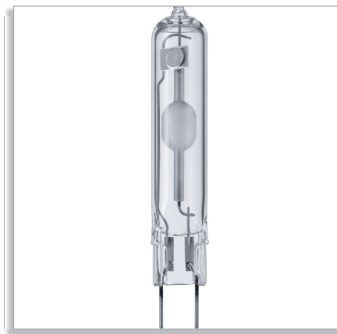

CDM-TC Elite 70W /930 /942 + CDM-TC Fresh 70W



CDM-TC Elite 50W /930 + CDM-TC Fresh 50W

Dimensional drawing

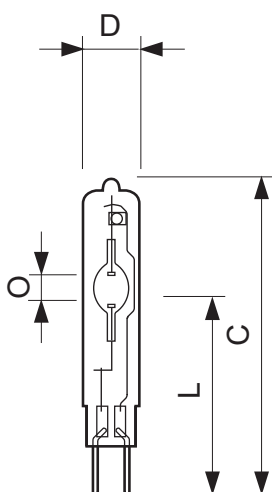

CDM-TC Elite

Product	C (Max)	D (Max)	L (Min)	L (Norm)	L (Max)	O (Norm)
CDM-TC Elite 50W/942 G8.5	85	15	51	52	53	6

Dimensional drawing

CDM-TC ACCENT 35W/930 G8.5	85	15	51	52	53	4.8
CDM-TC ACCENT 70W/930 G8.5	85	15	51	52	53	7.15
CDM-TC ACCENT 50W/930 G8.5	85	15	51	52	53	6
CDM-TC ACCENT 35W/942 G8.5	85	15	51	52	53	4.8
CDM-TC ACCENT 70W/942 G8.5	85	15	51	52	53	7.15

General Characteristics

Order code	Full product name	Bulb	Bulb Finish	Cap-Base	Burning Position	Life to 50% failures EL	Life to 5% failures EL	Life to 20% failures EL	Life to 10% failures EL
911497 00	MASTERColour CDM-TC Elite 35W/930 G8.5 1CT	T14	Clear	G8.5	any	15000 hr	9000 hr	12000 hr	10000 hr
163664 00	MASTERColour CDM-TC Elite 35W/942 G8.5 1CT	T14	Clear	G8.5	any	15000 hr	9000 hr	12000 hr	10000 hr
911534 00	MASTERColour CDM-TC Elite 70W/930 G8.5 1CT	T14	Clear	G8.5	any	15000 hr	9000 hr	12000 hr	10000 hr
163688 00	MASTERColour CDM-TC Elite 70W/942 G8.5 1CT	T14	Clear	G8.5	any	15000 hr	9000 hr	12000 hr	10000 hr
201632 00	MASTERColour CDM-TC Elite 50W/942 G8.5 1CT	T14	Clear	G8.5	any	15000 hr	9000 hr	12000 hr	10000 hr
930627 00	MASTERColour CDM-TC Elite 50W/930 G8.5 1CT	T14	Clear	G8.5	any	15000 hr	9000 hr	12000 hr	10000 hr

Installation diagrams

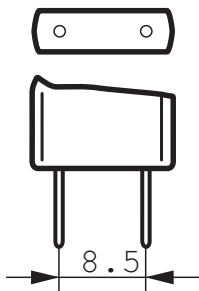

G8.5

Installation diagrams

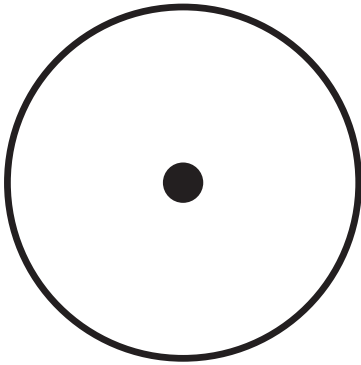

any

Light Technical Characteristics (1/2)

Order code	Full product name	Colour Code	Colour Designation	Lamp Luminous Flux EL	Chromaticity Coordinate X	Chromaticity Coordinate Y	Colour Rendering Index	Lamp Luminous Efficacy EL	Colour Temperature	Lumen Maintenance EL 10000h	Lumen Maintenance EL 5000h
911497 00	MASTERColour CDM-TC Elite 35W/930 G8.5 1CT	930	Warm white	4000 Lm	0.435 -	0.396 -	87 (min), 90 (nom) Ra8	102 Lm/W	3000 K	83 %	88 %
163664 00	MASTERColour CDM-TC Elite 35W/942 G8.5 1CT	942	Cool White	3700 Lm	0.371 -	0.366 -	85 (min), 88 (nom) Ra8	95 Lm/W	4200 K	77 %	86 %
911534 00	MASTERColour CDM-TC Elite 70W/930 G8.5 1CT	930	Warm white	7650 Lm	0.435 -	0.396 -	87 (min), 90 (nom) Ra8	104 Lm/W	3000 K	83 %	88 %
163688 00	MASTERColour CDM-TC Elite 70W/942 G8.5 1CT	942	Cool White	7400 Lm	0.371 -	0.366 -	87 (min), 90 (nom) Ra8	101 Lm/W	4200 K	77 %	86 %
201632 00	MASTERColour CDM-TC Elite 50W/942 G8.5 1CT	942	Cool White	5000 Lm	0.375 -	0.367 -	90 Ra8	100 Lm/W	4200 K	77 %	86 %
930627 00	MASTERColour CDM-TC Elite 50W/930 G8.5 1CT	930	Warm white	5400 Lm	0.435 -	0.396 -	87 (min), 90 (nom) Ra8	106 Lm/W	3000 K	83 %	88 %

Light Technical Characteristics (2/2)

Order code	Full product name	Lumen Maintenance EL 2000h	Lumen Maintenance EL 12000h	Design Mean Lumens EL
911497 00	MASTERColour CDM-TC Elite 35W/930 G8.5 1CT	94 %	82 %	3300 Lm
163664 00	MASTERColour CDM-TC Elite 35W/942 G8.5 1CT	92 %	76 %	3200 Lm
911534 00	MASTERColour CDM-TC Elite 70W/930 G8.5 1CT	94 %	82 %	6650 Lm
163688 00	MASTERColour CDM-TC Elite 70W/942 G8.5 1CT	92 %	76 %	6500 Lm

Order code	Full product name	Lumen Maintenance EL 2000h	Lumen Maintenance EL 12000h	Design Mean Lumens EL
201632 00	MASTERColour CDM-TC Elite 50W/942 G8.5 1CT	92 %	76 %	4100 Lm
930627 00	MASTERColour CDM-TC Elite 50W/930 G8.5 1CT	94 %	%	4750 Lm

Light technical

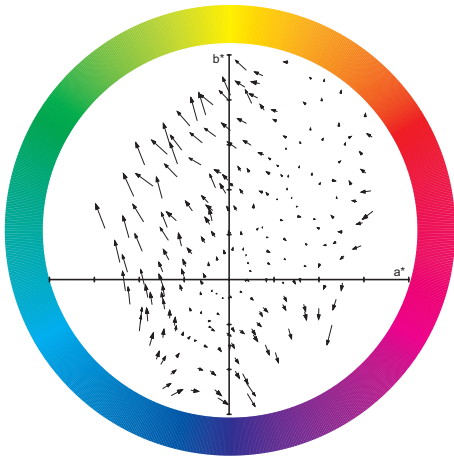

CDM-TC Elite 35W /930

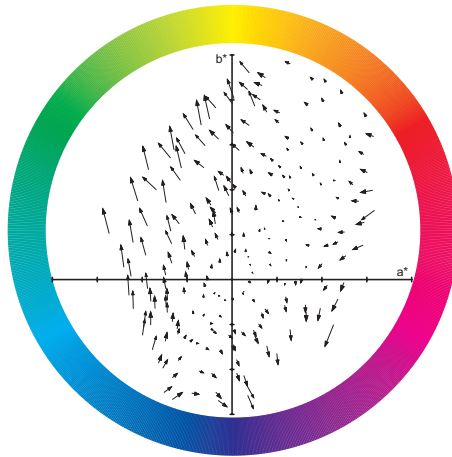

CDM-TC Elite 70W /930

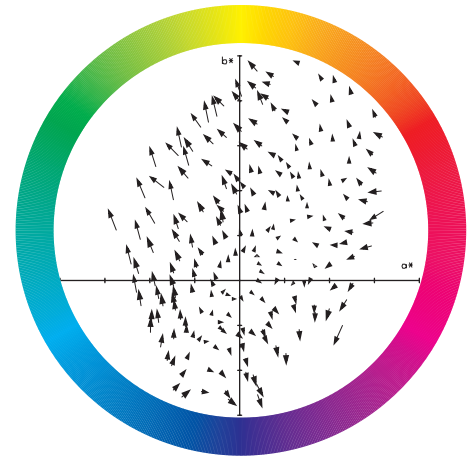

CDM-TC Elite 50W /930

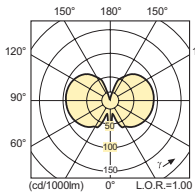

CDM-TC Elite 50W /942

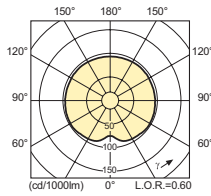

CDM-TC Elite 35W /842, /930, /942

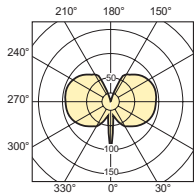

CDM-TC Elite 70W /930, /942

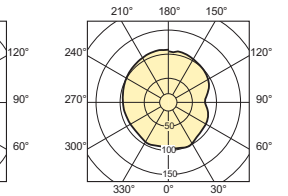
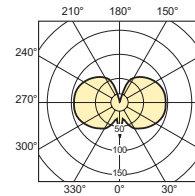
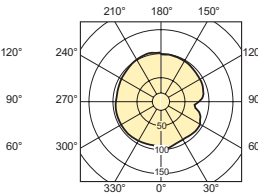

Electrical Characteristics

Order code	Full product name	Lamp Wattage	Lamp Wattage EL	Lamp Voltage	Lamp Current EL	Dimmable	Order code	Full product name	Lamp Wattage	Lamp Wattage EL	Lamp Voltage	Lamp Current EL	Dimmable
91149700	MASTERColour CDM-TC Elite 35W/930 G8.5 1CT	35 W	39 W	84 V	0.470 A	no	20163200	MASTERColour CDM-TC Elite 50W/942 G8.5 1CT	50 W	50 W	85 V	0.58 A	no
16366400	MASTERColour CDM-TC Elite 35W/942 G8.5 1CT	35 W	39 W	84 V	0.5 A	no	93062700	MASTERColour CDM-TC Elite 50W/930 G8.5 1CT	50 W	50 W	90 V	0.59 A	no
91153400	MASTERColour CDM-TC Elite 70W/930 G8.5 1CT	70 W	73 W	84 V	0.89 A	no							
16368800	MASTERColour CDM-TC Elite 70W/942 G8.5 1CT	70 W	73 W	84 V	0.89 A	no							

Performance diagrams

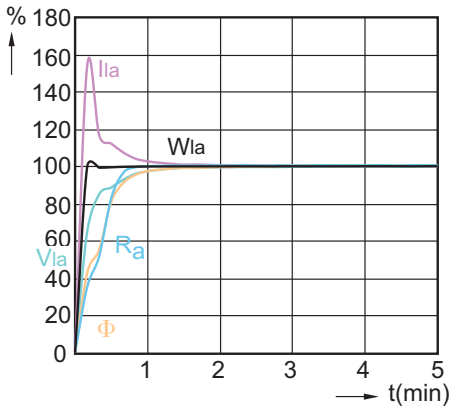

CDM-TC Elite 50W /942

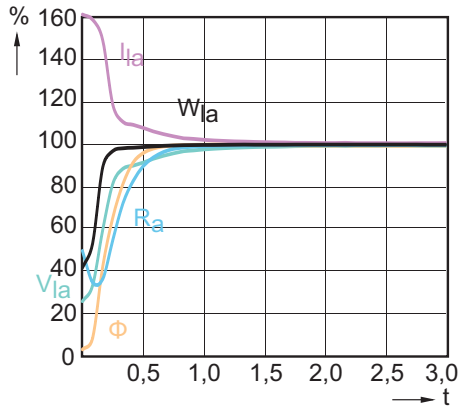

CDM-TC Elite 35W /842, /930, /942

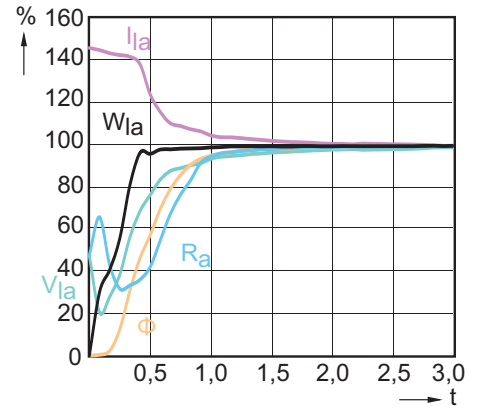

CDM-TC Elite 70W /930, /942

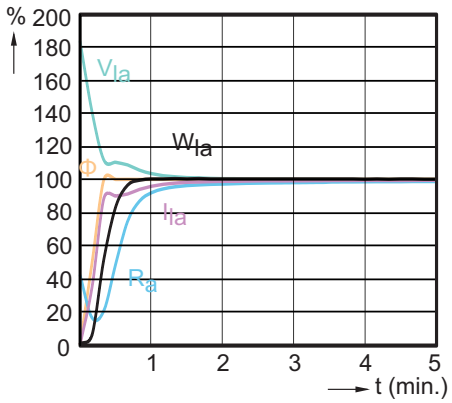

CDM-TC Elite 50W /930

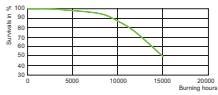

CDM-TC Elite 50W / 930, /942

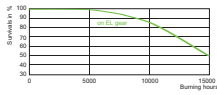

CDM-TC Elite 35W /930

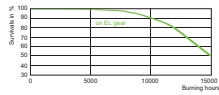

CDM-TC Elite 70W /930

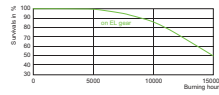

CDM-TC Elite 35W / 842, /942

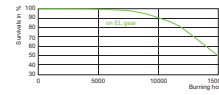

CDM-TC Elite 70W /942

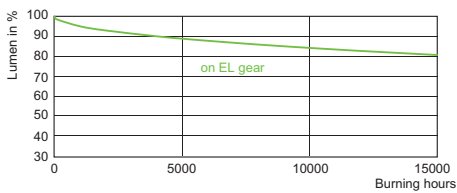

CDM-TC Elite 50W, 70W /942

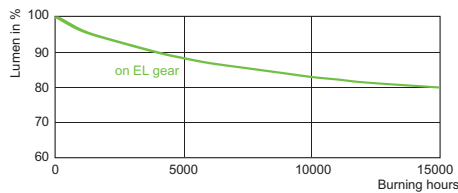

CDM-TC Elite 35W & 70W /930

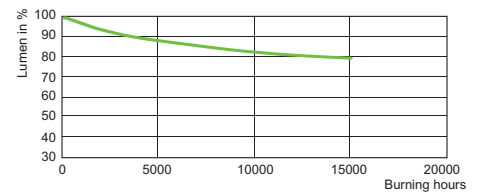

CDM-TC Elite 50W /930

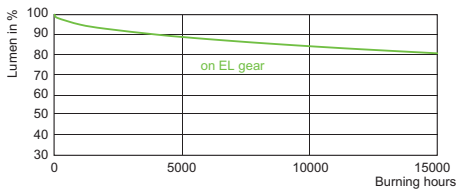

CDM-TC Elite 35W /842, /942

Performance diagrams

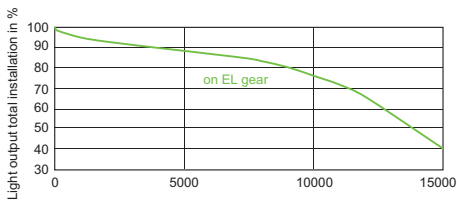

CDM-T Elite 50W, 70W /942

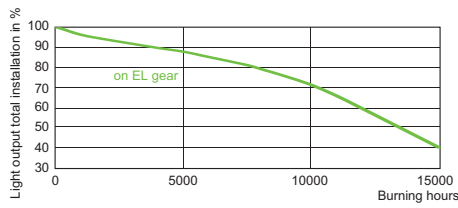

CDM-TC Elite 35W /930

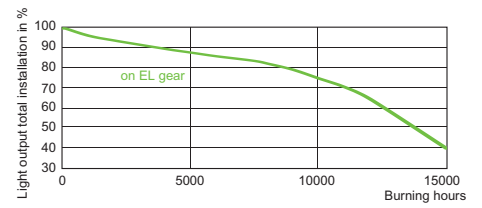

CDM-TC Elite 70W /930

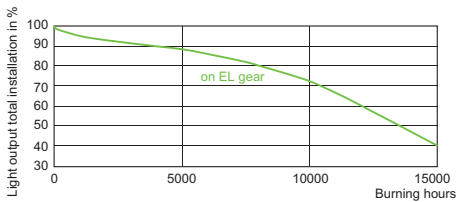

CDM-T Elite 35W /842, /942

Environmental Characteristics

Order code	Full product name	Mercury (Hg) Content
911497 00	MASTERColour CDM-TC Elite 35W/930 G8.5 1CT	4.7 mg
163664 00	MASTERColour CDM-TC Elite 35W/942 G8.5 1CT	4.3 mg
911534 00	MASTERColour CDM-TC Elite 70W/930 G8.5 1CT	6.6 mg
163688 00	MASTERColour CDM-TC Elite 70W/942 G8.5 1CT	6 mg
201632 00	MASTERColour CDM-TC Elite 50W/942 G8.5 1CT	5.4 mg
930627 00	MASTERColour CDM-TC Elite 50W/930 G8.5 1CT	6.4 mg

Luminaire Design Requirements

Order code	Full product name	Bulb Temperature
911497 00	MASTERColour CDM-TC Elite 35W/930 G8.5 1CT	500 (max) C
163664 00	MASTERColour CDM-TC Elite 35W/942 G8.5 1CT	500 (max) C
911534 00	MASTERColour CDM-TC Elite 70W/930 G8.5 1CT	550 (max) C
163688 00	MASTERColour CDM-TC Elite 70W/942 G8.5 1CT	500 (max) C
201632 00	MASTERColour CDM-TC Elite 50W/942 G8.5 1CT	550 (max) C
930627 00	MASTERColour CDM-TC Elite 50W/930 G8.5 1CT	550 (max) C



© 2012 Koninklijke Philips Electronics N.V.
All rights reserved.

Specifications are subject to change without notice. Trademarks are the property of Koninklijke Philips Electronics N.V. or their respective owners.

www.philips.com/lighting

2012, August 25
data subject to change