

**Arteor™ signature :**  
**Woven metal plates for Italian and US standard**

**Cat. No(s):** 576 417/427/437/447/457/467  
576 617/627/637/647/657/667  
576 737

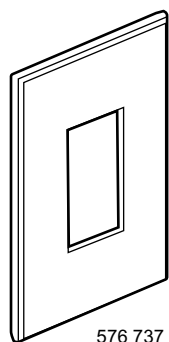

576 737

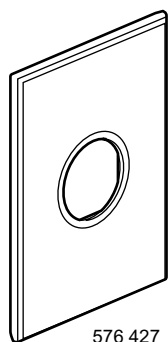

576 427

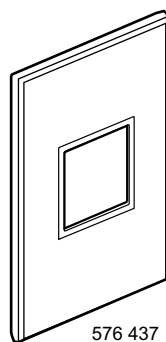

576 437

**CONTENTS**



Page

1. Use.....	1
2. Range.....	1-2
3. Overall dimensions.....	2
4. Mounting.....	3
5. Technical characteristics.....	3
6. Cleaning.....	3
7. Special use.....	3

**1. USE**

Plates for covering mechanisms.

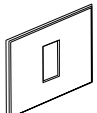
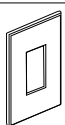
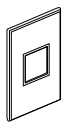
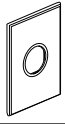
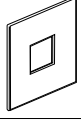
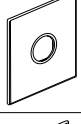
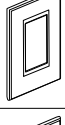
**2. RANGE**

	Designation	Cat. No.	Number of modules	Fixing method	Weight (g)
	1 module plate square (2'' x 4'')	576 417	1	With clips	138
	1 module plate square vertical (2'' x 4'')	576 737	1	With clips	138
	2 modules plate square (2'' x 4'')	576 437	2	With clips	134
	2 modules plate round (2'' x 4'')	576 427	2	With clips	136
	2 modules plate square (4'' x 4'')	576 627	2	With clips	158
	2 modules plate round (4'' x 4'')	576 617	2	With clips	160
	3 modules plate square (2'' x 4'')	576 457	3	With clips	126
	3 modules plate round (2'' x 4'')	576 447	3	With clips	128

**2. RANGE (suite)**

	Designation	Cat. No.	Number of modules	Fixing method	Weight (g)
	3 modules plate square (4" x 4")	576 647	3	With clips	150
	3 modules plate round (4" x 4")	576 637	3	With clips	152
	4 modules plate square (4" x 4")	576 657	4	With clips	142
	Plate for 4 modules socket	576 467		With clips	151
	2 x 3 modules plate square (4" x 4")	576 677	2 x 3	With clips	140
	2 x 3 modules plate round (4" x 4")	576 667	2 x 3	With clips	150

**3. OVERALL DIMENSIONS**

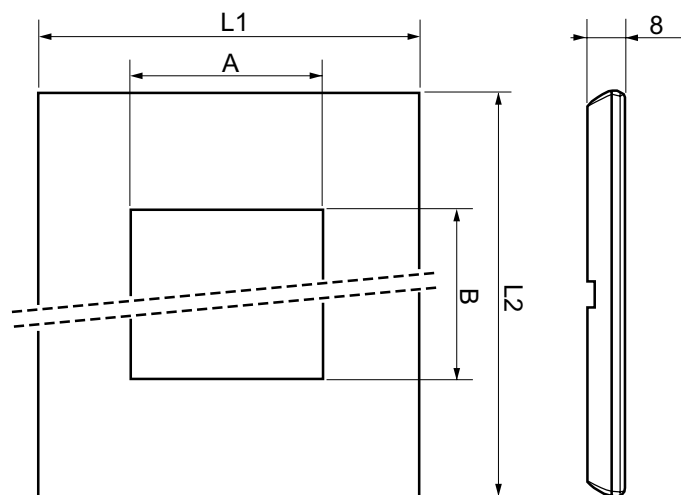

**3. OVERALL DIMENSIONS (suite)**

Cat. No.	L1	L2	A	B
576 417	127	92	22.8	45.4
576 427	92	127	Ø 45.4	
576 437			45.4	45.4
576 447				68
576 457				90
576 467				
576 617	127	127	Ø 45.4	
576 627			45.4	45.4
576 637			68	
576 647			90	
576 657			2 x 45.4	
576 667				
576 677				
576 737	92		22.8	45.4

**Arteor™ signature :**  
**Woven metal plates for Italian and US standard**

Cat. No(s).: 576 417/427/437/447/457/467  
576 617/627/637/647/657/667  
576 737

#### **4. MOUNTING**

The plates clip on in notches onto screw-type or claw-type mounting supports (notches are used for thickness compensation. E.g.: wall paper). Easy to remove with a screwdriver.  
No flatness defect of more than 1.5 mm in a periphery of 10 cm around the installed flush box.  
Protection film must be removed only once site work is fully completed.

#### **5. TECHNICAL CHARACTERISTICS**

##### **5.1 Mechanical characteristics**

Impact tests: IK 04

##### **5.2 Material characteristics**

Front plate: stainless steel  
Under plate: polycarbonate  
Surround: chromed zamac

##### **5.3 Climatic characteristics**

Storage temperatures: - 10° C to + 70° C  
Operating temperatures: - 5° C to + 50° C

#### **6. CLEANING**

Do not use cleaning products.  
Clean with a dry cloth.

#### **7. SPECIAL USE**

Arteor plates must not be painted.