

SR2D101FU

compact smart relay Zelio Logic - 10 I O - 100..240 V AC - no clock - no display

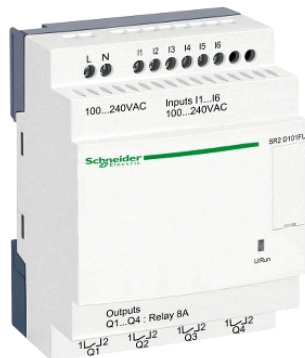

Main

Range of product	Zelio Logic
Product or component type	Compact smart relay

Complementary

Local display	Without
Number of control scheme lines	240 with ladder programming
Cycle time	6...90 ms
Backup time	10 years at 25 °C
Clock drift	6 s/month at 25 °C 12 min/year at 0...55 °C
Checks	Program memory on each power up
[Us] rated supply voltage	100...240 V AC
Supply voltage limits	85...264 V
Supply frequency	50/60 Hz
Supply current	30 mA at 240 V (without extension) 80 mA at 100 V (without extension)
Power consumption in VA	7 VA without extension
Isolation voltage	1780 V
Protection type	Against inversion of terminals (control instructions not executed)
Discrete input number	6
Discrete input voltage	100...240 V AC
Discrete input current	0.6 mA
Discrete input frequency	47...53 Hz 57...63 Hz
Voltage state 1 guaranteed	>= 79 V for discrete input
Voltage state 0 guaranteed	<= 40 V for discrete input
Current state 1 guaranteed	>= 0.17 mA for discrete input
Current state 0 guaranteed	<= 0.5 mA for discrete input
Input impedance	350 kOhm (discrete input)
Number of outputs	4 relay output(s)
Output voltage limits	24...250 V AC 5...30 V DC (relay output)
Contacts type and composition	NO for relay output
Output thermal current	8 A for all 4 outputs (relay output)
Electrical durability	500000 cycles AC-12 at 230 V, 1.5 A for relay output conforming to EN/IEC 60947-5-1 500000 cycles AC-15 at 230 V, 0.9 A for relay output conforming to EN/IEC 60947-5-1 500000 cycles DC-12 at 24 V, 1.5 A for relay output conforming to EN/IEC 60947-5-1 500000 cycles DC-13 at 24 V, 0.6 A for relay output conforming to EN/IEC 60947-5-1
Switching capacity in mA	>= 10 mA at 12 V (relay output)
Operating rate in Hz	0.1 Hz (at Ie) for relay output 10 Hz (no load) for relay output
Mechanical durability	10000000 cycles (relay output)
[Uimp] rated impulse withstand voltage	4 kV conforming to EN/IEC 60947-1 and EN/IEC 60664-1

The information provided in this documentation contains general descriptions and/or technical characteristics of the performance of the products contained herein. This documentation is not intended as a substitute for and is not to be used for determining suitability or reliability of these products for specific user applications. It is the duty of any such user or integrator to perform the appropriate and complete risk analysis, evaluation and testing of the products with respect to the relevant specific application or use thereof. Neither Schneider Electric Industries SAS nor any of its affiliates or subsidiaries shall be responsible or liable for misuse of the information contained herein.

Clock	Without
Response time	10 ms (from state 0 to state 1) for relay output 5 ms (from state 1 to state 0) for relay output 50 ms with ladder programming (from state 0 to state 1) for discrete input 50 ms with ladder programming (from state 1 to state 0) for discrete input 50...255 ms with FBD programming (from state 0 to state 1) for discrete input 50...255 ms with FBD programming (from state 1 to state 0) for discrete input
Connections - terminals	Screw terminals, clamping capacity: 1 x 0.2...1 x 2.5 mm ² AWG 25...AWG 14 semi-solid Screw terminals, clamping capacity: 1 x 0.2...1 x 2.5 mm ² AWG 25...AWG 14 solid Screw terminals, clamping capacity: 1 x 0.25...1 x 2.5 mm ² AWG 24...AWG 14 flexible with cable end Screw terminals, clamping capacity: 2 x 0.2...2 x 1.5 mm ² AWG 24...AWG 16 solid Screw terminals, clamping capacity: 2 x 0.25...2 x 0.75 mm ² AWG 24...AWG 18 flexible with cable end
Tightening torque	0.5 N.m
Overvoltage category	III conforming to EN/IEC 60664-1
Product weight	0.22 kg

Environment

immunity to microbreaks	<= 10 ms
product certifications	CSA C-Tick GL GOST UL
standards	EN/IEC 60068-2-27 Ea EN/IEC 60068-2-6 Fc EN/IEC 61000-4-11 EN/IEC 61000-4-12 EN/IEC 61000-4-2 level 3 EN/IEC 61000-4-3 EN/IEC 61000-4-4 level 3 EN/IEC 61000-4-5 EN/IEC 61000-4-6 level 3
IP degree of protection	IP20 (terminal block) conforming to IEC 60529 IP40 (front panel) conforming to IEC 60529
environmental characteristic	EMC directive conforming to EN/IEC 61000-6-2 EMC directive conforming to EN/IEC 61000-6-3 EMC directive conforming to EN/IEC 61000-6-4 EMC directive conforming to EN/IEC 61131-2 zone B Low voltage directive conforming to EN/IEC 61131-2
disturbance radiated/conducted	Class B conforming to EN 55022-11 group 1
pollution degree	2 conforming to EN/IEC 61131-2
ambient air temperature for operation	-20...40 °C in non-ventilated enclosure conforming to IEC 60068-2-1 and IEC 60068-2-2 -20...55 °C conforming to IEC 60068-2-1 and IEC 60068-2-2
ambient air temperature for storage	-40...70 °C
operating altitude	2000 m
altitude transport	<= 3048 m
relative humidity	95 % without condensation or dripping water

Compact and Modular Smart Relays

Mounting on 35 mm/1.38 in. DIN Rail

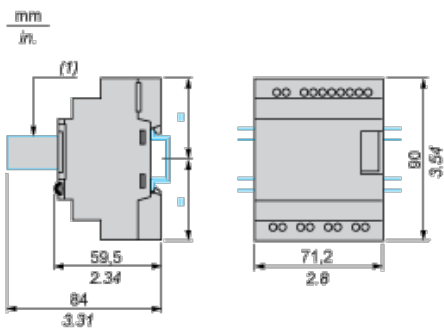

(1) With SR2USB01 or SR2BTC01

Screw Fixing (Retractable Lugs)

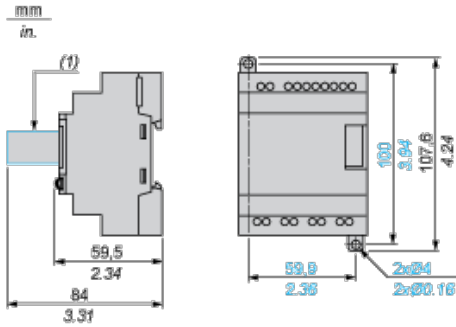

(1) With SR2USB01 or SR2BTC01

Position of Display

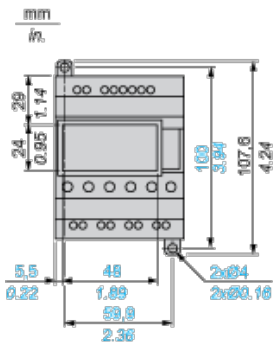

Connection of Smart Relays on AC Supply

SR***1B, SR***1FU

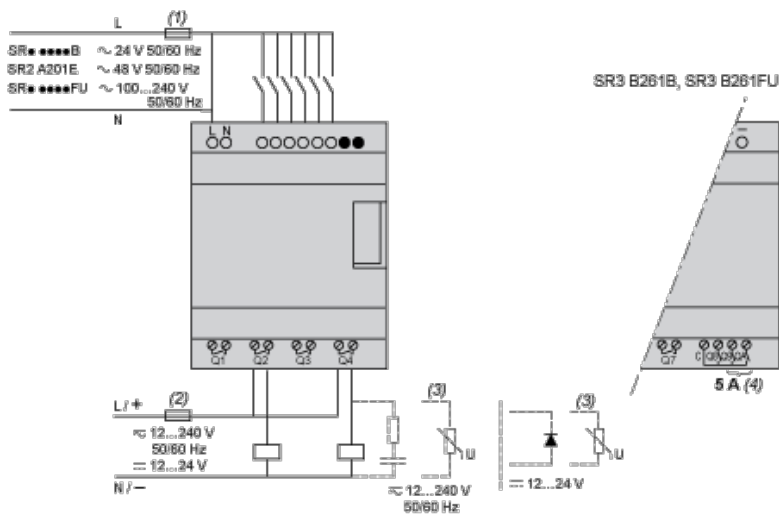

- (1) 1 A quick-blow fuse or circuit-breaker.
- (2) Fuse or circuit-breaker.
- (3) Inductive load.
- (4) Q9 and QA: 5 A (max. current in terminal C: 10 A).

With Discrete I/O Extension Module

SR3B...B + SR3XT...B, SR3B...FU + SR3XT...FU

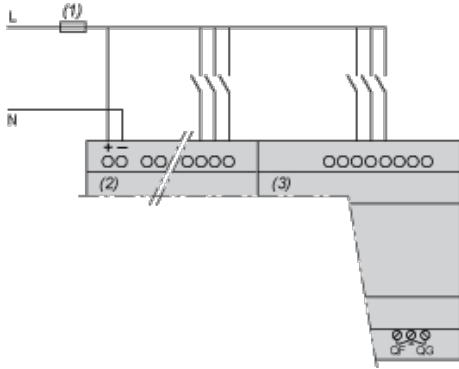

(1) 1 A quick-blow fuse or circuit-breaker.

NOTE: QF and QG: 5 A for SR3XT141..

Compact and Modular Smart Relays

Electrical Durability of Relay Outputs

(in millions of operating cycles, conforming to IEC/EN 60947-5-1)

AC-12 (1)

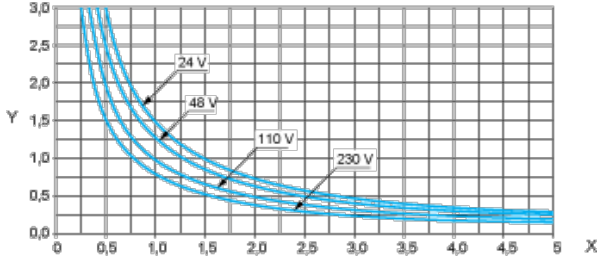

X: Current (A)

Y: Millions of operating cycles

(1) AC-12: switching resistive loads and opto-coupler isolated solid-state loads, $\cos \geq 0.9$.

AC-14 (1)

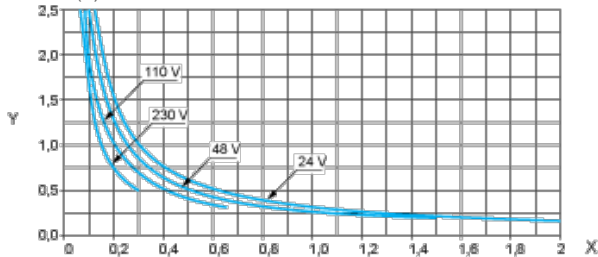

X: Current (A)

Y: Millions of operating cycles

(1) AC-14: switching small electromagnetic loads ≤ 72 VA, make: $\cos = 0.3$, break: $\cos = 0.3$.

AC-15 (1)

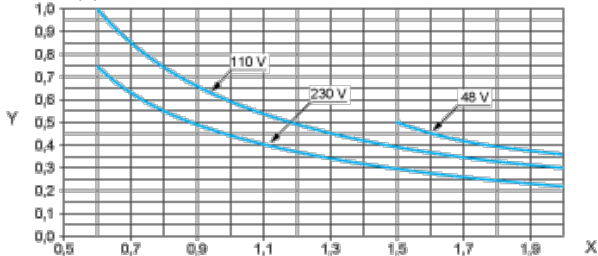

X: Current (A)

Y: Millions of operating cycles

(1) AC-15: switching electromagnetic loads ≥ 72 VA, make: $\cos = 0.7$, break: $\cos = 0.4$.