

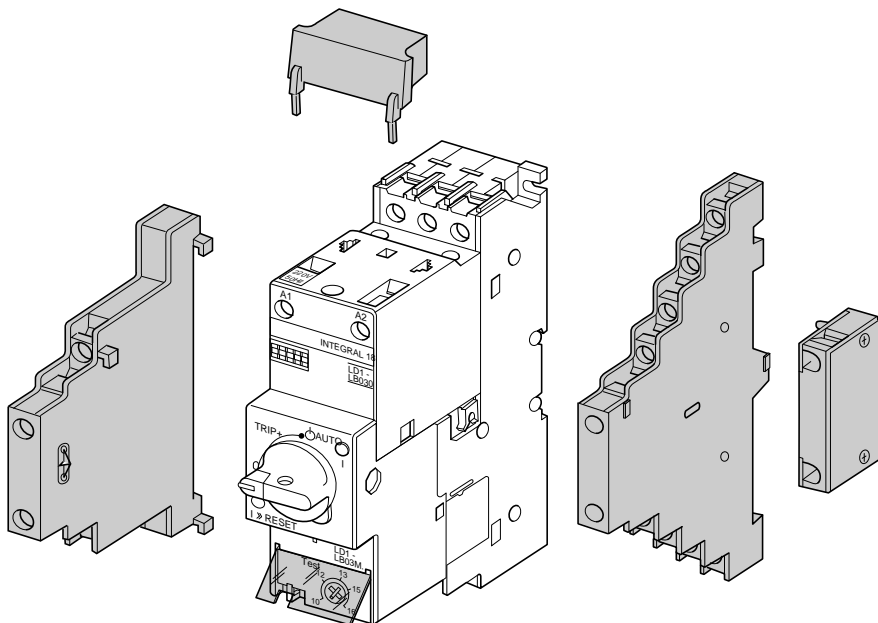







Telemecanique integral 18

LA1/LA9



								C N.m	C lb.in
[mm ²]	[mm ²]	[mm ²]	[mm ²]	[mm ²]	[mm ²]	Philips			
LA1LB	1...2,5 + 1...2,5	1...2,5	1...2,5 + 1...2,5	1...2,5	1...2,5 + 1...2,5	Ø 6	2	1,2	10



The lateral add-on blocks are mounted before the module
 Monter les additifs latéraux avant le module
 Die seitlichen Zusatzteile vor dem Modul einbauen
 Montar los aditivos laterales antes del módulo
 Montare gli additivi laterali prima del modulo
 Montar os aditivos laterais antes do módulo

integral 18

LA1/LA9

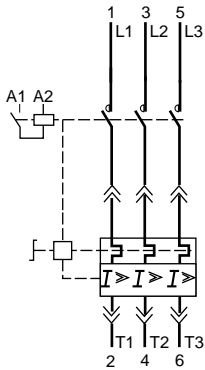

LA1-LB015

LA1-LB017

LA1-LB019

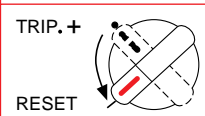
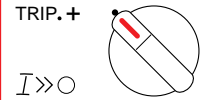
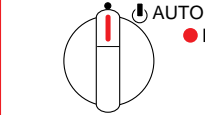
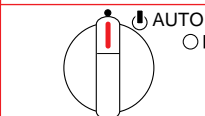
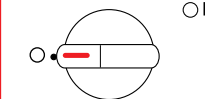
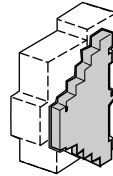
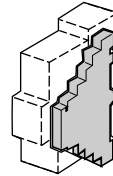
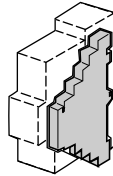

integral 18

LA1/LA9

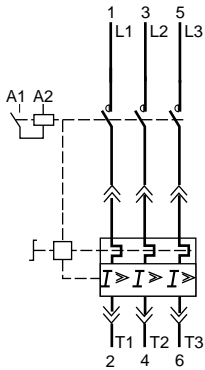

	LA1-LB001	LA1-LB031	LA1-LB0311	LA1-LB034	LA1-LB0341	
	AUTO + 0 	AUTO + 0 	AUTO + 0 	I >> 	AUTO + 0 	I >>

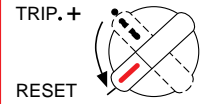
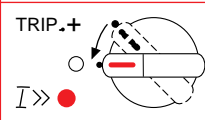
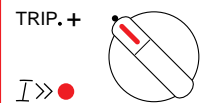
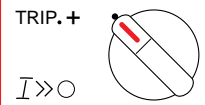
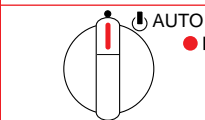
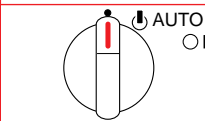
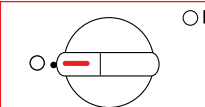

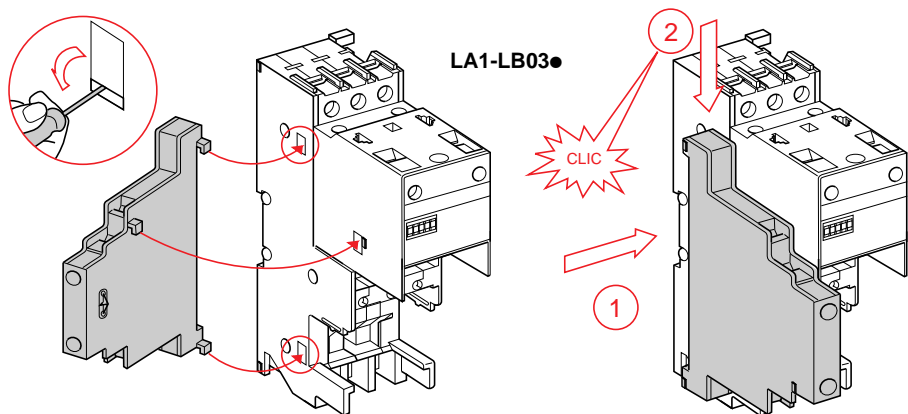
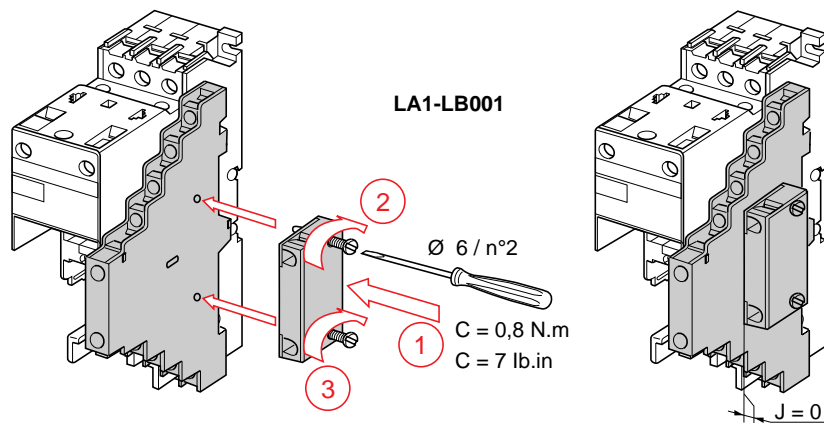
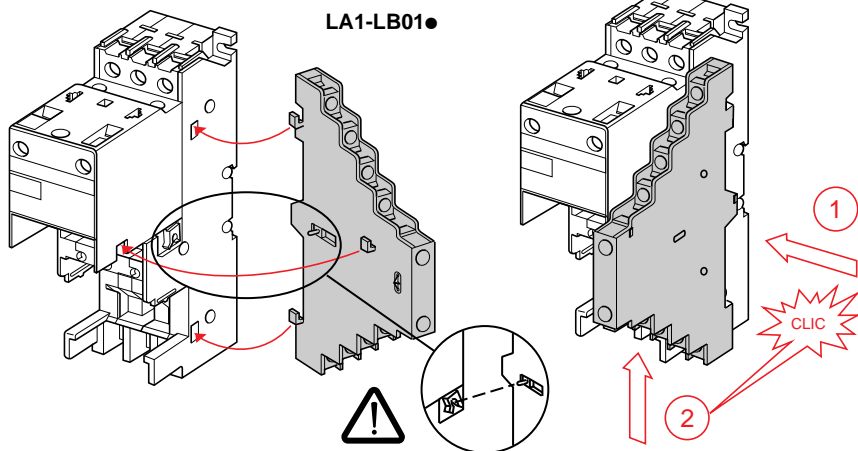

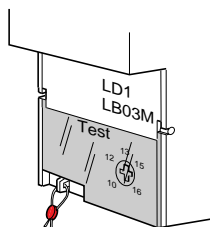
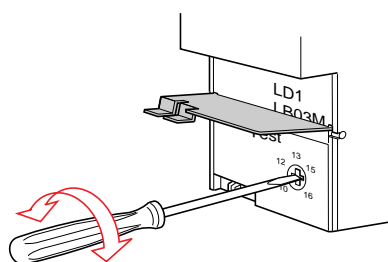
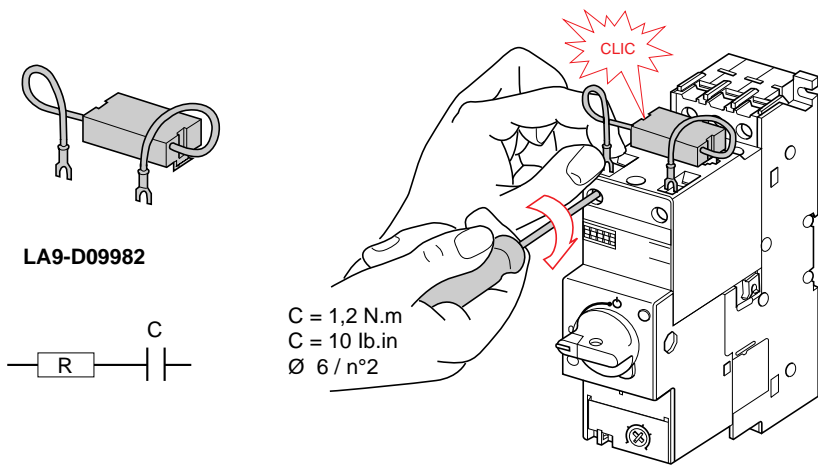
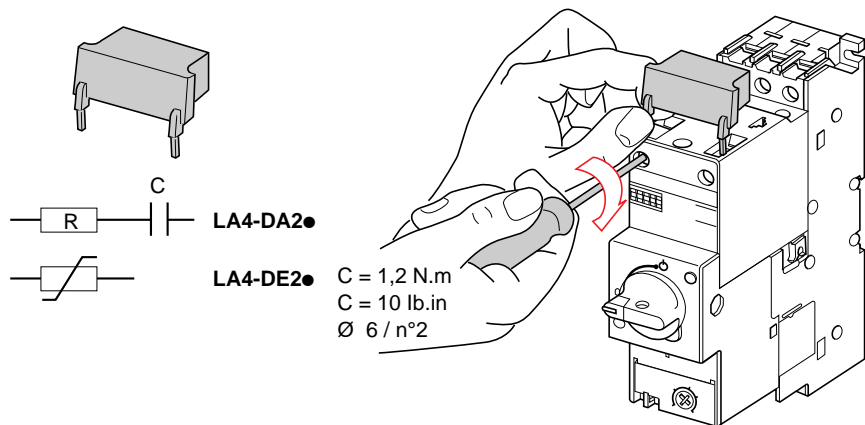

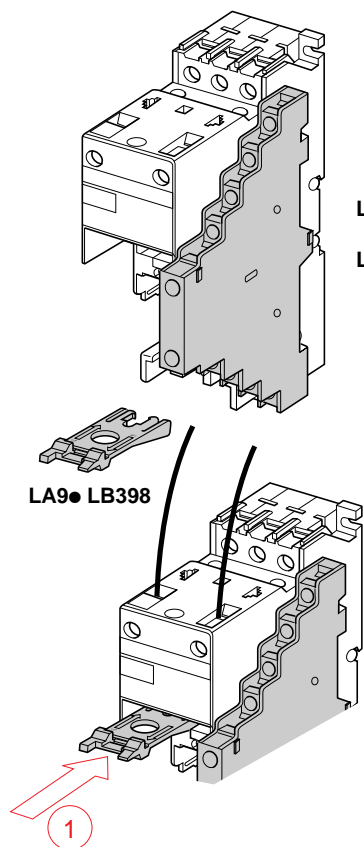

LD1●LB03●
+
LA1●LB01●

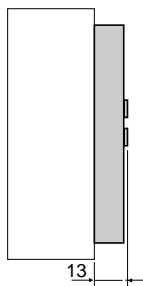
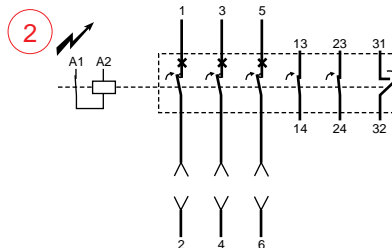
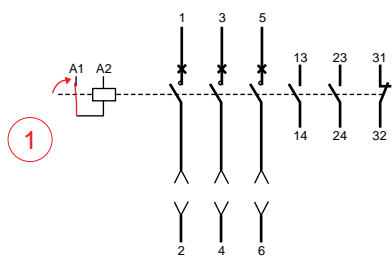
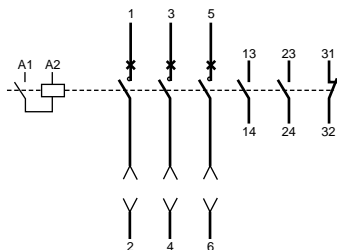

LA1-LB015
LA1-LB017
LA1-LB019

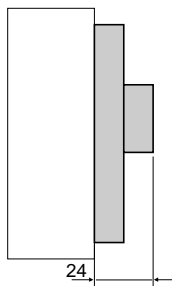

LA1-LB01●
+
LA1-LB001

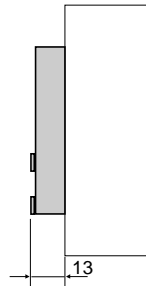

LA1-LB03●