



Main

Commercial Status	Commercialised
Range of product	Harmony XB5
Product or component type	Head for non-illuminated pushbutton
Device short name	ZB5
Bezel material	Plastic
Mounting diameter	22 mm
Sale per indivisible quantity	1
Shape of signaling unit head	Round
Type of operator	Spring return
Operator profile	Red flush unmarked
Operator additional information	Coloured boot
Additional information	Compatible with legend holder

Complementary

CAD overall width	30 mm
CAD overall height	30 mm
CAD overall depth	33 mm
Product weight	0.021 kg
Mechanical durability	5000000 cycles
Maximum of contact NO or NC	9
Station name	XALK 2...5 cut-outs XALD 1...5 cut-outs

Environment

Protective treatment	TH
Ambient air temperature for storage	-40...70 °C
Ambient air temperature for operation	-25...70 °C
Class of protection against electric shock	Class II conforming to IEC 60536
IP degree of protection	IP66 conforming to IEC 60529
NEMA degree of protection	NEMA 4X NEMA 13
Resistance to high pressure washer	7000000 Pa at 55 °C, distance: 0.1 m
IK degree of protection	IK03 conforming to IEC 50102
Standards	CSA C22-2 No 14 EN/IEC 60947-1 EN/IEC 60947-5-1 EN/IEC 60947-5-4 EN/IEC 60947-5-5 JIS C 4520 UL 508
Product certifications	BV CSA DNV GL LROS (Lloyds register of shipping) RINA UL listed

The information provided in this documentation contains general descriptions and/or technical characteristics of the performance of the products contained herein. This documentation is not intended as a substitute for and is not to be used for determining suitability or reliability of these products for specific user applications. It is the duty of any such user or integrator to perform the appropriate and complete risk analysis, evaluation and testing of the products with respect to the relevant specific application or use thereof. Neither Schneider Electric Industries SAS nor any of its affiliates or subsidiaries shall be responsible or liable for misuse of the information contained herein.

Vibration resistance	5 gn (f = 2...500 Hz) conforming to IEC 60068-2-6
Shock resistance	50 gn for 11 ms half sine wave acceleration conforming to IEC 60068-2-27 30 gn for 18 ms half sine wave acceleration conforming to IEC 60068-2-27

Dimensions of Heads for Spring Return Pushbuttons

Heads for Spring Return Pushbuttons

ZB5 AA•, ZB5 AA•••, ZB5 AA•8

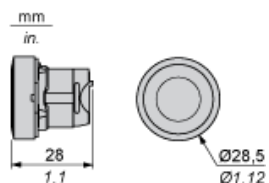

ZB5 AL•, ZB5 AL•••

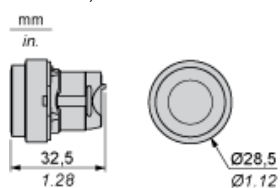

ZB5 AA•4, ZB5 AA•6

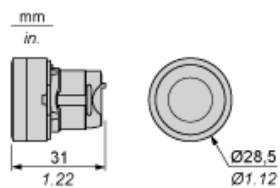

ZB5 AP••, ZB5 AP•S, ZB5 AP•83, ZB5 AP•

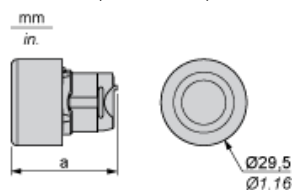

	a in mm	a in in.
ZB5 AP••	36.5	1.44
ZB5 AP•S	33	1.30
ZB5 AP•83	32	1.26
ZB5 AP•	35	1.38

ZB5 CA•, ZB5 CA0

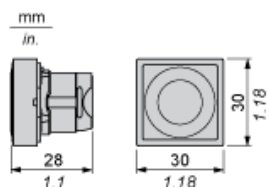

ZB5 CL•

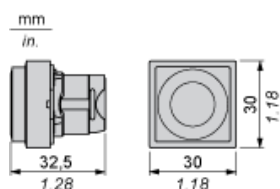

Mushroom Heads for Spring Return Pushbuttons

ZB5 AC•4

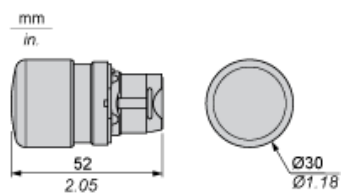

ZB5 AC•, ZB5 AR•

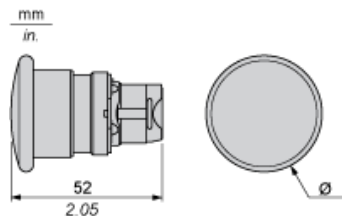

	Ø in mm	Ø in in.
ZB5 AC•	40	1.57
ZB5 AR•	60	2.36

ZB5 AR•16

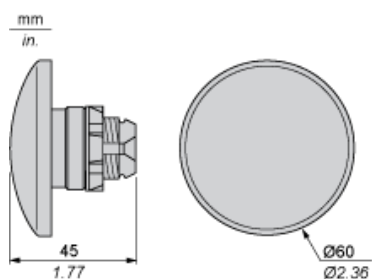

Heads for Double-Headed, Spring Return Pushbuttons

ZB5 AA712•, ZB5 AA734•, ZB5 AA79

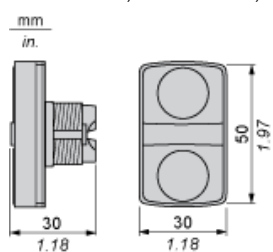

ZB5 AL734•

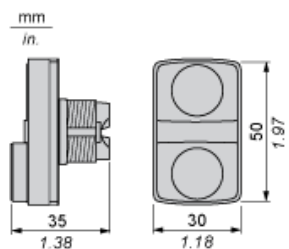

ZB5 AA712•, ZB5 AA734•, ZB5 AA79 + boot ZBA 708

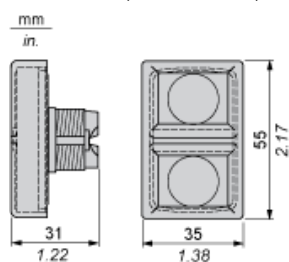

ZB5 AL734• + boot ZBA 710

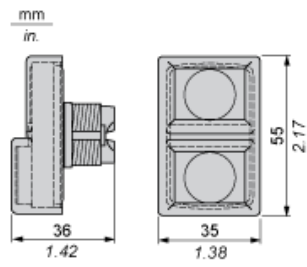

Heads for Triple-Headed, Spring Return Pushbuttons

ZB5 AA7313•, ZB5 AA711••, ZB5 AA72124, ZB5 AA791

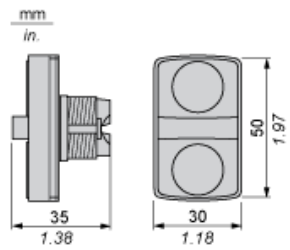

ZB5 AA7313•, ZB5 AA711••, ZB5 AA72124, ZB5 AA791 + boot ZBA 709

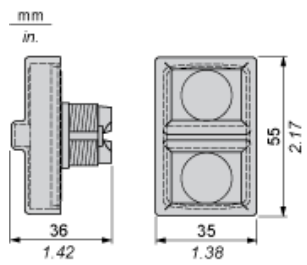

Heads for Lockable, Push-Turn Pushbuttons

ZB5 AFD

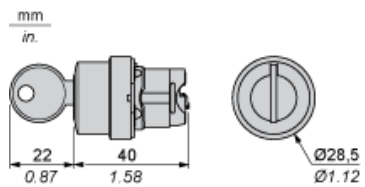

Panel Cut-out for Pushbuttons, Switches and Pilot Lights (Finished Holes, Ready for Installation)

Connection by Screw Clamp Terminals or Plug-in Connectors or on Printed Circuit Board

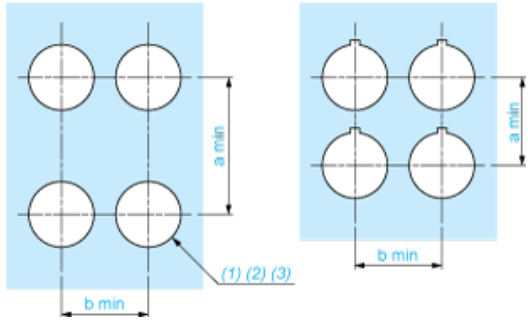

- (1) Diameter on finished panel or support
- (2) For selector switches and Emergency stop buttons, use of an anti-rotation plate type ZB5 AZ902 is recommended.
- (3) $\varnothing 22.5$ mm recommended ($\varnothing 22.3 \text{ }_0^{+0.4}$) / $\varnothing 0.89$ in. recommended ($\varnothing 0.88 \text{ in. }_0^{+0.016}$)

Connections	a in mm	a in in.	b in mm	b in in.
By screw clamp terminals or plug-in connector	40	1.57	30	1.18
By Faston connectors	45	1.77	32	1.26
On printed circuit board	30	1.18	30	1.18

Detail of Lug Recess

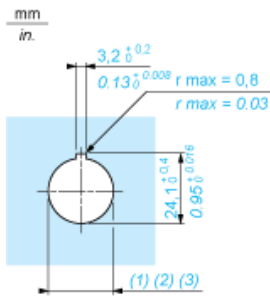

- (1) Diameter on finished panel or support
- (2) For selector switches and Emergency stop buttons, use of an anti-rotation plate type ZB5 AZ902 is recommended.
- (3) $\varnothing 22.5$ mm recommended ($\varnothing 22.3 \text{ }_0^{+0.4}$) / $\varnothing 0.89$ in. recommended ($\varnothing 0.88 \text{ in. }_0^{+0.016}$)

Pushbuttons, Switches and Pilot Lights for Printed Circuit Board Connection

Panel Cut-outs (Viewed from Installer's Side)

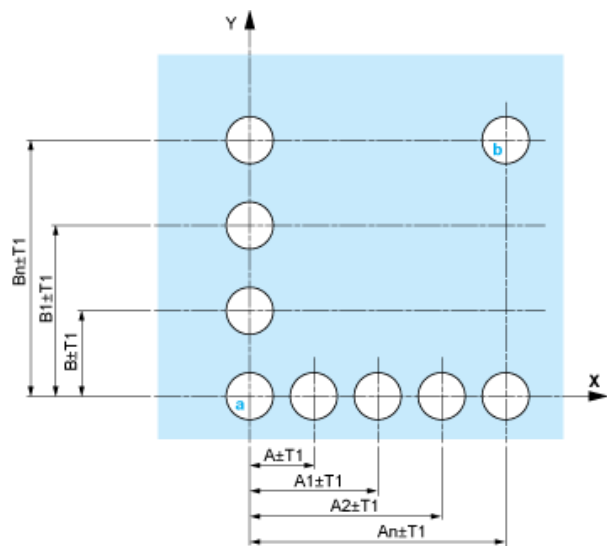

- A: 30 mm min. / 1.18 in. min.
- B: 40 mm min. / 1.57 in. min.

Printed Circuit Board Cut-outs (Viewed from Electrical Block Side)

Dimensions in mm

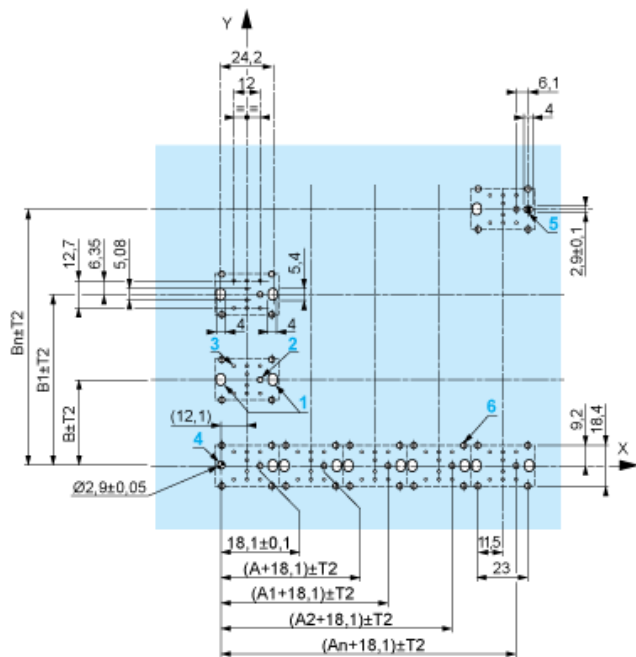

- A: 30 mm min.
- B: 40 mm min.

Dimensions in in.

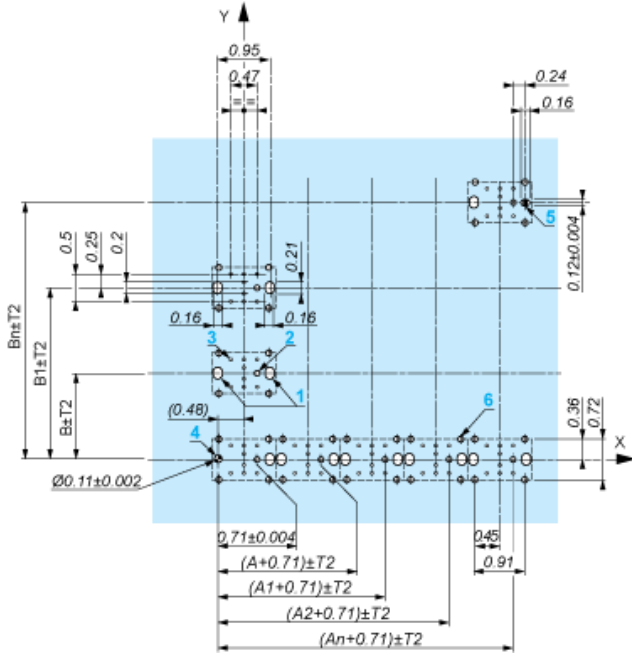

A: 1.18 in. min.
 B: 1.57 in. min.

General Tolerances of the Panel and Printed Circuit Board

The cumulative tolerance must not exceed 0.3 mm / 0.012 in.: T1 + T2 = 0.3 mm max.

Installation Precautions

- Minimum thickness of circuit board: 1.6 mm / 0.06 in.
- Cut-out diameter: 22.4 mm ± 0.1 / 0.88 in. ± 0.004
- Orientation of body/fixing collar ZB4 BZ009: ± 2°30' (excluding cut-outs marked a and b).
- Tightening torque of screws ZBZ 006: 0.6 N.m (5.3 lbf.in) max.
- Allow for one ZB4 BZ079 fixing collar/pillar and its fixing screws:
 - every 90 mm / 3.54 in. horizontally (X), and 120 mm / 4.72 in. vertically (Y).
 - with each selector switch head (ZB5 AD•, ZB5 AJ•, ZB5 AG•).

The fixing centers marked a and b are diagonally opposed and must align with those marked 4 and 5.

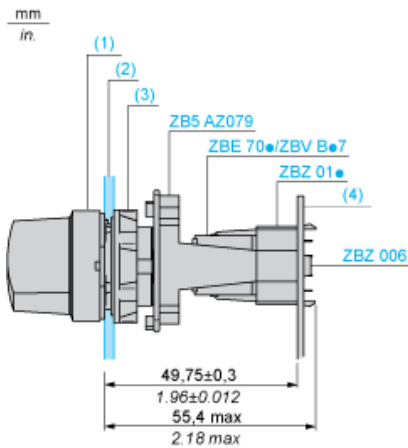

- (1) Head ZB5 AD•
- (2) Panel
- (2) Nut
- (4) Printed circuit board

Mounting of Adapter (Socket) ZBZ 01•

- 12 elongated holes for ZBZ 006 screw access
- 2 1 hole Ø 2.4 mm ± 0.05 / 0.09 in. ± 0.002 for centring adapter ZBZ 01•
- 3 8 × Ø 1.2 mm / 0.05 in. holes
- 4 1 hole Ø 2.9 mm ± 0.05 / 0.11 in. ± 0.002, for aligning the printed circuit board (with cut-out marked a)
- 5 1 elongated hole for aligning the printed circuit board (with cut-out marked b)
- 6 4 holes Ø 2.4 mm / 0.09 in. for clipping in adapter ZBZ 01•

Dimensions An + 18.1 relate to the $\varnothing 2.4 \text{ mm} \pm 0.05 / 0.09 \text{ in.} \pm 0.002$ holes for centring adapter ZBZ 01•.