

XS4P18MA230

inductive sensor XS4 M18 - L62mm - PPS - Sn8mm - 24..240VAC/DC - cable 2m



Main

Range of product	OsiSense XS
Series name	General purpose
Sensor type	Inductive proximity sensor
Device application	-
Sensor name	XS4
Sensor design	Cylindrical M18
Size	62 mm
Body type	Fixed
Detector flush mounting acceptance	Non flush mountable
Material	Plastic
Type of output signal	Discrete
Wiring technique	2-wire
[Sn] nominal sensing distance	8 mm
Discrete output function	1 NO
Output circuit type	AC/DC
Electrical connection	Cable
Cable length	2 m
[Us] rated supply voltage	24...240 V AC/DC, 50/60 Hz
Switching capacity in mA	5...200 mA DC 5...300 mA AC
IP degree of protection	IP68 double insulation conforming to IEC 60529

Complementary

Thread type	M18 x 1
Detection face	Frontal
Front material	PPS
Enclosure material	PPS
Operating zone	0...6.4 mm
Differential travel	1...15% of Sr
Cable composition	2 x 0.34 mm ²
Wire insulation material	PvR
Status LED	1 LED (yellow) for output state
Supply voltage limits	20...264 V AC/DC
Residual current	<= 0.6 mA (open state)
Switching frequency	<= 2000 Hz (DC) <= 25 Hz (AC)
Voltage drop	<= 5.5 V (closed)
Delay first up	<= 40 ms
Delay response	<= 0.2 ms
Delay recovery	<= 0.2 ms
Marking	CE
Threaded length	52 mm
Height	18 mm
Length	62 mm
Product weight	0.1 kg

The information provided in this documentation contains general descriptions and/or technical characteristics of the products contained herein. This documentation is not intended as a substitute for and is not to be used for determining suitability or reliability of these products for specific user applications. It is the duty of any such user or integrator to perform the appropriate and complete risk analysis, evaluation and testing of the products with respect to the relevant specific application or use thereof. Neither Schneider Electric Industries SAS nor any of its affiliates or subsidiaries shall be responsible or liable for misuse of the information contained herein.

Environment

product certifications	CCC CSA UL Ecolab
ambient air temperature for operation	-25...70 °C
ambient air temperature for storage	-40...85 °C
vibration resistance	25 gn, amplitude: +/- 2 mm (f = 10...55 Hz) conforming to IEC 60068-2-6
shock resistance	50 gn (duration = 11 ms) conforming to IEC 60068-2-27

Offer Sustainability

Sustainable offer status	Green Premium product
RoHS (date code: YYWW)	Compliant - since 0810 - Schneider Electric declaration of conformity
REACH	Reference not containing SVHC above the threshold
Product environmental profile	Available
Product end of life instructions	Available

Dimensions

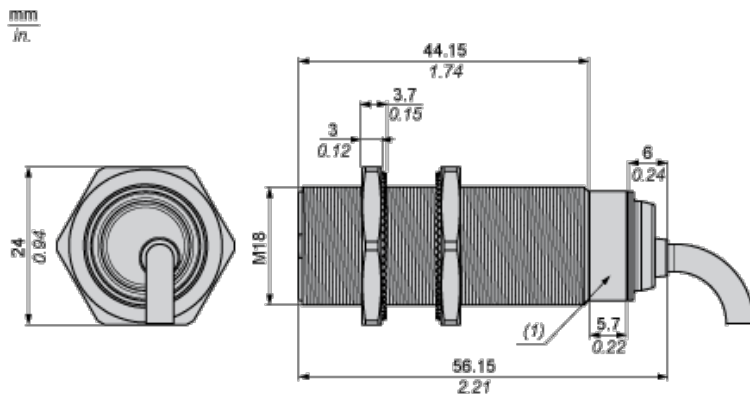

(1) LED

Minimum Mounting Distances

Side by side

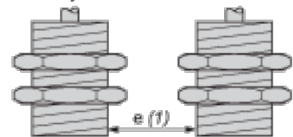

e (1) 32 mm/1.26 in.

≧

Face to face

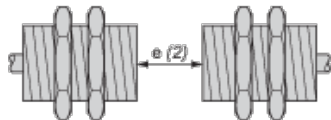

e (2) 96 mm/3.78 in.

≧

Facing a metal object

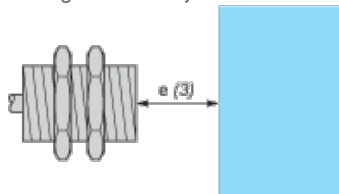

e (3) 24 mm/0.94 in.

≥

Mounted in a metal support

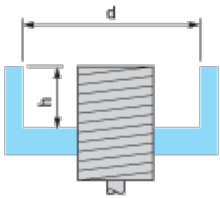

d ≥ 56 mm/2.20 in.

h ≥ 16 mm/0.63 in.

Mounting

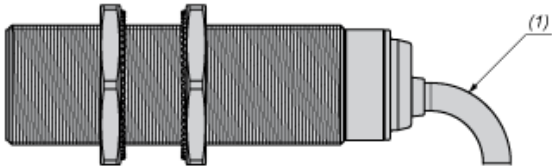

(1) Bending cable: 4 x external cable diameter

Wiring Schemes

2-Wire AC or DC

NO output

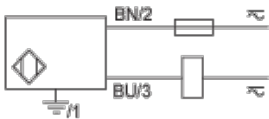

BU : Blue

BN : Brown

Performance Curves

Standard Steel Target : 24x24x1 mm

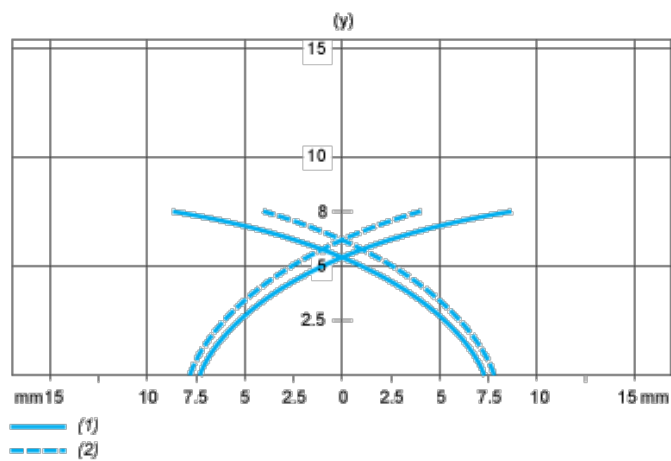

(1) Pick-up points

(2) Drop-out points (object approaching from the side)

(y) Sensing distance in mm