

XS1M18PAS40

inductive sensor XS1 M18 - L60mm - stainless -
Sn5mm - 12..24VDC - cable 2m



Main

Range of product	OsiSense XS
Series name	Application
Sensor type	Inductive proximity sensor
Device application	Selective detection of ferrous materials
Sensor name	XS1
Sensor design	Cylindrical M18
Size	60 mm
Body type	Fixed
Detector flush mounting acceptance	Flush mountable
Material	Stainless steel
Type of output signal	Discrete
Wiring technique	3-wire
[Sn] nominal sensing distance	5 mm
Discrete output function	1 NO
Output circuit type	DC
Discrete output type	PNP
Electrical connection	Cable
Cable length	2 m
[Us] rated supply voltage	12...24 V DC with reverse polarity protection
Switching capacity in mA	<= 200 mA with overload and short-circuit protection
IP degree of protection	IP68 conforming to IEC 60529

Complementary

Thread type	M18 x 1
Detection face	Frontal
Front material	PPS
Enclosure material	Stainless steel : 304 CU
Operating zone	0...4 mm
Cable composition	3 x 0.34 mm ²
Wire insulation material	PvR
Status LED	1 LED yellow for output state
Supply voltage limits	10...38 V DC
Switching frequency	<= 1000 Hz
Voltage drop	<= 2.6 V at closed state
Current consumption	0...15 mA at no-load
Delay first up	<= 10 ms
Delay response	<= 0.3 ms
Delay recovery	<= 0.7 ms
Marking	CE
Threaded length	52 mm
Length	60 mm
Product weight	0.12 kg

The information provided in this documentation contains general descriptions and/or technical characteristics of the products contained herein. This documentation is not intended as a substitute for and is not to be used for determining suitability or reliability of these products for specific user applications. It is the duty of any such user or integrator to perform the appropriate and complete risk analysis, evaluation and testing of the products with respect to the relevant specific application or use thereof. Neither Schneider Electric Industries SAS nor any of its affiliates or subsidiaries shall be responsible or liable for misuse of the information contained herein.

Environment

product certifications	CSA UL
ambient air temperature for operation	-25...70 °C

Offer Sustainability

Sustainable offer status	Green Premium product
RoHS (date code: YYWW)	Compliant - since 1104 - Schneider Electric declaration of conformity
REACH	Reference not containing SVHC above the threshold
Product environmental profile	Available
Product end of life instructions	Available

Dimensions

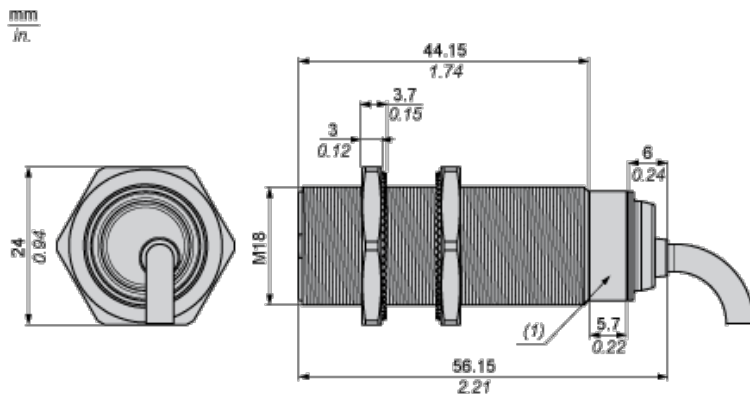

(1) LED

Minimum Mounting Distances

Side by side

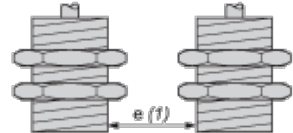

e (1) 10 mm/0.39 in.

≧

Face to face

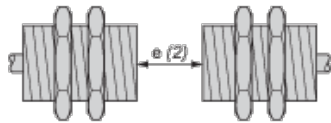

e (2) 60 mm/2.36 in.

≧

Facing a metal object

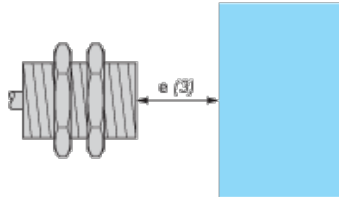

e (3) 15 mm/0.60 in

≧

Mounting

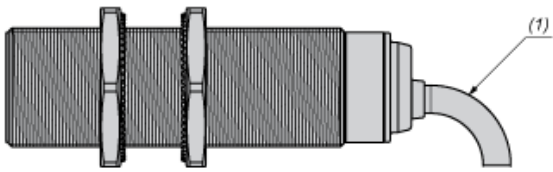

(1) Bending cable: 4 x external cable diameter

Wiring Schemes

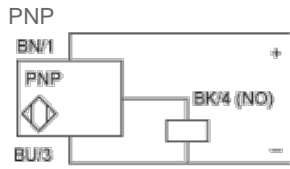

BU : Blue
 BN : Brown
 BK : Black

Performance Curves

Standard Steel Target : 18x18x1 mm

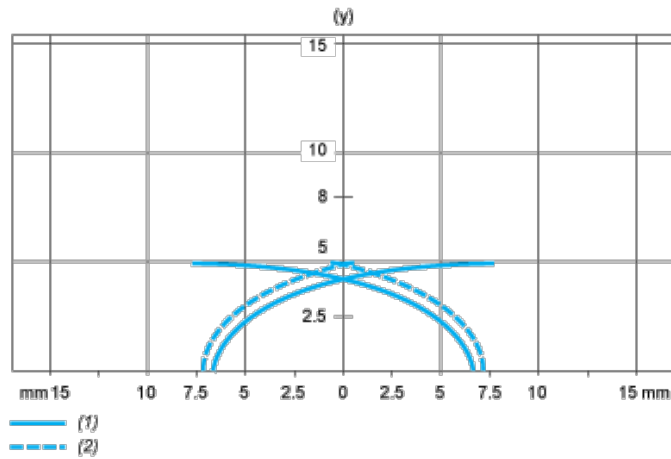

(1) Pick-up points
 (2) Drop-out points (object approaching from the side)
 (y) Sensing distance in mm