

XAPA2100

empty control station - XAP-A - plastic - without opening

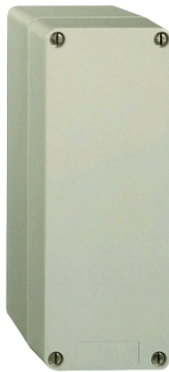

Main

Range of product	Harmony XAP
Product or component type	Empty control station without hinges
Device short name	XAPA
Product front plate size	85 x 226 mm
Usable depth	83 mm
Number of cut-out	Undrilled
Colour of base of enclosure	Grey
Colour of cover	Grey
Material	Glass reinforced polyester
Cable entry	Undrilled
Device mounting	Flush
IP degree of protection	IP65 conforming to IEC 60529 IP69K IP69 conforming to NF C 20-010
Resistance to chemical agents	High resistant to acids High resistant to all solvents High resistant to bases High resistant to diesel High resistant to mineral salts High resistant to oils and greases High resistant to petrol High resistant to sea water

Complementary

Product weight	0.6 kg
Flame retardance	M3 conforming to CSTB VO conforming to UL 94

Environment

protective treatment	TC TH
ambient air temperature for storage	-40...70 °C
ambient air temperature for operation	-40...70 °C
overvoltage category	Class II conforming to IEC 60536 Class II conforming to NF C 20-030
fire resistance	850 °C conforming to NF C 20-455 960 °C conforming to IEC 92

Dimensions and Fixing

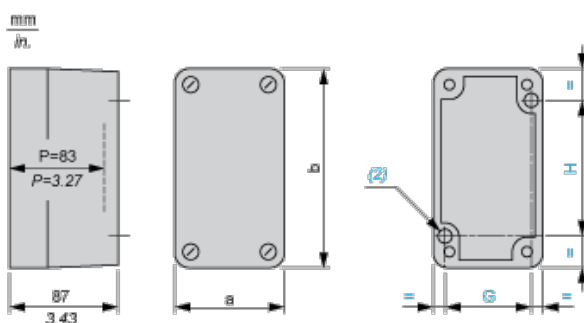

(2) 2 x Ø 5.6 mm/4.94 in. holes, depth 12 mm/0.47 in.

P Usable depth

a		b		G		H	
mm	in.	mm	in.	mm	in.	mm	in.
85	3.35	226	8.90	70	2.76	180	7.09