

9001KYSS2

empty control station - 9001K - stainless steel - 2
cut-outs Ø 30



Main

Range of product	Harmony 9001K Harmony 9001SK
Product or component type	Empty enclosure
Device short name	9001K
Number of cut-out	2 cut-outs
Cable entry	1 entry tapped for 3/4" knockout

Complementary

Product destination	For Ø 30 mm control and signalling units
Material	Stainless steel
Product weight	1.37 kg

Environment

protective treatment	TH
ambient air temperature for storage	-40...70 °C
ambient air temperature for operation	-25...70 °C
overvoltage category	II conforming to IEC 61140
NEMA degree of protection	NEMA 1 NEMA 12 NEMA 3 NEMA 4 NEMA 4X

Offer Sustainability

Sustainable offer status	Green Premium product
RoHS (date code: YYWW)	Compliant - since 1230 - Schneider Electric declaration of conformity
REACH	Reference not containing SVHC above the threshold
Product environmental profile	Available
Product end of life instructions	Need no specific recycling operations

Dimensions

Below drawing shows a 3-hole enclosure. Refer to the product characteristics to get the number of holes

The information provided in this documentation contains general descriptions and/or technical characteristics of the performance of the products contained herein. This documentation is not intended as a substitute for and is not to be used for determining suitability or reliability of these products for specific user applications. It is the duty of any such user or integrator to perform the appropriate and complete risk analysis, evaluation and testing of the products with respect to the relevant specific application or use thereof. Neither Schneider Electric Industries SAS nor any of its affiliates or subsidiaries shall be responsible or liable for misuse of the information contained herein.

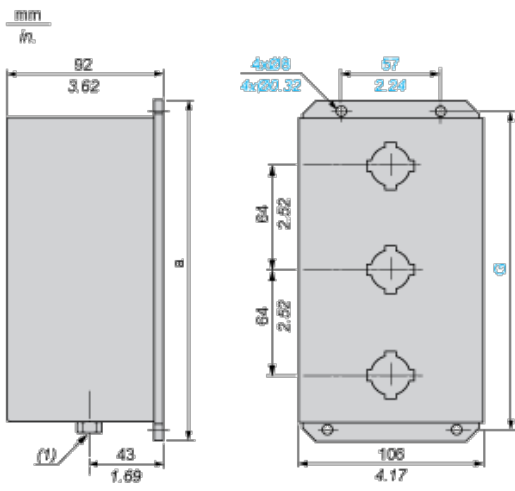

(1) Knockout conduit thread: 3/4".

a		G	
mm	in.	mm	in.
197	7.75	181	7.12