



Main

Range of product	Harmony 9001K Harmony 9001SK
Product or component type	Empty enclosure
Device short name	9001K
Number of cut-out	4 cut-outs
Cable entry	1 entry tapped for 3/4" cable gland

Complementary

Product destination	For Ø 30 mm control and signalling units
Material	Aluminium
Product weight	1.84 kg

Environment

protective treatment	TH
ambient air temperature for storage	-40...70 °C
ambient air temperature for operation	-25...70 °C
overvoltage category	II conforming to IEC 61140
NEMA degree of protection	NEMA 1 NEMA 12 NEMA 13 NEMA 3 NEMA 4 NEMA 6

Offer Sustainability

Sustainable offer status	Green Premium product
RoHS (date code: YYWW)	Compliant - since 1230 - Schneider Electric declaration of conformity
REACH	Reference not containing SVHC above the threshold
Product environmental profile	Available
Product end of life instructions	Need no specific recycling operations

Dimensions

Below drawing shows a 2-hole enclosure. Refer to the product characteristics to get the number of holes.

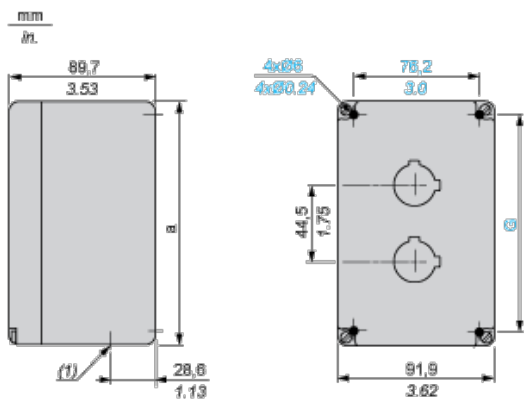

(1) Conduit thread: 9001 KY•: 3/4". 9001 TY• : 14 mm / 0.55 in.

a		G	
mm	in.	mm	in.
235.0	9.25	203.2	8.00