

Catalogue No: **NTIS 63**

FUSE gG SIZE A3 73mm CENTRES 500V AC 63A

Power Distribution and Protection > Fuse Isolators and Fuse Gear > Fuses and Fuse Holders > NHP Fuses and Fuse Holders > BS Fuse Links > Bolted Type Offset Tag



Fuse gG Size A3 73mm Centres 500V AC 63A

- Complies to BS Standard.
- 80 kA fault interruption capacity.
- Type gG and gM general, cable and motor protection.
- 2 to 200A range.
- 415/500V AC rated.

Representative Photo Only
(actual product may vary based on configuration selections)

SPECIFICATIONS

Product Series	NTIS
Component Type Fuse-gear	Fuse Link
Fuse Current Rating	63 A
Fuse Characteristic Type(s)	gG
Fuse Cartridge Size	A3 size
Un, Nominal Operational Voltage, AC	500 V AC
Ue, Rated Operational Voltage, AC, max	500 V AC
Current, Breaking Capacity at Un	80 kA @Un
Height	88.5 mm
Width	17.5 mm
Depth	17.5 mm
Standards Compliance	AS 60269-1:2005 BS 88 DIN 43620 IEC 60269-1 IEC 60269-2 VDE 0636-10
Certifications	ASTA



Catalogue No: **NTIS 63**

FUSE gG SIZE A3 73mm CENTRES 500V AC 63A

Power Distribution and Protection > Fuse Isolators and Fuse Gear > Fuses and Fuse Holders > NHP Fuses and Fuse Holders > BS Fuse Links > Bolted Type Offset Tag



REFERENCES	
IECEX Certificate	-
Supplier Declaration of Conformity:	-
Installation Guide:	-
User Manual:	-
Manufacturer Datasheet:	-
Manufacturer Catalogue & Product Selection:	-

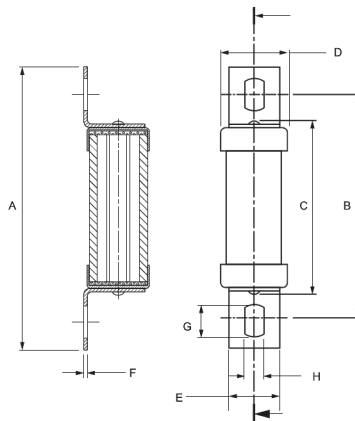

Series	Category	Brand	A Overall Length	B Fitting Centres	C Body Length	D Body Diameter	E Tag Width	F Tag Thickness	G Hole Length	H Hole Width
NTIA 2 – 32	A2	Mersen	84.5	73	55	13.5	8.7	1.2	8	5.5
NTIA 32M	A2	Mersen	86	73	49	21.9	9	1.2	8	5.5
NTIS 36 – 63	A3	Mersen	88.5	73	56	17.5	-	1.2	-	5.5
NTIS 80 – 100	A3	Mersen	89	73	49	26.9	13	1.2	-	5.5
NTIS 63M	A3	Mersen	89	73	49	26	13	1.2	-	5.5
NTIS 100M	A3	Mersen	89	73	49	26	13	1.2	-	5.5
NOS 80 - 100	as A3	FuseMaster	89	73	49	26	13	1.2	-	5.5
NOS 100M	as A3	Lawson	89	73	49	TBC	13	1.2	-	5.5

Dimension Diagram