

Catalogue No: **D7P-MT34PX01**

PUSHBUTTON 22.5mm PLASTIC E-STOP 30mm 1NC

Operator Control Devices > Pushbuttons and Control Switches > Pushbuttons and Pilot Lights > Sprecher + Schuh D7 Pushbuttons and Pilot Lights > D7 Emergency Stop Operators > D7 Complete Emergency Stop Operators



Button emergency stop plastic 30mm 1N/C

- D7 pilot devices offer maximum flexibility and a wide choice for all 22.5mm operator applications with all type (e-stops, selector switches, pushbuttons, pilot lights and more), colour and contact configurations.
- Aesthetically appealing and modularly designed to make assembly and interchangeability easy.
- Operators exhibit low profile and stylish appearance while maintaining the rugged performance necessary for demanding environments
- D7P is a plastic operator with a captive black plastic front bezel. Constructed of high-grade thermoplastics, the D7P is suitable for almost all environments and strong chemical resistance.
- D7M has a die-cast zinc housing and mounting ring for rugged durability. Finished with corrosion resistant chrome plating, the D7M also features a captive shiny metal bezel for a polished appearance.

Representative Photo Only
(actual product may vary based on configuration selections)

SPECIFICATIONS

Component Type Pushbutton and Pilot Lights	E-Stop
Operator Type	E-Stop, Mushroom Head type
Operator Action	Twist to Release action
Key	No Y / N
Diameter, Operator	30 mm
Colour, Operator	Red colour
Material, Operator	Plastic material
Material, Bezel	Glass-Filled Nylon / PA6 / PA66 (Polyamide 6)
Coupling Plate Included	Yes Y / N
Material, Coupling Plate	Glass-Filled Nylon / PA6 / PA66 (Polyamide 6)
Tightening Torque, Nominal	1.7 Nm
Material, Gasket / Seal	TP (Thermoplastic) material
Material, Body / Housing	Polycarbonate & PBT Blend material
Mounting	22.5mm Mounting
Padlockable	Yes
Contact Block Included	Yes
Contact Configuration	1 NC
In, Rated Current	10 A
Ie, Rated Operational Current, AC-1, 240V	10 A@240V
Ie, Rated Operational Current, AC-15, 110-120V	6 A@110-120V
Ie, Rated Operational Current, AC-15, 240V	3 A@240V
Ie, Rated Operational Current, AC-15, 415V	2.2 A@415V
Ie, Rated Operational Current, DC-13, 125V	0.6 A@125V
Ui, Rated Insulation Voltage	680 V (rms)
Compatible Product Series	D7 22.5mm Control & Indication compatible
Material, Contacts	Silver Nickel (AgNi) material
Colour, Contact Actuator	Red
Terminal Type	Screw Terminal(s)

Catalogue No: **D7P-MT34PX01**

PUSHBUTTON 22.5mm PLASTIC E-STOP 30mm 1NC

Operator Control Devices > Pushbuttons and Control Switches > Pushbuttons and Pilot Lights > Sprecher + Schuh D7 Pushbuttons and Pilot Lights > D7 Emergency Stop Operators > D7 Complete Emergency Stop Operators



Material, Terminal	Brass
Material, Spring	Stainless Steel
Operating Force	36 N
Linear Travel to Actuation	1.5 mm
Pickup Voltage	17 V
Pickup Current	5 mA
Ith, Thermal Current, Open	10 A
Wire / Conductor Size (Min)	0.75 mm ² min
Wire / Conductor Size (Max)	2.5 mm ²
Dielectric Strength	2.5kV for 1 minute
Recommended Fuse Current Rating	10 A
Fuse Characteristic Type(s)	gL/gG
Illuminated	No Y / N
Electrical Service Life at Un, In	500000 cycles
Mechanical Service Life	300000 cycles
RoHS Approved	Yes
CE Marked	Yes
Operating Temperature, Max	70 °C max
Operating Temperature, Min	-25 °C min
Storage Temperature, Max	85 °C max
Storage Temperature, Min	-25 °C min
Relative humidity, min	50 %RH
Relative Humidity, Max	95 %RH
IP Rating	IP66 IP65
Shock Acceleration (Max.)	100 g
Shock Duration (Max.)	11 ms
Vibration Acceleration (Max.)	10 m/s ²
Vibration Displacement (Peak to Peak Max.)	1.52 mm
Vibration Frequency, Operational (Max.)	2000 Hz
Vibration Duration (Max.)	180 min
Standards Compliance	NEMA ICS-5 UL 508 EN 60947-1 EN 60947-5-1 EN 60947-5-5 EN 418
Certifications	UL UR CSA CCC CE
Shipping Approvals	RINA (Registro Italiano Navale) ABS (American Bureau of Shipping) Lloyd's Register of Shipping

Catalogue No: **D7P-MT34PX01**

PUSHBUTTON 22.5mm PLASTIC E-STOP 30mm 1NC

Operator Control Devices > Pushbuttons and Control Switches > Pushbuttons and Pilot Lights > Sprecher + Schuh D7
Pushbuttons and Pilot Lights > D7 Emergency Stop Operators > D7 Complete Emergency Stop Operators



REFERENCES

IECEX Certificate -

Supplier Declaration of
Conformity: -

Installation Guide: -

User Manual: -

Manufacturer Datasheet: [Series D7_Manufacturer Datasheet](#)

Manufacturer Catalogue
& Product Selection: -

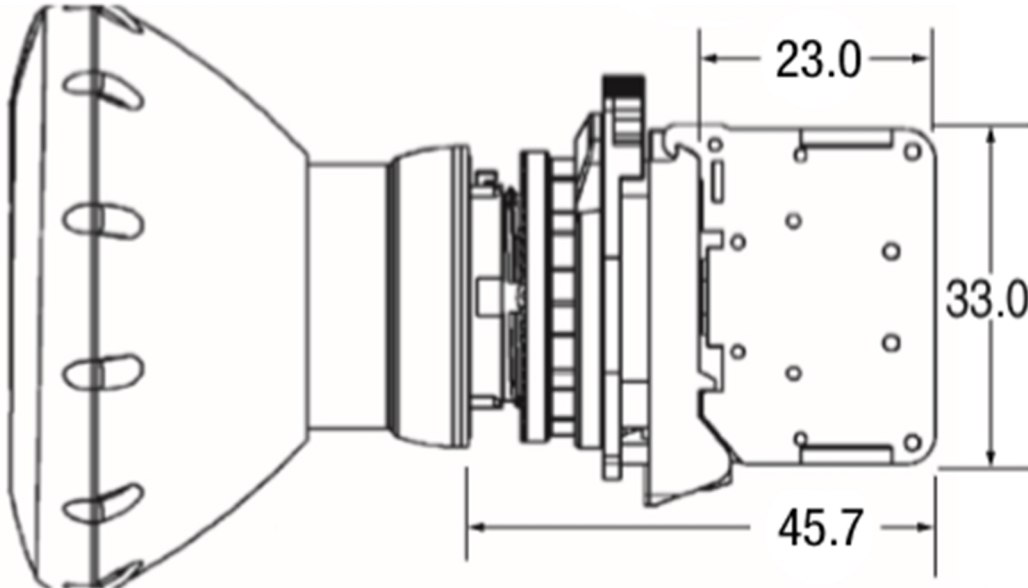

Dimension Diagram