

Catalogue No: **D7M-JM4**

TOGGLE SWITCH 22.5mm METAL 4 POSITION MAINTAINED

Operator Control Devices > Pushbuttons and Control Switches > Pushbuttons and Pilot Lights > Sprecher + Schuh D7 Pushbuttons and Pilot Lights > D7 Toggle Switches > Metal Body - Stayput



Joystick metal operator 4 position maintained



- The D7 range of 22.5mm operator control devices includes a diverse range of products making it suitable for use in a wide range of applications. Products in the range include pushbuttons, selector switches, pilot lights, emergency stop operators and more.
- Aesthetically appealing and modularly designed to make assembly and interchangeability easy.
- Operators exhibit low profile and stylish appearance while maintaining the rugged performance necessary for demanding environments
- Operators are available in both plastic (D7P) and metal (D7M) variants.

Representative Photo Only
(actual product may vary based on configuration selections)

SPECIFICATIONS

Product Series	D7M-JM
Component Type Pushbutton and Pilot Lights	Toggle Switch
Number of Positions	4
Operator Action	Latched / Maintained action
Material, Bezel	Zinc
Electrical Service Life at Un, In	500000 cycles
Mechanical Service Life	10000000 cycles
RoHS Approved	Yes
CE Marked	Yes
Operating Temperature, Max	70 °C max
Operating Temperature, Min	-25 °C min
Storage Temperature, Max	85 °C max
Storage Temperature, Min	-25 °C min
Relative Humidity, Min	50 %RH
Relative Humidity, Max	95 %RH
IP Rating	IP65 IP66
Shock Acceleration (Max.)	100 g
Shock Duration (Max.)	11 ms
Vibration Acceleration (Max.)	10 m/s ²
Vibration Displacement (Peak to Peak Max.)	1.52 mm
Vibration Frequency, Operational (Max.)	2000 Hz
Vibration Duration (Max.)	180 min
Standards Compliance	NEMA ICS-5 UL 508 EN 60947-1 EN 60947-5-1 EN 60947-5-5 EN 418

Catalogue No: **D7M-JM4**

TOGGLE SWITCH 22.5mm METAL 4 POSITION MAINTAINED

Operator Control Devices > Pushbuttons and Control Switches > Pushbuttons and Pilot Lights > Sprecher + Schuh D7
Pushbuttons and Pilot Lights > D7 Toggle Switches > Metal Body - Stayput



Certifications	UL UR CSA CCC CE
Shipping Approvals	RINA (Registro Italiano Navale) ABS (American Bureau of Shipping) Lloyd's Register of Shipping

REFERENCES	
IECEX Certificate	-
Supplier Declaration of Conformity:	-
Installation Guide:	-
User Manual:	-
Manufacturer Datasheet:	Series D7 Manufacturer Datasheet
Manufacturer Catalogue & Product Selection:	-

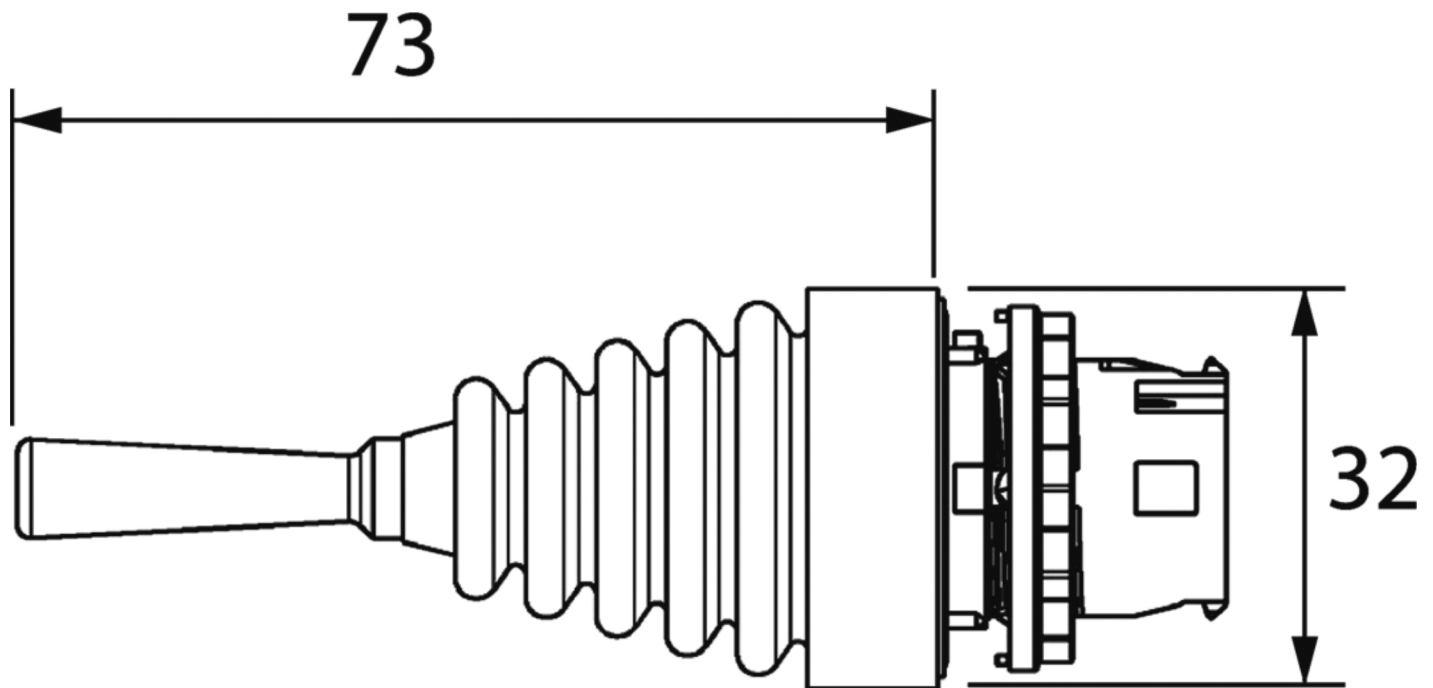







Dimension Diagram

Catalogue No: **D7M-JM4**

TOGGLE SWITCH 22.5mm METAL 4 POSITION MAINTAINED

Operator Control Devices > Pushbuttons and Control Switches > Pushbuttons and Pilot Lights > Sprecher + Schuh D7
 Pushbuttons and Pilot Lights > D7 Toggle Switches > Metal Body - Stayput



Target Table and Operator Positions (4 Position) 						
Contact Type	Position on Mounting Latch					
		Toggle Up	Toggle Left	Center	Toggle Right	Toggle Down
N.O.	Left	X	0	0	0	0
N.O.	Right	0	X	0	0	0
N.O.	Center	X	X	0	0	0
N.C.L.B.	Left	0	X	X	X	X
N.C.L.B.	Right	X	0	X	X	X
N.C.L.B.	Center	0	0	X	X	X
N.C.E.B.	Left	0	0	0	0	X
N.C.E.B.	Right	0	0	0	X	0

Note: X = Closed / 0 = Open

Technical Diagram