

# Catalogue No: **D7-ATR02**

## RESET ROD 55mm ADJUSTABLE 50-67mm FOR D7

Operator Control Devices > Pushbuttons and Control Switches > Pushbuttons and Pilot Lights > Sprecher + Schuh D7 Pushbuttons and Pilot Lights > D7 Reset Rod Operators > Reset Rods



### Reset rod 55mm for D7



Representative Photo Only  
(actual product may vary based on configuration selections)

- D7 pilot devices offer maximum flexibility and a wide choice for all 22.5mm operator applications with all type (e-stops, selector switches, pushbuttons, pilot lights and more), colour and contact configurations.
- Aesthetically appealing and modularly designed to make assembly and interchangeability easy.
- Operators exhibit low profile and stylish appearance while maintaining the rugged performance necessary for demanding environments
- D7P is a plastic operator with a captive black plastic front bezel. Constructed of high-grade thermoplastics, the D7P is suitable for almost all environments and strong chemical resistance.
- D7M has a die-cast zinc housing and mounting ring for rugged durability. Finished with corrosion resistant chrome plating, the D7M also features a captive shiny metal bezel for a polished appearance.

### SPECIFICATIONS

Component Type Pushbutton and Pilot Lights	Reset Rod
Operator Type	Reset Rod Operator type
Length, Shaft	55 mm
Length, Adjustable, Min	50 mm
Length, Adjustable, Max	67 mm
Electrical Service Life at Un, In	500000 cycles
Mechanical Service Life	10000000 cycles
RoHS Approved	Yes
CE Marked	Yes
Operating Temperature, Max	70 °C max
Operating Temperature, Min	-25 °C min
Storage Temperature, Max	85 °C max
Storage Temperature, Min	-25 °C min
Relative humidity, min	50 %RH
Relative Humidity, Max	95 %RH
IP Rating	IP66 IP65
Shock Acceleration (Max.)	100 g
Shock Duration (Max.)	11 ms
Vibration Acceleration (Max.)	10 m/s <sup>2</sup>
Vibration Displacement (Peak to Peak Max.)	1.52 mm
Vibration Frequency, Operational (Max.)	2000 Hz
Vibration Duration (Max.)	180 min
Standards Compliance	NEMA ICS-5 UL 508 EN 60947-1 EN 60947-5-1 EN 60947-5-5 EN 418

# Catalogue No: **D7-ATR02**

## RESET ROD 55mm ADJUSTABLE 50-67mm FOR D7

Operator Control Devices > Pushbuttons and Control Switches > Pushbuttons and Pilot Lights > Sprecher + Schuh D7 Pushbuttons and Pilot Lights > D7 Reset Rod Operators > Reset Rods



Certifications	UL UR CSA CCC CE
Shipping Approvals	RINA (Registro Italiano Navale) ABS (American Bureau of Shipping) Lloyd's Register of Shipping

### REFERENCES

IECEX Certificate	-
Supplier Declaration of Conformity:	-
Installation Guide:	-
User Manual:	-
Manufacturer Datasheet:	<a href="#">Series D7 Manufacturer Datasheet</a>
Manufacturer Catalogue & Product Selection:	-

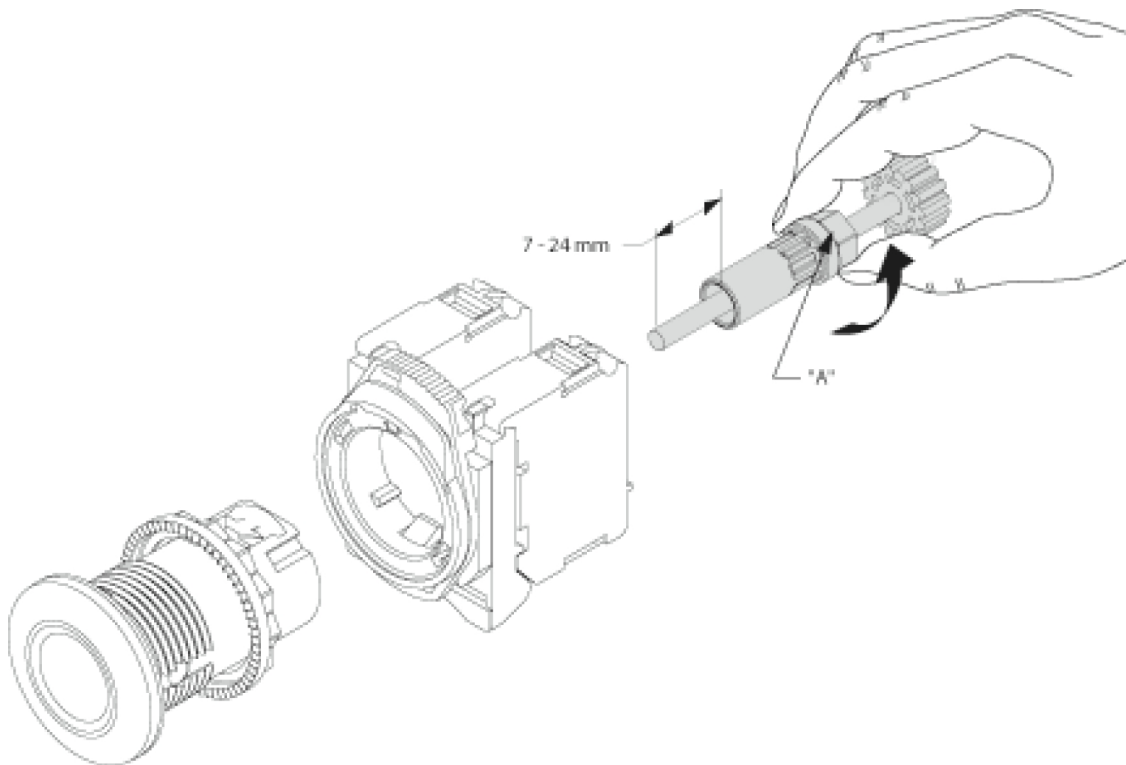

Dimension Diagram