



Technical catalogue - Edition 2011

System pro *M* compact[®] DIN Rail components for low voltage installation

SUMMARY

Introduction	1	
Miniature circuit-breakers	2	
Residual current devices	3	
Auxiliary elements and accessories	4	
Other modular devices	Protection devices	5
	Command devices	6
	Load management devices	7
	Measurement devices	8
	Other functions	9
	Plug-in systems	10
Technical details	11	
Application sheets	12	
Overall dimensions	13	
Worldwide marks and approvals	14	

System pro M compact® News

1

The product range is growing and growing.
New functions, new characteristics, new possibilities.



F2C-ARH-T

The new autoreclosing unit for domestic and similar application F2C-ARH-T periodically performs the auto test of the associated 2P RCCB F202 30 mA.



MeMo4

A new memory size is available for the MeMo range of modular data memories: MeMo4 with 4 GB of storage available.



SPD+MCB

The OVR Plus range (SPD+MCB) is now complete with the 3Ph+N version in 15 and 40kA (I_{max}). Also available in 1Ph+N version, the compact OVR Plus range cover now all applications from domestic to industrial.



ANR96PRF

The ANR range of network analyzers has been widened with the introduction of two versions, ANR96PRF-24 and ANR96PRF-230, with Profibus DP protocol built in.



CTO

The range of current transformers for measurement devices has been broadened with CTO split core current transformer with through primary: this type of current transformers is typically used in distribution panels or power centers for maintenance reasons or system enlargement. They can be installed easily and they allow to save a lot of time, avoiding bar disconnection.



Modular sockets

New modular sockets to be used worldwide:

- M1363 to take the British standard BS1363 plugs up to 13 A;
- M1176 to take Australian/New Zealand standard AS/NZS 3112 plugs up to 10 A and 15 A;
- M2071 to take Argentine standard IRAM 2071 plugs up to 10 A.



EPD24

The protection devices EPD24 extend the ABB product range of modular DIN rail components by electronic overcurrent protection modules for selective protection of 24V DC load circuits. If a fault occurs in a load circuit, the protection device EPD24 will detect this rapidly and reliably, disable the power output transistor and hence interrupt the current flow in the defective circuit.

System pro M compact® Presentation

1

A wide product range suitable for all applications

For all applications in residential, industrial and commercial installations ABB System pro M compact® range offers many functionalities like:

- protection and switching
- checking and monitoring
- control and programming

Moreover, shape and dimensions of the devices allow a perfect integration in existing installations.

The technologically innovative bidirectional cylinder-lift terminal available in the System pro M compact® devices enables synchronous closing of the front and rear wiring input.

Highest safety standard for the installer thanks to protection against electric shock according to EN 41140.

Marking of devices is reliable and clear.

Both supply and connection with busbars from top or bottom is admitted.

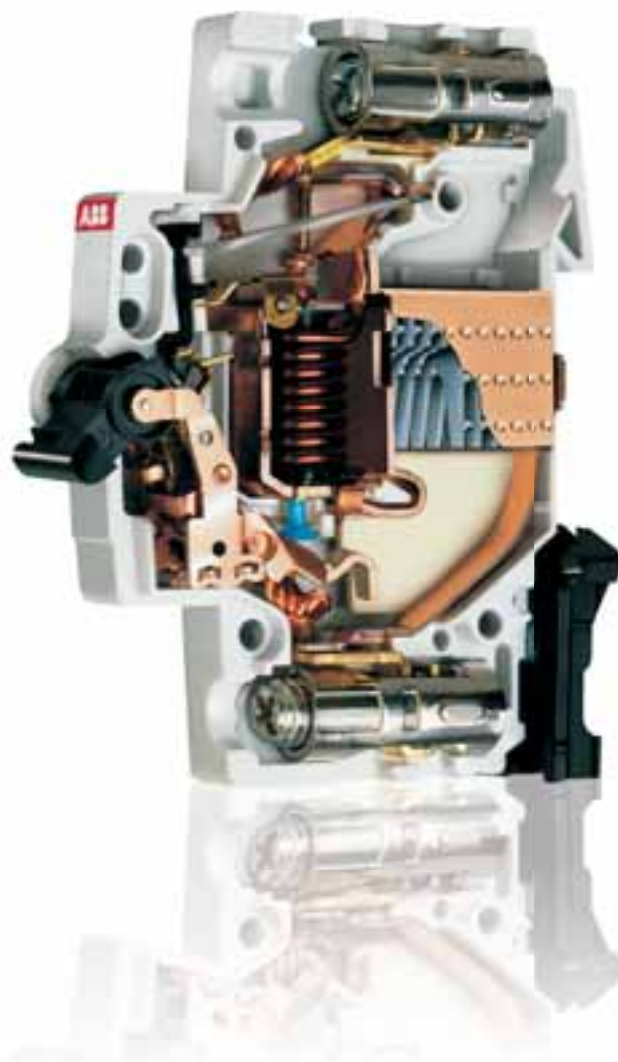

The System pro M compact® range

MCBs

Miniature circuit-breakers.

RCDs

- Residual current circuit-breakers (RCCBs);
- RCD-blocks;
- Residual current circuit-breakers with overcurrent protection (RCBOs);
- Residual current relays (modular and front panel) with external toroid.

Auxiliary elements

A whole range of accessories and auxiliary elements.

SPDs

Surge protective devices.

Protection devices

In addition to MCBs and RCDs, ABB supplies other modular devices for protection such as fuse holders, fuses, switch disconnectors, insulation monitoring devices etc.

Command devices

This category includes devices that are operated manually to command the electric system: contactors, latching relays, switch-isolators, switches, pushbuttons etc. Typically they are installed to control lights from several points of the same circuit or to pilot user devices with a high number of operations.

Load management devices

Overload relays, load management switches, anti black-out lamps, time switches and the other modular devices in this category react automatically to variations of parameters and other events in the system to allow for plant optimisation.

Measurement devices

The range of devices in this category is very wide, including a great number of auxiliary components and accessories that make installation in switchboards and consumer units practical and economic.

Other devices

The System pro M compact® range also includes bells, transformers, modular sockets etc.

Various accessories



System pro M compact[®]

Advantages

1

The System pro M compact[®] range offers enormous advantages in relation to installation.

Advanced and smart solutions allow a far easier and safer installation and guarantee time saving.



MCBs are also available with an integrated auxiliary contact (1 NO or 1 NC). Existing installations can be easily upgraded to include auxiliary switch functionality.



RCD-blocks DDA 200 2P, 3P, 4P up to 40 A fit into two modules. Versions in 63 A sizes are supplied with two additional terminals for remote tripping.



Safety connections between DDA 200 and S 200 thanks to a safe plastic key system.



Availability of a wide range of RCBOs.



Universal signal/auxiliary and auxiliary contacts fit on S 200, F 200 and DS 200.



Supply from top or bottom either with cables or busbars.

The bi-directional cylinder-lift terminal allows easier and quicker connections. In addition it avoids errors because it prevents the use of free cable seats.

This high protection level against errors eliminates right from the start industrial accidents deriving from incorrect wiring.

The terminal guarantees a very high tightening torque for cables with a section up to 25 mm².

The housing of connection busbars in the rear seat guarantees easier wiring.



Safe terminal technology: the terminals offer protection from misconnection.



Error proof terminals: they avoid the use of free cable seats.



Supply from top or bottom also possible with busbars.



Without busbars two terminal spaces can be used for cables with different cross sections: incoming supply with supplementary terminal up to 50 mm² from the front side.



Special quick fastening for an easy removal of the devices from the assembly pressing upwards, both for MCBs S 200 and RCCBs F 200: the only in the market that can be removed without a screwdriver.



More working space between component rows.



2CSC400133F0201



2CSC400395F0201



2CSC400259F0201



2CSC400556F0201



Index

General features and breaking capacities	2/2
S 200 System pro <i>M</i> compact MCBs	2/5
SN 201 MCBs 1P+N in 1 module	2/49
S 280, S 290, S700, S800 and S500 MCBs	2/57

System pro M compact® and breaking capacities

General features

MCBs

NOTE: All the MCBs of S200 series present two values of breaking capacities marked on the product: on the front I_{cu} according to IEC/EN 60898 on the side I_{cs} according to IEC/EN 60947-2 depending on the rated current, if not otherwise specified.



Series		S 200	S 200 M	S 200 P		S 200 U	S 200 UP	SN 201 L	SN 201	SN 201 M	S 280				
Characteristics		B,C,D, K,Z	B,C,D, K,Z	B,C,D, K,Z	B,C,D, K,Z	B,C,D, K,Z	K,Z	K,Z	K,Z	B,C	B,C,D	B,C	B,C		
Rated current	[A]	0.5 ≤ In ≤ 63	0.5 ≤ In ≤ 63	0.2 ≤ In ≤ 25	32 ≤ In ≤ 40	50 ≤ In ≤ 63	0.2 ≤ In ≤ 25	32 ≤ In ≤ 40	50 ≤ In ≤ 63	0.2 ≤ In ≤ 25	2 ≤ In ≤ 40	2 ≤ In ≤ 40	80 ≤ In ≤ 100		
Breaking capacity	[kA]														
Reference standard	Nr. poles	Ue[V]													
IEC 23-3/EN 60898 IEC/EN 60947-2 Alternating current	I_{cn}	230/400	6	10	25	15	15				4.5	6	10	6	
	I_{cu} 1, 1P+N	133	20	25 ^②	40	25	25	40	25	25	40	10	15	20	15
		230	10	15 ^②	25	15	15	25	15	15	25	6	10	10	6
		2, 3, 4	230	20	25 ^②	40	25	25	40	25	25	40			10
		400	10	15 ^②	25	15	15	25	15	15	25			6	
	I_{cs} 1, 1P+N	690													
		133	15	18.7 ^②	20	18.7	18.7	20	18.7	18.7	20	6	10	10	15
		230	7.5	11.2 ^②	12.5	11.2	7.5	12.5	11.2	7.5	12.5	4.5	6	7.5	6
		2, 3, 4	230	15 ^①	18.7 ^②	20	18.7	18.7	20	18.7	18.7	20			10
	IEC/EN 60947-2 Direct current T=I/R≤5ms for all series, except S280 UC and S800S-UC, where T=I/R<15ms	I_{cu} 1, 1P+N	400	7.5	11.2 ^②	12.5	11.2	7.5	12.5	11.2	7.5	12.5			6
500															
690															
24			20												
2		60	10	10	15	10	10	15	10	10	15	10	15	15	10
		125													
		250													
		48	20												
3,4		125	10	10	15	10	10	15	10	10	15	10	15	15	10
		250													
	500														
	600														
I_{cs} 1, 1P+N	800														
	375														
	500														
	750														
2	1000														
	1200														
	24	20													
	60	10	10	15	10	10	15	10	10	15	10	15	15	10	
3,4	125														
	250														
	48	20													
	125	10	10	15	10	10	15	10	10	15	10	15	15	10	
UL 1077/ C22.2 No 235 Alternating current	cap.	240	10		10	10	10								
		277	6		10	10	10								
		480Y/277	6		10	10	10								
		240	10		10	10	10								
UL 1077/ C22.2 No 235 Direct current	cap.	Int. 1, 1P+N	60	10											
		2, 3, 4	125	10											
UL 489/ C22.2 No 5 Alternating current	cap.	Int. 1	240				10	10	10	10					
		2, 3, 4	277												
		240					10	10	10	10					
		480Y/277									10				
IEC/EN 60947-3	I_{cw}	2	800												
		3, 4	1200												

① only up to 40 A; 10 kA up to 50/63 A ② only for "D" characteristic ③ values are not for all rated currents ④ 600 V DC for 100, 125 A ⑤ 1000 V DC for 100, 125 A

MCBs protect installations against overload and short-circuit, warranting reliability and safety for operations.

New System pro *M* compact S 200 series satisfies most common requirements in terms of MCBs, allowing the usage of them for domestic, industrial and commercial applications.

Three series – **S 200**, **S 200 M** and **S 200 P** – with three different breaking capacities up to 25 kA are available, in all characteristics (B, C, D, K and Z) and configurations (1P, 1P+N, 2P, 3P, 3P+N and 4P), in all the sizes up to 63 A.

All these MCBs comply to IEC/EN 60898 and IEC/EN 60947-2 Standards. The range includes also the new **S 200 U** and **S 200 UP** in accordance to UL 489/CSA-C22.2 N 05 Standard.

It is also available the new integrated auxiliary contact on the bottom side which permits to save 50% space.

Thought to be advanced, MCBs range also offers all the “plus” advantages which characterized the whole new System pro *M* compact range.

S 200 series devices obtained a lot of marks and approvals, so they can be used in all world's markets.

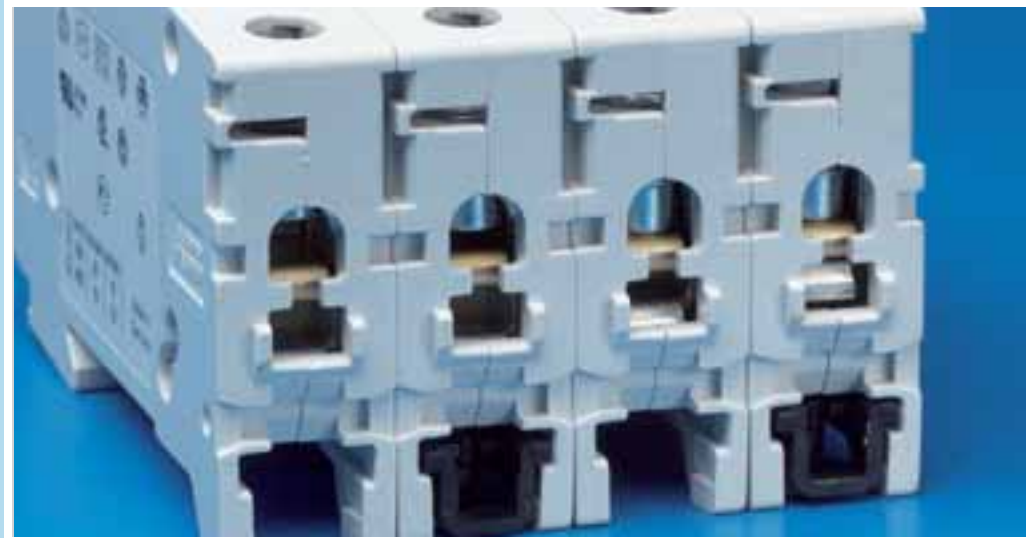

2CSC400230F0201



2CSC400261F0201



2CSC400260F0201



2CSC400259F0201



Index

Technical features of MCBs S 200 series	2/6
---	-----

Selection tables of MCBs S 200 series

S 200-B	2/8
S 200-C	2/10
S 200-D	2/12
S 200-K	2/14
S 200-Z	2/16
S 200 M-B	2/18
S 200 M-C	2/20
S 200 M-D	2/22
S 200 M-K	2/24
S 200 M-Z	2/26
S 200 P-B	2/28
S 200 P-C	2/30
S 200 P-D	2/32
S 200 P-K	2/34
S 200 P-Z	2/36

Selection tables of MCBs S 200 in accordance to UL 489/CSA-C22.2 N 05

S 200 U-K	2/38
S 200 U-Z	2/40
S 200 UP-K	2/42
S 200 UP-Z	2/44
S 200 UDC-K	2/46
S 200 UDC-Z	2/47

Electrical Data	Standards	IEC/EN UL/CSA		
	Poles			
	Tripping characteristics			
	Rated current I_n		A	
	Rated voltage U_n	IEC/EN 60898-1	V	
	Rated voltage U_g	IEC/EN 60947-2	V	
	Rated voltage	UL/CSA	V	
	Insulation voltage U_i	IEC/EN 60898-1 / 60947-2	V	
	Max. operating voltage U_{Bmax}		V	
	Min. operating voltage U_{Bmin}		V	
	Rated frequency f		Hz	
	Rated short-circuit capacity I_{cn}	IEC/EN 60898-1	kA	
	Ultimate short-circuit capacity I_{cu}	IEC/EN 60947-2	kA	
	Service short-circuit capacity I_{cs}	IEC/EN 60947-2	kA	
	Rated interrupting capacity	UL 1077, CSA 22.2 No. 235	kA	
	Short-circuit current rating SCCR	UL 489, CSA 22.2 No. 5	kA	
	Energy limiting class	IEC/EN 60898-1		
	Overtoltage category	IEC/EN 60898-1 / 60947-2		
	Pollution degree	IEC/EN 60898-1 IEC/EN 60947-2		
	Rated impulse withstand voltage U_{imp} (1.2/50 μ s)	IEC/EN 60898-1 / 60947-2	kV	
	Dielectric test voltage	IEC/EN 60898-1	kV	
	Mechanical Data	Housing		
		Toggle		
Contact position indication				
Protection degree		EN 60529		
Electrical endurance			ops.	
Mechanical endurance			ops.	
Shock resistance		IEC/EN 60068-2-27		
Vibration resistance		IEC/EN 60068-2-6		
Tropicalization (damp heat cyclic)		IEC/EN 60068-2-30	°C/RH	
Ambient temperature			°C	
Storage temperature			°C	
Reference temperature for tripping characteristics		IEC/EN 60898-1 IEC/EN 60947-2	°C	
Installation		Terminal		
	Cross-section of conductors (top / bottom)	IEC/EN 60898-1 / 60947-2 UL/CSA	mm ² AWG	
	Cross-section of busbars (top / bottom)	IEC/EN 60898-1 / 60947-2 UL/CSA	mm ² AWG	
	Torque	IEC/EN UL/CSA	Nm in-lbs.	
	Screwdriver			
	Mounting			
	Mounting position			
	Supply			
Dimensions and weight	Mounting dimensions	DIN 43880		
	Pole dimensions (H x D x W)		mm	
	Pole weight		g	
Combination with aux. elements	Auxiliary contact			
	Signal contact/auxiliary switch			
	Shunt trip			
	Undervoltage release			

System pro M compact® MCBs S 200 series

S 200



2

S 200	S 200 M	S 200 P	S 200 U	S 200 UP	S 200 UDC
IEC/EN 60898-1, IEC/EN 60947-2 UL 1077, CSA 22.2 No. 235	IEC/EN 60898-1, IEC/EN 60947-2 –	IEC/EN 60898-1, IEC/EN 60947-2 UL 1077, CSA 22.2 No. 235	IEC/EN 60947-2 UL 489, CSA 22.2 No.5		– UL 489
1P, 2P, 3P, 4P, 1P+N, 3P+N B, C, D, K, Z			1P, 2P, 3P, 4P		1P, 2P
0.5...63 A		0.2...63 A	0.2...63 A	0.2...25 A K, Z	1...63 A
1P: 230/400 V AC; 1P+N: 230 V AC; 2...4P: 400 V AC; 3P+N: 400 V AC 1P: 230 V AC; 1P+N: 230 V AC; 2...4P: 400 V AC; 3P+N: 400 V AC			1P: 230 V AC; 2...4P: 400 V AC		–
480Y / 277 V AC	–	480Y / 277 V AC	1P: 240 V AC 2...4P: 240 V AC	1P: 277 V AC 2...4P: 480Y / 277 V AC	1P: 60 V DC 2P: 125 V DC
250 V AC (phase to ground), 500 V AC (phase to phase)			1P: 253/440 V AC; 2...4P: 440 V AC		–
1P: 253 V AC; 1P+N: 253 V AC; 2P: 440 V AC; 3...4P: 440 V AC; 3P+N: 440 V AC 1P: 72 V DC; 2P: 125 V DC 12 V AC - 12 V DC			12 V AC		12 V DC DC
6 kA	10 kA	50 / 60 Hz ≤ 25 A: 25 kA > 25 A: 15 kA	–		–
10 kA	≤ 40 A: 15 kA 50, 63 A: 10 kA	≤ 25 A: 25 kA ≥ 32 A: 15 kA	10 kA		–
7.5 kA	≤ 40 A: 11.2 kA 50, 63 A: 7.5 kA	≤ 25 A: 12.5 kA ≤ 32...40 A: 11.2 kA 50, 63 A: 7.5 kA	7.5 kA		–
6 kA	–	10 kA	–		–
–	–	–	10 kA		14 kA (UL)
–	3	–	–		–
–	2	–	–		–
–	–	3	–		–
–	–	4 kV (test voltage 6.2 kV at sea level, 5 kV at 2,000 m) 2 kV (50 / 60Hz, 1 min.)	–		–
Insulation group I, RAL 7035			Insulation group II, black, sealable		
Marking on toggle, I ON / 0 OFF		Marking on toggle (I ON / 0 OFF), Real CPI (red ON / green OFF)			
IP20 / IPXXB, IP40 in enclosure with cover			IP20 / IPXXB, IP40 in enclosure with cover		
$I_n < 32$ A: 20,000 ops AC, $I_n \geq 32$ A: 10,000 ops. AC 1,000 ops. DC			20,000 ops. 30 g - 3 shocks - 11 ms 5g - 20 cycles at 5...150...5 Hz with load 0.8I _n 28 cycles with 55°C/90-96% and 25°C/95-100% -25 ... +55°C -40 ... +70°C		6,000 ops.
B, C, D: 30°C K, Z: 20°C		25°C (UL/CSA)		25°C (UL)	
Failsafe bi-directional cylinder-lift terminal					
18 - 4 AWG	–	25 mm ² / 25 mm ²	18 - 4 AWG		–
18 - 8 AWG	–	10 mm ² / 10 mm ²	18 - 8 AWG		–
25 in-lbs.	–	2.8 Nm	25 in-lbs.		–
No. 2 Pozidrive On DIN rail 35 mm acc. to EN 60715 by fast clip any					
optional				Please note polarity of device	
Mounting dimension 1 88 x 69 x 17.5 mm			92 x 71 x 17.5 mm	100 x 71 x 17.5 mm	92 x 71 x 17.5 mm
ca. 125 g			ca. 140 g		
Yes			Yes Yes Yes		
–			no		

6000

B

2

S 200 B characteristic

Function: protection and control of the circuits against overloads and short-circuits; protection for people and big length cables in TN and IT systems.

Applications: residential, commercial and industrial.

Standard: IEC/EN 60898, IEC/EN 60947-2

I_{cn}=6 kA

Number of poles	Rated current In A	Order details Type code	Order code	Bbn	Price 1 piece	Price group	Weight 1 piece kg	Pack unit pc.
				4016779				
1	6	S 201-B 6	2CDS 251 001 R0065	46490 1	253 V ~ 72 V ...		0.125	10
	10	S 201-B 10	2CDS 251 001 R0105	46380 5				
	13	S 201-B 13	2CDS 251 001 R0135	46500 7				
	16	S 201-B 16	2CDS 251 001 R1165	57863 9				
	20 ①	S 201-B 20	2CDS 251 001 R0205	46510 6				
	25	S 201-B 25	2CDS 251 001 R0255	46520 5				
	32 ②	S 201-B 32	2CDS 251 001 R0325	46530 4				
	40 ③	S 201-B 40	2CDS 251 001 R0405	46540 3				
	50	S 201-B 50	2CDS 251 001 R0505	55092 5				
	63	S 201-B 63	2CDS 251 001 R0635	55093 2				
	2	6	S 202-B 6	2CDS 252 001 R0065				
10		S 202-B 10	2CDS 252 001 R0105	46660 8				
13		S 202-B 13	2CDS 252 001 R0135	46670 7				
16		S 202-B 16	2CDS 252 001 R0165	46690 5				
20		S 202-B 20	2CDS 252 001 R0205	46700 1				
25		S 202-B 25	2CDS 252 001 R0255	46710 0				
32		S 202-B 32	2CDS 252 001 R0325	46720 9				
40		S 202-B 40	2CDS 252 001 R0405	46740 7				
50		S 202-B 50	2CDS 252 001 R0505	55094 9				
63		S 202-B 63	2CDS 252 001 R0635	55095 6				
3		6	S 203-B 6	2CDS 253 001 R0065	46860 2	440 V ~		0.375
	10	S 203-B 10	2CDS 253 001 R0105	46870 1				
	13	S 203-B 13	2CDS 253 001 R0135	46890 9				
	16	S 203-B 16	2CDS 253 001 R0165	46900 5				
	20 ①	S 203-B 20	2CDS 253 001 R0205	46910 4				
	25	S 203-B 25	2CDS 253 001 R0255	46920 3				
	32 ②	S 203-B 32	2CDS 253 001 R0325	46930 2				
	40 ③	S 203-B 40	2CDS 253 001 R0405	46940 1				
	50	S 203-B 50	2CDS 253 001 R0505	55096 3				
	63	S 203-B 63	2CDS 253 001 R0635	55097 0				
	4	6	S 204-B 6	2CDS 254 001 R0065	52895 5			
10		S 204-B 10	2CDS 254 001 R0105	52896 2				
13		S 204-B 13	2CDS 254 001 R0135	52897 9				
16		S 204-B 16	2CDS 254 001 R0165	52898 6				
20		S 204-B 20	2CDS 254 001 R0205	52899 3				
25		S 204-B 25	2CDS 254 001 R0255	52900 6				
32		S 204-B 32	2CDS 254 001 R0325	52901 3				
40		S 204-B 40	2CDS 254 001 R0405	52902 0				
50		S 204-B 50	2CDS 254 001 R0505	55098 7				
63		S 204-B 63	2CDS 254 001 R0635	55099 4				

① suitable for flow-type heaters 12 kW
② suitable for flow-type heaters 18 kW

③ suitable for flow-type heaters 21, 24 and 27 kW
④ U_{Bmax} 125 V ... with 2 poles connected in series

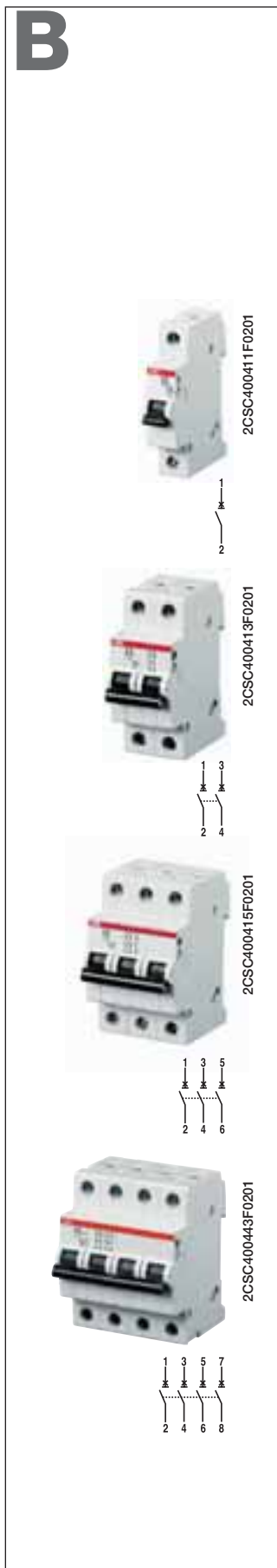

6000

B



2CSC400421F0201



2CSC400418F0201



With disconnecting neutral NA

Number of poles	Rated current In A	Order details Type code	Order code	Bbn 4016779	Price 1 piece	Price group	Weight 1 piece kg	Pack unit pc.
1 + NA	6	S 201-B 6 NA	2CDS 251 103 R0065	53158 0			0.250	5
	10	S 201-B 10 NA	2CDS 251 103 R0105	53159 7			0.250	5
	13	S 201-B 13 NA	2CDS 251 103 R0135	53160 3			0.250	5
	16	S 201-B 16 NA	2CDS 251 103 R0165	53161 0			0.250	5
	20 ①	S 201-B 20 NA	2CDS 251 103 R0205	53162 7			0.250	5
	25	S 201-B 25 NA	2CDS 251 103 R0255	53163 4			0.250	5
	32 ②	S 201-B 32 NA	2CDS 251 103 R0325	53164 1			0.250	5
	40 ③	S 201-B 40 NA	2CDS 251 103 R0405	53165 8			0.250	5
	50	S 201-B 50 NA	2CDS 251 103 R0505	53615 8			0.250	5
	63	S 201-B 63 NA	2CDS 251 103 R0635	53614 1			0.250	5
U_{Bmax} 253 V ~ 72 V ...								
3 + NA	6	S 203-B 6 NA	2CDS 253 103 R0065	53228 0			0.500	1
	10	S 203-B 10 NA	2CDS 253 103 R0105	53229 7			0.500	1
	13	S 203-B 13 NA	2CDS 253 103 R0135	53230 3			0.500	1
	16	S 203-B 16 NA	2CDS 253 103 R0165	53231 0			0.500	1
	20 ①	S 203-B 20 NA	2CDS 253 103 R0205	53232 7			0.500	1
	25	S 203-B 25 NA	2CDS 253 103 R0255	53233 4			0.500	1
	32 ②	S 203-B 32 NA	2CDS 253 103 R0325	53234 1			0.500	1
	40 ③	S 203-B 40 NA	2CDS 253 103 R0405	53235 8			0.500	1
	50	S 203-B 50 NA	2CDS 253 103 R0505	53616 5			0.580	1
	63	S 203-B 63 NA	2CDS 253 103 R0635	53617 2			0.580	1
U_{Bmax} 440 V ~								

- ① suitable for flow-type heaters 12 kW
② suitable for flow-type heaters 18 kW

- ③ suitable for flow-type heaters 21, 24 and 27 kW

2

6000

C



2CSC400408F0201



2CSC400409F0201



2CSC400412F0201



S 200 C characteristic

Function: protection and control of the circuits against overloads and short-circuits; protection for resistive and inductive loads with low inrush current.

Applications: residential, commercial and industrial.

Standard: IEC/EN 60898, IEC/EN 60947-2

Icn=6 kA

Number of poles	Rated current	Order details	Bbn 4016779	Price 1 piece	Price group	Weight 1 piece kg	Pack unit pc.
In A	Type code	Order code	EAN				
1	0.5	S 201-C 0.5	2CDS 251 001 R0984	52329 5		0.125	10
	1	S 201-C 1	2CDS 251 001 R0014	52331 8		0.125	10
	1.6	S 201-C 1.6	2CDS 251 001 R0974	52330 1		0.125	10
	2	S 201-C 2	2CDS 251 001 R0024	52332 5		0.125	10
	3	S 201-C 3	2CDS 251 001 R0034	52333 2		0.125	10
	4	S 201-C 4	2CDS 251 001 R0044	52334 9		0.125	10
	6	S 201-C 6	2CDS 251 001 R0064	46400 0		0.125	10
	8	S 201-C 8	2CDS 251 001 R0084	46410 9		0.125	10
	10	S 201-C 10	2CDS 251 001 R0104	46420 8		0.125	10
	13	S 201-C 13	2CDS 251 001 R0134	46430 7		0.125	10
	16	S 201-C 16	2CDS 251 001 R0164	46440 6		0.125	10
	20 ①	S 201-C 20	2CDS 251 001 R0204	46450 5		0.125	10
	25	S 201-C 25	2CDS 251 001 R0254	46460 4		0.125	10
	32 ②	S 201-C 32	2CDS 251 001 R0324	46470 3		0.125	10
	40 ③	S 201-C 40	2CDS 251 001 R0404	46480 2		0.125	10
50	S 201-C 50	2CDS 251 001 R0504	55100 7		0.125	10	
63	S 201-C 63	2CDS 251 001 R0634	55101 4		0.125	10	
U_{Bmax} 253 V ~ 72 V ...							
2	0.5	S 202-C 0.5	2CDS 252 001 R0984	52335 6		0.250	5
	1	S 202-C 1	2CDS 252 001 R0014	52336 3		0.250	5
	1.6	S 202-C 1.6	2CDS 252 001 R0974	52337 0		0.250	5
	2	S 202-C 2	2CDS 252 001 R0024	52338 7		0.250	5
	3	S 202-C 3	2CDS 252 001 R0034	52339 4		0.250	5
	4	S 202-C 4	2CDS 252 001 R0044	52340 0		0.250	5
	6	S 202-C 6	2CDS 252 001 R0064	46550 2		0.250	5
	8	S 202-C 8	2CDS 252 001 R0084	46560 1		0.250	5
	10	S 202-C 10	2CDS 252 001 R0104	46570 0		0.250	5
	13	S 202-C 13	2CDS 252 001 R0134	46580 9		0.250	5
	16	S 202-C 16	2CDS 252 001 R0164	46590 8		0.250	5
	20	S 202-C 20	2CDS 252 001 R0204	46600 4		0.250	5
	25	S 202-C 25	2CDS 252 001 R0254	46610 3		0.250	5
	32	S 202-C 32	2CDS 252 001 R0324	46620 2		0.250	5
	40	S 202-C 40	2CDS 252 001 R0404	46630 1		0.250	5
50	S 202-C 50	2CDS 252 001 R0504	55104 5		0.250	5	
63 ④	S 202-C 63	2CDS 252 001 R0634	55105 2		0.250	5	
U_{Bmax} 440 V ~ 125 V ...							
3	0.5	S 203-C 0.5	2CDS 253 001 R0984	52341 7		0.375	1
	1	S 203-C 1	2CDS 253 001 R0014	52342 4		0.375	1
	1.6	S 203-C 1.6	2CDS 253 001 R0974	52343 1		0.375	1
	2	S 203-C 2	2CDS 253 001 R0024	52344 8		0.375	1
	3	S 203-C 3	2CDS 253 001 R0034	52345 5		0.375	1
	4	S 203-C 4	2CDS 253 001 R0044	52346 2		0.375	1
	6	S 203-C 6	2CDS 253 001 R0064	46750 6		0.375	1
	8	S 203-C 8	2CDS 253 001 R0084	46760 5		0.375	1
	10	S 203-C 10	2CDS 253 001 R0104	46780 3		0.375	1
	13	S 203-C 13	2CDS 253 001 R0134	46790 2		0.375	1
	16	S 203-C 16	2CDS 253 001 R0164	46800 8		0.375	1
	20 ①	S 203-C 20	2CDS 253 001 R0204	46810 7		0.375	1
	25	S 203-C 25	2CDS 253 001 R0254	46820 6		0.375	1
	32 ②	S 203-C 32	2CDS 253 001 R0324	46830 5		0.375	1
	40 ③	S 203-C 40	2CDS 253 001 R0404	46840 4		0.375	1
50	S 203-C 50	2CDS 253 001 R0504	55106 9		0.375	1	
63	S 203-C 63	2CDS 253 001 R0634	55107 6		0.375	1	
U_{Bmax} 440 V ~							

6000

2

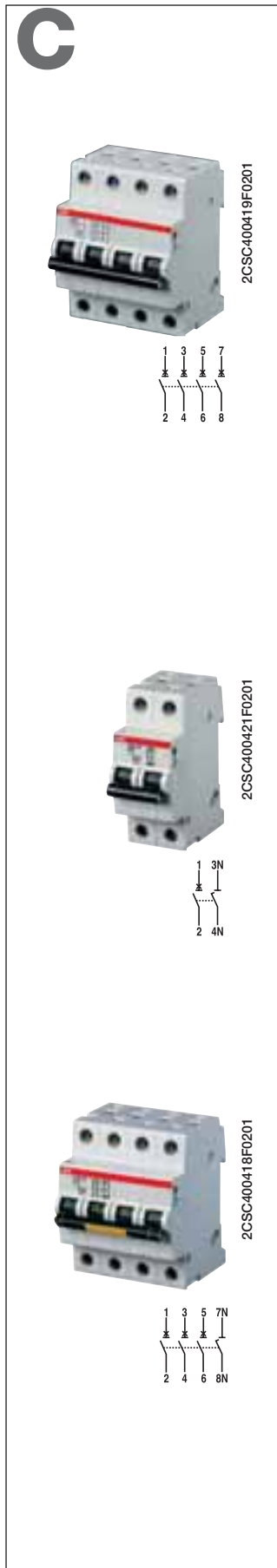

4	0.5	S 204-C	0.5	2CDS 254 001 R0984	52911 2	0.500	1
	1	S 204-C	1	2CDS 254 001 R0014	52912 9	0.500	1
	1.6	S 204-C	1.6	2CDS 254 001 R0974	52913 6	0.500	1
	2	S 204-C	2	2CDS 254 001 R0024	52914 3	0.500	1
	3	S 204-C	3	2CDS 254 001 R0034	52915 0	0.500	1
	4	S 204-C	4	2CDS 254 001 R0044	52916 7	0.500	1
	6	S 204-C	6	2CDS 254 001 R0064	52917 4	0.500	1
	8	S 204-C	8	2CDS 254 001 R0084	52918 1	0.500	1
	10	S 204-C	10	2CDS 254 001 R0104	52919 8	0.500	1
	13	S 204-C	13	2CDS 254 001 R0134	52920 4	0.500	1
	16	S 204-C	16	2CDS 254 001 R0164	52921 1	0.500	1
	20	S 204-C	20	2CDS 254 001 R0204	52922 8	0.500	1
	25	S 204-C	25	2CDS 254 001 R0254	52923 5	0.500	1
	32	S 204-C	32	2CDS 254 001 R0324	52924 2	0.500	1
U _{Bmax} 440 V ~ 125 V ...	40	S 204-C	40	2CDS 254 001 R0404	52925 9	0.500	1
	50	S 204-C	50	2CDS 254 001 R0504	55110 6	0.500	1
	63	S 204-C	63	2CDS 254 001 R0634	55111 3	0.500	1

- ① suitable for flow-type heaters 12 kW
- ② suitable for flow-type heaters 18 kW
- ③ suitable for flow-type heaters 21, 24 and 27 kW
- ④ U_{Bmax} 125 V ... with 2 poles connected in series

With disconnecting neutral NA

Number of poles	Rated current	Order details		Bbn 4016779	Price 1 piece	Price group	Weight 1 piece	Pack unit
		In A	Type code					
1 + NA	0.5	S 201-C	0.5 NA	2CDS 251 103 R0984	53166 5		0.250	5
	1	S 201-C	1 NA	2CDS 251 103 R0014	53167 2		0.250	5
	1.6	S 201-C	1.6 NA	2CDS 251 103 R0974	53168 9		0.250	5
	2	S 201-C	2 NA	2CDS 251 103 R0024	53169 6		0.250	5
	3	S 201-C	3 NA	2CDS 251 103 R0034	53170 2		0.250	5
	4	S 201-C	4 NA	2CDS 251 103 R0044	53172 6		0.250	5
	6	S 201-C	6 NA	2CDS 251 103 R0064	53173 3		0.250	5
	8	S 201-C	8 NA	2CDS 251 103 R0084	53174 0		0.250	5
	10	S 201-C	10 NA	2CDS 251 103 R0104	53175 7		0.250	5
	13	S 201-C	13 NA	2CDS 251 103 R0134	53176 4		0.250	5
	16	S 201-C	16 NA	2CDS 251 103 R0164	53177 1		0.250	5
	20 ①	S 201-C	20 NA	2CDS 251 103 R0204	53178 8		0.250	5
	25	S 201-C	25 NA	2CDS 251 103 R0254	53179 5		0.250	5
	32 ②	S 201-C	32 NA	2CDS 251 103 R0324	53180 1		0.250	5
U _{Bmax} 253 V ~ 72 V ...	40 ③	S 201-C	40 NA	2CDS 251 103 R0404	53181 8		0.250	5
	50	S 201-C	50 NA	2CDS 251 103 R0504	55102 1		0.290	5
	63	S 201-C	63 NA	2CDS 251 103 R0634	55103 8		0.290	5

3 + NA	0.5	S 203-C	0.5 NA	2CDS 253 103 R0984	53236 5	0.500	1
	1	S 203-C	1 NA	2CDS 253 103 R0014	53237 2	0.500	1
	1.6	S 203-C	1.6 NA	2CDS 253 103 R0974	53238 9	0.500	1
	2	S 203-C	2 NA	2CDS 253 103 R0024	53240 2	0.500	1
	3	S 203-C	3 NA	2CDS 253 103 R0034	53241 9	0.500	1
	4	S 203-C	4 NA	2CDS 253 103 R0044	53242 6	0.500	1
	6	S 203-C	6 NA	2CDS 253 103 R0064	53243 3	0.500	1
	8	S 203-C	8 NA	2CDS 253 103 R0084	53244 0	0.500	1
	10	S 203-C	10 NA	2CDS 253 103 R0104	53245 7	0.500	1
	13	S 203-C	13 NA	2CDS 253 103 R0134	53246 4	0.500	1
	16	S 203-C	16 NA	2CDS 253 103 R0164	53247 1	0.500	1
	20 ①	S 203-C	20 NA	2CDS 253 103 R0204	53248 8	0.500	1
	25	S 203-C	25 NA	2CDS 253 103 R0254	53249 5	0.500	1
	32 ②	S 203-C	32 NA	2CDS 253 103 R0324	53250 1	0.500	1
U _{Bmax} 440 V ~	40 ③	S 203-C	40 NA	2CDS 253 103 R0404	53251 8	0.500	1
	50	S 203-C	50 NA	2CDS 253 103 R0504	55108 3	0.580	1
	63	S 203-C	63 NA	2CDS 253 103 R0634	55109 0	0.580	1

- ① suitable for flow-type heaters 12 kW
- ② suitable for flow-type heaters 18 kW
- ③ suitable for flow-type heaters 21, 24 and 27 kW

6000

D

2



2CSC400408F0201



2CSC400409F0201



2CSC400412F0201



S 200 D characteristic

Function: protection and control of the circuits against overloads and short-circuits; protection for circuits which supply loads with high inrush current at the circuit closing (LV/LV transformers, breakdown lamps).

Applications: residential, commercial and industrial.

Standard: IEC/EN 60898, IEC/EN 60947-2

I_{cn}=6 kA

Number of poles	Rated current	Order details	Bbn 4016779	Price 1 piece	Price group	Weight 1 piece	Pack unit	
In A	Type code	Order code	EAN			kg	pc.	
1	0.5	S 201-D 0.5	2CDS 251 001 R0981	52993 8		0.125	10	
	1	S 201-D 1	2CDS 251 001 R0011	52994 5		0.125	10	
	1.6	S 201-D 1.6	2CDS 251 001 R0971	52995 2		0.125	10	
	2	S 201-D 2	2CDS 251 001 R0021	52996 9		0.125	10	
	3	S 201-D 3	2CDS 251 001 R0031	52997 6		0.125	10	
	4	S 201-D 4	2CDS 251 001 R0041	52998 3		0.125	10	
	6	S 201-D 6	2CDS 251 001 R0061	52999 0		0.125	10	
	8	S 201-D 8	2CDS 251 001 R0081	53000 2		0.125	10	
	10	S 201-D 10	2CDS 251 001 R0101	53001 9		0.125	10	
	13	S 201-D 13	2CDS 251 001 R0131	53002 6		0.125	10	
	16	S 201-D 16	2CDS 251 001 R0161	53003 3		0.125	10	
	20 ①	S 201-D 20	2CDS 251 001 R0201	53004 0		0.125	10	
	25	S 201-D 25	2CDS 251 001 R0251	53005 7		0.125	10	
	32 ②	S 201-D 32	2CDS 251 001 R0321	53006 4		0.125	10	
	40 ③	S 201-D 40	2CDS 251 001 R0401	53007 1		0.125	10	
U _{Bmax} 253 V ~ 72 V ...	50	S 201-D 50	2CDS 251 001 R0501	55199 1		0.125	10	
	63	S 201-D 63	2CDS 251 001 R0631	55200 4		0.125	10	
	2	0.5	S 202-D 0.5	2CDS 252 001 R0981	53048 4		0.250	5
		1	S 202-D 1	2CDS 252 001 R0011	53049 1		0.250	5
		1.6	S 202-D 1.6	2CDS 252 001 R0971	53050 7		0.250	5
		2	S 202-D 2	2CDS 252 001 R0021	53051 4		0.250	5
		3	S 202-D 3	2CDS 252 001 R0031	53052 1		0.250	5
4		S 202-D 4	2CDS 252 001 R0041	53053 8		0.250	5	
6		S 202-D 6	2CDS 252 001 R0061	53054 5		0.250	5	
8		S 202-D 8	2CDS 252 001 R0081	53055 2		0.250	5	
10		S 202-D 10	2CDS 252 001 R0101	53058 3		0.250	5	
13		S 202-D 13	2CDS 252 001 R0131	53060 6		0.250	5	
16		S 202-D 16	2CDS 252 001 R0161	53061 3		0.250	5	
20		S 202-D 20	2CDS 252 001 R0201	53063 7		0.250	5	
25		S 202-D 25	2CDS 252 001 R0251	53064 4		0.250	5	
32		S 202-D 32	2CDS 252 001 R0321	53065 1		0.250	5	
40		S 202-D 40	2CDS 252 001 R0401	53066 8		0.250	5	
U _{Bmax} 440 V ~ 125 V ...	50	S 202-D 50	2CDS 252 001 R0501	55203 5		0.250	5	
	63	S 202-D 63	2CDS 252 001 R0631	55204 2		0.250	5	
3	0.5	S 203-D 0.5	2CDS 253 001 R0981	53081 1		0.375	1	
	1	S 203-D 1	2CDS 253 001 R0011	53082 8		0.375	1	
	1.6	S 203-D 1.6	2CDS 253 001 R0971	53083 5		0.375	1	
	2	S 203-D 2	2CDS 253 001 R0021	53084 2		0.375	1	
	3	S 203-D 3	2CDS 253 001 R0031	53085 9		0.375	1	
	4	S 203-D 4	2CDS 253 001 R0041	53086 6		0.375	1	
	6	S 203-D 6	2CDS 253 001 R0061	53088 0		0.375	1	
	8	S 203-D 8	2CDS 253 001 R0081	53089 7		0.375	1	
	10	S 203-D 10	2CDS 253 001 R0101	53090 3		0.375	1	
	13	S 203-D 13	2CDS 253 001 R0131	53091 0		0.375	1	
	16	S 203-D 16	2CDS 253 001 R0161	53092 7		0.375	1	
	20 ①	S 203-D 20	2CDS 253 001 R0201	53093 4		0.375	1	
	25	S 203-D 25	2CDS 253 001 R0251	53094 1		0.375	1	
	32 ②	S 203-D 32	2CDS 253 001 R0321	53095 8		0.375	1	
	40 ③	S 203-D 40	2CDS 253 001 R0401	53096 5		0.375	1	
U _{Bmax} 440 V ~	50	S 203-D 50	2CDS 253 001 R0501	55205 9		0.375	1	
	63	S 203-D 63	2CDS 253 001 R0631	55206 6		0.375	1	

6000

2

D



2CSC400419F0201



4	0.5	S 204-D 0.5	2CDS 254 001 R0981	53112 2	0.500	1
	1	S 204-D 1	2CDS 254 001 R0011	53113 9	0.500	1
	1.6	S 204-D 1.6	2CDS 254 001 R0971	53114 6	0.500	1
	2	S 204-D 2	2CDS 254 001 R0021	53115 3	0.500	1
	3	S 204-D 3	2CDS 254 001 R0031	53116 0	0.500	1
	4	S 204-D 4	2CDS 254 001 R0041	53117 7	0.500	1
	6	S 204-D 6	2CDS 254 001 R0061	53118 4	0.500	1
	8	S 204-D 8	2CDS 254 001 R0081	53119 1	0.500	1
	10	S 204-D 10	2CDS 254 001 R0101	53120 7	0.500	1
	13	S 204-D 13	2CDS 254 001 R0131	53121 4	0.500	1
	16	S 204-D 16	2CDS 254 001 R0161	53122 1	0.500	1
	20	S 204-D 20	2CDS 254 001 R0201	53123 8	0.500	1
	25	S 204-D 25	2CDS 254 001 R0251	53129 0	0.500	1
	32	S 204-D 32	2CDS 254 001 R0321	53130 6	0.500	1
	40	S 204-D 40	2CDS 254 001 R0401	53131 3	0.500	1
	50	S 204-D 50	2CDS 254 001 R0501	55209 7	0.500	1
④	63	S 204-D 63	2CDS 254 001 R0631	55210 3	0.500	1

U_{Bmax}
440 V ~
125 V ...

- ① suitable for flow-type heaters 12 kW
- ② suitable for flow-type heaters 18 kW
- ③ suitable for flow-type heaters 21, 24 and 27 kW
- ④ U_{Bmax} 125 V ... with 2 poles connected in series

With disconnecting neutral NA



2CSC400421F0201



Number of poles	Rated current	Order details	Bbn 4016779	Price 1 piece	Price group	Weight 1 piece	Pack unit
	In A	Type code	Order code	EAN		kg	pc.
1	0.5	S 201-D 0.5 NA	2CDS 251 103 R0981	53197 9		0.250	5
+	1	S 201-D 1 NA	2CDS 251 103 R0011	53198 6		0.250	5
NA	1.6	S 201-D 1.6 NA	2CDS 251 103 R0971	53199 3		0.250	5
	2	S 201-D 2 NA	2CDS 251 103 R0021	53200 6		0.250	5
	3	S 201-D 3 NA	2CDS 251 103 R0031	53201 3		0.250	5
	4	S 201-D 4 NA	2CDS 251 103 R0041	53202 0		0.250	5
	6	S 201-D 6 NA	2CDS 251 103 R0061	53203 7		0.250	5
	8	S 201-D 8 NA	2CDS 251 103 R0081	53204 4		0.250	5
	10	S 201-D 10 NA	2CDS 251 103 R0101	53205 1		0.250	5
	13	S 201-D 13 NA	2CDS 251 103 R0131	53206 8		0.250	5
	16	S 201-D 16 NA	2CDS 251 103 R0161	53209 9		0.250	5
	20 ①	S 201-D 20 NA	2CDS 251 103 R0201	53210 5		0.250	5
	25	S 201-D 25 NA	2CDS 251 103 R0251	53211 2		0.250	5
	32 ②	S 201-D 32 NA	2CDS 251 103 R0321	53212 9		0.250	5
	40 ③	S 201-D 40 NA	2CDS 251 103 R0401	53213 6		0.250	5
	50	S 201-D 50 NA	2CDS 251 103 R0501	55201 1		0.290	5
	63	S 201-D 63 NA	2CDS 251 103 R0631	55202 8		0.290	5

U_{Bmax}
253 V ~
72 V ...



2CSC400418F0201



3	0.5	S 203-D 0.5 NA	2CDS 253 103 R0981	53276 1		0.500	2
+	1	S 203-D 1 NA	2CDS 253 103 R0011	53277 8		0.500	2
NA	1.6	S 203-D 1.6 NA	2CDS 253 103 R0971	53278 5		0.500	2
	2	S 203-D 2 NA	2CDS 253 103 R0021	53279 2		0.500	2
	3	S 203-D 3 NA	2CDS 253 103 R0031	53280 8		0.500	2
	4	S 203-D 4 NA	2CDS 253 103 R0041	53281 5		0.500	2
	6	S 203-D 6 NA	2CDS 253 103 R0061	53282 2		0.500	2
	8	S 203-D 8 NA	2CDS 253 103 R0081	53283 9		0.500	2
	10	S 203-D 10 NA	2CDS 253 103 R0101	53284 6		0.500	2
	13	S 203-D 13 NA	2CDS 253 103 R0131	53286 0		0.500	2
	16	S 203-D 16 NA	2CDS 253 103 R0161	53287 7		0.500	2
	20 ①	S 203-D 20 NA	2CDS 253 103 R0201	53288 4		0.500	2
	25	S 203-D 25 NA	2CDS 253 103 R0251	53289 1		0.500	2
	32 ②	S 203-D 32 NA	2CDS 253 103 R0321	53290 7		0.500	2
	40 ③	S 203-D 40 NA	2CDS 253 103 R0401	53291 4		0.500	2
	50	S 203-D 50 NA	2CDS 253 103 R0501	55207 3		0.580	2
	63	S 203-D 63 NA	2CDS 253 103 R0631	55208 0		0.580	2

U_{Bmax}
440 V ~

- ① suitable for flow-type heaters 12 kW
- ② suitable for flow-type heaters 18 kW
- ③ suitable for flow-type heaters 21, 24 and 27 kW

6000

K

S 200 K (power) characteristic

Function: protection and control of the circuits like motors, transformer and auxiliary circuits, against overloads and short-circuits.

Advantages: no nuisance tripping in the case of functional peak currents up to 10xI_n, depending on the series; through its highly sensitive thermostatic bimetal trip, the K-type characteristic offers protection to damageable elements in the overcurrent range; it also provides the best protection to cables and lines.

Applications: commercial and industrial.

Standard: IEC/EN 60947-2, VDE 0660 Part 101

I_{cu}=6 kA (acc. to VDE 0660 Part 101)



2CSC400414F0201



2CSC400416F0201



2CSC400417F0201

Number of poles	Rated current	Order details	Bbn	Price	Price group	Weight	Pack unit
	In A	Type code	Order code	EAN		kg	pc.
1	0.5	S 201-K 0.5	2CDS 251 001 R0157	50719 6		0.125	10
	1	S 201-K 1	2CDS 251 001 R0217	50720 2		0.125	10
	1.6	S 201-K 1.6	2CDS 251 001 R0257	50721 9		0.125	10
	2	S 201-K 2	2CDS 251 001 R0277	50722 6		0.125	10
	3	S 201-K 3	2CDS 251 001 R0317	50723 3		0.125	10
	4	S 201-K 4	2CDS 251 001 R0337	50724 0		0.125	10
	6	S 201-K 6	2CDS 251 001 R0377	50725 7		0.125	10
	8	S 201-K 8	2CDS 251 001 R0407	50726 4		0.125	10
	10	S 201-K 10	2CDS 251 001 R0427	49611 7		0.125	10
	13	S 201-K 13	2CDS 251 001 R0447	50727 1		0.125	10
	16	S 201-K 16	2CDS 251 001 R0467	49612 4		0.125	10
	20	S 201-K 20	2CDS 251 001 R0487	50728 8		0.125	10
	25	S 201-K 25	2CDS 251 001 R0517	50729 5		0.125	10
	32	S 201-K 32	2CDS 251 001 R0537	49613 1		0.125	10
	40	S 201-K 40	2CDS 251 001 R0557	50730 1		0.125	10
	50	S 201-K 50	2CDS 251 001 R0577	55112 0		0.125	10
	63	S 201-K 63	2CDS 251 001 R0607	55113 7		0.125	10
2	0.5	S 202-K 0.5	2CDS 252 001 R0157	50731 8		0.250	5
	1	S 202-K 1	2CDS 252 001 R0217	50732 5		0.250	5
	1.6	S 202-K 1.6	2CDS 252 001 R0257	50733 2		0.250	5
	2	S 202-K 2	2CDS 252 001 R0277	50734 9		0.250	5
	3	S 202-K 3	2CDS 252 001 R0317	50735 6		0.250	5
	4	S 202-K 4	2CDS 252 001 R0337	50736 3		0.250	5
	6	S 202-K 6	2CDS 252 001 R0377	50737 0		0.250	5
	8	S 202-K 8	2CDS 252 001 R0407	50738 7		0.250	5
	10	S 202-K 10	2CDS 252 001 R0427	50739 4		0.250	5
	13	S 202-K 13	2CDS 252 001 R0447	50740 0		0.250	5
	16	S 202-K 16	2CDS 252 001 R0467	50741 7		0.250	5
	20	S 202-K 20	2CDS 252 001 R0487	50742 4		0.250	5
	25	S 202-K 25	2CDS 252 001 R0517	50743 1		0.250	5
	32	S 202-K 32	2CDS 252 001 R0537	50744 8		0.250	5
	40	S 202-K 40	2CDS 252 001 R0557	50745 5		0.250	5
	50	S 202-K 50	2CDS 252 001 R0577	55116 8		0.250	5
	63	S 202-K 63	2CDS 252 001 R0607	55117 5		0.250	5
3	0.5	S 203-K 0.5	2CDS 253 001 R0157	50746 2		0.375	1
	1	S 203-K 1	2CDS 253 001 R0217	50747 9		0.375	1
	1.6	S 203-K 1.6	2CDS 253 001 R0257	50748 6		0.375	1
	2	S 203-K 2	2CDS 253 001 R0277	50749 3		0.375	1
	3	S 203-K 3	2CDS 253 001 R0317	50750 9		0.375	1
	4	S 203-K 4	2CDS 253 001 R0337	50751 6		0.375	1
	6	S 203-K 6	2CDS 253 001 R0377	50752 3		0.375	1
	8	S 203-K 8	2CDS 253 001 R0407	50753 0		0.375	1
	10	S 203-K 10	2CDS 253 001 R0427	49614 8		0.375	1
	13	S 203-K 13	2CDS 253 001 R0447	50754 7		0.375	1
	16	S 203-K 16	2CDS 253 001 R0467	49615 5		0.375	1
	20	S 203-K 20	2CDS 253 001 R0487	50755 4		0.375	1
	25	S 203-K 25	2CDS 253 001 R0517	50756 1		0.375	1
	32	S 203-K 32	2CDS 253 001 R0537	49616 2		0.375	1
	40	S 203-K 40	2CDS 253 001 R0557	50757 8		0.375	1
	50	S 203-K 50	2CDS 253 001 R0577	55118 2		0.375	1
	63	S 203-K 63	2CDS 253 001 R0607	55119 9		0.375	1

U_{Bmax}
253 V ~
72 V ...

U_{Bmax}
440 V ~
125 V ...

①

U_{Bmax}
440 V ~

6000

2

K



4	0.5	S 204-K 0.5	2CDS 254 001 R0157	52926 6	0.500	1
	1	S 204-K 1	2CDS 254 001 R0217	52927 3	0.500	1
	1.6	S 204-K 1.6	2CDS 254 001 R0257	52928 0	0.500	1
	2	S 204-K 2	2CDS 254 001 R0277	52929 7	0.500	1
	3	S 204-K 3	2CDS 254 001 R0317	52930 3	0.500	1
	4	S 204-K 4	2CDS 254 001 R0337	52931 0	0.500	1
	6	S 204-K 6	2CDS 254 001 R0377	52932 7	0.500	1
	8	S 204-K 8	2CDS 254 001 R0407	52933 4	0.500	1
	10	S 204-K 10	2CDS 254 001 R0427	52934 1	0.500	1
	13	S 204-K 13	2CDS 254 001 R0447	52935 8	0.500	1
	16	S 204-K 16	2CDS 254 001 R0467	52936 5	0.500	1
	20	S 204-K 20	2CDS 254 001 R0487	52937 2	0.500	1
	25	S 204-K 25	2CDS 254 001 R0517	52938 9	0.500	1
	32	S 204-K 32	2CDS 254 001 R0537	52939 6	0.500	1
	40	S 204-K 40	2CDS 254 001 R0557	52940 2	0.500	1
	U_{Bmax} 440 V ~	50	S 204-K 50	2CDS 254 001 R0577	55122 9	0.500
60 V ...		63	S 204-K 63	2CDS 254 001 R0607	55123 6	0.500

① U_{Bmax} 125 V ... with 2 poles connected in series

With disconnecting neutral NA



Number of poles	Rated current	Order details	Bbn 4016779	Price 1 piece	Price group	Weight 1 piece	Pack unit
	In A	Type code	Order code	EAN		kg	pc.
1 + NA	0.5	S 201-K 0.5 NA	2CDS 251 103 R0157	53182 5		0.250	5
	1	S 201-K 1 NA	2CDS 251 103 R0217	53183 2		0.250	5
	1.6	S 201-K 1.6 NA	2CDS 251 103 R0257	53184 9		0.250	5
	2	S 201-K 2 NA	2CDS 251 103 R0277	53185 6		0.250	5
	3	S 201-K 3 NA	2CDS 251 103 R0317	53186 3		0.250	5
	4	S 201-K 4 NA	2CDS 251 103 R0337	53187 0		0.250	5
	6	S 201-K 6 NA	2CDS 251 103 R0377	53188 7		0.250	5
	8	S 201-K 8 NA	2CDS 251 103 R0407	53189 4		0.250	5
	10	S 201-K 10 NA	2CDS 251 103 R0427	53190 0		0.250	5
	13	S 201-K 13 NA	2CDS 251 103 R0447	53191 7		0.250	5
	16	S 201-K 16 NA	2CDS 251 103 R0467	53192 4		0.250	5
	20	S 201-K 20 NA	2CDS 251 103 R0487	53193 1		0.250	5
	25	S 201-K 25 NA	2CDS 251 103 R0517	53194 8		0.250	5
	32	S 201-K 32 NA	2CDS 251 103 R0537	53195 5		0.250	5
	40	S 201-K 40 NA	2CDS 251 103 R0557	53196 2		0.250	5
	U_{Bmax} 253 V ~	50	S 201-K 50 NA	2CDS 251 103 R0577	55114 4		0.250
72 V ...		63	S 201-K 63 NA	2CDS 251 103 R0607	55115 1	0.250	5



3 + NA	0.5	S 203-K 0.5 NA	2CDS 253 103 R0157	53261 7		0.500	1
	1	S 203-K 1 NA	2CDS 253 103 R0217	53262 4		0.500	1
	1.6	S 203-K 1.6 NA	2CDS 253 103 R0257	53263 1		0.500	1
	2	S 203-K 2 NA	2CDS 253 103 R0277	53264 8		0.500	1
	3	S 203-K 3 NA	2CDS 253 103 R0317	53265 5		0.500	1
	4	S 203-K 4 NA	2CDS 253 103 R0337	53266 2		0.500	1
	6	S 203-K 6 NA	2CDS 253 103 R0377	53267 9		0.500	1
	8	S 203-K 8 NA	2CDS 253 103 R0407	53268 6		0.500	1
	10	S 203-K 10 NA	2CDS 253 103 R0427	53269 3		0.500	1
	13	S 203-K 13 NA	2CDS 253 103 R0447	53270 0		0.500	1
	16	S 203-K 16 NA	2CDS 253 103 R0467	53271 6		0.500	1
	20	S 203-K 20 NA	2CDS 253 103 R0487	53272 3		0.500	1
	25	S 203-K 25 NA	2CDS 253 103 R0517	53273 0		0.500	1
	32	S 203-K 32 NA	2CDS 253 103 R0537	53274 7		0.500	1
	40	S 203-K 40 NA	2CDS 253 103 R0557	53275 4		0.500	1
	U_{Bmax} 440 V ~	50	S 203-K 50 NA	2CDS 253 103 R0577	55120 5		0.500
63		S 203-K 63 NA	2CDS 253 103 R0607	55121 2		0.500	1

6000

Z

2



S 200 Z characteristic

Function: protection and control of the electronic circuits against weak and long duration overloads and short-circuits.

Applications: commercial and industrial.

Standard: IEC/EN 60947-2, VDE 0660 Part 101

I_{cu}=6 kA (acc. to VDE 0660 Part 101)

Number of poles	Rated current	Order details		Bbn 4016779	Price 1 piece	Price group	Weight 1 piece	Pack unit
		In A	Type code					
1	0.5	S 201-Z 0.5		2CDS 251 001 R0158	53030 9		0.125	10
	1	S 201-Z 1		2CDS 251 001 R0218	53033 0		0.125	10
	1.6	S 201-Z 1.6		2CDS 251 001 R0258	53034 7		0.125	10
	2	S 201-Z 2		2CDS 251 001 R0278	53035 4		0.125	10
	3	S 201-Z 3		2CDS 251 001 R0318	53036 1		0.125	10
	4	S 201-Z 4		2CDS 251 001 R0338	53037 8		0.125	10
	6	S 201-Z 6		2CDS 251 001 R0378	53040 8		0.125	10
	8	S 201-Z 8		2CDS 251 001 R0408	53041 5		0.125	10
	10	S 201-Z 10		2CDS 251 001 R0428	53042 2		0.125	10
	16	S 201-Z 16		2CDS 251 001 R0468	53043 9		0.125	10
	20	S 201-Z 20		2CDS 251 001 R0488	53044 6		0.125	10
	25	S 201-Z 25		2CDS 251 001 R0518	53045 3		0.125	10
	32	S 201-Z 32		2CDS 251 001 R0538	53046 0		0.125	10
	40	S 201-Z 40		2CDS 251 001 R0558	53047 7		0.125	10
	50	S 201-Z 50		2CDS 251 001 R0578	55191 5		0.125	10
63	S 201-Z 63		2CDS 251 001 R0608	55192 2		0.125	10	
2	0.5	S 202-Z 0.5		2CDS 252 001 R0158	53068 2		0.250	5
	1	S 202-Z 1		2CDS 252 001 R0218	53067 5		0.250	5
	1.6	S 202-Z 1.6		2CDS 252 001 R0258	53069 9		0.250	5
	2	S 202-Z 2		2CDS 252 001 R0278	53070 5		0.250	5
	3	S 202-Z 3		2CDS 252 001 R0318	53071 2		0.250	5
	4	S 202-Z 4		2CDS 252 001 R0338	53072 9		0.250	5
	6	S 202-Z 6		2CDS 252 001 R0378	53073 6		0.250	5
	8	S 202-Z 8		2CDS 252 001 R0408	53074 3		0.250	5
	10	S 202-Z 10		2CDS 252 001 R0428	53075 0		0.250	5
	16	S 202-Z 16		2CDS 252 001 R0468	53076 7		0.250	5
	20	S 202-Z 20		2CDS 252 001 R0488	53077 4		0.250	5
	25	S 202-Z 25		2CDS 252 001 R0518	53078 1		0.250	5
	32	S 202-Z 32		2CDS 252 001 R0538	53079 8		0.250	5
	40	S 202-Z 40		2CDS 252 001 R0558	53080 4		0.250	5
	50	S 202-Z 50		2CDS 252 001 R0578	55193 9		0.250	5
63	S 202-Z 63		2CDS 252 001 R0608	55194 6		0.250	5	
3	0.5	S 203-Z 0.5		2CDS 253 001 R0158	53097 2		0.375	1
	1	S 203-Z 1		2CDS 253 001 R0218	53098 9		0.375	1
	1.6	S 203-Z 1.6		2CDS 253 001 R0258	53099 6		0.375	1
	2	S 203-Z 2		2CDS 253 001 R0278	53100 9		0.375	1
	3	S 203-Z 3		2CDS 253 001 R0318	53101 6		0.375	1
	4	S 203-Z 4		2CDS 253 001 R0338	53102 3		0.375	1
	6	S 203-Z 6		2CDS 253 001 R0378	53103 0		0.375	1
	8	S 203-Z 8		2CDS 253 001 R0408	53104 7		0.375	1
	10	S 203-Z 10		2CDS 253 001 R0428	53105 4		0.375	1
	16	S 203-Z 16		2CDS 253 001 R0468	53106 1		0.375	1
	20	S 203-Z 20		2CDS 253 001 R0488	53107 8		0.375	1
	25	S 203-Z 25		2CDS 253 001 R0518	53108 5		0.375	1
	32	S 203-Z 32		2CDS 253 001 R0538	53109 2		0.375	1
	40	S 203-Z 40		2CDS 253 001 R0558	53110 8		0.375	1
	50	S 203-Z 50		2CDS 253 001 R0578	55195 3		0.375	1
63	S 203-Z 63		2CDS 253 001 R0608	55196 0		0.375	1	

U_{Bmax}
253 V ~
72 V ...

U_{Bmax}
440 V ~
125 V ...

①

U_{Bmax}
440 V ~

6000

2

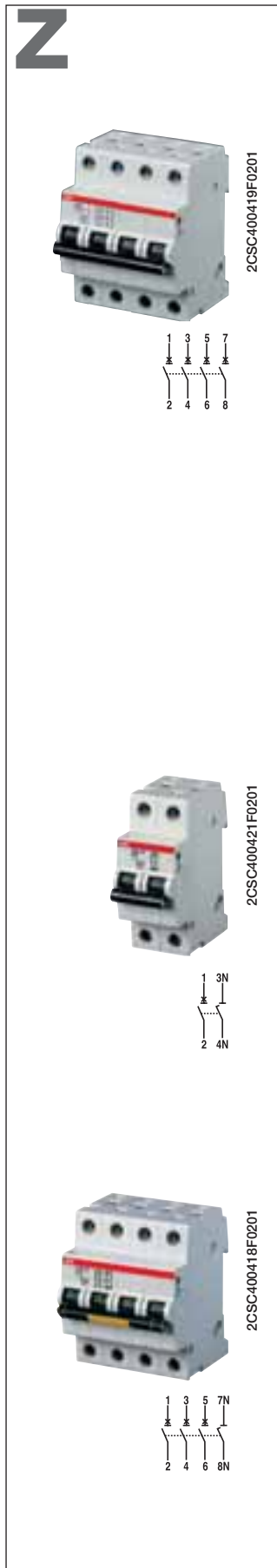

4	0.5	S 204-Z 0.5	2CDS 254 001 R0158	53024 8	0.500	1
	1	S 204-Z 1	2CDS 254 001 R0218	53132 0	0.500	1
	1.6	S 204-Z 1.6	2CDS 254 001 R0258	53144 3	0.500	1
	2	S 204-Z 2	2CDS 254 001 R0278	53143 6	0.500	1
	3	S 204-Z 3	2CDS 254 001 R0318	53133 7	0.500	1
	4	S 204-Z 4	2CDS 254 001 R0338	53134 4	0.500	1
	6	S 204-Z 6	2CDS 254 001 R0378	53135 1	0.500	1
	8	S 204-Z 8	2CDS 254 001 R0408	53136 8	0.500	1
	10	S 204-Z 10	2CDS 254 001 R0428	53137 5	0.500	1
	16	S 204-Z 16	2CDS 254 001 R0468	53138 2	0.500	1
	20	S 204-Z 20	2CDS 254 001 R0488	53139 9	0.500	1
	25	S 204-Z 25	2CDS 254 001 R0518	53140 5	0.500	1
	32	S 204-Z 32	2CDS 254 001 R0538	53141 2	0.500	1
	40	S 204-Z 40	2CDS 254 001 R0558	53142 9	0.500	1
50	S 204-Z 50	2CDS 254 001 R0578	55197 7	0.500	1	
63	S 204-Z 63	2CDS 254 001 R0608	55198 4	0.500	1	

U_{Bmax}
440 V ~
125 V ...

① U_{Bmax} 125 V ... with 2 poles connected in series

With disconnecting neutral NA

Number of poles	Rated current	Order details		Bbn 4016779	Price 1 piece	Price group	Weight 1 piece	Pack unit
		In A	Type code					
1 + NA	0.5	S 201-Z 0.5 NA	2CDS 251 103 R0158	53214 3	0.260	5		
	1	S 201-Z 1 NA	2CDS 251 103 R0218	53215 0	0.260	5		
	1.6	S 201-Z 1.6 NA	2CDS 251 103 R0258	53216 7	0.260	5		
	2	S 201-Z 2 NA	2CDS 251 103 R0278	53217 4	0.260	5		
	3	S 201-Z 3 NA	2CDS 251 103 R0318	53218 1	0.260	5		
	4	S 201-Z 4 NA	2CDS 251 103 R0338	53219 8	0.260	5		
	6	S 201-Z 6 NA	2CDS 251 103 R0378	53220 4	0.260	5		
	8	S 201-Z 8 NA	2CDS 251 103 R0408	53221 1	0.260	5		
	10	S 201-Z 10 NA	2CDS 251 103 R0428	53222 8	0.260	5		
	16	S 201-Z 16 NA	2CDS 251 103 R0468	53223 5	0.260	5		
	20	S 201-Z 20 NA	2CDS 251 103 R0488	53224 2	0.260	5		
	25	S 201-Z 25 NA	2CDS 251 103 R0518	53225 9	0.260	5		
	32	S 201-Z 32 NA	2CDS 251 103 R0538	53226 6	0.260	5		
	40	S 201-Z 40 NA	2CDS 251 103 R0558	53227 3	0.260	5		
50	S 201-Z 50 NA	2CDS 251 103 R0578	55212 7	0.320	5			
63	S 201-Z 63 NA	2CDS 251 103 R0608	55213 4	0.320	5			
3 + NA	0.5	S 203-Z 0.5 NA	2CDS 253 103 R0158	53292 1	0.520	1		
	1	S 203-Z 1 NA	2CDS 253 103 R0218	53293 8	0.520	1		
	1.6	S 203-Z 1.6 NA	2CDS 253 103 R0258	53294 5	0.520	1		
	2	S 203-Z 2 NA	2CDS 253 103 R0278	53295 2	0.520	1		
	3	S 203-Z 3 NA	2CDS 253 103 R0318	53297 6	0.520	1		
	4	S 203-Z 4 NA	2CDS 253 103 R0338	53298 3	0.520	1		
	6	S 203-Z 6 NA	2CDS 253 103 R0378	53299 0	0.520	1		
	8	S 203-Z 8 NA	2CDS 253 103 R0408	53300 3	0.520	1		
	10	S 203-Z 10 NA	2CDS 253 103 R0428	53301 0	0.520	1		
	16	S 203-Z 16 NA	2CDS 253 103 R0468	53302 7	0.520	1		
	20	S 203-Z 20 NA	2CDS 253 103 R0488	53305 8	0.520	1		
	25	S 203-Z 25 NA	2CDS 253 103 R0518	53306 5	0.520	1		
	32	S 203-Z 32 NA	2CDS 253 103 R0538	53307 2	0.520	1		
	40	S 203-Z 40 NA	2CDS 253 103 R0558	53308 9	0.520	1		
50	S 203-Z 50 NA	2CDS 253 103 R0578	55214 1	0.640	1			
63	S 203-Z 63 NA	2CDS 253 103 R0608	55216 5	0.640	1			

U_{Bmax}
253 V ~
72 V ...

U_{Bmax}
440 V ~

B

2



2CSC400411F0201



2CSC400413F0201



2CSC400415F0201



2CSC400443F0201

S 200 M-B characteristic

Function: protection and control of the circuits against overloads and short-circuits; protection for people and big length cables in TN and IT systems.

Applications: residential, commercial and industrial.

Standard: IEC/EN 60898, IEC/EN 60947-2

I_{cn}=10 kA

Number of poles	Rated current In A	Order details Type code	Order code	Bbn	Price 1 piece	Price group	Weight 1 piece kg	Pack unit pc.
				4016779				
1	6	S 201 M-B 6	2CDS 271 001 R0065	54942 4			0.125	10
	10	S 201 M-B 10	2CDS 271 001 R0105	54943 1			0.125	10
	13	S 201 M-B 13	2CDS 271 001 R0135	54944 8			0.125	10
	16	S 201 M-B 16	2CDS 271 001 R0165	54945 5			0.125	10
	20 ①	S 201 M-B 20	2CDS 271 001 R0205	54946 2			0.125	10
	25	S 201 M-B 25	2CDS 271 001 R0255	54947 9			0.125	10
	32 ②	S 201 M-B 32	2CDS 271 001 R0325	54948 6			0.125	10
	40 ③	S 201 M-B 40	2CDS 271 001 R0405	54949 3			0.125	10
	50	S 201 M-B 50	2CDS 271 001 R0505	54381 1			0.125	10
	63	S 201 M-B 63	2CDS 271 001 R0635	54382 8			0.125	10
				U_{Bmax} 253 V ~				
				72 V ...				
2	6	S 202 M-B 6	2CDS 272 001 R0065	54958 5			0.250	5
	10	S 202 M-B 10	2CDS 272 001 R0105	54959 2			0.250	5
	13	S 202 M-B 13	2CDS 272 001 R0135	54960 8			0.250	5
	16	S 202 M-B 16	2CDS 272 001 R0165	54961 5			0.250	5
	20	S 202 M-B 20	2CDS 272 001 R0205	54962 2			0.250	5
	25	S 202 M-B 25	2CDS 272 001 R0255	54963 9			0.250	5
	32	S 202 M-B 32	2CDS 272 001 R0325	54964 6			0.250	5
	40	S 202 M-B 40	2CDS 272 001 R0405	54965 3			0.250	5
	50	S 202 M-B 50	2CDS 272 001 R0505	54385 9			0.250	5
	63	S 202 M-B 63	2CDS 272 001 R0635	54386 6			0.250	5
				U_{Bmax} 440 V ~				
				125 V ...				
				④				
3	6	S 203 M-B 6	2CDS 273 001 R0065	54966 0			0.375	1
	10	S 203 M-B 10	2CDS 273 001 R0105	54967 7			0.375	1
	13	S 203 M-B 13	2CDS 273 001 R0135	54968 4			0.375	1
	16	S 203 M-B 16	2CDS 273 001 R0165	54969 1			0.375	1
	20 ①	S 203 M-B 20	2CDS 273 001 R0205	54970 7			0.375	1
	25	S 203 M-B 25	2CDS 273 001 R0255	54971 4			0.375	1
	32 ②	S 203 M-B 32	2CDS 273 001 R0325	54972 1			0.375	1
	40 ③	S 203 M-B 40	2CDS 273 001 R0405	54973 8			0.375	1
	50	S 203 M-B 50	2CDS 273 001 R0505	54387 3			0.375	1
	63	S 203 M-B 63	2CDS 273 001 R0635	54388 0			0.375	1
				U_{Bmax} 440 V ~				
4	6	S 204 M-B 6	2CDS 274 001 R0065	54982 0			0.500	1
	10	S 204 M-B 10	2CDS 274 001 R0105	54983 7			0.500	1
	13	S 204 M-B 13	2CDS 274 001 R0135	54984 4			0.500	1
	16	S 204 M-B 16	2CDS 274 001 R0165	54985 1			0.500	1
	20	S 204 M-B 20	2CDS 274 001 R0205	54986 8			0.500	1
	25	S 204 M-B 25	2CDS 274 001 R0255	54987 5			0.500	1
	32	S 204 M-B 32	2CDS 274 001 R0325	54988 2			0.500	1
	40	S 204 M-B 40	2CDS 274 001 R0405	54989 9			0.500	1
	50	S 204 M-B 50	2CDS 274 001 R0505	54391 0			0.500	1
	63	S 204 M-B 63	2CDS 274 001 R0635	54392 7			0.500	1
				U_{Bmax} 440 V ~				
				125 V ...				
				④				

① suitable for flow-type heaters 12 kW

② suitable for flow-type heaters 18 kW

③ suitable for flow-type heaters 21, 24 and 27 kW

④ U_{Bmax} 125 V ... with 2 poles connected in series

10000

B



2CSC400421 F0201



2CSC400418 F0201



With disconnecting neutral NA

Number of poles	Rated current In A	Order details Type code	Order code	Bbn 4016779	Price 1 piece	Price group	Weight 1 piece kg	Pack unit pc.	
1 +	6	S 201 M-B 6 NA	2CDS 271 103 R0065	54950 9			0.250	5	
	10	S 201 M-B 10 NA	2CDS 271 103 R0105	54951 6			0.250	5	
	NA	13	S 201 M-B 13 NA	2CDS 271 103 R0135	54952 3			0.250	5
		16	S 201 M-B 16 NA	2CDS 271 103 R0165	54953 0			0.250	5
		20 ①	S 201 M-B 20 NA	2CDS 271 103 R0205	54954 7			0.250	5
		25	S 201 M-B 25 NA	2CDS 271 103 R0255	54955 4			0.250	5
		32 ②	S 201 M-B 32 NA	2CDS 271 103 R0325	54956 1			0.250	5
		40 ③	S 201 M-B 40 NA	2CDS 271 103 R0405	54957 8			0.250	5
		50	S 201 M-B 50 NA	2CDS 271 103 R0505	54383 5			0.250	5
		63	S 201 M-B 63 NA	2CDS 271 103 R0635	54384 2			0.250	5
3 +	6	S 203 M-B 6 NA	2CDS 273 103 R0065	54974 5			0.500	1	
	10	S 203 M-B 10 NA	2CDS 273 103 R0105	54975 2			0.500	1	
	NA	13	S 203 M-B 13 NA	2CDS 273 103 R0135	54976 9			0.500	1
		16	S 203 M-B 16 NA	2CDS 273 103 R0165	54977 6			0.500	1
		20 ①	S 203 M-B 20 NA	2CDS 273 103 R0205	54978 3			0.500	1
		25	S 203 M-B 25 NA	2CDS 273 103 R0255	54979 0			0.500	1
		32 ②	S 203 M-B 32 NA	2CDS 273 103 R0325	54980 6			0.500	1
		40 ③	S 203 M-B 40 NA	2CDS 273 103 R0405	54981 3			0.500	1
		50	S 203 M-B 50 NA	2CDS 273 103 R0505	54389 7			0.500	1
		63	S 203 M-B 63 NA	2CDS 273 103 R0635	54390 3			0.580	1

- ① suitable for flow-type heaters 12 kW
- ② suitable for flow-type heaters 18 kW

- ③ suitable for flow-type heaters 21, 24 and 27 kW

2

10000

C



2CSC400424F0201



2CSC400425F0201



2CSC400426F0201



S 200 M-C characteristic

Function: protection and control of the circuits against overloads and short-circuits; protection for resistive and inductive loads with low inrush current.

Applications: residential, commercial and industrial.

Standard: IEC/EN 60898, IEC/EN 60947-2

I_{cn}=10 kA

Number of poles	Rated current	Order details	Bbn 4016779	Price 1 piece	Price group	Weight 1 piece	Pack unit
In A	Type code	Order code	EAN			kg	pc.
1	0.5	S 201 M-C 0.5	2CDS 271 001 R0984	54990 5		0.125	10
	1	S 201 M-C 1	2CDS 271 001 R0014	54992 9		0.125	10
	1.6	S 201 M-C 1.6	2CDS 271 001 R0974	54991 2		0.125	10
	2	S 201 M-C 2	2CDS 271 001 R0024	54993 6		0.125	10
	3	S 201 M-C 3	2CDS 271 001 R0034	54994 3		0.125	10
	4	S 201 M-C 4	2CDS 271 001 R0044	54995 0		0.125	10
	6	S 201 M-C 6	2CDS 271 001 R0064	54996 7		0.125	10
	8	S 201 M-C 8	2CDS 271 001 R0084	54997 4		0.125	10
	10	S 201 M-C 10	2CDS 271 001 R0104	54998 1		0.125	10
	13	S 201 M-C 13	2CDS 271 001 R0134	54999 8		0.125	10
	16	S 201 M-C 16	2CDS 271 001 R0164	55000 0		0.125	10
	20 ①	S 201 M-C 20	2CDS 271 001 R0204	55001 7		0.125	10
	25	S 201 M-C 25	2CDS 271 001 R0254	55002 4		0.125	10
	32 ②	S 201 M-C 32	2CDS 271 001 R0324	55003 1		0.125	10
	40 ③	S 201 M-C 40	2CDS 271 001 R0404	55004 8		0.125	10
	50	S 201 M-C 50	2CDS 271 001 R0504	54393 4		0.125	10
	63	S 201 M-C 63	2CDS 271 001 R0634	54394 1		0.125	10
U_{Bmax} 253 V ~ 72 V ...							
2	0.5	S 202 M-C 0.5	2CDS 272 001 R0984	55020 8		0.250	5
	1	S 202 M-C 1	2CDS 272 001 R0014	55022 2		0.250	5
	1.6	S 202 M-C 1.6	2CDS 272 001 R0974	55021 5		0.250	5
	2	S 202 M-C 2	2CDS 272 001 R0024	55023 9		0.250	5
	3	S 202 M-C 3	2CDS 272 001 R0034	55024 6		0.250	5
	4	S 202 M-C 4	2CDS 272 001 R0044	55025 3		0.250	5
	6	S 202 M-C 6	2CDS 272 001 R0064	55026 0		0.250	5
	8	S 202 M-C 8	2CDS 272 001 R0084	55027 7		0.250	5
	10	S 202 M-C 10	2CDS 272 001 R0104	55028 4		0.250	5
	13	S 202 M-C 13	2CDS 272 001 R0134	55029 1		0.250	5
	16	S 202 M-C 16	2CDS 272 001 R0164	55030 7		0.250	5
	20	S 202 M-C 20	2CDS 272 001 R0204	55031 4		0.250	5
	25	S 202 M-C 25	2CDS 272 001 R0254	55032 1		0.250	5
	32	S 202 M-C 32	2CDS 272 001 R0324	55033 8		0.250	5
	40	S 202 M-C 40	2CDS 272 001 R0404	55034 5		0.250	5
	50	S 202 M-C 50	2CDS 272 001 R0504	54397 2		0.250	5
	63	S 202 M-C 63	2CDS 272 001 R0634	54398 9		0.250	5
U_{Bmax} 440 V ~ 125 V ...							
3	0.5	S 203 M-C 0.5	2CDS 273 001 R0984	55035 2		0.375	1
	1	S 203 M-C 1	2CDS 273 001 R0014	55037 6		0.375	1
	1.6	S 203 M-C 1.6	2CDS 273 001 R0974	55036 9		0.375	1
	2	S 203 M-C 2	2CDS 273 001 R0024	55038 3		0.375	1
	3	S 203 M-C 3	2CDS 273 001 R0034	55039 0		0.375	1
	4	S 203 M-C 4	2CDS 273 001 R0044	55040 6		0.375	1
	6	S 203 M-C 6	2CDS 273 001 R0064	55041 3		0.375	1
	8	S 203 M-C 8	2CDS 273 001 R0084	55042 0		0.375	1
	10	S 203 M-C 10	2CDS 273 001 R0104	55043 7		0.375	1
	13	S 203 M-C 13	2CDS 273 001 R0134	55044 4		0.375	1
	16	S 203 M-C 16	2CDS 273 001 R0164	55045 1		0.375	1
	20 ①	S 203 M-C 20	2CDS 273 001 R0204	55046 8		0.375	1
	25	S 203 M-C 25	2CDS 273 001 R0254	55047 5		0.375	1
	32 ②	S 203 M-C 32	2CDS 273 001 R0324	55048 2		0.375	1
	40 ③	S 203 M-C 40	2CDS 273 001 R0404	55049 9		0.375	1
	50	S 203 M-C 50	2CDS 273 001 R0504	54399 6		0.375	1
	63	S 203 M-C 63	2CDS 273 001 R0634	54400 9		0.375	1
U_{Bmax} 440 V ~							

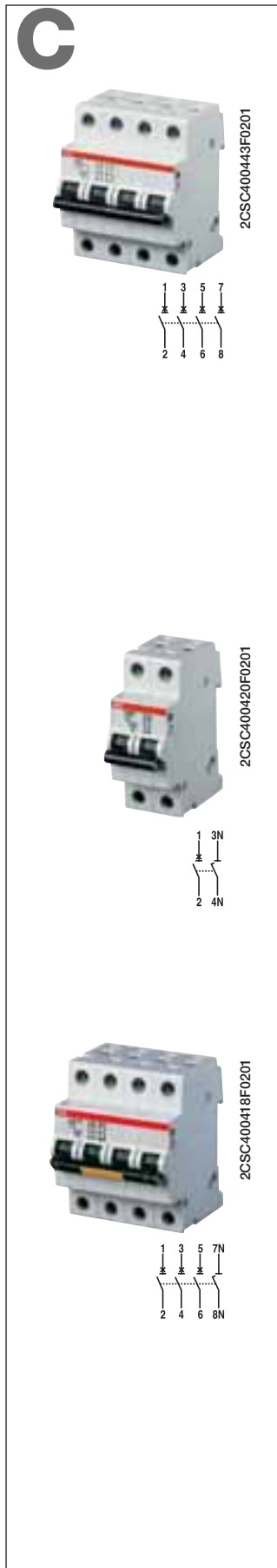

4	0.5	S 204 M-C 0.5	2CDS 274 001 R0984	55065 9	0.500	1
	1	S 204 M-C 1	2CDS 274 001 R0014	55067 3	0.500	1
	1.6	S 204 M-C 1.6	2CDS 274 001 R0974	55066 6	0.500	1
	2	S 204 M-C 2	2CDS 274 001 R0024	55068 0	0.500	1
	3	S 204 M-C 3	2CDS 274 001 R0034	55069 7	0.500	1
	4	S 204 M-C 4	2CDS 274 001 R0044	55070 3	0.500	1
	6	S 204 M-C 6	2CDS 274 001 R0064	55071 0	0.500	1
	8	S 204 M-C 8	2CDS 274 001 R0084	55072 7	0.500	1
	10	S 204 M-C 10	2CDS 274 001 R0104	55073 4	0.500	1
	13	S 204 M-C 13	2CDS 274 001 R0134	55074 1	0.500	1
	16	S 204 M-C 16	2CDS 274 001 R0164	55075 8	0.500	1
	20	S 204 M-C 20	2CDS 274 001 R0204	55076 5	0.500	1
	25	S 204 M-C 25	2CDS 274 001 R0254	55077 2	0.500	1
	32	S 204 M-C 32	2CDS 274 001 R0324	55078 9	0.500	1
	40	S 204 M-C 40	2CDS 274 001 R0404	55079 6	0.500	1
	50	S 204 M-C 50	2CDS 274 001 R0504	54403 0	0.500	1
④	63	S 204 M-C 63	2CDS 274 001 R0634	54404 7	0.500	1

U_{Bmax}
440 V ~
125 V ...

- ① suitable for flow-type heaters 12 kW
- ② suitable for flow-type heaters 18 kW
- ③ suitable for flow-type heaters 21, 24 and 27 kW
- ④ U_{Bmax} 125 V ... with 2 poles connected in series

With disconnecting neutral NA

Number of poles	Rated current	Order details	Bbn 4016779	Price 1 piece	Price group	Weight 1 piece	Pack unit
In A	Type code	Order code	EAN	kg	pc.		
1	0.5	S 201 M-C 0.5 NA	2CDS 271 103 R0984	55005 5	0.250	5	
+	1	S 201 M-C 1 NA	2CDS 271 103 R0014	55007 9	0.250	5	
NA	1.6	S 201 M-C 1.6 NA	2CDS 271 103 R0974	55006 2	0.250	5	
	2	S 201 M-C 2 NA	2CDS 271 103 R0024	55008 6	0.250	5	
	3	S 201 M-C 3 NA	2CDS 271 103 R0034	55009 3	0.250	5	
	4	S 201 M-C 4 NA	2CDS 271 103 R0044	55010 9	0.250	5	
	6	S 201 M-C 6 NA	2CDS 271 103 R0064	55011 6	0.250	5	
	8	S 201 M-C 8 NA	2CDS 271 103 R0084	55012 3	0.250	5	
	10	S 201 M-C 10 NA	2CDS 271 103 R0104	55013 0	0.250	5	
	13	S 201 M-C 13 NA	2CDS 271 103 R0134	55014 7	0.250	5	
	16	S 201 M-C 16 NA	2CDS 271 103 R0164	55015 4	0.250	5	
	20 ①	S 201 M-C 20 NA	2CDS 271 103 R0204	55016 1	0.250	5	
	25	S 201 M-C 25 NA	2CDS 271 103 R0254	55017 8	0.250	5	
	32 ②	S 201 M-C 32 NA	2CDS 271 103 R0324	55018 5	0.250	5	
	40 ③	S 201 M-C 40 NA	2CDS 271 103 R0404	55019 2	0.250	5	
	50	S 201 M-C 50 NA	2CDS 271 103 R0504	54395 8	0.250	5	
	63	S 201 M-C 63 NA	2CDS 271 103 R0634	54396 5	0.250	5	

U_{Bmax}
253 V ~
72 V ...

3	0.5	S 203 M-C 0.5 NA	2CDS 273 103 R0984	55051 2	0.500	1
+	1	S 203 M-C 1 NA	2CDS 273 103 R0014	55052 9	0.500	1
NA	1.6	S 203 M-C 1.6 NA	2CDS 273 103 R0974	55050 5	0.500	1
	2	S 203 M-C 2 NA	2CDS 273 103 R0024	55053 6	0.500	1
	3	S 203 M-C 3 NA	2CDS 273 103 R0034	55054 3	0.500	1
	4	S 203 M-C 4 NA	2CDS 273 103 R0044	55055 0	0.500	1
	6	S 203 M-C 6 NA	2CDS 273 103 R0064	55056 7	0.500	1
	8	S 203 M-C 8 NA	2CDS 273 103 R0084	55057 4	0.500	1
	10	S 203 M-C 10 NA	2CDS 273 103 R0104	55058 1	0.500	1
	13	S 203 M-C 13 NA	2CDS 273 103 R0134	55059 8	0.500	1
	16	S 203 M-C 16 NA	2CDS 273 103 R0164	55060 4	0.500	1
	20 ①	S 203 M-C 20 NA	2CDS 273 103 R0204	55061 1	0.500	1
	25	S 203 M-C 25 NA	2CDS 273 103 R0254	55062 8	0.500	1
	32 ②	S 203 M-C 32 NA	2CDS 273 103 R0324	55063 5	0.500	1
	40 ③	S 203 M-C 40 NA	2CDS 273 103 R0404	55064 2	0.500	1
	50	S 203 M-C 50 NA	2CDS 273 103 R0504	54401 6	0.580	1
	63	S 203 M-C 63 NA	2CDS 273 103 R0634	54402 3	0.580	1

U_{Bmax}
440 V ~

- ① suitable for flow-type heaters 12 kW
- ② suitable for flow-type heaters 18 kW
- ③ suitable for flow-type heaters 21, 24 and 27 kW

10000

D



S 200 M-D characteristic

Function: protection and control of the circuits against overloads and short-circuits; protection for circuits which supply loads with high inrush current at the circuit closing (LV/LV transformers, break-down lamps).

Applications: residential, commercial and industrial.

Standard: IEC/EN 60898, IEC/EN 60947-2

Icn=10 kA

Number of poles	Rated current	Order details	Bbn 4016779	Price 1 piece	Price group	Weight 1 piece	Pack unit
In A	Type code	Order code	EAN			kg	pc.
1	0.5	S 201 M-D 0.5	2CDS 271 001 R0981	59983 2		0.125	10
	1	S 201 M-D 1	2CDS 271 001 R0011	50031 3		0.125	10
	1.6	S 201 M-D 1.6	2CDS 271 001 R0971	59982 5		0.125	10
	2	S 201 M-D 2	2CDS 271 001 R0021	59933 7		0.125	10
	3	S 201 M-D 3	2CDS 271 001 R0031	59935 1		0.125	10
	4	S 201 M-D 4	2CDS 271 001 R0041	59935 7		0.125	10
	6	S 201 M-D 6	2CDS 271 001 R0061	59939 9		0.125	10
	8	S 201 M-D 8	2CDS 271 001 R0081	59940 5		0.125	10
	10	S 201 M-D 10	2CDS 271 001 R0101	59942 9		0.125	10
	13	S 201 M-D 13	2CDS 271 001 R0131	66326 7		0.125	10
	16	S 201 M-D 16	2CDS 271 001 R0161	59945 0		0.125	10
	20 ①	S 201 M-D 20	2CDS 271 001 R0201	50046 7		0.125	10
	25	S 201 M-D 25	2CDS 271 001 R0251	59949 8		0.125	10
	32 ②	S 201 M-D 32	2CDS 271 001 R0321	59956 6		0.125	10
	40 ③	S 201 M-D 40	2CDS 271 001 R0401	59961 0		0.125	10
	50	S 201 M-D 50	2CDS 271 001 R0501	59970 2		0.125	10
63	S 201 M-D 63	2CDS 271 001 R0631	59981 8		0.125	10	
U_{Bmax} 253 V ~ 72 V ...							
2	0.5	S 202 M-D 0.5	2CDS 272 001 R0981	60088 0		0.250	5
	1	S 202 M-D 1	2CDS 272 001 R0011	60036 1		0.250	5
	1.6	S 202 M-D 1.6	2CDS 272 001 R0971	60087 3		0.250	5
	2	S 202 M-D 2	2CDS 272 001 R0021	60038 5		0.250	5
	3	S 202 M-D 3	2CDS 272 001 R0031	60040 8		0.250	5
	4	S 202 M-D 4	2CDS 272 001 R0041	60042 2		0.250	5
	6	S 202 M-D 6	2CDS 272 001 R0061	60044 6		0.250	5
	8	S 202 M-D 8	2CDS 272 001 R0081	60045 3		0.250	5
	10	S 202 M-D 10	2CDS 272 001 R0101	60047 7		0.250	5
	13	S 202 M-D 13	2CDS 272 001 R0131	66327 4		0.250	5
	16	S 202 M-D 16	2CDS 272 001 R0161	60050 7		0.250	5
	20	S 202 M-D 20	2CDS 272 001 R0201	60051 4		0.250	5
	25	S 202 M-D 25	2CDS 272 001 R0251	60054 5		0.250	5
	32	S 202 M-D 32	2CDS 272 001 R0321	60061 3		0.250	5
	40	S 202 M-D 40	2CDS 272 001 R0401	60066 8		0.250	5
	50	S 202 M-D 50	2CDS 272 001 R0501	60075 0		0.250	5
63 ④	S 202 M-D 63	2CDS 272 001 R0631	60086 6		0.250	5	
U_{Bmax} 440 V ~ 125 V ...							
3	0.5	S 203 M-D 0.5	2CDS 273 001 R0981	60141 2		0.375	1
	1	S 203 M-D 1	2CDS 273 001 R0011	60089 7		0.375	1
	1.6	S 203 M-D 1.6	2CDS 273 001 R0971	60140 5		0.375	1
	2	S 203 M-D 2	2CDS 273 001 R0021	60091 0		0.375	1
	3	S 203 M-D 3	2CDS 273 001 R0031	60093 4		0.375	1
	4	S 203 M-D 4	2CDS 273 001 R0041	60095 8		0.375	1
	6	S 203 M-D 6	2CDS 273 001 R0061	60097 2		0.375	1
	8	S 203 M-D 8	2CDS 273 001 R0081	60098 9		0.375	1
	10	S 203 M-D 10	2CDS 273 001 R0101	60100 9		0.375	1
	13	S 203 M-D 13	2CDS 273 001 R0131	66328 1		0.375	1
	16	S 203 M-D 16	2CDS 273 001 R0161	60103 0		0.375	1
	20 ①	S 203 M-D 20	2CDS 273 001 R0201	60104 7		0.375	1
	25	S 203 M-D 25	2CDS 273 001 R0251	60107 8		0.375	1
	32 ②	S 203 M-D 32	2CDS 273 001 R0321	60114 6		0.375	1
	40 ③	S 203 M-D 40	2CDS 273 001 R0401	60119 1		0.375	1
	50	S 203 M-D 50	2CDS 273 001 R0501	60128 3		0.375	1
63	S 203 M-D 63	2CDS 273 001 R0631	60139 9		0.375	1	
U_{Bmax} 440 V ~							

10000

2

D



4	0.5	S 204 M-D 0.5	2CDS 274 001 R0981	60214 3	0.500	1
	1	S 204 M-D 1	2CDS 274 001 R0011	60163 4	0.500	1
	1.6	S 204 M-D 1.6	2CDS 274 001 R0971	60213 6	0.500	1
	2	S 204 M-D 2	2CDS 274 001 R0021	60165 8	0.500	1
	3	S 204 M-D 3	2CDS 274 001 R0031	60167 2	0.500	1
	4	S 204 M-D 4	2CDS 274 001 R0041	60169 6	0.500	1
	6	S 204 M-D 6	2CDS 274 001 R0061	60171 9	0.500	1
	8	S 204 M-D 8	2CDS 274 001 R0081	60172 6	0.500	1
	10	S 204 M-D 10	2CDS 274 001 R0101	60174 0	0.500	1
	13	S 204 M-D 13	2CDS 274 001 R0131	66329 8	0.500	1
	16	S 204 M-D 16	2CDS 274 001 R0161	60177 1	0.500	1
	20	S 204 M-D 20	2CDS 274 001 R0201	60178 8	0.500	1
	25	S 204 M-D 25	2CDS 274 001 R0251	60181 8	0.500	1
	32	S 204 M-D 32	2CDS 274 001 R0321	60188 7	0.500	1
	40	S 204 M-D 40	2CDS 274 001 R0401	60193 1	0.500	1
	50	S 204 M-D 50	2CDS 274 001 R0501	60201 3	0.500	1
④	63	S 204 M-D 63	2CDS 274 001 R0631	60212 9	0.500	1

U_{Bmax}
440 V ~
125 V ...

- ① suitable for flow-type heaters 12 kW
- ② suitable for flow-type heaters 18 kW
- ③ suitable for flow-type heaters 21, 24 and 27 kW
- ④ U_{Bmax} 125 V ... with 2 poles connected in series

With disconnecting neutral NA



Number of poles	Rated current	Order details	Bbn 4016779	Price 1 piece	Price group	Weight 1 piece	Pack unit
	In A	Type code	Order code	EAN		kg	pc.
1	0.5	S 201 M-D 0.5 NA	2CDS 271 103 R0981	60035 4		0.250	5
+ NA	1	S 201 M-D 1 NA	2CDS 271 103 R0011	59984 9		0.250	5
	1.6	S 201 M-D 1.6 NA	2CDS 271 103 R0971	60034 7		0.250	5
	2	S 201 M-D 2 NA	2CDS 271 103 R0021	59986 3		0.250	5
	3	S 201 M-D 3 NA	2CDS 271 103 R0031	59988 7		0.250	5
	4	S 201 M-D 4 NA	2CDS 271 103 R0041	59990 0		0.250	5
	6	S 201 M-D 6 NA	2CDS 271 103 R0061	59992 4		0.250	5
	8	S 201 M-D 8 NA	2CDS 271 103 R0081	59993 1		0.250	5
	10	S 201 M-D 10 NA	2CDS 271 103 R0101	59994 8		0.250	5
	13	S 201 M-D 13 NA	2CDS 271 103 R0131	66330 4		0.250	5
	16	S 201 M-D 16 NA	2CDS 271 103 R0161	59997 9		0.250	5
	20 ①	S 201 M-D 20 NA	2CDS 271 103 R0201	59998 6		0.250	5
	25	S 201 M-D 25 NA	2CDS 271 103 R0251	60001 9		0.250	5
	32 ②	S 201 M-D 32 NA	2CDS 271 103 R0321	60008 8		0.250	5
	40 ③	S 201 M-D 40 NA	2CDS 271 103 R0401	60013 2		0.250	5
	50	S 201 M-D 50 NA	2CDS 271 103 R0501	60022 4		0.290	5
	63	S 201 M-D 63 NA	2CDS 271 103 R0631	60033 0		0.290	5

U_{Bmax}
253 V ~
72 V ...

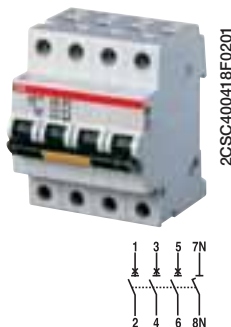

3	0.5	S 203 M-D 0.5 NA	2CDS 273 103 R0981	66331 1	0.500	1
+ NA	1	S 203 M-D 1 NA	2CDS 273 103 R0011	66332 8	0.500	1
	1.6	S 203 M-D 1.6 NA	2CDS 273 103 R0971	66333 5	0.500	1
	2	S 203 M-D 2 NA	2CDS 273 103 R0021	66334 2	0.500	1
	3	S 203 M-D 3 NA	2CDS 273 103 R0031	66335 9	0.500	1
	4	S 203 M-D 4 NA	2CDS 273 103 R0041	66336 6	0.500	1
	6	S 203 M-D 6 NA	2CDS 273 103 R0061	66337 3	0.500	1
	8	S 203 M-D 8 NA	2CDS 273 103 R0081	66338 0	0.500	1
	10	S 203 M-D 10 NA	2CDS 273 103 R0101	66339 7	0.500	1
	13	S 203 M-D 13 NA	2CDS 273 103 R0131	66340 3	0.500	1
	16	S 203 M-D 16 NA	2CDS 273 103 R0161	66341 0	0.500	1
	20 ①	S 203 M-D 20 NA	2CDS 273 103 R0201	66342 7	0.500	1
	25	S 203 M-D 25 NA	2CDS 273 103 R0251	66343 4	0.500	1
	32 ②	S 203 M-D 32 NA	2CDS 273 103 R0321	66344 1	0.500	1
	40 ③	S 203 M-D 40 NA	2CDS 273 103 R0401	66345 8	0.500	1
	50	S 203 M-D 50 NA	2CDS 273 103 R0501	66346 5	0.580	1
	63	S 203 M-D 63 NA	2CDS 273 103 R0631	66347 2	0.580	1

U_{Bmax}
440 V ~

- ① suitable for flow-type heaters 12 kW
- ② suitable for flow-type heaters 18 kW
- ③ suitable for flow-type heaters 21, 24 and 27 kW

10000

K



2CSC400424F0201



2CDC021171F0006



2CSC400426F0201



S 200 M-K (power) characteristic

Function: protection and control of the circuits like motors, transformer and auxiliary circuits, against overloads and short-circuits.

Advantages: no nuisance tripping in the case of functional peak currents up to 10xI_n, depending on the series; through its highly sensitive thermostatic bimetal trip, the K-type characteristic offers protection to damageable elements in the overcurrent range; it also provides the best protection to cables and lines.

Applications: commercial and industrial.

Standard: IEC/EN 60947-2, VDE 0660 Part 101

I_{cu}=10 kA (acc. to VDE 0660 Part 101)

Number of poles	Rated current	Order details	Bbn 4016779	Price 1 piece	Price group	Weight 1 piece	Pack unit
In A	Type code	Order code	EAN			kg	pc.
1	0.5	S 201 M-K 0.5	2CDS 271 001 R0157	59943 6		0.125	10
	1	S 201 M-K 1	2CDS 271 001 R0217	59947 4		0.125	10
	1.6	S 201 M-K 1.6	2CDS 271 001 R0257	59950 4		0.125	10
	2	S 201 M-K 2	2CDS 271 001 R0277	59952 8		0.125	10
	3	S 201 M-K 3	2CDS 271 001 R0317	59954 2		0.125	10
	4	S 201 M-K 4	2CDS 271 001 R0337	59957 3		0.125	10
	6	S 201 M-K 6	2CDS 271 001 R0377	59959 7		0.125	10
	8	S 201 M-K 8	2CDS 271 001 R0407	59962 7		0.125	10
	10	S 201 M-K 10	2CDS 271 001 R0427	59964 1		0.125	10
	13	S 201 M-K 13	2CDS 271 001 R0447	65939 0		0.125	10
	16	S 201 M-K 16	2CDS 271 001 R0467	59966 5		0.125	10
	20	S 201 M-K 20	2CDS 271 001 R0487	59968 9		0.125	10
	25	S 201 M-K 25	2CDS 271 001 R0517	59971 9		0.125	10
	32	S 201 M-K 32	2CDS 271 001 R0537	59973 3		0.125	10
	40	S 201 M-K 40	2CDS 271 001 R0557	59975 7		0.125	10
	50	S 201 M-K 50	2CDS 271 001 R0577	59977 1		0.125	10
	63	S 201 M-K 63	2CDS 271 001 R0607	59979 5		0.125	10
U _{Bmax} 253 V ~ 72 V ...							
2	0.5	S 202 M-K 0.5	2CDS 272 001 R0157	60048 4		0.250	5
	1	S 202 M-K 1	2CDS 272 001 R0217	60052 1		0.250	5
	1.6	S 202 M-K 1.6	2CDS 272 001 R0257	60055 2		0.250	5
	2	S 202 M-K 2	2CDS 272 001 R0277	60057 6		0.250	5
	3	S 202 M-K 3	2CDS 272 001 R0317	60059 0		0.250	5
	4	S 202 M-K 4	2CDS 272 001 R0337	60062 0		0.250	5
	6	S 202 M-K 6	2CDS 272 001 R0377	60064 4		0.250	5
	8	S 202 M-K 8	2CDS 272 001 R0407	60067 5		0.250	5
	10	S 202 M-K 10	2CDS 272 001 R0427	60069 9		0.250	5
	13	S 202 M-K 13	2CDS 272 001 R0447	65940 6		0.250	5
	16	S 202 M-K 16	2CDS 272 001 R0467	60071 2		0.250	5
	20	S 202 M-K 20	2CDS 272 001 R0487	60073 6		0.250	5
	25	S 202 M-K 25	2CDS 272 001 R0517	60076 7		0.250	5
	32	S 202 M-K 32	2CDS 272 001 R0537	60078 1		0.250	5
	40	S 202 M-K 40	2CDS 272 001 R0557	60080 4		0.250	5
	50	S 202 M-K 50	2CDS 272 001 R0577	60082 8		0.250	5
	63	S 202 M-K 63	2CDS 272 001 R0607	60084 2		0.250	5
U _{Bmax} 440 V ~ 125 V ...							
3	0.5	S 203 M-K 0.5	2CDS 273 001 R0157	60101 6		0.375	1
	1	S 203 M-K 1	2CDS 273 001 R0217	60105 4		0.375	1
	1.6	S 203 M-K 1.6	2CDS 273 001 R0257	60108 5		0.375	1
	2	S 203 M-K 2	2CDS 273 001 R0277	60110 8		0.375	1
	3	S 203 M-K 3	2CDS 273 001 R0317	60112 2		0.375	1
	4	S 203 M-K 4	2CDS 273 001 R0337	60115 3		0.375	1
	6	S 203 M-K 6	2CDS 273 001 R0377	60117 7		0.375	1
	8	S 203 M-K 8	2CDS 273 001 R0407	60120 7		0.375	1
	10	S 203 M-K 10	2CDS 273 001 R0427	60122 1		0.375	1
	13	S 203 M-K 13	2CDS 273 001 R0447	65941 3		0.375	1
	16	S 203 M-K 16	2CDS 273 001 R0467	60124 5		0.375	1
	20	S 203 M-K 20	2CDS 273 001 R0487	60126 9		0.375	1
	25	S 203 M-K 25	2CDS 273 001 R0517	60129 0		0.375	1
	32	S 203 M-K 32	2CDS 273 001 R0537	60131 3		0.375	1
	40	S 203 M-K 40	2CDS 273 001 R0557	60133 7		0.375	1
	50	S 203 M-K 50	2CDS 273 001 R0577	60135 1		0.375	1
	63	S 203 M-K 63	2CDS 273 001 R0607	60137 5		0.375	1
U _{Bmax} 440 V ~							

10000

2

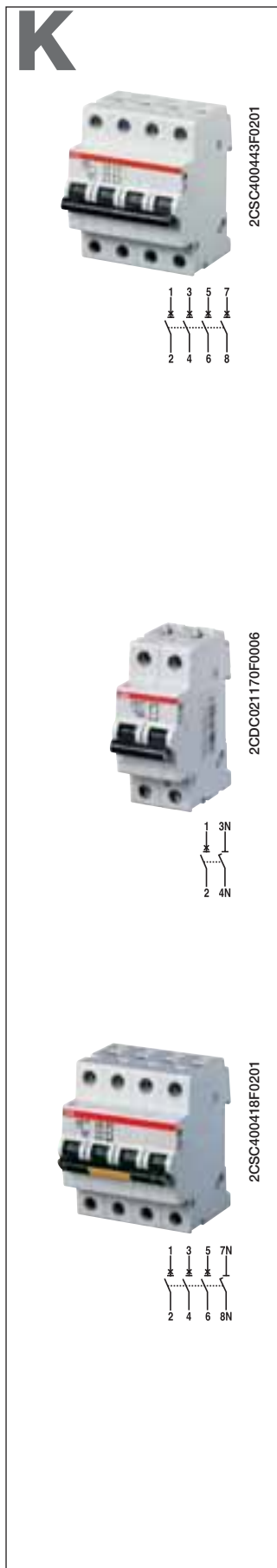

4	0.5	S 204 M-K 0.5	2CDS 274 001 R0157	60175 7	0.500	1
	1	S 204 M-K 1	2CDS 274 001 R0217	60179 5	0.500	1
	1.6	S 204 M-K 1.6	2CDS 274 001 R0257	60182 5	0.500	1
	2	S 204 M-K 2	2CDS 274 001 R0277	60184 9	0.500	1
	3	S 204 M-K 3	2CDS 274 001 R0317	60186 3	0.500	1
	4	S 204 M-K 4	2CDS 274 001 R0337	60189 4	0.500	1
	6	S 204 M-K 6	2CDS 274 001 R0377	60191 7	0.500	1
	8	S 204 M-K 8	2CDS 274 001 R0407	60194 8	0.500	1
	10	S 204 M-K 10	2CDS 274 001 R0427	60196 2	0.500	1
	13	S 204 M-K 13	2CDS 274 001 R0447	65942 0	0.500	1
	16	S 204 M-K 16	2CDS 274 001 R0467	60198 6	0.500	1
	20	S 204 M-K 20	2CDS 274 001 R0487	60200 6	0.500	1
	25	S 204 M-K 25	2CDS 274 001 R0517	60202 0	0.500	1
	32	S 204 M-K 32	2CDS 274 001 R0537	60204 4	0.500	1
40	S 204 M-K 40	2CDS 274 001 R0557	60206 8	0.500	1	
U_{Bmax} 440 V ~	50	S 204 M-K 50	2CDS 274 001 R0577	60208 2	0.500	1
	63	S 204 M-K 63	2CDS 274 001 R0607	60210 5	0.500	1
125 V ...	63	S 204 M-K 63	2CDS 274 001 R0607	60210 5	0.500	1

① U_{Bmax} 125 V ... with 2 poles connected in series

With disconnecting neutral NA

Number of poles	Rated current In A	Order details Type code	Order code	EAN	Price 1 piece	Price group	Weight 1 piece kg	Pack unit pc.	Bbn 4016779
1 + NA	0.5	S 201 M-K 0.5 NA	2CDS 271 103 R0157	59995 5			0.250	5	
	1	S 201 M-K 1 NA	2CDS 271 103 R0217	59999 3			0.250	5	
	1.6	S 201 M-K 1.6 NA	2CDS 271 103 R0257	60002 6			0.250	5	
	2	S 201 M-K 2 NA	2CDS 271 103 R0277	60004 0			0.250	5	
	3	S 201 M-K 3 NA	2CDS 271 103 R0317	60006 4			0.250	5	
	4	S 201 M-K 4 NA	2CDS 271 103 R0337	60009 5			0.250	5	
	6	S 201 M-K 6 NA	2CDS 271 103 R0377	60011 8			0.250	5	
	8	S 201 M-K 8 NA	2CDS 271 103 R0407	60014 9			0.250	5	
	10	S 201 M-K 10 NA	2CDS 271 103 R0427	60016 3			0.250	5	
	13	S 201 M-K 13 NA	2CDS 271 103 R0447	65943 7			0.250	5	
	16	S 201 M-K 16 NA	2CDS 271 103 R0467	60018 7			0.250	5	
	20	S 201 M-K 20 NA	2CDS 271 103 R0487	60020 0			0.250	5	
	25	S 201 M-K 25 NA	2CDS 271 103 R0517	60023 1			0.250	5	
	32	S 201 M-K 32 NA	2CDS 271 103 R0537	60025 5			0.250	5	
U_{Bmax} 253 V ~	40	S 201 M-K 40 NA	2CDS 271 103 R0557	60027 9			0.250	5	
	50	S 201 M-K 50 NA	2CDS 271 103 R0577	60029 3			0.250	5	
	63	S 201 M-K 63 NA	2CDS 271 103 R0607	60031 6			0.250	5	
	3 + NA	0.5	S 203 M-K 0.5 NA	2CDS 273 103 R0157	65944 4			0.500	1
1		S 203 M-K 1 NA	2CDS 273 103 R0217	65045 1			0.500	1	
1.6		S 203 M-K 1.6 NA	2CDS 273 103 R0257	65946 8			0.500	1	
2		S 203 M-K 2 NA	2CDS 273 103 R0277	65947 5			0.500	1	
3		S 203 M-K 3 NA	2CDS 273 103 R0317	65948 2			0.500	1	
4		S 203 M-K 4 NA	2CDS 273 103 R0337	65949 9			0.500	1	
6		S 203 M-K 6 NA	2CDS 273 103 R0377	65950 5			0.500	1	
8		S 203 M-K 8 NA	2CDS 273 103 R0407	65951 2			0.500	1	
10		S 203 M-K 10 NA	2CDS 273 103 R0427	65952 9			0.500	1	
13		S 203 M-K 13 NA	2CDS 273 103 R0447	65953 6			0.500	1	
16		S 203 M-K 16 NA	2CDS 273 103 R0467	65954 3			0.500	1	
20		S 203 M-K 20 NA	2CDS 273 103 R0487	65955 0			0.500	1	
25		S 203 M-K 25 NA	2CDS 273 103 R0517	65956 7			0.500	1	
32		S 203 M-K 32 NA	2CDS 273 103 R0537	65957 4			0.500	1	
U_{Bmax} 440 V ~	40	S 203 M-K 40 NA	2CDS 273 103 R0557	65958 1			0.500	1	
	50	S 203 M-K 50 NA	2CDS 273 103 R0577	65960 4			0.500	1	
	63	S 203 M-K 63 NA	2CDS 273 103 R0607	65961 1			0.500	1	

10000

Z



S 200 M-Z characteristic

Function: protection and control of the electronic circuits against weak and long duration overloads and short-circuits.

Applications: commercial and industrial.

Standard: IEC/EN 60947-2, VDE 0660 Part 101

Icu=10 kA (acc. to VDE 0660 Part 101)

Number of poles	Rated current	Order details	Bbn 4016779	Price 1 piece	Price group	Weight 1 piece	Pack unit	
								In A
1	0.5	S 201 M-Z 0.5	2CDS 271 001 R0158	59944 3		0.125	10	
	1	S 201 M-Z 1	2CDS 271 001 R0218	59948 1		0.125	10	
	1.6	S 201 M-Z 1.6	2CDS 271 001 R0258	59951 1		0.125	10	
	2	S 201 M-Z 2	2CDS 271 001 R0278	59953 5		0.125	10	
	3	S 201 M-Z 3	2CDS 271 001 R0318	59955 9		0.125	10	
	4	S 201 M-Z 4	2CDS 271 001 R0338	59958 0		0.125	10	
	6	S 201 M-Z 6	2CDS 271 001 R0378	59960 3		0.125	10	
	8	S 201 M-Z 8	2CDS 271 001 R0408	59963 4		0.125	10	
	10	S 201 M-Z 10	2CDS 271 001 R0428	59965 8		0.125	10	
	16	S 201 M-Z 16	2CDS 271 001 R0468	59967 2		0.125	10	
	20	S 201 M-Z 20	2CDS 271 001 R0488	59969 6		0.125	10	
	25	S 201 M-Z 25	2CDS 271 001 R0518	59972 6		0.125	10	
	32	S 201 M-Z 32	2CDS 271 001 R0538	59974 0		0.125	10	
	40	S 201 M-Z 40	2CDS 271 001 R0558	59976 4		0.125	10	
U _{Bmax} 253 V ~ 72 V ...	50	S 201 M-Z 50	2CDS 271 001 R0578	59978 8		0.125	10	
	63	S 201 M-Z 63	2CDS 271 001 R0608	59980 1		0.125	10	
	2	0.5	S 202 M-Z 0.5	2CDS 272 001 R0158	60049 1		0.250	5
		1	S 202 M-Z 1	2CDS 272 001 R0218	60053 8		0.250	5
1.6		S 202 M-Z 1.6	2CDS 272 001 R0258	60056 9		0.250	5	
2		S 202 M-Z 2	2CDS 272 001 R0278	60058 3		0.250	5	
3		S 202 M-Z 3	2CDS 272 001 R0318	60060 6		0.250	5	
4		S 202 M-Z 4	2CDS 272 001 R0338	60063 7		0.250	5	
6		S 202 M-Z 6	2CDS 272 001 R0378	60065 1		0.250	5	
8		S 202 M-Z 8	2CDS 272 001 R0408	60068 2		0.250	5	
10		S 202 M-Z 10	2CDS 272 001 R0428	60070 5		0.250	5	
16		S 202 M-Z 16	2CDS 272 001 R0468	60072 9		0.250	5	
20		S 202 M-Z 20	2CDS 272 001 R0488	60074 3		0.250	5	
25		S 202 M-Z 25	2CDS 272 001 R0518	60077 4		0.250	5	
32		S 202 M-Z 32	2CDS 272 001 R0538	60079 8		0.250	5	
40		S 202 M-Z 40	2CDS 272 001 R0558	60081 1		0.250	5	
U _{Bmax} 440 V ~ 125 V ...	50	S 202-M Z 50	2CDS 272 001 R0578	60083 5		0.250	5	
	63	S 202 M-Z 63	2CDS 272 001 R0608	60085 9		0.250	5	
3	0.5	S 203 M-Z 0.5	2CDS 273 001 R0158	60102 3		0.375	1	
	1	S 203 M-Z 1	2CDS 273 001 R0218	60106 1		0.375	1	
	1.6	S 203 M-Z 1.6	2CDS 273 001 R0258	60109 2		0.375	1	
	2	S 203 M-Z 2	2CDS 273 001 R0278	60111 5		0.375	1	
	3	S 203 M-Z 3	2CDS 273 001 R0318	60113 9		0.375	1	
	4	S 203 M-Z 4	2CDS 273 001 R0338	60116 0		0.375	1	
	6	S 203 M-Z 6	2CDS 273 001 R0378	60118 4		0.375	1	
	8	S 203 M-Z 8	2CDS 273 001 R0408	60121 4		0.375	1	
	10	S 203 M-Z 10	2CDS 273 001 R0428	60123 8		0.375	1	
	16	S 203 M-Z 16	2CDS 273 001 R0468	60125 2		0.375	1	
	20	S 203 M-Z 20	2CDS 273 001 R0488	60127 6		0.375	1	
	25	S 203 M-Z 25	2CDS 273 001 R0518	60130 6		0.375	1	
	32	S 203 M-Z 32	2CDS 273 001 R0538	60132 0		0.375	1	
	40	S 203 M-Z 40	2CDS 273 001 R0558	60134 4		0.375	1	
U _{Bmax} 440 V ~	50	S 203 M-Z 50	2CDS 273 001 R0578	60136 8		0.375	1	
	63	S 203 M-Z 63	2CDS 273 001 R0608	60138 2		0.375	1	

10000

2

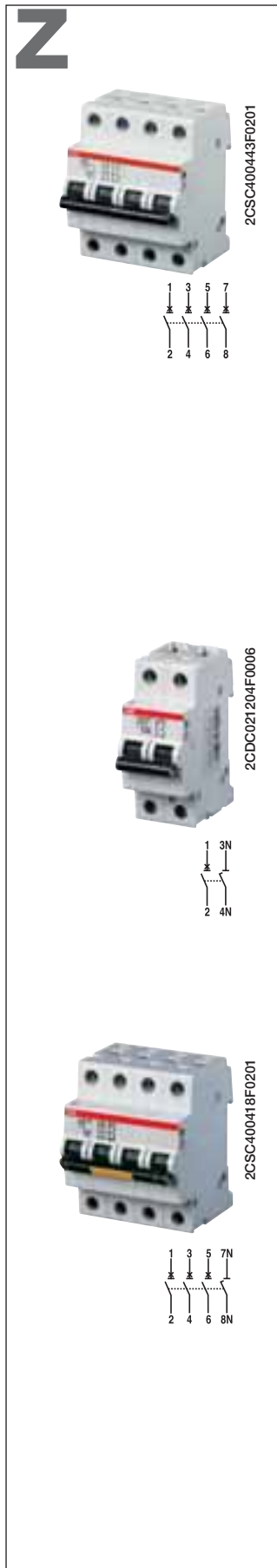

4	0.5	S 204 M-Z	0.5	2CDS 274 001 R0158	60176 4	0.500	1
	1	S 204 M-Z	1	2CDS 274 001 R0218	60181 0	0.500	1
	1.6	S 204 M-Z	1.6	2CDS 274 001 R0258	60183 2	0.500	1
	2	S 204 M-Z	2	2CDS 274 001 R0278	60185 6	0.500	1
	3	S 204 M-Z	3	2CDS 274 001 R0318	60187 0	0.500	1
	4	S 204 M-Z	4	2CDS 274 001 R0338	60190 0	0.500	1
	6	S 204 M-Z	6	2CDS 274 001 R0378	60192 4	0.500	1
	8	S 204 M-Z	8	2CDS 274 001 R0408	60195 5	0.500	1
	10	S 204 M-Z	10	2CDS 274 001 R0428	60197 9	0.500	1
	16	S 204 M-Z	16	2CDS 274 001 R0468	60199 3	0.500	1
	20	S 204 M-Z	20	2CDS 274 001 R0488	65962 8	0.500	1
	25	S 204 M-Z	25	2CDS 274 001 R0518	60203 7	0.500	1
	32	S 204 M-Z	32	2CDS 274 001 R0538	60205 1	0.500	1
	40	S 204 M-Z	40	2CDS 274 001 R0558	60207 5	0.500	1
50	S 204 M-Z	50	2CDS 274 001 R0578	60209 9	0.500	1	
63	S 204 M-Z	63	2CDS 274 001 R0608	60211 2	0.500	1	

U_{Bmax}
440 V ~
125 V ...

① U_{Bmax} 125 V ... with 2 poles connected in series

With disconnecting neutral NA

Number of poles	Rated current	Order details	Bbn 4016779	Price 1 piece	Price group	Weight 1 piece	Pack unit
	In A	Type code	Order code	EAN		kg	pc.
1 +	0.5	S 201 M-Z	0.5 NA	2CDS 271 103 R0158	59996 2	0.260	5
	1	S 201 M-Z	1 NA	2CDS 271 103 R0218	60000 2	0.260	5
	1.6	S 201 M-Z	1.6 NA	2CDS 271 103 R0258	60003 3	0.260	5
	2	S 201 M-Z	2 NA	2CDS 271 103 R0278	60005 7	0.260	5
	3	S 201 M-Z	3 NA	2CDS 271 103 R0318	60007 1	0.260	5
	4	S 201 M-Z	4 NA	2CDS 271 103 R0338	60010 1	0.260	5
	6	S 201 M-Z	6 NA	2CDS 271 103 R0378	60012 5	0.260	5
	8	S 201 M-Z	8 NA	2CDS 271 103 R0408	60015 6	0.260	5
	10	S 201 M-Z	10 NA	2CDS 271 103 R0428	60017 0	0.260	5
	16	S 201 M-Z	16 NA	2CDS 271 103 R0468	60019 4	0.260	5
	20	S 201 M-Z	20 NA	2CDS 271 103 R0488	60021 7	0.260	5
	25	S 201 M-Z	25 NA	2CDS 271 103 R0518	60024 8	0.260	5
	32	S 201 M-Z	32 NA	2CDS 271 103 R0538	60026 2	0.260	5
	40	S 201 M-Z	40 NA	2CDS 271 103 R0558	60028 6	0.260	5
50	S 201 M-Z	50 NA	2CDS 271 103 R0578	60030 9	0.320	5	
63	S 201 M-Z	63 NA	2CDS 271 103 R0608	60032 3	0.320	5	
3 +	0.5	S 203 M-Z	0.5 NA	2CDS 273 103 R0158	60147 4	0.520	1
	1	S 203 M-Z	1 NA	2CDS 273 103 R0218	60148 1	0.520	1
	1.6	S 203 M-Z	1.6 NA	2CDS 273 103 R0258	60149 8	0.520	1
	2	S 203 M-Z	2 NA	2CDS 273 103 R0278	60150 4	0.520	1
	3	S 203 M-Z	3 NA	2CDS 273 103 R0318	60151 1	0.520	1
	4	S 203 M-Z	4 NA	2CDS 273 103 R0338	60152 8	0.520	1
	6	S 203 M-Z	6 NA	2CDS 273 103 R0378	60153 5	0.520	1
	8	S 203 M-Z	8 NA	2CDS 273 103 R0408	60154 2	0.520	1
	10	S 203 M-Z	10 NA	2CDS 273 103 R0428	60155 9	0.520	1
	16	S 203 M-Z	16 NA	2CDS 273 103 R0468	60156 6	0.520	1
	20	S 203 M-Z	20 NA	2CDS 273 103 R0488	60157 3	0.520	1
	25	S 203 M-Z	25 NA	2CDS 273 103 R0518	60158 0	0.520	1
	32	S 203 M-Z	32 NA	2CDS 273 103 R0538	60159 7	0.520	1
	40	S 203 M-Z	40 NA	2CDS 273 103 R0558	60160 3	0.520	1
50	S 203 M-Z	50 NA	2CDS 273 103 R0578	60161 0	0.640	1	
63	S 203 M-Z	63 NA	2CDS 273 103 R0608	60162 7	0.640	1	

U_{Bmax}
253 V ~
72 V ...

U_{Bmax}
440 V ~

B

S 200 P-B characteristic

Function: protection and control of the circuits against overloads and short-circuits; protection for people and big length cables in TN and IT systems.

Applications: commercial and industrial.

Standard: IEC/EN 60898

$I_{cn}=25 \text{ kA}$ for $0.5 \text{ A} \leq I_n \leq 25 \text{ A}$

$I_{cn}=15 \text{ kA}$ for $32 \text{ A} \leq I_n \leq 63 \text{ A}$

Number of poles	Rated current	Order details	Bbn 4016779	Price 1 piece	Price group	Weight 1 piece	Pack unit
1	6	S 201 P-B 6	2CDS 281 001 R0065	589574		0.14	10
	10	S 201 P-B 10	2CDS 281 001 R0105	589581		0.14	10
	13	S 201 P-B 13	2CDS 281 001 R0135	589598		0.14	10
	16	S 201 P-B 16	2CDS 281 001 R0165	589260		0.14	10
	20	S 201 P-B 20	2CDS 281 001 R0205	589604		0.14	10
	25	S 201 P-B 25	2CDS 281 001 R0255	589611		0.14	10
	32	S 201 P-B 32	2CDS 281 001 R0325	589628		0.14	10
	40	S 201 P-B 40	2CDS 281 001 R0405	589635		0.14	10
	50	S 201 P-B 50	2CDS 281 001 R0505	589659		0.14	10
	63	S 201 P-B 63	2CDS 281 001 R0635	589666		0.14	10
$U_{Bmax} 253 \text{ V} \sim$ $72 \text{ V} \dots$							
2	6	S 202 P-B 6	2CDS 282 001 R0065	589673		0.28	5
	10	S 202 P-B 10	2CDS 282 001 R0105	589680		0.28	5
	13	S 202 P-B 13	2CDS 282 001 R0135	589697		0.28	5
	16	S 202 P-B 16	2CDS 282 001 R0165	589703		0.28	5
	20	S 202 P-B 20	2CDS 282 001 R0205	589710		0.28	5
	25	S 202 P-B 25	2CDS 282 001 R0255	589727		0.28	5
	32	S 202 P-B 32	2CDS 282 001 R0325	589734		0.28	5
	40	S 202 P-B 40	2CDS 282 001 R0405	589741		0.28	5
	50	S 202 P-B 50	2CDS 282 001 R0505	589758		0.28	5
	63	S 202 P-B 63	2CDS 282 001 R0635	589765		0.28	5
$U_{Bmax} 440 \text{ V} \sim$ $125 \text{ V} \dots$ ①							
3	6	S 203 P-B 6	2CDS 283 001 R0065	589772		0.42	1
	10	S 203 P-B 10	2CDS 283 001 R0105	589789		0.42	1
	13	S 203 P-B 13	2CDS 283 001 R0135	589796		0.42	1
	16	S 203 P-B 16	2CDS 283 001 R0165	589802		0.42	1
	20	S 203 P-B 20	2CDS 283 001 R0205	589819		0.42	1
	25	S 203 P-B 25	2CDS 283 001 R0255	589826		0.42	1
	32	S 203 P-B 32	2CDS 283 001 R0325	589833		0.42	1
	40	S 203 P-B 40	2CDS 283 001 R0405	589840		0.42	1
	50	S 203 P-B 50	2CDS 283 001 R0505	589857		0.42	1
	63	S 203 P-B 63	2CDS 283 001 R0635	589864		0.42	1
$U_{Bmax} 440 \text{ V} \sim$							
4	6	S 204 P-B 6	2CDS 284 001 R0065	589871		0.56	1
	10	S 204 P-B 10	2CDS 284 001 R0105	589888		0.56	1
	13	S 204 P-B 13	2CDS 284 001 R0135	589895		0.56	1
	16	S 204 P-B 16	2CDS 284 001 R0165	589901		0.56	1
	20	S 204 P-B 20	2CDS 284 001 R0205	589918		0.56	1
	25	S 204 P-B 25	2CDS 284 001 R0255	589925		0.56	1
	32	S 204 P-B 32	2CDS 284 001 R0325	589932		0.56	1
	40	S 204 P-B 40	2CDS 284 001 R0405	589949		0.56	1
	50	S 204 P-B 50	2CDS 284 001 R0505	589956		0.56	1
	63	S 204 P-B 63	2CDS 284 001 R0635	589963		0.56	1
$U_{Bmax} 440 \text{ V} \sim$ $125 \text{ V} \dots$ ①							

① $U_{Bmax} 125 \text{ V} \dots$ with 2 poles connected in series

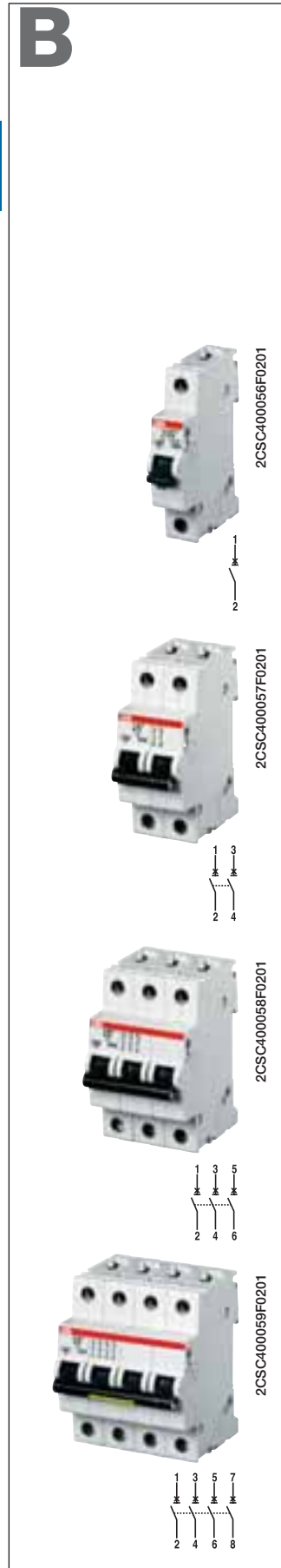

B



2CSC400060F0201



2CSC40062F0201



With disconnecting neutral NA

Number of poles	Rated current	Order details		Bbn 4016779	Price 1 piece	Price group	Weight 1 piece	Pack unit		
	In A	Type code	Order code	EAN			kg	pc.		
1 +	6	S 201 P-B 6 NA	2CDS 281 103 R0065	589970			0.28	5		
	10	S 201 P-B 10 NA	2CDS 281 103 R0105	589987			0.28	5		
	NA	13	S 201 P-B 13 NA	2CDS 281 103 R0135	589994			0.28	5	
		16	S 201 P-B 16 NA	2CDS 281 103 R0165	590006			0.28	5	
		20	S 201 P-B 20 NA	2CDS 281 103 R0205	590013			0.28	5	
		25	S 201 P-B 25 NA	2CDS 281 103 R0255	590020			0.28	5	
		32	S 201 P-B 32 NA	2CDS 281 103 R0325	590037			0.28	5	
		U _{Brmax} 253 V ~ 72 V ...	40	S 201 P-B 40 NA	2CDS 281 103 R0405	590044			0.28	5
			50	S 201 P-B 50 NA	2CDS 281 103 R0505	590051			0.28	5
			63	S 201 P-B 63 NA	2CDS 281 103 R0635	590068			0.28	5
3 +	6	S 203 P-B 6 NA	2CDS 283 103 R0065	590075			0.56	1		
	10	S 203 P-B 10 NA	2CDS 283 103 R0105	590082			0.56	1		
	NA	13	S 203 P-B 13 NA	2CDS 283 103 R0135	590099			0.56	1	
		16	S 203 P-B 16 NA	2CDS 283 103 R0165	590105			0.56	1	
		20	S 203 P-B 20 NA	2CDS 283 103 R0205	590112			0.56	1	
		25	S 203 P-B 25 NA	2CDS 283 103 R0255	590129			0.56	1	
		32	S 203 P-B 32 NA	2CDS 283 103 R0325	590136			0.56	1	
		40	S 203 P-B 40 NA	2CDS 283 103 R0405	590143			0.56	1	
		U _{Brmax} 440 V ~	50	S 203 P-B 50 NA	2CDS 283 103 R0505	590150			0.56	1
			63	S 203 P-B 63 NA	2CDS 283 103 R0635	590167			0.56	1

2

C

2



2CSC400056F0201



2CSC400057F0201



2CSC400058F0201

S 200 P-C characteristic

Function: protection and control of the circuits against overloads and short-circuits; protection for resistive and inductive loads with low inrush current.

Applications: commercial and industrial.

Standard: IEC/EN 60898

I_{cn}=25 kA for 0.5 A ≤ I_n ≤ 25 A

I_{cn}=15 kA for 32 A ≤ I_n ≤ 63 A

Number of poles	Rated current	Order details	Bbn 4016779	Price 1 piece	Price group	Weight 1 piece	Pack unit
	In A	Type code	Order code	EAN		kg	pc.
1	0.5	S 201 P-C 0.5	2CDS 281 001 R0984	590174		0.14	10
	1	S 201 P-C 1	2CDS 281 001 R0014	590181		0.14	10
	1.6	S 201 P-C 1.6	2CDS 281 001 R0974	590198		0.14	10
	2	S 201 P-C 2	2CDS 281 001 R0024	590204		0.14	10
	3	S 201 P-C 3	2CDS 281 001 R0034	590211		0.14	10
	4	S 201 P-C 4	2CDS 281 001 R0044	590228		0.14	10
	6	S 201 P-C 6	2CDS 281 001 R0064	590235		0.14	10
	8	S 201 P-C 8	2CDS 281 001 R0084	590242		0.14	10
	10	S 201 P-C 10	2CDS 281 001 R0104	590259		0.14	10
	13	S 201 P-C 13	2CDS 281 001 R0134	590266		0.14	10
	16	S 201 P-C 16	2CDS 281 001 R0164	590273		0.14	10
	20	S 201 P-C 20	2CDS 281 001 R0204	590280		0.14	10
	25	S 201 P-C 25	2CDS 281 001 R0254	590297		0.14	10
	32	S 201 P-C 32	2CDS 281 001 R0324	590303		0.14	10
	40	S 201 P-C 40	2CDS 281 001 R0404	590310		0.14	10
	50	S 201 P-C 50	2CDS 281 001 R0504	590327		0.14	10
63	S 201 P-C 63	2CDS 281 001 R0634	590334		0.14	10	
2	0.5	S 202 P-C 0.5	2CDS 282 001 R0984	590341		0.28	5
	1	S 202 P-C 1	2CDS 282 001 R0014	590358		0.28	5
	1.6	S 202 P-C 1.6	2CDS 282 001 R0974	590365		0.28	5
	2	S 202 P-C 2	2CDS 282 001 R0024	590372		0.28	5
	3	S 202 P-C 3	2CDS 282 001 R0034	590389		0.28	5
	4	S 202 P-C 4	2CDS 282 001 R0044	590396		0.28	5
	6	S 202 P-C 6	2CDS 282 001 R0064	590402		0.28	5
	8	S 202 P-C 8	2CDS 282 001 R0084	590419		0.28	5
	10	S 202 P-C 10	2CDS 282 001 R0104	590426		0.28	5
	13	S 202 P-C 13	2CDS 282 001 R0134	590433		0.28	5
	16	S 202 P-C 16	2CDS 282 001 R0164	590440		0.28	5
	20	S 202 P-C 20	2CDS 282 001 R0204	590457		0.28	5
	25	S 202 P-C 25	2CDS 282 001 R0254	590464		0.28	5
	32	S 202 P-C 32	2CDS 282 001 R0324	590471		0.28	5
	40	S 202 P-C 40	2CDS 282 001 R0404	590488		0.28	5
	50	S 202 P-C 50	2CDS 282 001 R0504	590495		0.28	5
63	S 202 P-C 63	2CDS 282 001 R0634	590501		0.28	5	
3	0.5	S 203 P-C 0.5	2CDS 283 001 R0984	590518		0.42	1
	1	S 203 P-C 1	2CDS 283 001 R0014	590525		0.42	1
	1.6	S 203 P-C 1.6	2CDS 283 001 R0974	590532		0.42	1
	2	S 203 P-C 2	2CDS 283 001 R0024	590549		0.42	1
	3	S 203 P-C 3	2CDS 283 001 R0034	590556		0.42	1
	4	S 203 P-C 4	2CDS 283 001 R0044	590563		0.42	1
	6	S 203 P-C 6	2CDS 283 001 R0064	590570		0.42	1
	8	S 203 P-C 8	2CDS 283 001 R0084	590587		0.42	1
	10	S 203 P-C 10	2CDS 283 001 R0104	590594		0.42	1
	13	S 203 P-C 13	2CDS 283 001 R0134	590600		0.42	1
	16	S 203 P-C 16	2CDS 283 001 R0164	590617		0.42	1
	20	S 203 P-C 20	2CDS 283 001 R0204	590624		0.42	1
	25	S 203 P-C 25	2CDS 283 001 R0254	590631		0.42	1
	32	S 203 P-C 32	2CDS 283 001 R0324	590648		0.42	1
	40	S 203 P-C 40	2CDS 283 001 R0404	590655		0.42	1
	50	S 203 P-C 50	2CDS 283 001 R0504	590662		0.42	1
63	S 203 P-C 63	2CDS 283 001 R0634	590679		0.42	1	

U_{Bmax}
253 V ~
72 V ...

U_{Bmax}
440 V ~
125 V ...

④

U_{Bmax}
440 V ~

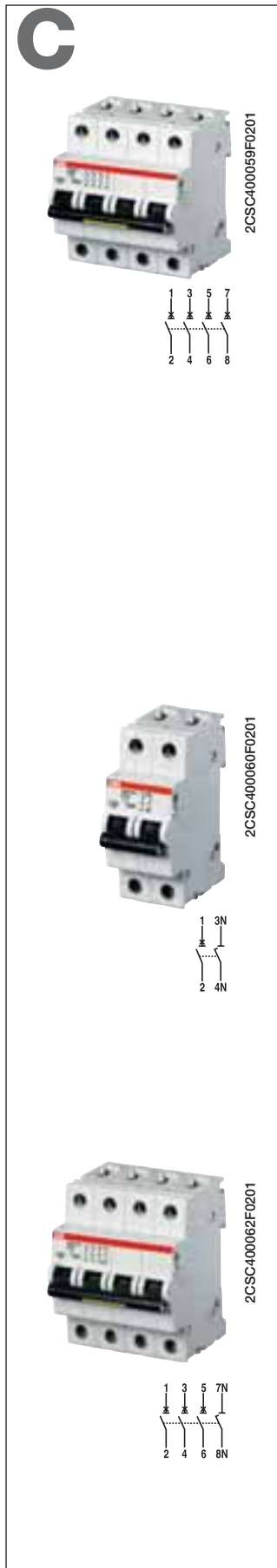

4	0.5	S 204 P-C 0.5	2CDS 284 001 R0984	590686	0.56	1
	1	S 204 P-C 1	2CDS 284 001 R0014	590693	0.56	1
	1.6	S 204 P-C 1.6	2CDS 284 001 R0974	590709	0.56	1
	2	S 204 P-C 2	2CDS 284 001 R0024	590716	0.56	1
	3	S 204 P-C 3	2CDS 284 001 R0034	590723	0.56	1
	4	S 204 P-C 4	2CDS 284 001 R0044	590730	0.56	1
	6	S 204 P-C 6	2CDS 284 001 R0064	590747	0.56	1
	8	S 204 P-C 8	2CDS 284 001 R0084	590754	0.56	1
	10	S 204 P-C 10	2CDS 284 001 R0104	590761	0.56	1
	13	S 204 P-C 13	2CDS 284 001 R0134	590778	0.56	1
	16	S 204 P-C 16	2CDS 284 001 R0164	590785	0.56	1
	20	S 204 P-C 20	2CDS 284 001 R0204	590792	0.56	1
	25	S 204 P-C 25	2CDS 284 001 R0254	590808	0.56	1
	32	S 204 P-C 32	2CDS 284 001 R0324	590815	0.56	1
	40	S 204 P-C 40	2CDS 284 001 R0404	590822	0.56	1
	50	S 204 P-C 50	2CDS 284 001 R0504	590839	0.56	1
63	S 204 P-C 63	2CDS 284 001 R0634	590846	0.56	1	

U_{Bmax} 440 V ~
125 V ...

④

- ① suitable for flow-type heaters 12 kW
- ② suitable for flow-type heaters 18 kW
- ③ suitable for flow-type heaters 21, 24 and 27 kW
- ④ U_{Bmax} 125 V ... with 2 poles connected in series

With disconnecting neutral NA

Number of poles	Rated current In A	Order details Type code	Order code	Bbn 4016779	Price 1 piece	Price group	Weight 1 piece kg	Pack unit pc.
				EAN				
1 + NA	0.5	S 201 P-C 0.5 NA	2CDS 281 103 R0984	590853			0.28	5
	1	S 201 P-C 1 NA	2CDS 281 103 R0014	590860			0.28	5
	1.6	S 201 P-C 1.6 NA	2CDS 281 103 R0974	590877			0.28	5
	2	S 201 P-C 2 NA	2CDS 281 103 R0024	590884			0.28	5
	3	S 201 P-C 3 NA	2CDS 281 103 R0034	590891			0.28	5
	4	S 201 P-C 4 NA	2CDS 281 103 R0044	590907			0.28	5
	6	S 201 P-C 6 NA	2CDS 281 103 R0064	590914			0.28	5
	8	S 201 P-C 8 NA	2CDS 281 103 R0084	590921			0.28	5
	10	S 201 P-C 10 NA	2CDS 281 103 R0104	590938			0.28	5
	13	S 201 P-C 13 NA	2CDS 281 103 R0134	590945			0.28	5
	16	S 201 P-C 16 NA	2CDS 281 103 R0164	590952			0.28	5
	20	S 201 P-C 20 NA	2CDS 281 103 R0204	590969			0.28	5
	25	S 201 P-C 25 NA	2CDS 281 103 R0254	590976			0.28	5
	32	S 201 P-C 32 NA	2CDS 281 103 R0324	590983			0.28	5
	40	S 201 P-C 40 NA	2CDS 281 103 R0404	590990			0.28	5
	50	S 201 P-C 50 NA	2CDS 281 103 R0504	591003			0.28	5
63	S 201 P-C 63 NA	2CDS 281 103 R0634	591010			0.28	5	
3 + NA	0.5	S 203 P-C 0.5 NA	2CDS 283 103 R0984	591027			0.56	1
	1	S 203 P-C 1 NA	2CDS 283 103 R0014	591034			0.56	1
	1.6	S 203 P-C 1.6 NA	2CDS 283 103 R0974	591041			0.56	1
	2	S 203 P-C 2 NA	2CDS 283 103 R0024	591058			0.56	1
	3	S 203 P-C 3 NA	2CDS 283 103 R0034	591065			0.56	1
	4	S 203 P-C 4 NA	2CDS 283 103 R0044	591072			0.56	1
	6	S 203 P-C 6 NA	2CDS 283 103 R0064	591089			0.56	1
	8	S 203 P-C 8 NA	2CDS 283 103 R0084	591096			0.56	1
	10	S 203 P-C 10 NA	2CDS 283 103 R0104	591102			0.56	1
	13	S 203 P-C 13 NA	2CDS 283 103 R0134	591119			0.56	1
	16	S 203 P-C 16 NA	2CDS 283 103 R0164	591126			0.56	1
	20	S 203 P-C 20 NA	2CDS 283 103 R0204	591133			0.56	1
	25	S 203 P-C 25 NA	2CDS 283 103 R0254	591140			0.56	1
	32	S 203 P-C 32 NA	2CDS 283 103 R0324	591157			0.56	1
	40	S 203 P-C 40 NA	2CDS 283 103 R0404	591164			0.56	1
	50	S 203 P-C 50 NA	2CDS 283 103 R0504	591171			0.56	1
63	S 203 P-C 63 NA	2CDS 283 103 R0634	591188			0.56	1	

U_{Bmax} 253 V ~
72 V ...

U_{Bmax} 440 V ~

D

S 200 P-D characteristic

Function: protection and control of the circuits against overloads and short-circuits; protection for circuits which supply loads with high inrush current at the circuit closing (LV/LV transformers, breakdown lamps).

Applications: commercial and industrial.

Standard: IEC/EN 60898

I_{cn}=25 kA for 0.5 A ≤ I_n ≤ 25 A

I_{cn}=15 kA for 32 A ≤ I_n ≤ 63 A

2



Number of poles	Rated current	Order details	Bbn 4016779	Price 1 piece	Price group	Weight 1 piece	Pack unit
In A	Type code	Order code	EAN			kg	pc.
1	0.5	S 201 P-D 0.5	2CDS 281 001 R0981	591195		0.14	10
	1	S 201 P-D 1	2CDS 281 001 R0011	591201		0.14	10
	1.6	S 201 P-D 1.6	2CDS 281 001 R0971	591218		0.14	10
	2	S 201 P-D 2	2CDS 281 001 R0021	591225		0.14	10
	3	S 201 P-D 3	2CDS 281 001 R0031	591232		0.14	10
	4	S 201 P-D 4	2CDS 281 001 R0041	591249		0.14	10
	6	S 201 P-D 6	2CDS 281 001 R0061	591256		0.14	10
	8	S 201 P-D 8	2CDS 281 001 R0081	591263		0.14	10
	10	S 201 P-D 10	2CDS 281 001 R0101	591270		0.14	10
	13	S 201 P-D 13	2CDS 281 001 R0131	591287		0.14	10
	16	S 201 P-D 16	2CDS 281 001 R0161	591294		0.14	10
	20	S 201 P-D 20	2CDS 281 001 R0201	591300		0.14	10
	25	S 201 P-D 25	2CDS 281 001 R0251	591317		0.14	10
	32	S 201 P-D 32	2CDS 281 001 R0321	591324		0.14	10
	40	S 201 P-D 40	2CDS 281 001 R0401	591331		0.14	10
50	S 201 P-D 50	2CDS 281 001 R0501	591348		0.14	10	
63	S 201 P-D 63	2CDS 281 001 R0631	591355		0.14	10	
2	0.5	S 202 P-D 0.5	2CDS 282 001 R0981	591362		0.28	5
	1	S 202 P-D 1	2CDS 282 001 R0011	591379		0.28	5
	1.6	S 202 P-D 1.6	2CDS 282 001 R0971	591386		0.28	5
	2	S 202 P-D 2	2CDS 282 001 R0021	591393		0.28	5
	3	S 202 P-D 3	2CDS 282 001 R0031	591409		0.28	5
	4	S 202 P-D 4	2CDS 282 001 R0041	591416		0.28	5
	6	S 202 P-D 6	2CDS 282 001 R0061	591423		0.28	5
	8	S 202 P-D 8	2CDS 282 001 R0081	591430		0.28	5
	10	S 202 P-D 10	2CDS 282 001 R0101	591447		0.28	5
	13	S 202 P-D 13	2CDS 282 001 R0131	591454		0.28	5
	16	S 202 P-D 16	2CDS 282 001 R0161	591461		0.28	5
	20	S 202 P-D 20	2CDS 282 001 R0201	591478		0.28	5
	25	S 202 P-D 25	2CDS 282 001 R0251	591485		0.28	5
	32	S 202 P-D 32	2CDS 282 001 R0321	591492		0.28	5
	40	S 202 P-D 40	2CDS 282 001 R0401	591508		0.28	5
50	S 202 P-D 50	2CDS 282 001 R0501	591515		0.28	5	
63	S 202 P-D 63	2CDS 282 001 R0631	591522		0.28	5	
3	0.5	S 203 P-D 0.5	2CDS 283 001 R0981	591539		0.42	1
	1	S 203 P-D 1	2CDS 283 001 R0011	591546		0.42	1
	1.6	S 203 P-D 1.6	2CDS 283 001 R0971	591553		0.42	1
	2	S 203 P-D 2	2CDS 283 001 R0021	591560		0.42	1
	3	S 203 P-D 3	2CDS 283 001 R0031	591577		0.42	1
	4	S 203 P-D 4	2CDS 283 001 R0041	591584		0.42	1
	6	S 203 P-D 6	2CDS 283 001 R0061	591591		0.42	1
	8	S 203 P-D 8	2CDS 283 001 R0081	591607		0.42	1
	10	S 203 P-D 10	2CDS 283 001 R0101	591614		0.42	1
	13	S 203 P-D 13	2CDS 283 001 R0131	591621		0.42	1
	16	S 203 P-D 16	2CDS 283 001 R0161	591638		0.42	1
	20	S 203 P-D 20	2CDS 283 001 R0201	591645		0.42	1
	25	S 203 P-D 25	2CDS 283 001 R0251	591652		0.42	1
	32	S 203 P-D 32	2CDS 283 001 R0321	591669		0.42	1
	40	S 203 P-D 40	2CDS 283 001 R0401	591676		0.42	1
50	S 203 P-D 50	2CDS 283 001 R0501	591683		0.42	1	
63	S 203 P-D 63	2CDS 283 001 R0631	591690		0.42	1	

U_{Bmax}
253 V ~
72 V ...

U_{Bmax}
440 V ~
125 V ...
④

U_{Bmax}
440 V ~

D



Number of poles	Rated current	Order details	Bbn 4016779	Price 1 piece	Price group	Weight 1 piece	Pack unit
4	0.5	S 204 P-D 0.5	2CDS 284 001 R0981	591706		0.56	1
	1	S 204 P-D 1	2CDS 284 001 R0011	591713		0.56	1
	1.6	S 204 P-D 1.6	2CDS 284 001 R0971	591720		0.56	1
	2	S 204 P-D 2	2CDS 284 001 R0021	591737		0.56	1
	3	S 204 P-D 3	2CDS 284 001 R0031	591744		0.56	1
	4	S 204 P-D 4	2CDS 284 001 R0041	591751		0.56	1
	6	S 204 P-D 6	2CDS 284 001 R0061	591768		0.56	1
	8	S 204 P-D 8	2CDS 284 001 R0081	591775		0.56	1
	10	S 204 P-D 10	2CDS 284 001 R0101	591782		0.56	1
	13	S 204 P-D 13	2CDS 284 001 R0131	591799		0.56	1
	16	S 204 P-D 16	2CDS 284 001 R0161	591805		0.56	1
	20	S 204 P-D 20	2CDS 284 001 R0201	591812		0.56	1
	25	S 204 P-D 25	2CDS 284 001 R0251	591829		0.56	1
	32	S 204 P-D 32	2CDS 284 001 R0321	591836		0.56	1
U _{Bmax} 440 V ~ 125 V ...	40	S 204 P-D 40	2CDS 284 001 R0401	591843		0.56	1
	50	S 204 P-D 50	2CDS 284 001 R0501	591850		0.56	1
	63	S 204 P-D 63	2CDS 284 001 R0631	591867		0.56	1

- ① suitable for flow-type heaters 12 kW
 ② suitable for flow-type heaters 18 kW
 ③ suitable for flow-type heaters 21, 24 and 27 kW
 ④ U_{Bmax} 125 V ... with 2 poles connected in series

With disconnecting neutral NA



Number of poles	Rated current	Order details	Bbn 4016779	Price 1 piece	Price group	Weight 1 piece	Pack unit
1 + NA	0.5	S 201 P-D 0.5 NA	2CDS 281 103 R0981	591874		0.28	5
	1	S 201 P-D 1 NA	2CDS 281 103 R0011	591881		0.28	5
	1.6	S 201 P-D 1.6 NA	2CDS 281 103 R0971	591898		0.28	5
	2	S 201 P-D 2 NA	2CDS 281 103 R0021	591904		0.28	5
	3	S 201 P-D 3 NA	2CDS 281 103 R0031	591911		0.28	5
	4	S 201 P-D 4 NA	2CDS 281 103 R0041	591928		0.28	5
	6	S 201 P-D 6 NA	2CDS 281 103 R0061	591935		0.28	5
	8	S 201 P-D 8 NA	2CDS 281 103 R0081	591942		0.28	5
	10	S 201 P-D 10 NA	2CDS 281 103 R0101	591959		0.28	5
	13	S 201 P-D 13 NA	2CDS 281 103 R0131	591966		0.28	5
	16	S 201 P-D 16 NA	2CDS 281 103 R0161	591973		0.28	5
	20	S 201 P-D 20 NA	2CDS 281 103 R0201	591980		0.28	5
	25	S 201 P-D 25 NA	2CDS 281 103 R0251	591997		0.28	5
	32	S 201 P-D 32 NA	2CDS 281 103 R0321	592000		0.28	5
U _{Bmax} 253 V ~ 72 V ...	40	S 201 P-D 40 NA	2CDS 281 103 R0401	592017		0.28	5
	50	S 201 P-D 50 NA	2CDS 281 103 R0501	592024		0.28	5
	63	S 201 P-D 63 NA	2CDS 281 103 R0631	592031		0.28	5



Number of poles	Rated current	Order details	Bbn 4016779	Price 1 piece	Price group	Weight 1 piece	Pack unit
3 + NA	0.5	S 203 P-D 0.5 NA	2CDS 283 103 R0981	592048		0.56	1
	1	S 203 P-D 1 NA	2CDS 283 103 R0011	592055		0.56	1
	1.6	S 203 P-D 1.6 NA	2CDS 283 103 R0971	592062		0.56	1
	2	S 203 P-D 2 NA	2CDS 283 103 R0021	592079		0.56	1
	3	S 203 P-D 3 NA	2CDS 283 103 R0031	592086		0.56	1
	4	S 203 P-D 4 NA	2CDS 283 103 R0041	592093		0.56	1
	6	S 203 P-D 6 NA	2CDS 283 103 R0061	592109		0.56	1
	8	S 203 P-D 8 NA	2CDS 283 103 R0081	592116		0.56	1
	10	S 203 P-D 10 NA	2CDS 283 103 R0101	592123		0.56	1
	13	S 203 P-D 13 NA	2CDS 283 103 R0131	592130		0.56	1
	16	S 203 P-D 16 NA	2CDS 283 103 R0161	592147		0.56	1
	20	S 203 P-D 20 NA	2CDS 283 103 R0201	592154		0.56	1
	25	S 203 P-D 25 NA	2CDS 283 103 R0251	592161		0.56	1
	32	S 203 P-D 32 NA	2CDS 283 103 R0321	592178		0.56	1
U _{Bmax} 440 V ~	40	S 203 P-D 40 NA	2CDS 283 103 R0401	592185		0.56	1
	50	S 203 P-D 50 NA	2CDS 283 103 R0501	592192		0.56	1
	63	S 203 P-D 63 NA	2CDS 283 103 R0631	592208		0.56	1

K

2

S 200 P-K (power) characteristic

Function: protection and control of the circuits like motors, transformers and auxiliary circuits, against overloads and short-circuits.

Advantages: no nuisance tripping in the case of functional peak currents up to 10xI_n, depending on the series; through its highly sensitive thermostatic bimetal trip, the K-type characteristic offers protection to damageable elements in the overcurrent range; it also provides the best protection to cables and lines.

Applications: commercial and industrial.

Standard: IEC/EN 60947-2, VDE 0660 Part 101

I_{cu}=25 kA for 0.5 A ≤ I_n ≤ 25 A; I_{cu}=15 kA for 32 A ≤ I_n ≤ 63 A (acc. to VDE 0660 Part 101)



Number of poles	Rated current	Order details	Bbn 4016779	Price 1 piece	Price group	Weight 1 piece	Pack unit
In A	Type code	Order code	EAN			kg	pc.
1	0.2	S 201 P-K 0.2	2CDS 281 001 R0087	592215		0.14	10
	0.3	S 201 P-K 0.3	2CDS 281 001 R0117	592222		0.14	10
	0.5	S 201 P-K 0.5	2CDS 281 001 R0157	592239		0.14	10
	0.75	S 201 P-K 0.75	2CDS 281 001 R0187	592246		0.14	10
	1	S 201 P-K 1	2CDS 281 001 R0217	592253		0.14	10
	1.6	S 201 P-K 1.6	2CDS 281 001 R0257	592260		0.14	10
	2	S 201 P-K 2	2CDS 281 001 R0277	592277		0.14	10
	3	S 201 P-K 3	2CDS 281 001 R0317	592284		0.14	10
	4	S 201 P-K 4	2CDS 281 001 R0337	592291		0.14	10
	6	S 201 P-K 6	2CDS 281 001 R0377	592307		0.14	10
	8	S 201 P-K 8	2CDS 281 001 R0407	592314		0.14	10
	10	S 201 P-K 10	2CDS 281 001 R0427	592321		0.14	10
	13	S 201 P-K 13	2CDS 281 001 R0447	592338		0.14	10
	16	S 201 P-K 16	2CDS 281 001 R0467	592345		0.14	10
	20	S 201 P-K 20	2CDS 281 001 R0487	592352		0.14	10
	25	S 201 P-K 25	2CDS 281 001 R0517	592369		0.14	10
32	S 201 P-K 32	2CDS 281 001 R0537	592376		0.14	10	
40	S 201 P-K 40	2CDS 281 001 R0557	592383		0.14	10	
50	S 201 P-K 50	2CDS 281 001 R0577	592390		0.14	10	
63	S 201 P-K 63	2CDS 281 001 R0607	592406		0.14	10	
U _{Bmax} 253 V ~ 72 V ...							



2	0.2	S 202 P-K 0.2	2CDS 282 001 R0087	592413		0.28	5
	0.3	S 202 P-K 0.3	2CDS 282 001 R0117	592420		0.28	5
	0.5	S 202 P-K 0.5	2CDS 282 001 R0157	592437		0.28	5
	0.75	S 202 P-K 0.75	2CDS 282 001 R0187	592444		0.28	5
	1	S 202 P-K 1	2CDS 282 001 R0217	592451		0.28	5
	1.6	S 202 P-K 1.6	2CDS 282 001 R0257	592468		0.28	5
	2	S 202 P-K 2	2CDS 282 001 R0277	592475		0.28	5
	3	S 202 P-K 3	2CDS 282 001 R0317	592482		0.28	5
	4	S 202 P-K 4	2CDS 282 001 R0337	592499		0.28	5
	6	S 202 P-K 6	2CDS 282 001 R0377	592505		0.28	5
	8	S 202 P-K 8	2CDS 282 001 R0407	592512		0.28	5
	10	S 202 P-K 10	2CDS 282 001 R0427	592529		0.28	5
	13	S 202 P-K 13	2CDS 282 001 R0447	592536		0.28	5
	16	S 202 P-K 16	2CDS 282 001 R0467	592543		0.28	5
	20	S 202 P-K 20	2CDS 282 001 R0487	592550		0.28	5
	25	S 202 P-K 25	2CDS 282 001 R0517	592567		0.28	5
32	S 202 P-K 32	2CDS 282 001 R0537	592574		0.28	5	
40	S 202 P-K 40	2CDS 282 001 R0557	592581		0.28	5	
50	S 202 P-K 50	2CDS 282 001 R0577	592598		0.28	5	
63	S 202 P-K 63	2CDS 282 001 R0607	592604		0.28	5	
U _{Bmax} 440 V ~ 125 V ...							



3	0.2	S 203 P-K 0.2	2CDS 283 001 R0087	592611		0.42	1
	0.3	S 203 P-K 0.3	2CDS 283 001 R0117	592628		0.42	1
	0.5	S 203 P-K 0.5	2CDS 283 001 R0157	592635		0.42	1
	0.75	S 203 P-K 0.75	2CDS 283 001 R0187	592642		0.42	1
	1	S 203 P-K 1	2CDS 283 001 R0217	592659		0.42	1
	1.6	S 203 P-K 1.6	2CDS 283 001 R0257	592666		0.42	1
	2	S 203 P-K 2	2CDS 283 001 R0277	592673		0.42	1
	3	S 203 P-K 3	2CDS 283 001 R0317	592680		0.42	1
	4	S 203 P-K 4	2CDS 283 001 R0337	592697		0.42	1
	6	S 203 P-K 6	2CDS 283 001 R0377	592703		0.42	1
	8	S 203 P-K 8	2CDS 283 001 R0407	592710		0.42	1
	10	S 203 P-K 10	2CDS 283 001 R0427	592727		0.42	1
13	S 203 P-K 13	2CDS 283 001 R0447	592734		0.42	1	
16	S 203 P-K 16	2CDS 283 001 R0467	592741		0.42	1	
20	S 203 P-K 20	2CDS 283 001 R0487	592758		0.42	1	
U _{Bmax} 440 V ~							



25	S 203 P-K 25	2CDS 283 001 R0517	592765	0.42	1
32	S 203 P-K 32	2CDS 283 001 R0537	592772	0.42	1
40	S 203 P-K 40	2CDS 283 001 R0557	592789	0.42	1
50	S 203 P-K 50	2CDS 283 001 R0577	592796	0.42	1
63	S 203 P-K 63	2CDS 283 001 R0607	592802	0.42	1
<hr/>					
4	0.2 S 204 P-K 0.2	2CDS 284 001 R0087	592819	0.56	1
	0.3 S 204 P-K 0.3	2CDS 284 001 R0117	592826	0.56	1
	0.5 S 204 P-K 0.5	2CDS 284 001 R0157	592833	0.56	1
	0.75 S 204 P-K 0.75	2CDS 284 001 R0187	592840	0.56	1
	1 S 204 P-K 1	2CDS 284 001 R0217	592857	0.56	1
	1.6 S 204 P-K 1.6	2CDS 284 001 R0257	592864	0.56	1
	2 S 204 P-K 2	2CDS 284 001 R0277	592871	0.56	1
	3 S 204 P-K 3	2CDS 284 001 R0317	592888	0.56	1
	4 S 204 P-K 4	2CDS 284 001 R0337	592895	0.56	1
	6 S 204 P-K 6	2CDS 284 001 R0377	592901	0.56	1
	8 S 204 P-K 8	2CDS 284 001 R0407	592918	0.56	1
	10 S 204 P-K 10	2CDS 284 001 R0427	592925	0.56	1
	13 S 204 P-K 13	2CDS 284 001 R0447	592932	0.56	1
	16 S 204 P-K 16	2CDS 284 001 R0467	592949	0.56	1
	20 S 204 P-K 20	2CDS 284 001 R0487	592956	0.56	1
	25 S 204 P-K 25	2CDS 284 001 R0517	592963	0.56	1
	32 S 204 P-K 32	2CDS 284 001 R0537	592970	0.56	1
	40 S 204 P-K 40	2CDS 284 001 R0557	592987	0.56	1
	50 S 204 P-K 50	2CDS 284 001 R0577	592994	0.56	1
	63 S 204 P-K 63	2CDS 284 001 R0607	593007	0.56	1

U_{Bmax}
440 V ~
60 V ...

① U_{Bmax} 125 V ... with 2 poles connected in series

With disconnecting neutral NA

Number of poles	Rated current	Order details	Bbn 4016779	Price 1 piece	Price group	Weight 1 piece	Pack unit
	In A	Type code	Order code	EAN		kg	pc.
1 + NA	0.2	S 201 P-K 0.2 NA	2CDS 281 103 R0087	593014		0.28	5
	0.3	S 201 P-K 0.3 NA	2CDS 281 103 R0117	593021		0.28	5
	0.5	S 201 P-K 0.5 NA	2CDS 281 103 R0157	593038		0.28	5
	0.75	S 201 P-K 0.75 NA	2CDS 281 103 R0187	593045		0.28	5
	1	S 201 P-K 1 NA	2CDS 281 103 R0217	593052		0.28	5
	1.6	S 201 P-K 1.6 NA	2CDS 281 103 R0257	593069		0.28	5
	2	S 201 P-K 2 NA	2CDS 281 103 R0277	593076		0.28	5
	3	S 201 P-K 3 NA	2CDS 281 103 R0317	593083		0.28	5
	4	S 201 P-K 4 NA	2CDS 281 103 R0337	593090		0.28	5
	6	S 201 P-K 6 NA	2CDS 281 103 R0377	593106		0.28	5
	8	S 201 P-K 8 NA	2CDS 281 103 R0407	593113		0.28	5
	10	S 201 P-K 10 NA	2CDS 281 103 R0427	593120		0.28	5
	13	S 201 P-K 13 NA	2CDS 281 103 R0447	593137		0.28	5
	16	S 201 P-K 16 NA	2CDS 281 103 R0467	593144		0.28	5
	20	S 201 P-K 20 NA	2CDS 281 103 R0487	593151		0.28	5
	25	S 201 P-K 25 NA	2CDS 281 103 R0517	593168		0.28	5
32	S 201 P-K 32 NA	2CDS 281 103 R0537	593175		0.28	5	
40	S 201 P-K 40 NA	2CDS 281 103 R0557	593182		0.28	5	
50	S 201 P-K 50 NA	2CDS 281 103 R0577	593199		0.28	5	
63	S 201 P-K 63 NA	2CDS 281 103 R0607	593205		0.28	5	
<hr/>							
3 + NA	0.2	S 203 P-K 0.2 NA	2CDS 283 103 R0087	593212		0.56	2
	0.3	S 203 P-K 0.3 NA	2CDS 283 103 R0117	593229		0.56	2
	0.5	S 203 P-K 0.5 NA	2CDS 283 103 R0157	593236		0.56	2
	0.75	S 203 P-K 0.75 NA	2CDS 283 103 R0187	593243		0.56	2
	1	S 203 P-K 1 NA	2CDS 283 103 R0217	593250		0.56	2
	1.6	S 203 P-K 1.6 NA	2CDS 283 103 R0257	593267		0.56	2
	2	S 203 P-K 2 NA	2CDS 283 103 R0277	593274		0.56	2
	3	S 203 P-K 3 NA	2CDS 283 103 R0317	593281		0.56	2
	4	S 203 P-K 4 NA	2CDS 283 103 R0337	593298		0.56	2
	6	S 203 P-K 6 NA	2CDS 283 103 R0377	593304		0.56	2
	8	S 203 P-K 8 NA	2CDS 283 103 R0407	593311		0.56	2
	10	S 203 P-K 10 NA	2CDS 283 103 R0427	593328		0.56	2
	13	S 203 P-K 13 NA	2CDS 283 103 R0447	593335		0.56	2
	16	S 203 P-K 16 NA	2CDS 283 103 R0467	593342		0.56	2
	20	S 203 P-K 20 NA	2CDS 283 103 R0487	593359		0.56	2
	25	S 203 P-K 25 NA	2CDS 283 103 R0517	593366		0.56	2
32	S 203 P-K 32 NA	2CDS 283 103 R0537	593373		0.56	2	
40	S 203 P-K 40 NA	2CDS 283 103 R0557	593380		0.56	2	
50	S 203 P-K 50 NA	2CDS 283 103 R0577	593397		0.56	2	
63	S 203 P-K 63 NA	2CDS 283 103 R0607	593403		0.56	2	

U_{Bmax}
253 V ~
72 V ...

U_{Bmax}
440 V ~

Z

2



2CSC400002F0201



2CSC400004F0201



2CSC400128F0201



S 200 P-Z characteristic

Function: protection and control of the electronic circuits against weak and long duration overloads and short-circuits.

Applications: commercial and industrial.

Standard: IEC/EN 60947-2, VDE 0660 Part 101

I_{cu}=25 kA for 0.5 A ≤ I_n ≤ 25 A; I_{cu}=15 kA for 32 A ≤ I_n ≤ 63 A (acc. to VDE 0660 Part 101)

Number of poles	Rated current	Order details	Bbn 4016779	Price 1 piece	Price group	Weight 1 piece	Pack unit
In A	Type code	Order code	EAN			kg	pc.
1	0.5	S 201 P-Z 0.5	2CDS 281 001 R0158	593410		0.14	10
	1	S 201 P-Z 1	2CDS 281 001 R0218	593427		0.14	10
	1.6	S 201 P-Z 1.6	2CDS 281 001 R0258	593434		0.14	10
	2	S 201 P-Z 2	2CDS 281 001 R0278	593441		0.14	10
	3	S 201 P-Z 3	2CDS 281 001 R0318	593458		0.14	10
	4	S 201 P-Z 4	2CDS 281 001 R0338	593465		0.14	10
	6	S 201 P-Z 6	2CDS 281 001 R0378	593472		0.14	10
	8	S 201 P-Z 8	2CDS 281 001 R0408	593489		0.14	10
	10	S 201 P-Z 10	2CDS 281 001 R0428	593496		0.14	10
	16	S 201 P-Z 16	2CDS 281 001 R0468	593502		0.14	10
	20	S 201 P-Z 20	2CDS 281 001 R0488	593519		0.14	10
	25	S 201 P-Z 25	2CDS 281 001 R0518	593526		0.14	10
	32	S 201 P-Z 32	2CDS 281 001 R0538	593533		0.14	10
	40	S 201 P-Z 40	2CDS 281 001 R0558	593540		0.14	10
50	S 201 P-Z 50	2CDS 281 001 R0578	593557		0.14	10	
63	S 201 P-Z 63	2CDS 281 001 R0608	593564		0.14	10	
U _{Bmax} 253 V ~ 72 V ...							
2	0.5	S 202 P-Z 0.5	2CDS 282 001 R0158	593571		0.28	5
	1	S 202 P-Z 1	2CDS 282 001 R0218	593588		0.28	5
	1.6	S 202 P-Z 1.6	2CDS 282 001 R0258	593595		0.28	5
	2	S 202 P-Z 2	2CDS 282 001 R0278	593601		0.28	5
	3	S 202 P-Z 3	2CDS 282 001 R0318	593618		0.28	5
	4	S 202 P-Z 4	2CDS 282 001 R0338	593625		0.28	5
	6	S 202 P-Z 6	2CDS 282 001 R0378	593632		0.28	5
	8	S 202 P-Z 8	2CDS 282 001 R0408	593649		0.28	5
	10	S 202 P-Z 10	2CDS 282 001 R0428	593656		0.28	5
	16	S 202 P-Z 16	2CDS 282 001 R0468	593663		0.28	5
	20	S 202 P-Z 20	2CDS 282 001 R0488	593670		0.28	5
	25	S 202 P-Z 25	2CDS 282 001 R0518	593687		0.28	5
	32	S 202 P-Z 32	2CDS 282 001 R0538	593694		0.28	5
	40	S 202 P-Z 40	2CDS 282 001 R0558	593700		0.28	5
50	S 202 P-Z 50	2CDS 282 001 R0578	593717		0.28	5	
63	S 202 P-Z 63	2CDS 282 001 R0608	593724		0.28	5	
U _{Bmax} 440 V ~ 125 V ... ①							
3	0.5	S 203 P-Z 0.5	2CDS 283 001 R0158	593731		0.42	1
	1	S 203 P-Z 1	2CDS 283 001 R0218	593748		0.42	1
	1.6	S 203 P-Z 1.6	2CDS 283 001 R0258	593755		0.42	1
	2	S 203 P-Z 2	2CDS 283 001 R0278	593762		0.42	1
	3	S 203 P-Z 3	2CDS 283 001 R0318	593779		0.42	1
	4	S 203 P-Z 4	2CDS 283 001 R0338	593786		0.42	1
	6	S 203 P-Z 6	2CDS 283 001 R0378	593793		0.42	1
	8	S 203 P-Z 8	2CDS 283 001 R0408	593809		0.42	1
	10	S 203 P-Z 10	2CDS 283 001 R0428	593816		0.42	1
	16	S 203 P-Z 16	2CDS 283 001 R0468	593823		0.42	1
	20	S 203 P-Z 20	2CDS 283 001 R0488	593830		0.42	1
	25	S 203 P-Z 25	2CDS 283 001 R0518	593847		0.42	1
	32	S 203 P-Z 32	2CDS 283 001 R0538	593854		0.42	1
	40	S 203 P-Z 40	2CDS 283 001 R0558	593861		0.42	1
50	S 203 P-Z 50	2CDS 283 001 R0578	593878		0.42	1	
63	S 203 P-Z 63	2CDS 283 001 R0608	593885		0.42	1	
U _{Bmax} 440 V ~							



4	0.5	S 204 P-Z 0.5	2CDS 284 001 R0158	593892	0.56	1
	1	S 204 P-Z 1	2CDS 284 001 R0218	593908	0.56	1
	1.6	S 204 P-Z 1.6	2CDS 284 001 R0258	593915	0.56	1
	2	S 204 P-Z 2	2CDS 284 001 R0278	593922	0.56	1
	3	S 204 P-Z 3	2CDS 284 001 R0318	593939	0.56	1
	4	S 204 P-Z 4	2CDS 284 001 R0338	593946	0.56	1
	6	S 204 P-Z 6	2CDS 284 001 R0378	593953	0.56	1
	8	S 204 P-Z 8	2CDS 284 001 R0408	593960	0.56	1
	10	S 204 P-Z 10	2CDS 284 001 R0428	593977	0.56	1
	16	S 204 P-Z 16	2CDS 284 001 R0468	593984	0.56	1
	20	S 204 P-Z 20	2CDS 284 001 R0488	593991	0.56	1
	25	S 204 P-Z 25	2CDS 284 001 R0518	594004	0.56	1
	32	S 204 P-Z 32	2CDS 284 001 R0538	594011	0.56	1
	40	S 204 P-Z 40	2CDS 284 001 R0558	594028	0.56	1
50	S 204 P-Z 50	2CDS 284 001 R0578	594035	0.56	1	
①	63	S 204 P-Z 63	2CDS 284 001 R0608	594042	0.56	1

U_{Bmax}
440 V ~
125 V ...

① U_{Bmax} 125 V ... with 2 poles connected in series

With disconnecting neutral NA

Number of poles	Rated current In A	Order details Type code	Order code	Bbn 4016779 EAN	Price 1 piece	Price group	Weight 1 piece kg	Pack unit pc.
1 + NA	0.5	S 201 P-Z 0.5 NA	2CDS 281 103 R0158	594059			0.28	5
	1	S 201 P-Z 1 NA	2CDS 281 103 R0218	594066			0.28	5
	1.6	S 201 P-Z 1.6 NA	2CDS 281 103 R0258	594073			0.28	5
	2	S 201 P-Z 2 NA	2CDS 281 103 R0278	594080			0.28	5
	3	S 201 P-Z 3 NA	2CDS 281 103 R0318	594097			0.28	5
	4	S 201 P-Z 4 NA	2CDS 281 103 R0338	594103			0.28	5
	6	S 201 P-Z 6 NA	2CDS 281 103 R0378	594110			0.28	5
	8	S 201 P-Z 8 NA	2CDS 281 103 R0408	594127			0.28	5
	10	S 201 P-Z 10 NA	2CDS 281 103 R0428	594134			0.28	5
	16	S 201 P-Z 16 NA	2CDS 281 103 R0468	594141			0.28	5
	20	S 201 P-Z 20 NA	2CDS 281 103 R0488	594158			0.28	5
	25	S 201 P-Z 25 NA	2CDS 281 103 R0518	594165			0.28	5
	32	S 201 P-Z 32 NA	2CDS 281 103 R0538	594172			0.28	5
	40	S 201 P-Z 40 NA	2CDS 281 103 R0558	594189			0.28	5
50	S 201 P-Z 50 NA	2CDS 281 103 R0578	594196			0.28	5	
63	S 201 P-Z 63 NA	2CDS 281 103 R0608	594202			0.28	5	
3 + NA	0.5	S 203 P-Z 0.5 NA	2CDS 283 103 R0158	594219			0.56	1
	1	S 203 P-Z 1 NA	2CDS 283 103 R0218	594226			0.56	1
	1.6	S 203 P-Z 1.6 NA	2CDS 283 103 R0258	594233			0.56	1
	2	S 203 P-Z 2 NA	2CDS 283 103 R0278	594240			0.56	1
	3	S 203 P-Z 3 NA	2CDS 283 103 R0318	594257			0.56	1
	4	S 203 P-Z 4 NA	2CDS 283 103 R0338	594264			0.56	1
	6	S 203 P-Z 6 NA	2CDS 283 103 R0378	594271			0.56	1
	8	S 203 P-Z 8 NA	2CDS 283 103 R0408	594288			0.56	1
	10	S 203 P-Z 10 NA	2CDS 283 103 R0428	594295			0.56	1
	16	S 203 P-Z 16 NA	2CDS 283 103 R0468	594301			0.56	1
	20	S 203 P-Z 20 NA	2CDS 283 103 R0488	594318			0.56	1
	25	S 203 P-Z 25 NA	2CDS 283 103 R0518	594325			0.56	1
	32	S 203 P-Z 32 NA	2CDS 283 103 R0538	594332			0.56	1
	40	S 203 P-Z 40 NA	2CDS 283 103 R0558	594349			0.56	1
50	S 203 P-Z 50 NA	2CDS 283 103 R0578	594356			0.56	1	
63	S 203 P-Z 63 NA	2CDS 283 103 R0608	594363			0.56	1	

U_{Bmax}
253 V ~
72 V ...

U_{Bmax}
440 V ~

10000

K

S 200 U-K characteristic

Function: protection and control of the circuits like motors, transformers and auxiliary circuits, against overloads and short-circuits.

Advantages: no nuisance tripping in the case of functional peak currents up to 10xI_n, depending on the series; through its highly sensitive thermostatic bimetal trip, the K-type characteristic offers protection to damageable elements in the overcurrent range; it also provides the best protection to cables and lines.

Applications: commercial and industrial.

Standard: IEC/EN 60947-2, UL 489, CSA 22.2 No. 5



Number of poles	Rated current	Order details	Bbn 4016779	Price 1 piece	Price group	Weight 1 piece	Pack unit
In A	Type code	Order code	EAN			kg	pc.
1	0.2	S 201 U-K 0.2	2CDS 271 417 R0087	619226		0.14	10
	0.3	S 201 U-K 0.3	2CDS 271 417 R0117	619233		0.14	10
	0.5	S 201 U-K 0.5	2CDS 271 417 R0157	619240		0.14	10
	0.75	S 201 U-K 0.75	2CDS 271 417 R0187	619257		0.14	10
	1	S 201 U-K 1	2CDS 271 417 R0217	619264		0.14	10
	1.6	S 201 U-K 1.6	2CDS 271 417 R0257	619271		0.14	10
	2	S 201 U-K 2	2CDS 271 417 R0277	619288		0.14	10
	3	S 201 U-K 3	2CDS 271 417 R0317	619295		0.14	10
	4	S 201 U-K 4	2CDS 271 417 R0337	619301		0.14	10
	5	S 201 U-K 5	2CDS 271 417 R0357	619318		0.14	10
	6	S 201 U-K 6	2CDS 271 417 R0377	619325		0.14	10
	8	S 201 U-K 8	2CDS 271 417 R0407	619332		0.14	10
	10	S 201 U-K 10	2CDS 271 417 R0427	619349		0.14	10
	13	S 201 U-K 13	2CDS 271 417 R0447	619356		0.14	10
	15	S 201 U-K 15	2CDS 271 417 R0457	619363		0.14	10
	16	S 201 U-K 16	2CDS 271 417 R0467	619370		0.14	10
	20	S 201 U-K 20	2CDS 271 417 R0487	619387		0.14	10
	25	S 201 U-K 25	2CDS 271 417 R0517	619394		0.14	10
	30	S 201 U-K 30	2CDS 271 417 R0527	619400		0.14	10
	32	S 201 U-K 32	2CDS 271 417 R0537	619417		0.14	10
40	S 201 U-K 40	2CDS 271 417 R0557	619424		0.14	10	
50	S 201 U-K 50	2CDS 271 417 R0577	619431		0.14	10	
60	S 201 U-K 60	2CDS 271 417 R0587	619448		0.14	10	
63	S 201 U-K 63	2CDS 271 417 R0607	619455		0.14	10	
2	0.2	S 202 U-K 0.2	2CDS 272 417 R0087	619462		0.28	5
	0.3	S 202 U-K 0.3	2CDS 272 417 R0117	619479		0.28	5
	0.5	S 202 U-K 0.5	2CDS 272 417 R0157	619486		0.28	5
	0.75	S 202 U-K 0.75	2CDS 272 417 R0187	619493		0.28	5
	1	S 202 U-K 1	2CDS 272 417 R0217	619509		0.28	5
	1.6	S 202 U-K 1.6	2CDS 272 417 R0257	619516		0.28	5
	2	S 202 U-K 2	2CDS 272 417 R0277	619523		0.28	5
	3	S 202 U-K 3	2CDS 272 417 R0317	619530		0.28	5
	4	S 202 U-K 4	2CDS 272 417 R0337	619547		0.28	5
	5	S 202 U-K 5	2CDS 272 417 R0357	619554		0.28	5
	6	S 202 U-K 6	2CDS 272 417 R0377	619561		0.28	5
	8	S 202 U-K 8	2CDS 272 417 R0407	619578		0.28	5
	10	S 202 U-K 10	2CDS 272 417 R0427	619585		0.28	5
	13	S 202 U-K 13	2CDS 272 417 R0447	619592		0.28	5
15	S 202 U-K 15	2CDS 272 417 R0457	619608		0.28	5	
16	S 202 U-K 16	2CDS 272 417 R0467	619615		0.28	5	
20	S 202 U-K 20	2CDS 272 417 R0487	619622		0.28	5	
25	S 202 U-K 25	2CDS 272 417 R0517	619639		0.28	5	
30	S 202 U-K 30	2CDS 272 417 R0527	619646		0.28	5	
32	S 202 U-K 32	2CDS 272 417 R0537	619653		0.28	5	

10000



40	S 202 U-K 40	2CDS 272 417 R0557	619660	0.28	5
50	S 202 U-K 50	2CDS 272 417 R0577	619677	0.28	5
60	S 202 U-K 60	2CDS 272 417 R0587	619684	0.28	5
63	S 202 U-K 63	2CDS 272 417 R0607	619691	0.28	5
3	0.2 S 203 U-K 0.2	2CDS 273 417 R0087	619707	0.42	3
	0.3 S 203 U-K 0.3	2CDS 273 417 R0117	619714	0.42	3
	0.5 S 203 U-K 0.5	2CDS 273 417 R0157	619721	0.42	3
	0.75 S 203 U-K 0.75	2CDS 273 417 R0187	619738	0.42	3
	1 S 203 U-K 1	2CDS 273 417 R0217	619745	0.42	3
	1.6 S 203 U-K 1.6	2CDS 273 417 R0257	619752	0.42	3
	2 S 203 U-K 2	2CDS 273 417 R0277	619769	0.42	3
	3 S 203 U-K 3	2CDS 273 417 R0317	619776	0.42	3
	4 S 203 U-K 4	2CDS 273 417 R0337	619783	0.42	3
	5 S 203 U-K 5	2CDS 273 417 R0357	619790	0.42	3
	6 S 203 U-K 6	2CDS 273 417 R0377	619806	0.42	3
	8 S 203 U-K 8	2CDS 273 417 R0407	619813	0.42	3
	10 S 203 U-K 10	2CDS 273 417 R0427	619820	0.42	3
	13 S 203 U-K 13	2CDS 273 417 R0447	619837	0.42	3
	15 S 203 U-K 15	2CDS 273 417 R0457	619844	0.42	3
	16 S 203 U-K 16	2CDS 273 417 R0467	619851	0.42	3
	20 S 203 U-K 20	2CDS 273 417 R0487	619868	0.42	3
	25 S 203 U-K 25	2CDS 273 417 R0517	619875	0.42	3
	30 S 203 U-K 30	2CDS 273 417 R0527	619882	0.42	3
	32 S 203 U-K 32	2CDS 273 417 R0537	619899	0.42	3
	40 S 203 U-K 40	2CDS 273 417 R0557	619905	0.42	3
	50 S 203 U-K 50	2CDS 273 417 R0577	619912	0.42	3
	60 S 203 U-K 60	2CDS 273 417 R0587	619929	0.42	3
	63 S 203 U-K 63	2CDS 273 417 R0607	619936	0.42	3
4	0.2 S 204 U-K 0.2	2CDS 274 417 R0087	619943	0.56	2
	0.3 S 204 U-K 0.3	2CDS 274 417 R0117	619479	0.56	2
	0.5 S 204 U-K 0.5	2CDS 274 417 R0157	619967	0.56	2
	0.75 S 204 U-K 0.75	2CDS 274 417 R0187	619974	0.56	2
	1 S 204 U-K 1	2CDS 274 417 R0217	619509	0.56	2
	1.6 S 204 U-K 1.6	2CDS 274 417 R0257	619998	0.56	2
	2 S 204 U-K 2	2CDS 274 417 R0277	620000	0.56	2
	3 S 204 U-K 3	2CDS 274 417 R0317	620017	0.56	2
	4 S 204 U-K 4	2CDS 274 417 R0337	620024	0.56	2
	5 S 204 U-K 5	2CDS 274 417 R0357	620031	0.56	2
	6 S 204 U-K 6	2CDS 274 417 R0377	620048	0.56	2
	8 S 204 U-K 8	2CDS 274 417 R0407	620055	0.56	2
	10 S 204 U-K 10	2CDS 274 417 R0427	620062	0.56	2
	13 S 204 U-K 13	2CDS 274 417 R0447	620079	0.56	2
	15 S 204 U-K 15	2CDS 274 417 R0457	620086	0.56	2
	16 S 204 U-K 16	2CDS 274 417 R0467	620093	0.56	2
	20 S 204 U-K 20	2CDS 274 417 R0487	620109	0.56	2
	25 S 204 U-K 25	2CDS 274 417 R0517	620116	0.56	2
	30 S 204 U-K 30	2CDS 274 417 R0527	620123	0.56	2
	32 S 204 U-K 32	2CDS 274 417 R0537	620130	0.56	2
	40 S 204 U-K 40	2CDS 274 417 R0557	620147	0.56	2
	50 S 204 U-K 50	2CDS 274 417 R0577	620154	0.56	2
	60 S 204 U-K 60	2CDS 274 417 R0587	620161	0.56	2
	63 S 204 U-K 63	2CDS 274 417 R0607	620178	0.56	2

2

10000

Z



2CSC400014F0201



2CSC400015F0201



S 200 U-Z characteristic

Function: protection and control of the electronic circuits against weak and long duration overloads and short-circuits.

Applications: commercial and industrial.

Standard: IEC/EN 60947-2, UL 489, CSA 22.2 No. 5

Number of poles	Rated current	Order details	Bbn 4016779	Price 1 piece	Price group	Weight 1 piece	Pack unit
In A	Type code	Order code	EAN		kg	pc.	
1	0.5	S 201 U-Z 0.5	2CDS 271 417 R0158	620185		0.14	10
	1	S 201 U-Z 1	2CDS 271 417 R0218	620192		0.14	10
	1.6	S 201 U-Z 1.6	2CDS 271 417 R0258	620208		0.14	10
	2	S 201 U-Z 2	2CDS 271 417 R0278	620215		0.14	10
	3	S 201 U-Z 3	2CDS 271 417 R0318	620222		0.14	10
	4	S 201 U-Z 4	2CDS 271 417 R0338	620239		0.14	10
	5	S 201 U-Z 5	2CDS 271 417 R0358	620246		0.14	10
	6	S 201 U-Z 6	2CDS 271 417 R0378	620253		0.14	10
	8	S 201 U-Z 8	2CDS 271 417 R0408	620260		0.14	10
	10	S 201 U-Z 10	2CDS 271 417 R0428	620277		0.14	10
	15	S 201 U-Z 15	2CDS 271 417 R0458	620291		0.14	10
	16	S 201 U-Z 16	2CDS 271 417 R0468	620307		0.14	10
	20	S 201 U-Z 20	2CDS 271 417 R0488	620314		0.14	10
	25	S 201 U-Z 25	2CDS 271 417 R0518	620321		0.14	10
	30	S 201 U-Z 30	2CDS 271 417 R0528	622851		0.14	10
32	S 201 U-Z 32	2CDS 271 417 R0538	620345		0.14	10	
40	S 201 U-Z 40	2CDS 271 417 R0558	620352		0.14	10	
50	S 201 U-Z 50	2CDS 271 417 R0578	620369		0.14	10	
60	S 201 U-Z 60	2CDS 271 417 R0588	620376		0.14	10	
63	S 201 U-Z 63	2CDS 271 417 R0608	620383		0.14	10	
2	0.5	S 202 U-Z 0.5	2CDS 272 417 R0158	620390		0.28	5
	1	S 202 U-Z 1	2CDS 272 417 R0218	620406		0.28	5
	1.6	S 202 U-Z 1.6	2CDS 272 417 R0258	620413		0.28	5
	2	S 202 U-Z 2	2CDS 272 417 R0278	620420		0.28	5
	3	S 202 U-Z 3	2CDS 272 417 R0318	620437		0.28	5
	4	S 202 U-Z 4	2CDS 272 417 R0338	620444		0.28	5
	5	S 202 U-Z 5	2CDS 272 417 R0358	620451		0.28	5
	6	S 202 U-Z 6	2CDS 272 417 R0378	620468		0.28	5
	8	S 202 U-Z 8	2CDS 272 417 R0408	620475		0.28	5
	10	S 202 U-Z 10	2CDS 272 417 R0428	620482		0.28	5
	15	S 202 U-Z 15	2CDS 272 417 R0458	620505		0.28	5
	16	S 202 U-Z 16	2CDS 272 417 R0468	620512		0.28	5
	20	S 202 U-Z 20	2CDS 272 417 R0488	620529		0.28	5
	25	S 202 U-Z 25	2CDS 272 417 R0518	620536		0.28	5
	30	S 202 U-Z 30	2CDS 272 417 R0528	620543		0.28	5
32	S 202 U-Z 32	2CDS 272 417 R0538	620550		0.28	5	
40	S 202 U-Z 40	2CDS 272 417 R0558	620567		0.28	5	
50	S 202 U-Z 50	2CDS 272 417 R0578	620574		0.28	5	
60	S 202 U-Z 60	2CDS 272 417 R0588	620581		0.28	5	
63	S 202 U-Z 63	2CDS 272 417 R0608	620598		0.28	5	



3	0.5	S 203 U-Z 0.5	2CDS 273 417 R0158	620604	0.42	3
	1	S 203 U-Z 1	2CDS 273 417 R0218	620611	0.42	3
	1.6	S 203 U-Z 1.6	2CDS 273 417 R0258	620628	0.42	3
	2	S 203 U-Z 2	2CDS 273 417 R0278	620635	0.42	3
	3	S 203 U-Z 3	2CDS 273 417 R0318	620624	0.42	3
	4	S 203 U-Z 4	2CDS 273 417 R0338	620659	0.42	3
	5	S 203 U-Z 5	2CDS 273 417 R0358	620666	0.42	3
	6	S 203 U-Z 6	2CDS 273 417 R0378	620673	0.42	3
	8	S 203 U-Z 8	2CDS 273 417 R0408	620680	0.42	3
	10	S 203 U-Z 10	2CDS 273 417 R0428	620697	0.42	3
	15	S 203 U-Z 15	2CDS 273 417 R0458	620710	0.42	3
	16	S 203 U-Z 16	2CDS 273 417 R0468	620727	0.42	3
	20	S 203 U-Z 20	2CDS 273 417 R0488	620734	0.42	3
	25	S 203 U-Z 25	2CDS 273 417 R0518	620741	0.42	3
	30	S 203 U-Z 30	2CDS 273 417 R0528	620758	0.42	3
	32	S 203 U-Z 32	2CDS 273 417 R0538	620765	0.42	3
	40	S 203 U-Z 40	2CDS 273 417 R0558	620772	0.42	3
50	S 203 U-Z 50	2CDS 273 417 R0578	620789	0.42	3	
60	S 203 U-Z 60	2CDS 273 417 R0588	620796	0.42	3	
63	S 203 U-Z 63	2CDS 273 417 R0608	620802	0.42	3	
4	0.5	S 204 U-Z 0.5	2CDS 274 417 R0158	620819	0.56	2
	1	S 204 U-Z 1	2CDS 274 417 R0218	620826	0.56	2
	1.6	S 204 U-Z 1.6	2CDS 274 417 R0258	620833	0.56	2
	2	S 204 U-Z 2	2CDS 274 417 R0278	620840	0.56	2
	3	S 204 U-Z 3	2CDS 274 417 R0318	620857	0.56	2
	4	S 204 U-Z 4	2CDS 274 417 R0338	620864	0.56	2
	5	S 204 U-Z 5	2CDS 274 417 R0358	620871	0.56	2
	6	S 204 U-Z 6	2CDS 274 417 R0378	620888	0.56	2
	8	S 204 U-Z 8	2CDS 274 417 R0408	620895	0.56	2
	10	S 204 U-Z 10	2CDS 274 417 R0428	620901	0.56	2
	15	S 204 U-Z 15	2CDS 274 417 R0458	620925	0.56	2
	16	S 204 U-Z 16	2CDS 274 417 R0468	620932	0.56	2
	20	S 204 U-Z 20	2CDS 274 417 R0488	620949	0.56	2
	25	S 204 U-Z 25	2CDS 274 417 R0518	620956	0.56	2
	30	S 204 U-Z 30	2CDS 274 417 R0528	620963	0.56	2
	32	S 204 U-Z 32	2CDS 274 417 R0538	620970	0.56	2
	40	S 204 U-Z 40	2CDS 274 417 R0558	620987	0.56	2
50	S 204 U-Z 50	2CDS 274 417 R0578	620994	0.56	2	
60	S 204 U-Z 60	2CDS 274 417 R0588	621007	0.56	2	
63	S 204 U-Z 63	2CDS 274 417 R0608	621014	0.56	2	

K

S 200 UP-K characteristic

Function: protection and control of the circuits like motors, transformers and auxiliary circuits, against overloads and short-circuits.

Advantages: no nuisance tripping in the case of functional peak currents up to 10xI_n, depending on the series; through its highly sensitive thermostatic bimetal trip, the K-type characteristic offers protection to damageable elements in the overcurrent range; it also provides the best protection to cables and lines.

Applications: commercial and industrial.

Standard: IEC/EN 60947-2, UL 489, CSA 22.2 No. 5



2CSC400018F0201



2CSC400019F0201



Number of poles	Rated current	Order details	Bbn 4016779	Price 1 piece	Price group	Weight 1 piece	Pack unit
In A	Type code	Order code	EAN			kg	pc.
1	0.2	S 201 UP-K 0.2	2CDS 271 317 R0087	615631		0.14	10
	0.3	S 201 UP-K 0.3	2CDS 271 317 R0117	615648		0.14	10
	0.5	S 201 UP-K 0.5	2CDS 271 317 R0157	615655		0.14	10
	0.75	S 201 UP-K 0.75	2CDS 271 317 R0187	615662		0.14	10
	1	S 201 UP-K 1	2CDS 271 317 R0217	615679		0.14	10
	1.6	S 201 UP-K 1.6	2CDS 271 317 R0257	615686		0.14	10
	2	S 201 UP-K 2	2CDS 271 317 R0277	615693		0.14	10
	3	S 201 UP-K 3	2CDS 271 317 R0317	615709		0.14	10
	4	S 201 UP-K 4	2CDS 271 317 R0337	615716		0.14	10
	5	S 201 UP-K 5	2CDS 271 317 R0357	615723		0.14	10
	6	S 201 UP-K 6	2CDS 271 317 R0377	615730		0.14	10
	8	S 201 UP-K 8	2CDS 271 317 R0407	615747		0.14	10
	10	S 201 UP-K 10	2CDS 271 317 R0427	615754		0.14	10
	13	S 201 UP-K 13	2CDS 271 317 R0447	615761		0.14	10
	15	S 201 UP-K 15	2CDS 271 317 R0457	615778		0.14	10
16	S 201 UP-K 16	2CDS 271 317 R0467	615785		0.14	10	
20	S 201 UP-K 20	2CDS 271 317 R0487	615792		0.14	10	
25	S 201 UP-K 25	2CDS 271 317 R0517	615808		0.14	10	
2	0.2	S 202 UP-K 0.2	2CDS 272 317 R0087	615877		0.28	5
	0.3	S 202 UP-K 0.3	2CDS 272 317 R0117	615884		0.28	5
	0.5	S 202 UP-K 0.5	2CDS 272 317 R0157	615891		0.28	5
	0.75	S 202 UP-K 0.75	2CDS 272 317 R0187	615907		0.28	5
	1	S 202 UP-K 1	2CDS 272 317 R0217	615914		0.28	5
	1.6	S 202 UP-K 1.6	2CDS 272 317 R0257	615921		0.28	5
	2	S 202 UP-K 2	2CDS 272 317 R0277	615938		0.28	5
	3	S 202 UP-K 3	2CDS 272 317 R0317	615945		0.28	5
	4	S 202 UP-K 4	2CDS 272 317 R0337	615952		0.28	5
	5	S 202 UP-K 5	2CDS 272 317 R0357	615969		0.28	5
	6	S 202 UP-K 6	2CDS 272 317 R0377	615976		0.28	5
	8	S 202 UP-K 8	2CDS 272 317 R0407	615983		0.28	5
	10	S 202 UP-K 10	2CDS 272 317 R0427	615990		0.28	5
	13	S 202 UP-K 13	2CDS 272 317 R0447	616003		0.28	5
	15	S 202 UP-K 15	2CDS 272 317 R0457	616010		0.28	5
16	S 202 UP-K 16	2CDS 272 317 R0467	616027		0.28	5	
20	S 202 UP-K 20	2CDS 272 317 R0487	616034		0.28	5	
25	S 202 UP-K 25	2CDS 272 317 R0517	616041		0.28	5	

10000

2

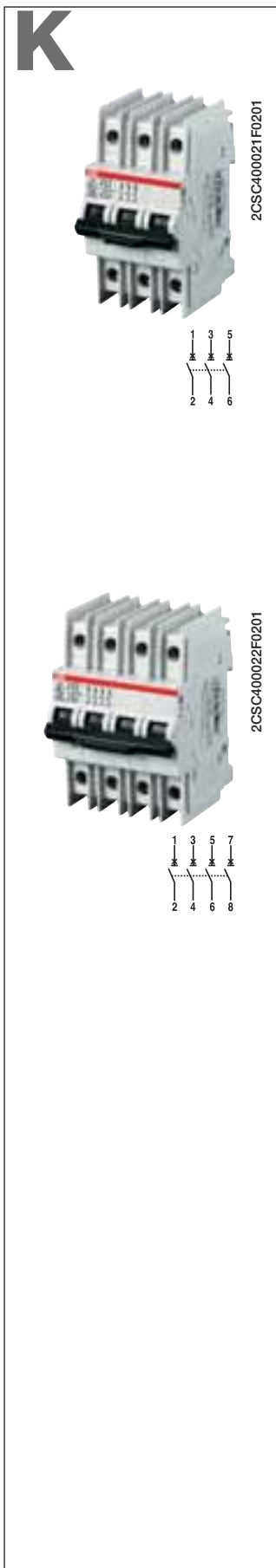

3	0.2	S 203 UP-K	0.2	2CDS 273 317 R0087	616119	0.42	3
	0.3	S 203 UP-K	0.3	2CDS 273 317 R0117	616126	0.42	3
	0.5	S 203 UP-K	0.5	2CDS 273 317 R0157	616133	0.42	3
	0.75	S 203 UP-K	0.75	2CDS 273 317 R0187	616140	0.42	3
	1	S 203 UP-K	1	2CDS 273 317 R0217	616157	0.42	3
	1.6	S 203 UP-K	1.6	2CDS 273 317 R0257	616164	0.42	3
	2	S 203 UP-K	2	2CDS 273 317 R0277	616171	0.42	3
	3	S 203 UP-K	3	2CDS 273 317 R0317	616188	0.42	3
	4	S 203 UP-K	4	2CDS 273 317 R0337	616195	0.42	3
	5	S 203 UP-K	5	2CDS 273 317 R0357	616201	0.42	3
	6	S 203 UP-K	6	2CDS 273 317 R0377	616218	0.42	3
	8	S 203 UP-K	8	2CDS 273 317 R0407	616225	0.42	3
	10	S 203 UP-K	10	2CDS 273 317 R0427	616232	0.42	3
	13	S 203 UP-K	13	2CDS 273 317 R0447	616249	0.42	3
	15	S 203 UP-K	15	2CDS 273 317 R0457	616256	0.42	3
	16	S 203 UP-K	16	2CDS 273 317 R0467	616263	0.42	3
20	S 203 UP-K	20	2CDS 273 317 R0487	616270	0.42	3	
25	S 203 UP-K	25	2CDS 273 317 R0517	616287	0.42	3	

4	0.2	S 204 UP-K	0.2	2CDS 274 317 R0087	616355	0.56	2
	0.3	S 204 UP-K	0.3	2CDS 274 317 R0117	616362	0.56	2
	0.5	S 204 UP-K	0.5	2CDS 274 317 R0157	616379	0.56	2
	0.75	S 204 UP-K	0.75	2CDS 274 317 R0187	616386	0.56	2
	1	S 204 UP-K	1	2CDS 274 317 R0217	616393	0.56	2
	1.6	S 204 UP-K	1.6	2CDS 274 317 R0257	616409	0.56	2
	2	S 204 UP-K	2	2CDS 274 317 R0277	616416	0.56	2
	3	S 204 UP-K	3	2CDS 274 317 R0317	616423	0.56	2
	4	S 204 UP-K	4	2CDS 274 317 R0337	616430	0.56	2
	5	S 204 UP-K	5	2CDS 274 317 R0357	616447	0.56	2
	6	S 204 UP-K	6	2CDS 274 317 R0377	616454	0.56	2
	8	S 204 UP-K	8	2CDS 274 317 R0407	616461	0.56	2
	10	S 204 UP-K	10	2CDS 274 317 R0427	616478	0.56	2
	13	S 204 UP-K	13	2CDS 274 317 R0447	616485	0.56	2
	15	S 204 UP-K	15	2CDS 274 317 R0457	616492	0.56	2
	16	S 204 UP-K	16	2CDS 274 317 R0467	616508	0.56	2
20	S 204 UP-K	20	2CDS 274 317 R0487	616515	0.56	2	
25	S 204 UP-K	25	2CDS 274 317 R0517	616522	0.56	2	

10000

Z

2



2CSC400018F0201



2CSC400019F0201



S 200 UP-Z characteristic

Function: protection and control of the electronic circuits against weak and long duration overloads and short-circuits.

Applications: commercial and industrial.

Standard: IEC/EN 60947-2, UL 489, CSA 22.2 No. 5

Number of poles	Rated current	Order details	Bbn 4016779	Price 1 piece	Price group	Weight 1 piece	Pack unit
In A	Type code	Order code	EAN			kg	pc.
1	0.5	S 201 UP-Z 0.5	2CDS 271 317 R0158	616591		0.14	10
	1	S 201 UP-Z 1	2CDS 271 317 R0218	616607		0.14	10
	1.6	S 201 UP-Z 1.6	2CDS 271 317 R0258	616614		0.14	10
	2	S 201 UP-Z 2	2CDS 271 317 R0278	616621		0.14	10
	3	S 201 UP-Z 3	2CDS 271 317 R0318	616638		0.14	10
	4	S 201 UP-Z 4	2CDS 271 317 R0338	616645		0.14	10
	5	S 201 UP-Z 5	2CDS 271 317 R0358	616652		0.14	10
	6	S 201 UP-Z 6	2CDS 271 317 R0378	616669		0.14	10
	8	S 201 UP-Z 8	2CDS 271 317 R0408	616676		0.14	10
	10	S 201 UP-Z 10	2CDS 271 317 R0428	616683		0.14	10
	13	S 201 UP-Z 13	2CDS 271 317 R0448	616690		0.14	10
	15	S 201 UP-Z 15	2CDS 271 317 R0458	616706		0.14	10
	16	S 201 UP-Z 16	2CDS 271 317 R0468	616713		0.14	10
20	S 201 UP-Z 20	2CDS 271 317 R0488	616720		0.14	10	
25	S 201 UP-Z 25	2CDS 271 317 R0518	616737		0.14	10	
2	0.5	S 202 UP-Z 0.5	2CDS 272 317 R0158	616805		0.28	5
	1	S 202 UP-Z 1	2CDS 272 317 R0218	616812		0.28	5
	1.6	S 202 UP-Z 1.6	2CDS 272 317 R0258	616829		0.28	5
	2	S 202 UP-Z 2	2CDS 272 317 R0278	616836		0.28	5
	3	S 202 UP-Z 3	2CDS 272 317 R0318	616843		0.28	5
	4	S 202 UP-Z 4	2CDS 272 317 R0338	616850		0.28	5
	5	S 202 UP-Z 5	2CDS 272 317 R0358	616867		0.28	5
	6	S 202 UP-Z 6	2CDS 272 317 R0378	616874		0.28	5
	8	S 202 UP-Z 8	2CDS 272 317 R0408	616881		0.28	5
	10	S 202 UP-Z 10	2CDS 272 317 R0428	616898		0.28	5
	13	S 202 UP-Z 13	2CDS 272 317 R0448	616904		0.28	5
	15	S 202 UP-Z 15	2CDS 272 317 R0458	616911		0.28	5
	16	S 202 UP-Z 16	2CDS 272 317 R0468	616928		0.28	5
20	S 202 UP-Z 20	2CDS 272 317 R0488	616935		0.28	5	
25	S 202 UP-Z 25	2CDS 272 317 R0518	616942		0.28	5	

10000

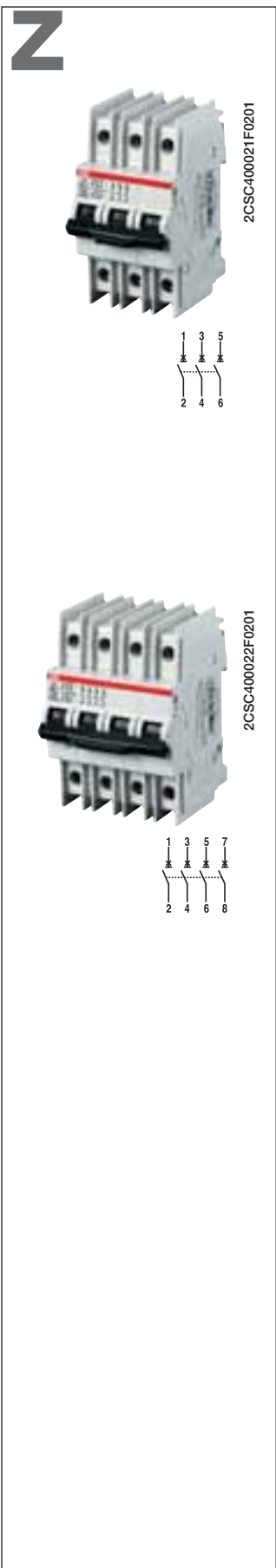

3	0.5	S 203 UP-Z 0.5	2CDS 273 317 R0158	617017	0.42	3
	1	S 203 UP-Z 1	2CDS 273 317 R0218	617024	0.42	3
	1.6	S 203 UP-Z 1.6	2CDS 273 317 R0258	617031	0.42	3
	2	S 203 UP-Z 2	2CDS 273 317 R0278	617048	0.42	3
	3	S 203 UP-Z 3	2CDS 273 317 R0318	617055	0.42	3
	4	S 203 UP-Z 4	2CDS 273 317 R0338	617062	0.42	3
	5	S 203 UP-Z 5	2CDS 273 317 R0358	617079	0.42	3
	6	S 203 UP-Z 6	2CDS 273 317 R0378	617086	0.42	3
	8	S 203 UP-Z 8	2CDS 273 317 R0408	617093	0.42	3
	10	S 203 UP-Z 10	2CDS 273 317 R0428	617109	0.42	3
	13	S 203 UP-Z 13	2CDS 273 317 R0448	617116	0.42	3
	15	S 203 UP-Z 15	2CDS 273 317 R0458	617123	0.42	3
	16	S 203 UP-Z 16	2CDS 273 317 R0468	617130	0.42	3
20	S 203 UP-Z 20	2CDS 273 317 R0488	617147	0.42	3	
25	S 203 UP-Z 25	2CDS 273 317 R0518	617154	0.42	3	
4	0.5	S 204 UP-Z 0.5	2CDS 274 317 R0158	617222	0.56	2
	1	S 204 UP-Z 1	2CDS 274 317 R0218	617239	0.56	2
	1.6	S 204 UP-Z 1.6	2CDS 274 317 R0258	617246	0.56	2
	2	S 204 UP-Z 2	2CDS 274 317 R0278	617253	0.56	2
	3	S 204 UP-Z 3	2CDS 274 317 R0318	617260	0.56	2
	4	S 204 UP-Z 4	2CDS 274 317 R0338	617277	0.56	2
	5	S 204 UP-Z 5	2CDS 274 317 R0358	617284	0.56	2
	6	S 204 UP-Z 6	2CDS 274 317 R0378	617291	0.56	2
	8	S 204 UP-Z 8	2CDS 274 317 R0408	617307	0.56	2
	10	S 204 UP-Z 10	2CDS 274 317 R0428	617314	0.56	2
	13	S 204 UP-Z 13	2CDS 274 317 R0448	617321	0.56	2
	15	S 204 UP-Z 15	2CDS 274 317 R0458	617338	0.56	2
	16	S 204 UP-Z 16	2CDS 274 317 R0468	617345	0.56	2
20	S 204 UP-Z 20	2CDS 274 317 R0488	617352	0.56	2	
25	S 204 UP-Z 25	2CDS 274 317 R0518	617369	0.56	2	

K

2



S 200 UDC-K characteristic

Function: protection and control of the circuits like motors, transformers and auxiliary circuits, against overloads and short-circuits.

Advantages: no nuisance tripping in the case of functional peak currents up to 10xI_n, depending on the series; through its highly sensitive thermostatic bimetal trip, the K-type characteristic offers protection to damageable elements in the overcurrent range; it also provides the best protection to cables and lines.

Applications: commercial and industrial.

Standard: UL 489 (only DC, please note polarity of device)

Number of poles	Rated current	Order details	Bbn 4016779	Price 1 piece	Price group	Weight 1 piece	Pack unit
In A	Type code	Order code	EAN	kg	pc.		
1	1	S 201 UDC-K 1	2CDS 271 517 R0217	825924		0.150	10
	1,6	S 201 UDC-K 1.6	2CDS 271 517 R0257	825948		0.150	10
	2	S 201 UDC-K 2	2CDS 271 517 R0277	825955		0.150	10
	3	S 201 UDC-K 3	2CDS 271 517 R0317	825962		0.150	10
	4	S 201 UDC-K 4	2CDS 271 517 R0337	825979		0.150	10
	5	S 201 UDC-K 5	2CDS 271 517 R0357	825986		0.150	10
	6	S 201 UDC-K 6	2CDS 271 517 R0377	825993		0.150	10
	8	S 201 UDC-K 8	2CDS 271 517 R0407	826006		0.150	10
	10	S 201 UDC-K 10	2CDS 271 517 R0427	826013		0.150	10
	13	S 201 UDC-K 13	2CDS 271 517 R0447	826020		0.150	10
	15	S 201 UDC-K 15	2CDS 271 517 R0457	826037		0.150	10
	16	S 201 UDC-K 16	2CDS 271 517 R0467	826044		0.150	10
	20	S 201 UDC-K 20	2CDS 271 517 R0487	826051		0.150	10
	25	S 201 UDC-K 25	2CDS 271 517 R0517	826068		0.150	10
	30	S 201 UDC-K 30	2CDS 271 517 R0527	826075		0.150	10
	32	S 201 UDC-K 32	2CDS 271 517 R0537	826082		0.150	10
	40	S 201 UDC-K 40	2CDS 271 517 R0557	826099		0.150	10
50	S 201 UDC-K 50	2CDS 271 517 R0577	826105		0.150	10	
60	S 201 UDC-K 60	2CDS 271 517 R0587	826112		0.150	10	
63	S 201 UDC-K 63	2CDS 271 517 R0607	826129		0.150	10	
2	1	S 202 UDC-K 1	2CDS 272 517 R0217	825061		0.300	5
	1,6	S 202 UDC-K 1.6	2CDS 272 517 R0257	825160		0.300	5
	2	S 202 UDC-K 2	2CDS 272 517 R0277	825177		0.300	5
	3	S 202 UDC-K 3	2CDS 272 517 R0317	825184		0.300	5
	4	S 202 UDC-K 4	2CDS 272 517 R0337	825191		0.300	5
	5	S 202 UDC-K 5	2CDS 272 517 R0357	825207		0.300	5
	6	S 202 UDC-K 6	2CDS 272 517 R0377	825214		0.300	5
	8	S 202 UDC-K 8	2CDS 272 517 R0407	825221		0.300	5
	10	S 202 UDC-K 10	2CDS 272 517 R0427	825238		0.300	5
	13	S 202 UDC-K 13	2CDS 272 517 R0447	825245		0.300	5
	15	S 202 UDC-K 15	2CDS 272 517 R0457	825252		0.300	5
	16	S 202 UDC-K 16	2CDS 272 517 R0467	825269		0.300	5
	20	S 202 UDC-K 20	2CDS 272 517 R0487	825276		0.300	5
	25	S 202 UDC-K 25	2CDS 272 517 R0517	825283		0.300	5
	30	S 202 UDC-K 30	2CDS 272 517 R0527	825290		0.300	5
	32	S 202 UDC-K 32	2CDS 272 517 R0537	825306		0.300	5
	40	S 202 UDC-K 40	2CDS 272 517 R0557	825313		0.300	5
50	S 202 UDC-K 50	2CDS 272 517 R0577	825320		0.300	5	
60	S 202 UDC-K 60	2CDS 272 517 R0587	825337		0.300	5	
63	S 202 UDC-K 63	2CDS 272 517 R0607	825344		0.300	5	

Z



S 200 UDC-Z characteristic

Function: protection and control of the electronic circuits against weak and long duration overloads and short-circuits.

Applications: commercial and industrial.

Standard: UL 489 (only DC, please note polarity of device)

Number of poles	Rated current	Order details	Bbn 4016779	Price 1 piece	Price group	Weight 1 piece	Pack unit
In A	Type code	Order code	EAN			kg	pc.
1	1	S 201 UDC-Z 1	2CDS 271 517 R0218	826136		0.150	10
	1,6	S 201 UDC-Z 1.6	2CDS 271 517 R0258	826143		0.150	10
	2	S 201 UDC-Z 2	2CDS 271 517 R0278	826150		0.150	10
	3	S 201 UDC-Z 3	2CDS 271 517 R0318	826167		0.150	10
	4	S 201 UDC-Z 4	2CDS 271 517 R0338	826174		0.150	10
	5	S 201 UDC-Z 5	2CDS 271 517 R0358	826181		0.150	10
	6	S 201 UDC-Z 6	2CDS 271 517 R0378	826198		0.150	10
	8	S 201 UDC-Z 8	2CDS 271 517 R0408	826204		0.150	10
	10	S 201 UDC-Z 10	2CDS 271 517 R0428	826211		0.150	10
	15	S 201 UDC-Z 15	2CDS 271 517 R0458	826228		0.150	10
	16	S 201 UDC-Z 16	2CDS 271 517 R0468	826235		0.150	10
	20	S 201 UDC-Z 20	2CDS 271 517 R0488	826242		0.150	10
	25	S 201 UDC-Z 25	2CDS 271 517 R0518	826259		0.150	10
	30	S 201 UDC-Z 30	2CDS 271 517 R0528	826266		0.150	10
	32	S 201 UDC-Z 32	2CDS 271 517 R0538	826273		0.150	10
	40	S 201 UDC-Z 40	2CDS 271 517 R0558	826280		0.150	10
	50	S 201 UDC-Z 50	2CDS 271 517 R0578	826297		0.150	10
60	S 201 UDC-Z 60	2CDS 271 517 R0588	826303		0.150	10	
63	S 201 UDC-Z 63	2CDS 271 517 R0608	826310		0.150	10	
2	1	S 202 UDC-Z 1	2CDS 272 517 R0218	825351		0.300	5
	1,6	S 202 UDC-Z 1.6	2CDS 272 517 R0258	825368		0.300	5
	2	S 202 UDC-Z 2	2CDS 272 517 R0278	825375		0.300	5
	3	S 202 UDC-Z 3	2CDS 272 517 R0318	825382		0.300	5
	4	S 202 UDC-Z 4	2CDS 272 517 R0338	825399		0.300	5
	5	S 202 UDC-Z 5	2CDS 272 517 R0358	825405		0.300	5
	6	S 202 UDC-Z 6	2CDS 272 517 R0378	825412		0.300	5
	8	S 202 UDC-Z 8	2CDS 272 517 R0408	825429		0.300	5
	10	S 202 UDC-Z 10	2CDS 272 517 R0428	825436		0.300	5
	15	S 202 UDC-Z 15	2CDS 272 517 R0458	825443		0.300	5
	16	S 202 UDC-Z 16	2CDS 272 517 R0468	825450		0.300	5
	20	S 202 UDC-Z 20	2CDS 272 517 R0488	825467		0.300	5
	25	S 202 UDC-Z 25	2CDS 272 517 R0518	825474		0.300	5
	30	S 202 UDC-Z 30	2CDS 272 517 R0528	825481		0.300	5
	32	S 202 UDC-Z 32	2CDS 272 517 R0538	825498		0.300	5
	40	S 202 UDC-Z 40	2CDS 272 517 R0558	825504		0.300	5
	50	S 202 UDC-Z 50	2CDS 272 517 R0578	825511		0.300	5
60	S 202 UDC-Z 60	2CDS 272 517 R0588	825528		0.300	5	
63	S 202 UDC-Z 63	2CDS 272 517 R0608	825535		0.300	5	



2CSC400133F0201



2CSC400129F0201



2CSC400005F0201

The SN 201 range of circuit-breakers is the new ABB range of 1P+N single-module MCBs.

These circuit-breakers are available with rated currents from 2 to 40 A, in the version with C characteristic, and with rated currents from 6 to 40 A, in the version with B and D characteristics.

For each current there are also three different breaking capacities available: 4.5 kA (SN 201 L series), 6 kA (SN 201 series) and 10 kA (SN 201 M series).

The circuit-breakers have been designed to ensure, in the final closing section, that the closing speed of the contacts is independent of the speed at which the knob rotated.

The trip mechanism (ABB international patent) ensures perfect closure every time, thereby considerably improving the performance of these devices and extending

their average lifetime.

A redesigned red/green toggle makes the ON/OFF status immediately apparent.

With the practical label carrier fitted in the new SN 201 circuit-breakers it's possible

to give maximum visibility to the information relating to the protected loads.

The larger neutral hole allows the use of an insulated screwdriver to tighten the screws of both wire terminals,

ensuring maximum safety of the operation.

Due to larger size of the DIN rail fixing system, made with 2 bistable fixing devices, the same screwdriver used for tightening the terminals can also be used for assembling and disassembling the device.



2CSC400134F0201

All versions are equipped with high capacity cage type terminals (16 mm²).

The SN 201 range circuit breakers have been designed for wiring with the ABB SACE Unifix rapid system.

The SN 201 fully integrates with the range of System pro M compact[®] miniature circuit-breakers, sharing the wide selection of accessories available through a dedicated interface (half module), which also can be used as auxiliary contact.



Index

Technical features of MCBs SN 201 series	2/50
Selection tables of MCBs SN 201 series	
SN 201 L-B	2/52
SN 201 L-C	2/52
SN 201-B	2/53
SN 201-C	2/53
SN 201-D	2/54
SN 201 M-B	2/55
SN 201 M-C	2/55

TECHNICAL FEATURES

Standards

Rated current I_n A

Poles

Rated voltage U_e V

Insulation voltage U_i V

Max. operating voltage U_b max. AC V

DC 1P V

DC 1P+N V

Min. operating voltage U_b min. V

Rated frequency Hz

Rated breaking capacity acc. to IEC/EN 60898 ultimate I_{cn} A

Rated making and breaking capacity of an individual pole I_{cn1} kA

Rated breaking capacity ultimate I_{cu} kA

acc. to IEC 947-2 1P+N - 230 V service I_{cs} kA

Rated impulse withstand voltage (1,2/50) U_{imp} kV

Dielectric test voltage at ind. freq. for 1 min. kV

Overvoltage category

Thermal-magnetic release characteristic B: $3 I_n \leq I_m \leq 5 I_n$

C: $5 I_n \leq I_m \leq 10 I_n$

D: $10 I_n \leq I_m \leq 20 I_n$

Toggle

Electrical life

Mechanical life

Protection degree housing terminals

Tropicalization humid heat °C/RH

acc. to IEC 68-2 constant climate conditions °C/RH

variable climate conditions °C/RH

Reference temperature for calibration of thermal element °C

Ambient temperature (with daily average $\leq +35^\circ\text{C}$) °C

Storage temperature °C

Terminal size upper/lower per cable mm²

Tightening torque N*m

Mounting

Pole dimensions (H x D x W) mm

Pole weight g



SN 201 L	SN 201	SN 201 M
	IEC/EN 60898	
	2 ≤ In ≤ 40 ①	
	1P+N	
	230	
	500	
	254	
	60	
	125	
	12VAC - 12VDC	
	50...60	
4500	6000	10000
4.5	6	6
6	10	10
4.5	6	7.5
	5	
	2.5	
	III	
■	■	■
■	■	■
	black sealable in ON-OFF position	
	10000	
	20000	
	IP4X	
	IP2X	
	28 cycles with 55/95...100	
	23/83 - 40/93 - 55/20	
	25/95 - 40/95	
	30	
	-25...+55	
	-40...+70	
	16/16	
	1,2	
	on DIN rail EN 60715 (35mm) by means of rapid fixing device	
	85 x 68.9 x 17.6	
	110	

① SN201 and SN201M series in B and D characteristic are available for rated current In ≥ 6 A

B



2CSC40066TF0002

SN 201 L - B characteristic

Function: overload and short-circuit protection of circuits in final distribution; protection of long cable lengths in TN and IT systems.

Applications: residential.

Standard: IEC/EN 60898

Icn: 4.5 kA

Number of poles	Rated current In A	Order details		Bbn 8012542 EAN	Price 1 piece	Price group	Weight 1 piece kg	Pack unit pc.
		Type	Order code					
1+N	2	SN201 L B2	2CSS245101R0025	087366			0.110	6
	4	SN201 L B4	2CSS245101R0045	087465			0.110	6
	6	SN201 L B6	2CSS245101R0065	087564			0.110	6
	10	SN201 L B10	2CSS245101R0105	087663			0.110	6
	16	SN201 L B16	2CSS245101R0165	087762			0.110	6
	20	SN201 L B20	2CSS245101R0205	087861			0.110	6
	25	SN201 L B25	2CSS245101R0255	087960			0.110	6
	32	SN201 L B32	2CSS245101R0325	088066			0.110	6
	40	SN201 L B40	2CSS245101R0405	088165			0.110	6

C



2CSC400666F0001

SN 201 L - C characteristic

Function: overload and short-circuit protection of circuits in final distribution; protection of resistive and inductive loads with low inrush current.

Applications: residential.

Standard: IEC/EN 60898

Icn: 4.5 kA

Number of poles	Rated current In A	Order details		Bbn 8012542 EAN	Price 1 piece	Price group	Weight 1 piece kg	Pack unit pc.
		Type	Order code					
1+N	2	SN201 L C2	2CSS245101R0024	088264			0.110	6
	4	SN201 L C4	2CSS245101R0044	088363			0.110	6
	6	SN201 L C6	2CSS245101R0064	088462			0.110	6
	10	SN201 L C10	2CSS245101R0104	088561			0.110	6
	16	SN201 L C16	2CSS245101R0164	088660			0.110	6
	20	SN201 L C20	2CSS245101R0204	088769			0.110	6
	25	SN201 L C25	2CSS245101R0254	088868			0.110	6
	32	SN201 L C32	2CSS245101R0324	088967			0.110	6
	40	SN201 L C40	2CSS245101R0404	089063			0.110	6

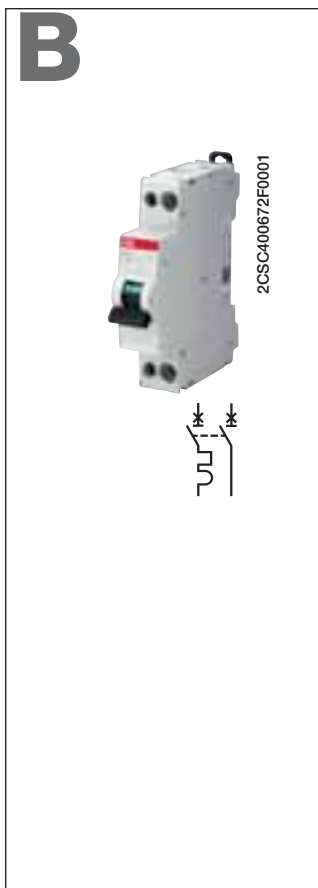

SN 201 - B characteristic

Function: overload and short-circuits protection of circuits in final distribution; protection of long cable lengths in TN and IT systems.

Applications: residential and commercial.

Standard: IEC/EN 60898

Icn: 6 kA

Number of poles	Rated current In A	Order details		Bbn 8012542 EAN	Price 1 piece	Price group	Weight 1 piece kg	Pack unit pc.
		Type	Order code					
1+N	6	SN201 B6	2CSS255101R0065	090762			0.110	6
	10	SN201 B10	2CSS255101R0105	090861			0.110	6
	16	SN201 B16	2CSS255101R0165	090960			0.110	6
	20	SN201 B20	2CSS255101R0205	091066			0.110	6
	25	SN201 B25	2CSS255101R0255	091165			0.110	6
	32	SN201 B32	2CSS255101R0325	091264			0.110	6
	40	SN201 B40	2CSS255101R0405	091363			0.110	6

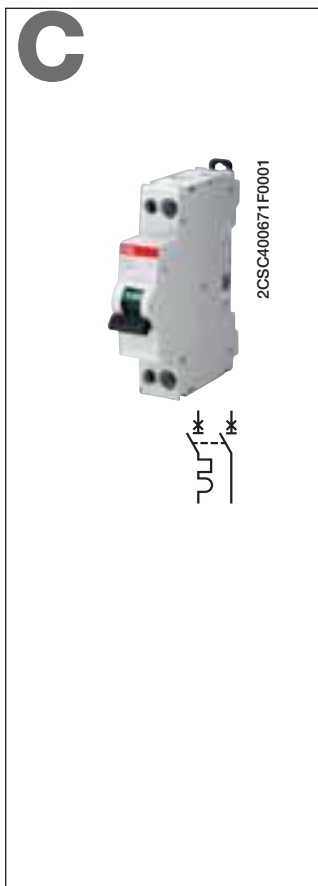

SN 201 - C characteristic

Function: overload and short-circuit protection of circuits in final distribution; protection of resistive and inductive loads with low inrush current.

Applications: residential and commercial.

Standard: IEC/EN 60898

Icn: 6 kA

Number of poles	Rated current In A	Order details		Bbn 8012542 EAN	Price 1 piece	Price group	Weight 1 piece kg	Pack unit pc.
		Type	Order code					
1+N	2	SN201 C2	2CSS255101R0024	091462			0.110	6
	4	SN201 C4	2CSS255101R0044	091561			0.110	6
	6	SN201 C6	2CSS255101R0064	091660			0.110	6
	10	SN201 C10	2CSS255101R0104	091769			0.110	6
	13	SN201 C13	2CSS255101R0134	091868			0.110	6
	16	SN201 C16	2CSS255101R0164	091967			0.110	6
	20	SN201 C20	2CSS255101R0204	092063			0.110	6
	25	SN201 C25	2CSS255101R0254	092162			0.110	6
	32	SN201 C32	2CSS255101R0324	092261			0.110	6
	40	SN201 C40	2CSS255101R0404	092360			0.110	6

6000

D



SN 201 - D characteristic

Function: protection and control of the circuits against overloads and short-circuits in final distribution; protection for circuits which supply loads with high inrush current at the circuit closing.

Applications: residential and commercial.

Standard: IEC/EN 60898

Icn: 6 kA

Number of poles	Rated current In A	Order details		Bbn 8012542 EAN	Price 1 piece	Price group	Weight 1 piece kg	Pack unit pc.
		Type	Order code					
1+N	6	SN201 D6	2CSS255101R0061	092469			0,110	6
	10	SN201 D10	2CSS255101R0101	092568			0,110	6
	16	SN201 D16	2CSS255101R0161	092667			0,110	6
	20	SN201 D20	2CSS255101R0201	092766			0,110	6
	25	SN201 D25	2CSS255101R0251	092865			0,110	6
	32	SN201 D32	2CSS255101R0321	092964			0,110	6
	40	SN201 D40	2CSS255101R0401	093060			0,110	6

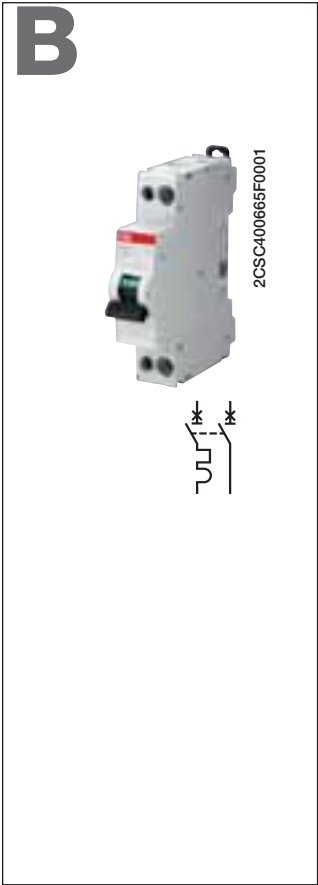

SN 201 M - B characteristic

Function: overloads and short-circuit protection of circuits in final distribution; protection of long cable lengths in TN and IT systems.

Applications: residential and commercial.

Standard: IEC/EN 60898

Icn: 10 kA

Number of poles	Rated current In A	Order details		Bbn 8012542 EAN	Price 1 piece	Price group	Weight 1 piece kg	Pack unit pc.
		Type	Order code					
1+N	6	SN201 M B6	2CSS275101R0065	093152			0.110	6
	10	SN201 M B10	2CSS275101R0105	093251			0.110	6
	16	SN201 M B16	2CSS275101R0165	093350			0.110	6
	20	SN201 M B20	2CSS275101R0205	093459			0.110	6
	25	SN201 M B25	2CSS275101R0255	093558			0.110	6
	32	SN201 M B32	2CSS275101R0325	093657			0.110	6
	40	SN201 M B40	2CSS275101R0405	093756			0.110	6

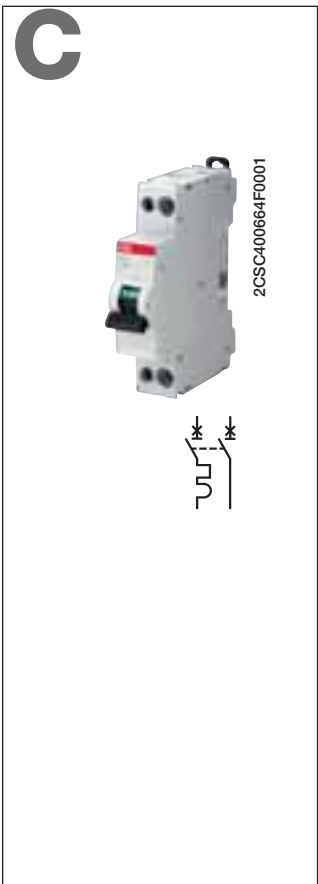

SN 201 M - C characteristic

Function: overload and short-circuit protection of circuits in final distribution; protection of resistive and inductive loads with low inrush current.

Applications: residential and commercial.

Standard: IEC/EN 60898

Icn: 10 kA

Number of poles	Rated current In A	Order details		Bbn 8012542 EAN	Price 1 piece	Price group	Weight 1 piece kg	Pack unit pc.
		Type	Order code					
1+N	2	SN201 M C2	2CSS275101R0024	093862			0.110	6
	4	SN201 M C4	2CSS275101R0044	093961			0.110	6
	6	SN201 M C6	2CSS275101R0064	094067			0.110	6
	10	SN201 M C10	2CSS275101R0104	094166			0.110	6
	16	SN201 M C16	2CSS275101R0164	094265			0.110	6
	20	SN201 M C20	2CSS275101R0204	094364			0.110	6
	25	SN201 M C25	2CSS275101R0254	094463			0.110	6
	32	SN201 M C32	2CSS275101R0324	094562			0.110	6
	40	SN201 M C40	2CSS275101R0404	094661			0.110	6

MCBs for heavy-duty industrial protection consist of three different ranges.

S 280 series, which includes the 80 A and 100 A rated current versions (one pole, one module), available in B and C characteristics, 6 kA breaking capacity according to IEC/EN 60898 Standard and 35 mm² size of the terminals. The range includes also the S 280 UC series that protects direct current circuits with high voltages.

In all circuit-breakers of the range there is no specific mechanical constraint between the case and the internal mechanical components which form three independent functional blocks: in this way, any distortion of the case, in the event of thermal shock, does not affect the correct functioning of the circuit-breaker. The supply lines of the protected circuit can be connected to either the upper or lower terminals of the circuit-breakers (reversibility of connections). The double terminal of these circuit-breakers enables simultaneous connection of cables and busbars.

S 290 series, for the use in switchboards and consumer units for modular devices with 45 mm slotting and rated currents up to 125 A. They can be mounted alongside standard modular circuit-breakers because of their modular design and ability to be installed on 35 mm DIN EN 50022 rails.

The circuit-breakers are available in 1-2-3-4 pole versions with a width equal to 1 module and a half per pole (27 mm); the characteristic curves are B, C, D and K.

S700 series is a range of selective main circuit breakers (smcb) for the use as main incoming protective device for any distribution board or meter cabinet.



2CSC400395F0201



2CSC400396F0201



2CSC400566F0201

The main application of S700 is the selective overload and short-circuit protection and isolation of circuits in 230/400 V installations. The outstanding selectivity in combination with high isolation capability and the suitability for the use by laymen are the main characteristics of this range, including single and multipole devices, different tripping characteristics and a broad range of accessories.

WT63 is a main current limiting device for the use in dedicated motor protection circuits. With WT 63 it is possible to create smart motor protection solutions for 690V applications, where WT63 can be used as a main current limiter for several motor groups - ensuring high breaking capacity by selective current limiting.

The extensive **S800** range offers the right high performance MCBs with high-rated breaking capacities and various tripping characteristics. The units of the S800S series, both AC and DC types, operate in a nominal current range of between 6 and 125 A covering breaking capacities of up to 50 kA.

The S800N is the ideal solution for applications of up to 36 kA, the S800C for applications up to 25 kA; of course also for current ratings of between 10 and 125 A.

The high-rated breaking capacities of up to 50 kA allow electrical distribution systems to be configured and operated safely in an uncomplicated manner.

Compact dimensions ensure that energy distribution systems can be set up in a space-saving way. S800 MCBs satisfy all the main standards and approvals.

For the photovoltaic market ABB supply the new S800PV range allowing complete protection in such innovative plants.

The heavy duty circuit breakers **S500** complete the range of the S800. The devices of the series S500K and S500UC-K provide the opportunity to adjust the rated current. This has the benefit to get a very precise tripping. The S500K has a short-circuit current of up to 50 kA.

The S500UC-K is only for DC applications such as railway systems or DC-networks. He offers a high rated operating voltage up to 750 V DC and a breaking capacity of up to 30 kA.



Miniature circuit-breakers S 280, S 290, S700, S800 and S500 series

Index

Technical features of MCBs S 280 series 80-100 A	2/58
Selection tables of MCBs S 280 series 80-100 A	
S 280 80-100 A-B	2/59
S 280 80-100 A-C	2/59
Technical features of MCBs S 280 UC series	2/60
Selection tables of MCBs S 280 UC series	
S 280-UC B	2/61
S 280-UC K	2/62
S 280-UC Z	2/64
Technical features of MCBs S 290 series	2/66
Selection tables of MCBs S 290 series	
S 290-B	2/67
S 290-C	2/68
S 290-D	2/69
S 290-K	2/70
Technical features of MCBs S700 series	2/71
Selection tables of MCBs S700 series	
S700 E	2/72
S700 K	2/73
S700 E+H2WR	2/74
S700 K+H2WR	2/75
WT63	2/76
Technical features of MCBs S800 series	2/77
Selection tables of MCBs S800 series	
S800S-B	2/82
S800S-C	2/86
S800S-D	2/90
S800S-K	2/94
S800S-KM	2/98
S800S-UCB	2/99
S800S-UCK	2/101
S800N-B	2/103
S800N-C	2/104
S800N-D	2/105
S800C-B	2/106
S800C-C	2/107
S800C-D	2/108
S800C-K	2/109
S800U-Z	2/110
S800U-K	2/111
S800PV-S	2/112
S800PV-M	2/113
Technical features of MCBs S500 series	2/114
Selection tables of MCBs S500 series	
S500-K	2/116
S500UC-K	2/118



S 280 80 - 100 A

Electrical Data		Standards	IEC/EN UL/CSA	IEC/EN 60898-1, IEC/EN 60947-2 -
	Poles			1P, 2P, 3P, 4P
	Tripping characteristics			B, C
	Rated current I_n		A	80...100 A
	Rated voltage U_n	IEC/EN 60898-1	V	1P: 230 V AC 2...4P: 400 V AC
	Rated voltage U_n	IEC/EN 60898-2	V	-
	Rated voltage U_e	IEC/EN 60947-2	V	1P: 230 - 240 V AC 2...4P: 230/400 - 240/415 V AC
	Rated voltage	UL/CSA	V	-
	Insulation voltage U_i	IEC/EN 60898-1 / 60947-2	V	250 V AC (phase to ground), 500 V AC (phase to phase)
	Max. operating voltage U_{Bmax}		V	1P: 253 V AC 2...4P: 440 V AC
	Min. operating voltage U_{Bmin}		V	12 V AC
	Rated frequency f		Hz	50 / 60 Hz
	Rated short-circuit capacity I_{cn}	IEC/EN 60898-1	kA	6 kA
	Ultimate short-circuit capacity I_{cu}	IEC/EN 60947-2	kA	6 kA
	Service short-circuit capacity I_{cs}	IEC/EN 60947-2	kA	6 kA
	Energy limiting class	IEC/EN 60898-1		-
	Overvoltage category	IEC/EN 60898-1 / 60947-2		III
	Pollution degree	IEC/EN 60898-1		2
		IEC/EN 60947-2		3
	Rated impulse withstand voltage U_{imp} (1.2/50 μ s)	IEC/EN 60898-1 / 60947-2	kV	4 kV (test voltage 6.2 kV at sea level, 5 kV at 2,000 m)
	Dielectric test voltage	IEC/EN 60898-1	kV	2 kV (50 / 60 Hz, 1 min.)
Mechanical Data				Insulation group I, RAL 7035
	Housing			
	Toggle			Insulation group II, black, sealable
	Contact position indication			Marking on toggle (I ON / 0 OFF), Real CPI (red ON / green OFF)
	Protection degree	IEC/EN 60529		IP20 / IPXXB, IP40 in enclosure with cover
	Electrical endurance		ops.	4,000 ops.
	Mechanical endurance		ops.	10,000 ops.
	Shock resistance	IEC/EN 60068-2-27		30 g - 3 shocks - 11 ms
	Vibration resistance	IEC/EN 60068-2-6		5 g - 20 cycles at 5...150...5 Hz with load 0.8 I_n
	Tropicalization (damp heat cyclic)	IEC/EN 60068-2-30	°C/RH	28 cycles with 55°C/90-96% and 25°C/95-100%
	Ambient temperature		°C	-25 ... +55°C
	Storage temperature		°C	-40 ... +70°C
	Reference temperature for tripping characteristics	IEC/EN 60898-1	°C	B, C: 30°C
		IEC/EN 60947-2		-
Installation				Cage (shock protected)
	Terminal			
	Cross-section of conductors (top / bottom)	IEC/EN 60898-1 / 60947-2	mm ²	35 mm ² / 35 mm ²
		UL/CSA	AWG	-
	Cross-section of busbars (top / bottom)	IEC/EN 60898-1 / 60947-2	mm ²	16 mm ² / 16 mm ²
		UL/CSA	AWG	-
	Torque	IEC/EN	Nm	2.5 Nm
		UL/CSA	in-lbs.	-
	Screwdriver			No. 2 Pozidrive
	Mounting			On DIN rail 35 mm acc. to EN 60715 by fast clip
	Mounting position			Any
	Supply			Optional
Dimensions and weight		DIN 43880		Mounting dimension 1
	Mounting dimensions			
	Pole dimensions (H x D x W)		mm	90 x 69 x 17.5 mm
	Pole weight		g	ca. 160 g
Combination with aux. elements				Yes
	signal contact/auxiliary switch			Yes
	shunt trip			Yes
	undervoltage release			Yes

6000

B & C



2CSC400474F0201



2CSC400475F0201



2CSC400476F0201



2CSC400477F0201



S 280 80-100A B characteristic

Function: protection and control of the circuits against overloads and short-circuits; protection for people and big length cables in TN and IT systems.

Applications: commercial and industrial.

Standard: IEC/EN 60898, IEC/EN 60947-2

Icn=6 kA

Number of poles	Rated current In A	Order details Type code	Order code	Bbn	Price 1 piece	Price group	Weight 1 piece kg	Pack unit pc.
				8012542				
1	80	S281 B80	GHS2810001R0805	499503			0.140	1/6
	100	S281 B100	GHS2810001R0825	499602			0.140	1/6
2	80	S282 B80	GHS2820001R0805	500100			0.275	1/3
	100	S282 B100	GHS2820001R0825	500209			0.275	1/3
3	80	S283 B80	GHS2830001R0805	500704			0.400	1/2
	100	S283 B100	GHS2830001R0825	500803			0.400	1/2
4	80	S284 B80	GHS2840001R0805	518006			0.525	1
	100	S284 B100	GHS2840001R0825	518105			0.525	1

S 280 80-100A C characteristic

Function: protection and control of the circuits against overloads and short-circuits; protection for resistive and inductive loads with low inrush current.

Applications: commercial and industrial.

Standard: IEC/EN 60898, IEC/EN 60947-2

Icn=6 kA

Number of poles	Rated current In A	Order details Type code	Order code	Bbn	Price 1 piece	Price group	Weight 1 piece kg	Pack unit pc.
				8012542				
1	80	S281 C80	GHS2810001R0804	499305			0.140	1/6
	100	S281 C100	GHS2810001R0824	499404			0.140	1/6
2	80	S282 C80	GHS2820001R0804	499909			0.275	1/3
	100	S282 C100	GHS2820001R0824	500001			0.275	1/3
3	80	S283 C80	GHS2830001R0804	500506			0.400	1/2
	100	S283 C100	GHS2830001R0824	500605			0.400	1/2
4	80	S284 C80	GHS2840001R0804	517801			0.525	1
	100	S284 C100	GHS2840001R0824	517900			0.525	1



S 280 UC				
Electrical Data	Standards	IEC/EN UL/CSA	Acc. to IEC/EN 60898-2, IEC/EN 60947-2 UL 1077, CSA 22.2 No. 235	
	Poles		1P, 2P, 3P, 4P	
	Tripping characteristics		B, K, Z	
	Rated current I_n		A	0.2...63 A
	Rated voltage U_n	IEC/EN 60898-1	V	–
	Rated voltage U_n	IEC/EN 60898-2	V	1P: 220 V DC, 230 V AC 2P: 400 V DC, 400 V AC
	Rated voltage U_e	IEC/EN 60947-2	V	1P: 220 V DC 2...4P: 440 V DC
	Rated voltage	UL/CSA	V	1P: 250 V DC, 277 V AC 2...4P: 500 V DC, 480 V AC
	Insulation voltage U_i	IEC/EN 60898-2 / 60947-2	V	250 V AC (phase to ground), 500 V AC (phase to phase)
	Max. operating voltage $U_{Bmax.}$		V	1P: 253 V AC, 242 V DC 2...4P: 440 V AC, 484 V DC
	Min. operating voltage $U_{Bmin.}$		V	12 V AC - 12 V DC
	Rated frequency f		Hz	50 / 60 Hz
	Rated short-circuit capacity I_{cn}	IEC/EN 60898-2	kA	≤ 40 A: 6 kA > 40 A: 4.5 kA
	Ultimate short-circuit capacity I_{cu}	IEC/EN 60947-2	kA	≤ 40 A: 6 kA > 40 A: 4.5 kA
	Service short-circuit capacity I_{cs}	IEC/EN 60947-2	kA	≤ 40 A: 6 kA > 40 A: 4.5 kA
	Rated interrupting capacity	UL 1077, CSA 22.2 No. 235	kA	4.5 kA (10 kA 60 V DC 1P, 125 V DC 2P)
	Energy limiting class	IEC/EN 60898-2		3
	Overvoltage category	IEC/EN 60898-2 / 60947-2		III
	Pollution degree	IEC/EN 60898-2 IEC/EN 60947-2		2 3
	Rated impulse withstand voltage $U_{imp.}$ (1.2/50 μs)	IEC/EN 60898-2 / 60947-2	kV	4 kV (test voltage 6.2 kV at sea level, 5 kV at 2,000 m)
Dielectric test voltage	IEC/EN 60898-2	kV	2 kV (50 / 60 Hz, 1 min.)	
Mechanical Data	Housing		Insulation group I, RAL 7035	
	Toggle		Insulation group II, black, sealable	
	Contact position indication		Marking on toggle (I ON / 0 OFF), Real CPI (red ON / green OFF)	
	Protection degree	IEC/EN 60529		IP20 / IPXXB, IP40 in enclosure with cover
	Electrical endurance		ops.	10,000 ops. (AC), 1,000 ops. (DC)
	Mechanical endurance		ops.	20,000 ops.
	Shock resistance	IEC/EN 60068-2-27		30 g - 3 shocks - 11 ms
	Vibration resistance	IEC/EN 60068-2-6		5g - 20 cycles at 5...150...5 Hz with load 0.8 I_n
	Tropicalization (damp heat cyclic)	IEC/EN 60068-2-30	°C/RH	28 cycles with 55°C/90-96% and 25°C/95-100%
	Ambient temperature		°C	-25 ... +55°C
	Storage temperature		°C	-40 ... +70°C
	Reference temperature for tripping characteristics	IEC/EN 60898-2 IEC/EN 60947-2	°C	B: 30°C K, Z: 20°C
	Installation	Terminal		Cage (shock protected)
Cross-section of conductors (top / bottom)		IEC/EN 60898-2 / 60947-2 UL/CSA	mm ² AWG	25 mm ² / 25 mm ² 18 - 4 AWG
Cross-section of busbars (top / bottom)		IEC/EN 60898-2 / 60947-2 UL/CSA	mm ² AWG	16 mm ² / 16 mm ² –
Torque		IEC/EN UL/CSA	Nm in-lbs.	2.5 Nm 17.5 in-lbs.
Screwdriver				No. 2 Pozidrive
Mounting				On DIN rail 35 mm acc. to EN 60715 by fast clip
Mounting position				Any
Supply				Please note polarity of device
Dimensions and weight	Mounting dimensions	DIN 43880		Mounting dimension 1
	Pole dimensions (H x D x W)		mm	90 x 69 x 17.5 mm
	Pole weight		g	ca. 140 g
Combination with aux. elements	signal contact/auxiliary switch			Yes
	shunt trip			Yes
	undervoltage release			Yes

B



2CSC400474F0201



2CSC400475F0201



S 280 series UC B characteristic

Function: protection and control of the circuits against overloads and short-circuits; protection for people and big length cables in TN and IT systems; version dedicated to application in direct current circuits for voltages up to 220 V DC 1 pole and 440 V DC 2, 3 and 4 poles.

Applications: industrial.

Standard: Acc. to IEC/EN 60898-2

Icn=6 kA

Number of poles	Rated current	Order details	Bbn 4016779	Price 1 piece	Price group	Weight 1 piece	Pack unit
	In A	Type code	Order code	EAN		kg	pc.
1	6	S281-UC B 6	GHS2810164R0065	162302		0.130	10/40
	10	S281-UC B10	GHS2810164R0105	162401		0.130	10/40
	UBmax 16	S281-UC B16	GHS2810164R0165	162500		0.130	10/40
	254 V~ 20	S281-UC B20	GHS2810164R0205	162609		0.130	10/40
	242 V -... 25	S281-UC B25	GHS2810164R0255	162708		0.130	10/40

2	6	S282-UC B 6	GHS2820164R0065	162807		0.260	5/20
	10	S282-UC B10	GHS2820164R0105	162906		0.260	5/20
	UBmax 16	S282-UC B16	GHS2820164R0165	163002		0.260	5/20
	440 V~ 20	S282-UC B20	GHS2820164R0205	163101		0.260	5/20
	440 V -... 25	S282-UC B25	GHS2820164R0255	163200		0.260	5/20

K



2CSC400474F0201



2CSC400475F0201



S 280 series UC K (power) characteristic

Function: protection and control of the circuits like motors and auxiliary circuits, against overloads and short-circuits; version dedicated to application in direct current circuits for voltages up to 220 V DC 1 pole and 440 V DC 2, 3 and 4 poles.

Advantages: no nuisance tripping in the case of functional peak currents up to 8xI_n, depending on the series; through its highly sensitive thermostatic bimetal trip, the K-type characteristic offers protection to damageable elements in the overcurrent range; it also provides the best protection to cables and lines.

Applications: industrial.

Standard: Acc. to IEC/EN 60947-2

I_{cu}=6 kA

Number of poles	Rated current	Order details	Bbn 4012233	Price 1 piece	Price group	Weight 1 piece	Pack unit
	In A	Type code	Order code	EAN		kg	pc.
1	0.2	S 281 UC-K 0.2	GHS2810164R0087	634200		0.130	10/40
	0.3	S 281 UC-K 0.3	GHS2810164R0117	634309		0.130	10/40
	0.5	S 281 UC-K 0.5	GHS2810164R0157	634408		0.130	10/40
	0.75	S 281 UC-K 0.75	GHS2810164R0187	635504		0.130	10/40
	1	S 281 UC-K 1	GHS2810164R0217	634606		0.130	10/40
	1.6	S 281 UC-K 1.6	GHS2810164R0257	634705		0.130	10/40
	2	S 281 UC-K 2	GHS2810164R0277	634804		0.130	10/40
	3	S 281 UC-K 3	GHS2810164R0317	634903		0.130	10/40
	4	S 281 UC-K 4	GHS2810164R0337	635009		0.130	10/40
	6	S 281 UC-K 6	GHS2810164R0377	635207		0.130	10/40
	8	S 281 UC-K 8	GHS2810164R0407	635108		0.130	10/40
	10	S 281 UC-K 10	GHS2810164R0427	635306		0.130	10/40
	16	S 281 UC-K 16	GHS2810164R0467	635405		0.130	10/40
	20	S 281 UC-K 20	GHS2810164R0487	635603		0.130	10/40
	25	S 281 UC-K 25	GHS2810164R0517	635702		0.130	10/40
32	S 281 UC-K 32	GHS2810164R0537	635801		0.130	10/40	
UBmax	40	S 281 UC-K 40	GHS2810164R0557	635900		0.130	10/40
254 V~	50	S 281 UC-K 50	GHS2810164R0577	636006		0.160	10/40
242 V ~...	63	S 281 UC-K 63	GHS2810164R0607	636105		0.160	10/40

2	0.2	S 282 UC-K 0.2	GHS2820164R0087	636204		0.260	5/20
	0.3	S 282 UC-K 0.3	GHS2820164R0117	636303		0.260	5/20
	0.5	S 282 UC-K 0.5	GHS2820164R0157	636402		0.260	5/20
	0.75	S 282 UC-K 0.75	GHS2820164R0187	636501		0.260	5/20
	1	S 282 UC-K 1	GHS2820164R0217	636600		0.260	5/20
	1.6	S 282 UC-K 1.6	GHS2820164R0257	636709		0.260	5/20
	2	S 282 UC-K 2	GHS2820164R0277	652808		0.260	5/20
	3	S 282 UC-K 3	GHS2820164R0317	636808		0.260	5/20
	4	S 282 UC-K 4	GHS2820164R0337	636907		0.260	5/20
	6	S 282 UC-K 6	GHS2820164R0377	637003		0.260	5/20
	8	S 282 UC-K 8	GHS2820164R0407	637102		0.260	5/20
	10	S 282 UC-K 10	GHS2820164R0427	637201		0.260	5/20
	16	S 282 UC-K 16	GHS2820164R0467	637300		0.260	5/20
	20	S 282 UC-K 20	GHS2820164R0487	637409		0.260	5/20
	25	S 282 UC-K 25	GHS2820164R0517	637508		0.260	5/20
32	S 282 UC-K 32	GHS2820164R0537	637607		0.260	5/20	
UBmax	40	S 282 UC-K 40	GHS2820164R0557	637706		0.260	5/20
440 V~	50	S 282 UC-K 50	GHS2820164R0577	637904		0.320	5/20
440 V ~...	63	S 282 UC-K 63	GHS2820164R0607	638000		0.320	5/20

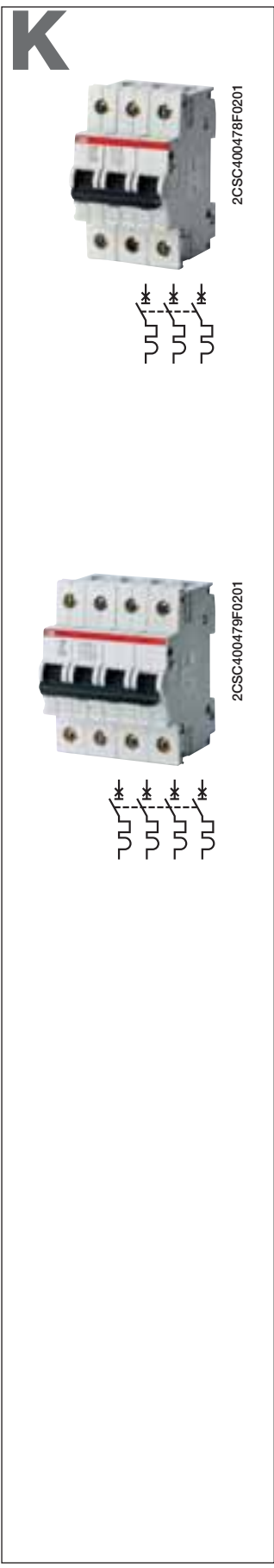

3	0.2	S 283 UC-K 0.2	GHS2830164R0087	738106	0.390	3/12
	0.3	S 283 UC-K 0.3	GHS2830164R0117	738205	0.390	3/12
	0.5	S 283 UC-K 0.5	GHS2830164R0157	738304	0.390	3/12
	0.75	S 283 UC-K 0.75	GHS2830164R0187	738403	0.390	3/12
	1	S 283 UC-K 1	GHS2830164R0217	738502	0.390	3/12
	1.6	S 283 UC-K 1.6	GHS2830164R0257	738601	0.390	3/12
	2	S 283 UC-K 2	GHS2830164R0277	738700	0.390	3/12
	3	S 283 UC-K 3	GHS2830164R0317	738809	0.390	3/12
	4	S 283 UC-K 4	GHS2830164R0337	738908	0.390	3/12
	6	S 283 UC-K 6	GHS2830164R0377	739004	0.390	3/12
	8	S 283 UC-K 8	GHS2830164R0407	739103	0.390	3/12
	10	S 283 UC-K 10	GHS2830164R0427	739202	0.390	3/12
	16	S 283 UC-K 16	GHS2830164R0467	739301	0.390	3/12
	20	S 283 UC-K 20	GHS2830164R0487	739400	0.390	3/12
	25	S 283 UC-K 25	GHS2830164R0517	739509	0.390	3/12
32	S 283 UC-K 32	GHS2830164R0537	739608	0.390	3/12	
UBmax	40	S 283 UC-K 40	GHS2830164R0557	739707	0.390	3/12
440 V~	50	S 283 UC-K 50	GHS2830164R0577	739806	0.480	3/12
440 V -...	63	S 283 UC-K 63	GHS2830164R0607	739905	0.480	3/12

4	0.2	S 284 UC-K 0.2	GHS2840164R0087	741601	0.520	2
	0.3	S 284 UC-K 0.3	GHS2840164R0117	741700	0.520	2
	0.5	S 284 UC-K 0.5	GHS2840164R0157	741809	0.520	2
	0.75	S 284 UC-K 0.75	GHS2840164R0187	741908	0.520	2
	1	S 284 UC-K 1	GHS2840164R0217	742004	0.520	2
	1.6	S 284 UC-K 1.6	GHS2840164R0257	742103	0.520	2
	2	S 284 UC-K 2	GHS2840164R0277	742202	0.520	2
	3	S 284 UC-K 3	GHS2840164R0317	742301	0.520	2
	4	S 284 UC-K 4	GHS2840164R0337	742400	0.520	2
	6	S 284 UC-K 6	GHS2840164R0377	742509	0.520	2
	8	S 284 UC-K 8	GHS2840164R0407	742608	0.520	2
	10	S 284 UC-K 10	GHS2840164R0427	742707	0.520	2
	16	S 284 UC-K 16	GHS2840164R0467	742806	0.520	2
	20	S 284 UC-K 20	GHS2840164R0487	743001	0.520	2
	25	S 284 UC-K 25	GHS2840164R0517	743100	0.520	2
32	S 284 UC-K 32	GHS2840164R0537	743209	0.520	2	
UBmax	40	S 284 UC-K 40	GHS2840164R0557	743308	0.520	2
440 V~	50	S 284 UC-K 50	GHS2840164R0577	743407	0.640	2
440 V -...	63	S 284 UC-K 63	GHS2840164R0607	743506	0.640	2

Z



2CSC400480F0201



2CSC400481F0201



S 280 series UC Z characteristic

Function: protection and control of the electronic circuits against weak and long duration overloads and short-circuits; version dedicated to application in direct current circuits for voltages up to 220 V DC 1 pole and 440 V DC 2, 3 and 4 poles.

Applications: industrial.

Standard: Acc. to IEC/EN 60947-2

Icu=6 kA

Number of poles	Rated current	Order details		Bbn 4012233	Price 1 piece	Price group	Weight 1 piece	Pack unit
In A	Type code	Order code	EAN				kg	pc.
1	0.5	S 281 UC-Z 0.5	GHS2810164R0158	638604			0.130	10/40
	1	S 281 UC-Z 1	GHS2810164R0218	638703			0.130	10/40
	1.6	S 281 UC-Z 1.6	GHS2810164R0258	638802			0.130	10/40
	2	S 281 UC-Z 2	GHS2810164R0278	638901			0.130	10/40
	3	S 281 UC-Z 3	GHS2810164R0318	639007			0.130	10/40
	4	S 281 UC-Z 4	GHS2810164R0338	639106			0.130	10/40
	6	S 281 UC-Z 6	GHS2810164R0378	639205			0.130	10/40
	8	S 281 UC-Z 8	GHS2810164R0408	639403			0.130	10/40
	10	S 281 UC-Z 10	GHS2810164R0428	639502			0.130	10/40
	16	S 281 UC-Z 16	GHS2810164R0468	639601			0.130	10/40
	20	S 281 UC-Z 20	GHS2810164R0488	639700			0.130	10/40
	25	S 281 UC-Z 25	GHS2810164R0518	639809			0.130	10/40
	32	S 281 UC-Z 32	GHS2810164R0538	639908			0.130	10/40
	UBmax	40	S 281 UC-Z 40	GHS2810164R0558	640003			0.130
254 V~	50	S 281 UC-Z 50	GHS2810164R0578	640102			0.160	10/40
242 V ...	63	S 281 UC-Z 63	GHS2810164R0608	640201			0.160	10/40

2	0.5	S 282 UC-Z 0.5	GHS2820164R0158	640300			0.260	5/20
	1	S 282 UC-Z 1	GHS2820164R0218	640409			0.260	5/20
	1.6	S 282 UC-Z 1.6	GHS2820164R0258	642304			0.260	5/20
	2	S 282 UC-Z 2	GHS2820164R0278	641000			0.260	5/20
	3	S 282 UC-Z 3	GHS2820164R0318	641109			0.260	5/20
	4	S 282 UC-Z 4	GHS2820164R0338	641208			0.260	5/20
	6	S 282 UC-Z 6	GHS2820164R0378	641307			0.260	5/20
	8	S 282 UC-Z 8	GHS2820164R0408	641406			0.260	5/20
	10	S 282 UC-Z 10	GHS2820164R0428	641505			0.260	5/20
	16	S 282 UC-Z 16	GHS2820164R0468	641604			0.260	5/20
	20	S 282 UC-Z 20	GHS2820164R0488	641703			0.260	5/20
	25	S 282 UC-Z 25	GHS2820164R0518	641802			0.260	5/20
	32	S 282 UC-Z 32	GHS2820164R0538	641901			0.260	5/20
	UBmax	40	S 282 UC-Z 40	GHS2820164R0558	642007			0.260
440 V~	50	S 282 UC-Z 50	GHS2820164R0578	642106			0.320	5/20
440 V ...	63	S 282 UC-Z 63	GHS2820164R0608	642205			0.320	5/20

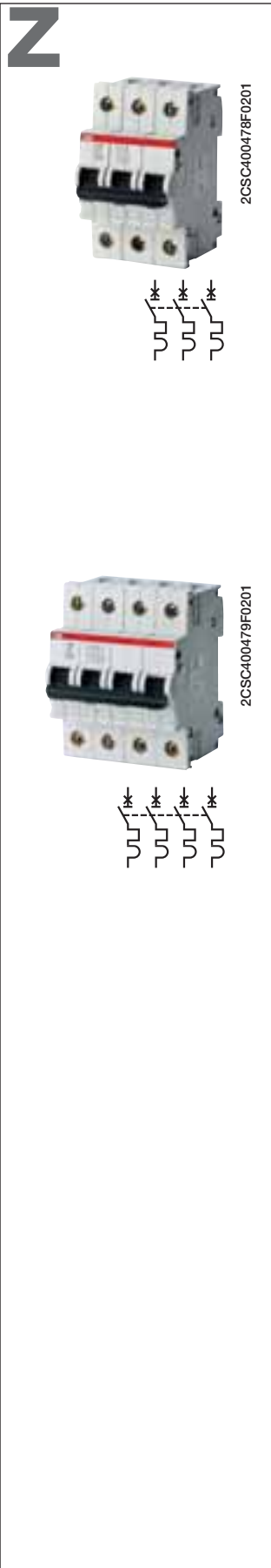

3	0.5	S 283 UC-Z 0.5	GHS2830164R0158	740000	0.390	3/12
	1	S 283 UC-Z 1	GHS2830164R0218	740109	0.390	3/12
	1.6	S 283 UC-Z 1.6	GHS2830164R0258	740208	0.390	3/12
	2	S 283 UC-Z 2	GHS2830164R0278	740307	0.390	3/12
	3	S 283 UC-Z 3	GHS2830164R0318	740406	0.390	3/12
	4	S 283 UC-Z 4	GHS2830164R0338	740505	0.390	3/12
	6	S 283 UC-Z 6	GHS2830164R0378	740604	0.390	3/12
	8	S 283 UC-Z 8	GHS2830164R0408	740703	0.390	3/12
	10	S 283 UC-Z 10	GHS2830164R0428	740802	0.390	3/12
	16	S 283 UC-Z 16	GHS2830164R0468	740901	0.390	3/12
	20	S 283 UC-Z 20	GHS2830164R0488	741007	0.390	3/12
	25	S 283 UC-Z 25	GHS2830164R0518	741106	0.390	3/12
	32	S 283 UC-Z 32	GHS2830164R0538	741205	0.390	3/12
UBmax	40	S 283 UC-Z 40	GHS2830164R0558	741304	0.390	3/12
440 V~	50	S 283 UC-Z 50	GHS2830164R0578	741403	0.480	3/12
440 V -...	63	S 283 UC-Z 63	GHS2830164R0608	741502	0.480	3/12

4	0.5	S 284 UC-Z 0.5	GHS2840164R0158	743605	0.520	2
	1	S 284 UC-Z 1	GHS2840164R0218	743704	0.520	2
	1.6	S 284 UC-Z 1.6	GHS2840164R0258	743803	0.520	2
	2	S 284 UC-Z 2	GHS2840164R0278	743902	0.520	2
	3	S 284 UC-Z 3	GHS2840164R0318	744008	0.520	2
	4	S 284 UC-Z 4	GHS2840164R0338	744107	0.520	2
	6	S 284 UC-Z 6	GHS2840164R0378	744206	0.520	2
	8	S 284 UC-Z 8	GHS2840164R0408	744305	0.520	2
	10	S 284 UC-Z 10	GHS2840164R0428	744404	0.520	2
	16	S 284 UC-Z 16	GHS2840164R0468	744503	0.520	2
	20	S 284 UC-Z 20	GHS2840164R0488	744602	0.520	2
	25	S 284 UC-Z 25	GHS2840164R0518	744701	0.520	2
	32	S 284 UC-Z 32	GHS2840164R0538	744800	0.520	2
UBmax	40	S 284 UC-Z 40	GHS2840164R0558	744909	0.520	2
440 V~	50	S 284 UC-Z 50	GHS2840164R0578	745005	0.640	2
440 V -...	63	S 284 UC-Z 63	GHS2840164R0608	745104	0.640	2



				S 290
Electrical Data	Standards	IEC/EN UL/CSA		IEC/EN 60898-1, IEC/EN 60947-2 UL 1077
	Poles			1P, 2P, 3P, 4P
	Tripping characteristics			B, C, D, K
	Rated current I_n		A	80...125 A
	Rated voltage U_n	IEC/EN 60898-1	V	1P: 230 V AC 2...4P: 400 V AC
	Rated voltage U_n	IEC/EN 60898-2	V	–
	Rated voltage U_e	IEC/EN 60947-2	V	1P: 230 V AC 2...4P: 230/400 V AC
	Rated voltage	UL/CSA	V	1P: 277 V AC 2...4P: 480/277 V AC
	Insulation voltage U_i	IEC/EN 60898-1 / 60947-2	V	250 V AC (phase to ground), 500 V AC (phase to phase)
	Max. operating voltage $U_{Bmax.}$		V	IEC: 253/440 V AC UL: 480/277 V AC IEC/UL 1P: 60 V DC; 2P...4P: 125 V DC
	Min. operating voltage $U_{Bmin.}$		V	24 V AC - 24 V DC
	Rated frequency f		Hz	50 / 60 Hz
	Rated short-circuit capacity I_{cn}	IEC/EN 60898-1	kA	10 kA
	Ultimate short-circuit capacity I_{cu}	IEC/EN 60947-2	kA	B, C: 20 kA D, K: 15 kA
	Service short-circuit capacity I_{cs}	IEC/EN 60947-2	kA	B, C: 10 kA D, K: 8 kA
	Rated interrupting capacity	UL 1077	kA	5 kA
	Energy limiting class	IEC/EN 60898-1		–
	Overvoltage category	IEC/EN 60898-1 / 60947-2		III
	Pollution degree	IEC/EN 60898-1 IEC/EN 60947-2		3 –
	Rated impulse withstand voltage $U_{imp.}$ (1.2/50 μ s)	IEC/EN 60898-1 / 60947-2	kV	4 kV (test voltage 6.2kV at sea level, 5 kV at 2,000 m)
Dielectric test voltage	IEC/EN 60898-1	kV	2 kV (50 / 60 Hz, 1 min.)	
Mechanical Data	Housing			black, sealable
	Toggle			Real CPI (red ON / green OFF)
	Contact position indication			IP20 with connected conductors / IPXXB, IP40 in enclosure with cover
	Protection degree	IEC/EN 60529		
	Electrical endurance		ops.	10,000 ops.
	Mechanical endurance		ops.	20,000 ops.
	Shock resistance	IEC/EN 60068-2-27		15 g - 1 shock - 11 ms
	Vibration resistance	IEC/EN 60068-2-6		5g at 25...150 Hz, 6g at 35 Hz (4s) with load 0.8 I_n
	Tropicalization (damp heat cyclic)	IEC/EN 60068-2-30	°C/RH	28 cycles with 55°C/90-96% and 25°C/95-100%
	Ambient temperature		°C	-25 ... +45°C
	Storage temperature		°C	-40 ... +70°C
Reference temperature for tripping characteristics	IEC/EN 60898-1 IEC/EN 60947-2	°C	B, C, D: 30°C K: 20°C	
Installation	Terminal			Cage (shock protected)
	Cross-section of conductors (top / bottom)	IEC/EN 60898-1 / 60947-2 UL/CSA	mm ² AWG	50 mm ² / 50 mm ² 14 - 2 AWG
	Cross-section of busbars (top / bottom)	IEC/EN 60898-1 / 60947-2 UL/CSA	mm ² AWG	– –
	Torque	IEC/EN UL/CSA	Nm in-lbs.	2.5...3.5 Nm 22 - 31 in-lbs.
	Screwdriver			No. 2 Pozidrive
	Mounting			On DIN rail 35 mm acc. to EN 60715 by fast clip
	Mounting position			Any
Supply			Optional	
Dimensions and weight	Mounting dimensions	DIN 43880		–
	Pole dimensions (H x D x W)		mm	90 x 70 x 26.25 mm
	Pole weight		g	ca. 258 g
Combination with aux. elements	signal contact/auxiliary switch			Yes
	shunt trip			Yes
	undervoltage release			Yes

10000

B

S 290 B characteristic

Function: protection and control of the circuits against overloads and short-circuits; protection for people and big length cables in TN and IT systems.

Applications: commercial and industrial.

Standard: IEC/EN 60898-1, IEC/EN 60947-2

Icn=10 kA

2

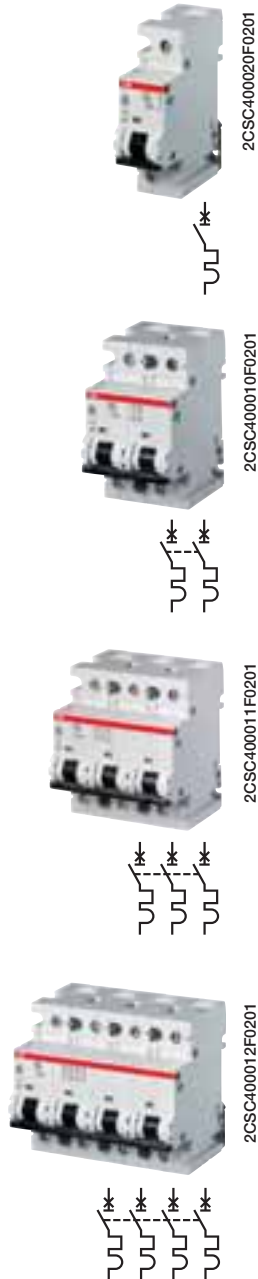

Number of poles	Rated current In A	Order details		Bbn 4016797	Price 1 piece	Price group	Weight 1 piece kg	Pack unit pc.
		Type code	Order code					
1	80	S291 B 80	GHS2912001R0805	12163			0.267	1/6
	100	S291 B100	GHS2912001R0825	12170			0.267	1/6
	125	S291 B125	GHS2912001R0845	12187			0.267	1/6
2	80	S292 B 80	GHS2922001R0805	09583			0.534	1/3
	100	S292 B100	GHS2922001R0825	09590			0.534	1/3
	125	S292 B125	GHS2922001R0845	12194			0.534	1/3
3	80	S293 B 80	GHS2932001R0805	09606			0.801	1/2
	100	S293 B100	GHS2932001R0825	09613			0.801	1/2
	125	S293 B125	GHS2932001R0845	12200			0.801	1/2
4	80	S294 B 80	GHS2942001R0805	11968			1.068	1
	100	S294 B100	GHS2942001R0825	11975			1.068	1
	125	S294 B125	GHS2942001R0845	12217			1.068	1

10000

C

S 290 C characteristic

Function: protection and control of the circuits against overloads and short-circuits when high nominal currents are required; protection for resistive and inductive loads with low inrush current.

Applications: commercial and industrial.

Standard: IEC/EN 60898, IEC/EN 60947-2

I_{cn}=10 kA

Number of poles	Rated current	Order details		Bbn 4016799	Price 1 piece	Price group	Weight 1 piece	Pack unit
	In A	Type code	Order code	EAN			kg	pc.
1	80	S291 C 80	GHS2912001R0804	570541			0.267	1/6
	100	S291 C100	GHS2912001R0824	570572			0.267	1/6
	125	S291 C125	GHS2912001R0844	570602			0.267	1/6
2	80	S292 C 80	GHS2922001R0804	570626			0.534	1/3
	100	S292 C100	GHS2922001R0824	570657			0.534	1/3
	125	S292 C125	GHS2922001R0844	570688			0.534	1/3
3	80	S293 C 80	GHS2932001R0804	570701			0.801	1/2
	100	S293 C100	GHS2932001R0824	570732			0.801	1/2
	125	S293 C125	GHS2932001R0844	570763			0.801	1/2
4	80	S294 C 80	GHS2942001R0804	570787			1.068	1
	100	S294 C100	GHS2942001R0824	570732			1.068	1
	125	S294 C125	GHS2942001R0844	570848			1.068	1



2CSC400020F0201



2CSC400010F0201



2CSC400011F0201



2CSC400012F0201



10000

D

S 290 D characteristic

Function: protection and control of the circuits against overloads and short-circuits when high nominal current are required; protection for circuits which supply loads with high inrush current at the circuit closing (motors, LV / LV transformers, breakdown lamps).

Applications: commercial and industrial.

Standard: IEC/EN 60898, IEC/EN 60947-2

Icn=10 kA

2

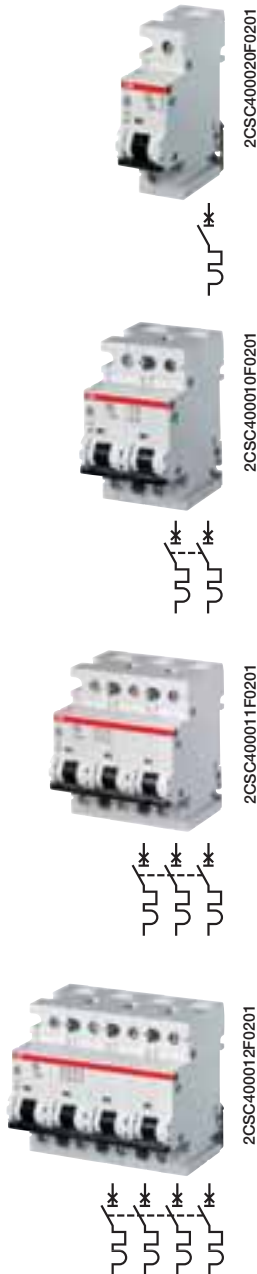

Number of poles	Rated current	Order details	Bbn 4016799	Price 1 piece	Price group	Weight 1 piece	Pack unit
	In A	Type code	Order code	EAN		kg	pc.
1	80	S291 D 80	GHS2912001R0801	120807		0.267	1/6
	100	S291 D 100	GHS2912001R0821	120906		0.267	1/6
2	80	S292 D 80	GHS2922001R0801	121002		0.534	1/3
	100	S292 D 100	GHS2922001R0821	121507		0.534	1/3
3	80	S293 D 80	GHS2932001R0801	121705		0.801	1/2
	100	S293 D 100	GHS2932001R0821	121804		0.801	1/2
4	80	S294 D 80	GHS2942001R0801	121200		1.068	1
	100	S294 D 100	GHS2942001R0821	121309		1.068	1

10000

K

S 290 K (power) characteristic

Function: protection and control of the circuits like motors, transformer and auxiliary circuits, against overloads and short-circuits when high nominal current are required.

Advantages: no nuisance tripping in the case of functional peak currents up to $8xI_n$, depending on the series; through its highly sensitive thermostatic bimetal trip, the K-type characteristic offers protection to damageable elements in the overcurrent range; it also provides the best protection to cables and lines.

Applications: commercial and industrial.

Standard: IEC/EN 60947-2, VDE 0660 Part 101

$I_{cn}=10\text{ kA}$



2CSC400020F0201



2CSC400010F0201



2CSC400011F0201



2CSC400012F0201



Number of poles	Rated current	Order details	Bbn 4016799	Price 1 piece	Price group	Weight 1 piece	Pack unit
In A	Type code	Order code	EAN			kg	pc.
1	80	S291 K 80	GHS2912001R0807	570558		0.267	1/6
	100	S291 K100	GHS2912001R0827	570589		0.267	1/6
2	80	S292 K 80	GHS2922001R0807	570633		0.534	1/3
	100	S292 K100	GHS2922001R0827	570664		0.534	1/3
3	80	S293 K 80	GHS2932001R0807	570718		0.801	1/2
	100	S293 K100	GHS2932001R0827	570749		0.801	1/2
4	80	S294 K 80	GHS2942001R0807	570794		1.068	1
	100	S294 K100	GHS2942001R0827	570824		1.068	1

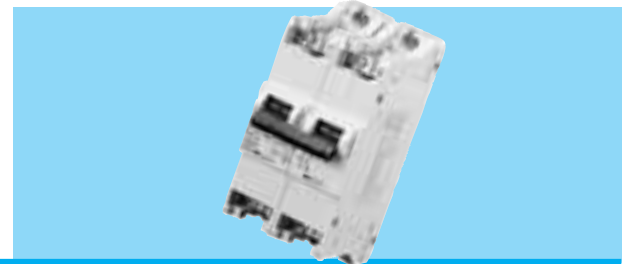

TECHNICAL FEATURES		S700	
	Standards	E DIN VDE 0645, IEC/EN 60947-2 (VDE 0660-101)	
Electrical features	Rated current, I _n	[A] 10 ... 100	
	Rated voltage, U _n	[V] 230/400	
	Tripping characteristic		E, K
		thermal tripping	1,05 ... 1,2 x I _n
		short-time delayed tripping	E: 5 ... 6,25 x I _n K: 10 ... 14 x I _n (≤ 50 A), 8 ... 12 x I _n (≥ 63 A)
		minimum tripping delay [ms]	10
	Rated breaking capacity	[kA]	25
	Rated frequency	[Hz]	50
	Rated isolation voltage	[V]	690
	Rated impulse withstand capability (at 2000 m)	[kV]	6
	Impulse withstand test voltage (1.2/50 μs)	[kV]	12.3
	Isolation coordination	overvoltage category	IV
pollution degree		3	
isolation function		acc. to IEC 60364-53, VDE 0100-537	
Dielectric strength test voltage	[V]	2000 (50 Hz, 1 min.)	
IP protection		depending on type of terminal cover	
Mechanical features	Mechanical switching cycles	without load	1000
		with rated current	1000
	Shock resistance		30 g (≥ 3 shocks, 11 ms)
	Resistance to vibrations		2 g (20 cycles 5...150...5 Hz)
	Reference temperature	[°C]	30 (E), 20 (K)
	Ambient temperature	storage	[°C] -40 ... +70
		operating	[°C] -25 ... +55
Sealing/locking		sealable with 1 mm wire, lockable with 3 mm padlock, see also special accessories	
Installation	Mounting		surface mounting with 2 screws, DIN rail mounting (35 mm DIN rail acc. to EN 60715, 40 mm-busbar systems (4/5-pole, 5/10 mm x 12 mm)
	Terminal type		saddle clamping
	Terminal size		capable to connect solid and rigid stranded conductors incl. flexible conductors 2.5...50 mm ² /70 mm ²
	Terminal screws tightening torque	[Nm]	2.5 ... 3
	Max. torque for surface mounting	[Nm]	2.5 ... 3 (only fl at-headed screws, no circlips)
	Source/load side		no preferences
Dimensions and weight	Size		see drawings
	Weight		see order tables
Accessories			Factory assembled auxiliary switch (2 change-over contacts)
			Terminal covers
			Handle covers
			Busbar adapters
			DIN rail adapters
			Locking devices

E

selective
25.000 A

2



S0029b98



S0011b95



S0001B95



S0012b95



S700 E characteristic

Breakers of the S700 series are selective main circuit breakers for overcurrent protection in electrical installations. They have total selectivity to downstream mcb's and outstanding selectivity to upstream protective devices due to unique current limiting selectivity. Since S700 breakers are designed for overvoltage category IV and incorporate isolation function, they are predestinated for the use in any main distribution cabinet or meter board.

The S700 product range is completed by a broad range of accessories. With dedicated adapters, S700 products can be assembled on flat surfaces, on DIN rails or 40 mm busbar systems. To adapt S700 to different installations, they are available 1- to 4-pole with tripping characteristic E and K - optional with factory assembled auxiliary switch.

Number of poles	Rated current In A	Order details Type code	Order code	Bbn 4012233 EAN	Price 1 piece	Price group	Weight 1 piece kg	Pack unit pc.
1	10	S701-E 10	GHS7015001 R0449	522507			0.55	3
	16	S701-E 16	GHS7015001 R0469	522705			0.55	3
	20	S701-E 20	GHS7015001 R0489	522903			0.55	3
	25	S701-E 25	GHS7015001 R0519	523108			0.55	3
	32	S701-E 32	GHS7015001 R0529	523207			0.55	3
	35	S701-E 35	GHS7015001 R0539	523405			0.55	3
	40	S701-E 40	GHS7015001 R0559	523603			0.55	3
	50	S701-E 50	GHS7015001 R0579	523801			0.55	3
	63	S701-E 63	GHS7015001 R0599	524006			0.55	3
	80	S701-E 80	GHS7015001 R0629	524204			0.55	3
	100	S701-E 100	GHS7015001 R0639	524402			0.55	3
2	16	S702-E 16	GHS7025001 R0469	105200 ¹⁾			1.1	2
	20	S702-E 20	GHS7025001 R0489	949007			1.1	2
	25	S702-E 25	GHS7025001 R0519	104005 ¹⁾			1.1	2
	32	S702-E 32	GHS7025001 R0529	105408 ¹⁾			1.1	2
	35	S702-E 35	GHS7025001 R0539	105309 ¹⁾			1.1	2
	40	S702-E 40	GHS7025001 R0559	105507 ¹⁾			1.1	2
	50	S702-E 50	GHS7025001 R0579	105606 ¹⁾			1.1	2
	63	S702-E 63	GHS7025001 R0599	052009 ¹⁾			1.1	2
	80	S702-E 80	GHS7025001 R0629	109604 ¹⁾			1.1	2
	100	S702-E 100	GHS7025001 R0639	062503 ¹⁾			1.1	2
3	16	S703-E 16	GHS7035001 R0469	865703			1.65	1
	20	S703-E 20	GHS7035001 R0489	526307			1.65	1
	25	S703-E 25	GHS7035001 R0519	526505			1.65	1
	32	S703-E 32	GHS7035001 R0529	526604			1.65	1
	35	S703-E 35	GHS7035001 R0539	526802			1.65	1
	40	S703-E 40	GHS7035001 R0559	527007			1.65	1
	50	S703-E 50	GHS7035001 R0579	527205			1.65	1
	63	S703-E 63	GHS7035001 R0599	527403			1.65	1
	80	S703-E 80	GHS7035001 R0629	527601			1.65	1
	100	S703-E 100	GHS7035001 R0639	527809			1.65	1
4	16	S704-E 16	GHS7045001 R0469	110600 ¹⁾			2.2	1
	20	S704-E 20	GHS7045001 R0489	110709 ¹⁾			2.2	1
	25	S704-E 25	GHS7045001 R0519	104104 ¹⁾			2.2	1
	32	S704-E 32	GHS7045001 R0529	110808 ¹⁾			2.2	1
	35	S704-E 35	GHS7045001 R0539	104203 ¹⁾			2.2	1
	40	S704-E 40	GHS7045001 R0559	110907 ¹⁾			2.2	1
	50	S704-E 50	GHS7045001 R0579	111003 ¹⁾			2.2	1
	63	S704-E 63	GHS7045001 R0599	111102 ¹⁾			2.2	1
	80	S704-E 80	GHS7045001 R0629	111201 ¹⁾			2.2	1
	100	S704-E 100	GHS7045001 R0639	062602 ¹⁾			2.2	1

¹⁾ bbn-Nr. 40 16779

K

selective
25.000 A



S0029b98



S0011b95



S0001b95



S0012b95



S700 K characteristic

Breakers of the S700 series are selective main circuit breakers for overcurrent protection in electrical installations. They have total selectivity to downstream mcb's and outstanding selectivity to upstream protective devices due to unique current limiting selectivity. Since S700 breakers are designed for overvoltage category IV and incorporate isolation function, they are predestinated for the use in any main distribution cabinet or meter board.

The S700 product range is completed by a broad range of accessories. With dedicated adapters, S700 products can be assembled on flat surfaces, on DIN rails or 40 mm busbar systems. To adapt S700 to different installations, they are available 1- to 4-pole with tripping characteristic E and K - optional with factory assembled auxiliary switch.

Number of poles	Rated current In A	Order details Type code	Order code	Bbn 4012233 EAN	Price 1 piece	Price group	Weight 1 piece kg	Pack unit pc.
1	16	S701-K 16	GHS7015001R0467	522606			0.55	3
	20	S701-K 20	GHS7015001R0487	522804			0.55	3
	25	S701-K 25	GHS7015001R0517	523009			0.55	3
	35	S701-K 35	GHS7015001R0537	523306			0.55	3
	40	S701-K 40	GHS7015001R0557	523504			0.55	3
	50	S701-K 50	GHS7015001R0577	523702			0.55	3
	63	S701-K 63	GHS7015001R0597	523900			0.55	3
	80	S701-K 80	GHS7015001R0627	524105			0.55	3
	100	S701-K 100	GHS7015001R0637	524303			0.55	3
2	16	S702-K 16	GHS7025001R0467	109802¹⁾			1.1	2
	20	S702-K 20	GHS7025001R0487	109703¹⁾			1.1	2
	25	S702-K 25	GHS7025001R0517	109901¹⁾			1.1	2
	35	S702-K 35	GHS7025001R0537	110006¹⁾			1.1	2
	40	S702-K 40	GHS7025001R0557	110105¹⁾			1.1	2
	50	S702-K 50	GHS7025001R0577	110204¹⁾			1.1	2
	63	S702-K 63	GHS7025001R0597	110303¹⁾			1.1	2
	80	S702-K 80	GHS7025001R0627	110402¹⁾			1.1	2
	100	S702-K 100	GHS7025001R0637	110501¹⁾			1.1	2
3	16	S703-K 16	GHS7035001R0467	526109			1.65	1
	20	S703-K 20	GHS7035001R0487	526208			1.65	1
	25	S703-K 25	GHS7035001R0517	526406			1.65	1
	35	S703-K 35	GHS7035001R0537	526703			1.65	1
	40	S703-K 40	GHS7035001R0557	526901			1.65	1
	50	S703-K 50	GHS7035001R0577	527106			1.65	1
	63	S703-K 63	GHS7035001R0597	527304			1.65	1
	80	S703-K 80	GHS7035001R0627	527502			1.65	1
	100	S703-K 100	GHS7035001R0637	527700			1.65	1
4	16	S704-K 16	GHS7045001R0467	111300¹⁾			2.2	1
	20	S704-K 20	GHS7045001R0487	111409¹⁾			2.2	1
	25	S704-K 25	GHS7045001R0517	111508¹⁾			2.2	1
	35	S704-K 35	GHS7045001R0537	111607¹⁾			2.2	1
	40	S704-K 40	GHS7045001R0557	111706¹⁾			2.2	1
	50	S704-K 50	GHS7045001R0577	965205			2.2	1
	63	S704-K 63	GHS7045001R0597	955503			2.2	1
	80	S704-K 80	GHS7045001R0627	111805¹⁾			2.2	1
	100	S704-K 100	GHS7045001R0637	111904¹⁾			2.2	1

¹⁾ bbn-Nr. 40 16779

E

selective
25.000 A

2



S0029b98

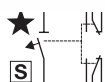

S0011b95

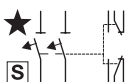

S0001B95



S0012b95



S700 E characteristic

Breakers of the S700 series are selective main circuit breakers for overcurrent protection in electrical installations. They have total selectivity to downstream mcb's and outstanding selectivity to upstream protective devices due to unique current limiting selectivity. Since S700 breakers are designed for overvoltage category IV and incorporate isolation function, they are predestinated for the use in any main distribution cabinet or meter board.

The S700 product range is completed by a broad range of accessories. With dedicated adapters, S700 products can be assembled on flat surfaces, on DIN rails or 40 mm busbar systems. To adapt S700 to different installations, they are available 1- to 4-pole with tripping characteristic E and K - optional with factory assembled auxiliary switch.

With factory assembled auxiliary switch (change-over contacts)

Number of poles	Rated current	Order details	Bbn 4012233	Price 1 piece	Price group	Weight 1 piece	Pack unit
In A	Type code	Order code	EAN			kg	pc.
1	16	S701-E 16+H2WR	GHS7010316 R0469	456609		0.65	3
	20	S701-E 20+H2WR	GHS7010316 R0489	456708		0.65	3
	25	S701-E 25+H2WR	GHS7010316 R0519	456807		0.65	3
	32	S701-E 32+H2WR	GHS7010316 R0529	456906		0.65	3
	35	S701-E 35+H2WR	GHS7010316 R0539	457002		0.65	3
	40	S701-E 40+H2WR	GHS7010316 R0559	457101		0.65	3
	50	S701-E 50+H2WR	GHS7010316 R0579	457200		0.65	3
	63	S701-E 63+H2WR	GHS7010316 R0599	457309		0.65	3
	80	S701-E 80+H2WR	GHS7010316 R0629	457408		0.65	3
2	16	S702-E 16+H2WR	GHS7020316 R0469	458405		1.2	2
	20	S702-E 20+H2WR	GHS7020316 R0489	458504		1.2	2
	25	S702-E 25+H2WR	GHS7020316 R0519	458603		1.2	2
	32	S702-E 32+H2WR	GHS7020316 R0529	458702		1.2	2
	35	S702-E 35+H2WR	GHS7020316 R0539	458801		1.2	2
	40	S702-E 40+H2WR	GHS7020316 R0559	458900		1.2	2
	50	S702-E 50+H2WR	GHS7020316 R0579	459006		1.2	2
	63	S702-E 63+H2WR	GHS7020316 R0599	459105		1.2	2
	80	S702-E 80+H2WR	GHS7020316 R0629	459204		1.2	2
3	16	S703-E 16+H2WR	GHS7030316 R0469	460200		1.75	1
	20	S703-E 20+H2WR	GHS7030316 R0489	460309		1.75	1
	25	S703-E 25+H2WR	GHS7030316 R0519	460408		1.75	1
	32	S703-E 32+H2WR	GHS7030316 R0529	460507		1.75	1
	35	S703-E 35+H2WR	GHS7030316 R0539	460606		1.75	1
	40	S703-E 40+H2WR	GHS7030316 R0559	460705		1.75	1
	50	S703-E 50+H2WR	GHS7030316 R0579	460804		1.75	1
	63	S703-E 63+H2WR	GHS7030316 R0599	460903		1.75	1
	80	S703-E 80+H2WR	GHS7030316 R0629	461009		1.75	1
4	16	S704-E 16+H2WR	GHS7040316 R0469	462006		2.3	1
	20	S704-E 20+H2WR	GHS7040316 R0489	462105		2.3	1
	25	S704-E 25+H2WR	GHS7040316 R0519	462204		2.3	1
	32	S704-E 32+H2WR	GHS7040316 R0529	462303		2.3	1
	35	S704-E 35+H2WR	GHS7040316 R0539	462402		2.3	1
	40	S704-E 40+H2WR	GHS7040316 R0559	462501		2.3	1
	50	S704-E 50+H2WR	GHS7040316 R0579	462600		2.3	1
	63	S704-E 63+H2WR	GHS7040316 R0599	462709		2.3	1
	80	S704-E 80+H2WR	GHS7040316 R0629	462808		2.3	1
100	S704-E 100+H2WR	GHS7040316 R0639	462907		2.3	1	

K

selective
25.000 A



S0029b98

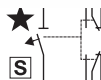

S0011b95



S0001b95

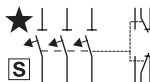

S0012b95



S700 K characteristic

Breakers of the S700 series are selective main circuit breakers for overcurrent protection in electrical installations. They have total selectivity to downstream mcb's and outstanding selectivity to upstream protective devices due to unique current limiting selectivity. Since S700 breakers are designed for overvoltage category IV and incorporate isolation function, they are predestinated for the use in any main distribution cabinet or meter board.

The S700 product range is completed by a broad range of accessories. With dedicated adapters, S700 products can be assembled on flat surfaces, on DIN rails or 40 mm busbar systems. To adapt S700 to different installations, they are available 1- to 4-pole with tripping characteristic E and K - optional with factory assembled auxiliary switch.

With factory assembled auxiliary switch (change-over contacts)

Number of poles	Rated current	Order details	Bbn 4012233	Price 1 piece	Price group	Weight 1 piece	Pack unit
In A	Type code	Order code	EAN	kg	pc.		
1	16	S701-K 16+H2WR	GHS7010316R0467	455800		0.65	3
	20	S701-K 20+H2WR	GHS7010316R0487	455909		0.65	3
	25	S701-K 25+H2WR	GHS7010316R0517	456005		0.65	3
	35	S701-K 35+H2WR	GHS7010316R0537	456104		0.65	3
	40	S701-K 40+H2WR	GHS7010316R0557	456203		0.65	3
	50	S701-K 50+H2WR	GHS7010316R0577	456302		0.65	3
	63	S701-K 63+H2WR	GHS7010316R0597	456401		0.65	3
	80	S701-K 80+H2WR	GHS7010316R0627	499651		0.65	3
2	16	S702-K 16+H2WR	GHS7020316R0467	457606		1.2	2
	20	S702-K 20+H2WR	GHS7020316R0487	457705		1.2	2
	25	S702-K 25+H2WR	GHS7020316R0517	457804		1.2	2
	35	S702-K 35+H2WR	GHS7020316R0537	457903		1.2	2
	40	S702-K 40+H2WR	GHS7020316R0557	458009		1.2	2
	50	S702-K 50+H2WR	GHS7020316R0577	458108		1.2	2
	63	S702-K 63+H2WR	GHS7020316R0597	458207		1.2	2
	80	S702-K 80+H2WR	GHS7020316R0627	499750		1.2	2
3	16	S703-K 16+H2WR	GHS7030316R0467	459402		1.75	1
	20	S703-K 20+H2WR	GHS7030316R0487	459501		1.75	1
	25	S703-K 25+H2WR	GHS7030316R0517	459600		1.75	1
	35	S703-K 35+H2WR	GHS7030316R0537	459709		1.75	1
	40	S703-K 40+H2WR	GHS7030316R0557	459808		1.75	1
	50	S703-K 50+H2WR	GHS7030316R0577	459907		1.75	1
	63	S703-K 63+H2WR	GHS7030316R0597	460002		1.75	1
	80	S703-K 80+H2WR	GHS7030316R0627	499774		1.75	1
4	16	S704-K 16+H2WR	GHS7040316R0467	461207		2.3	1
	20	S704-K 20+H2WR	GHS7040316R0487	461306		2.3	1
	25	S704-K 25+H2WR	GHS7040316R0517	461405		2.3	1
	35	S704-K 35+H2WR	GHS7040316R0537	461504		2.3	1
	40	S704-K 40+H2WR	GHS7040316R0557	461603		2.3	1
	50	S704-K 50+H2WR	GHS7040316R0577	461702		2.3	1
	63	S704-K 63+H2WR	GHS7040316R0597	461801		2.3	1
	80	S704-K 80+H2WR	GHS7040316R0627	499798		2.3	1
100	S704-K 100+H2WR	GHS7040316R0637	499804		2.3	1	



Auxiliary switch

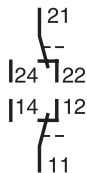

WT63 characteristic

WT63 is a short-circuit current limiter for 690 V AC applications.

In combination with other ABB devices WT63 offers smart solutions for coordinated motor protection according to IEC/EN 60947-4-1. As a main limiting device, WT63 can increase the short-circuit breaking capability for several groups of motor circuits to high values at 690 V AC. For further information according to selection and installation see the coordination table.

Number of poles	Rated current In A	Order details	Order code	Bbn 4016779	Price 1 piece	Price group	Weight 1 piece kg	Pack unit pc.
3	63	WT63-3	2CDH103012R0599	510677			1.65	1

with factory assembled auxiliary switch (change-over contacts)

3	63	WT63-3 HS	2CDH103816R0599	510684			1.75	1
---	----	------------------	-----------------	---------------	--	--	------	---

terminal cover (2 per pole mandatory)

		S700 KA 1	GHS7001903R0001	520203¹⁾			0.001	6
--	--	------------------	-----------------	----------------------------	--	--	-------	---

¹⁾ bbn-Nr. 40 12233

Motor starter combinations acc. to IEC/EN 60947-4-1
690 V AC, 35 kA, type 2, normal start-up

Motor		Current limiter	short-circuit protection		contactor		overload protection		wiring
Rated output [kW]	Rated current [A]		manual motor starter	tripping current [A]	Type	safety clearance [mm]	Type	current setting range [A]	WT63-MMS [mm ²]
0.37	0.61	WT63-3 or WT63-3 HS	MS/MO 325-1.0	11.50	A9	15	TA 25 DU 1.0	0.63-1.0	max. 16
1.5	2.08		MS/MO 325-2.5	28.75	A12	15	TA 25 DU 2.4	1.7-2.4	max. 16
1.1	2.36		MS/MO 325-2.5	28.75	A12	15	TA 25 DU 3.1	2.3-3.1	max. 16
3	3.6		MS/MO 325-4.0	40.00	A12	15	TA 25 DU 4.0	2.8-4.0	max. 16
4	4.97		MS/MO 325-6.3	78.75	A26	15	TA 25 DU 6.5	4.5-6.5	max. 16
7.5	8.7		MS/MO 325-12.5	187.50	A26	15	TA 25 DU 11	7.5-11	max. 16

For further combinations please contact the manufacturer.

Application notes

- WT63 may only be used for motor starter combinations confirmed by the manufacturer
- Max. no. of motor groups to be protected by WT63: 5
- The wiring between WT63 and MMS has to be short-circuit proof
- WT63 has to be installed with fitted terminal covers (factory assembled)
- The max. total operating current of WT63 has to be limited to 63 A, the max. total start-up current shall not exceed 450 A

For more details see separate product brochure.



TECHNICAL FEATURES		S800S			
Characteristics available		B, C, D	K	KM	UCB, UCK
Max. rated continuous current I_n	[A]	6...125	6...125	20...80	10...125
Poles		1...4	1...4	3	1...4
Rated operating voltage U_e					
(AC) 50/60Hz	[V]	400/690	400/690	400/690	-
(DC)/pole	[V]	max. 125	max. 125	max. 125	250
Rated insulation voltage U_i	[V]	690	690	690	250 ①
Rated impulse withstand voltage U_{imp}	[kV]	8	8	8	8
Ultimate short-circuit breaking capacity I_{cu} in accordance with IEC 60947-2					
(AC) 50/60Hz 240/415V	[kA]	50	50	50	-
(AC) 50/60Hz 254/440V	[kA]	30	30	30	-
(AC) 50/60Hz 289/500V (up to 80A)	[kA]	15	15	15	-
(AC) 50/60Hz 289/500V (100...125A)	[kA]	10	10	10	-
(AC) 50/60Hz 400/690V (up to 80A)	[kA]	6	6	6	-
(AC) 50/60Hz 400/690V (100...125A)	[kA]	4.5	4.5	4.5	-
(DC) 125V (1-pole)	[kA]	30	30	-	-
(DC) 250V (1-pole)	[kA]	-	-	-	50
(DC) 250V (2-pole)	[kA]	30	30	-	-
(DC) 375V (3-pole)	[kA]	30	30	30	-
(DC) 500V (2-pole)	[kA]	-	-	-	50
(DC) 500V (4-pole)	[kA]	30	30	-	-
(DC) 750V (3-pole)	[kA]	-	-	-	50
(DC) 750V (4-pole)	[kA]	-	-	-	50
Rated short-circuit breaking capacity I_{cn} EN 60898-1					
(AC) 50/60Hz 240/415V (up to 80A)	[kA]	25	-	-	-
Service short-circuit breaking capacity I_{cs} in accordance with IEC 60947-2					
(AC) 50/60Hz 240/415V	[kA]	40	40	40	-
(AC) 50/60Hz 254/440V (up to 80A)	[kA]	22.5	22.5	22.5	-
(AC) 50/60Hz 254/440V (100...125A)	[kA]	15	15	15	-
(AC) 50/60Hz 289/500V (up to 63A)	[kA]	11	11	11	-
(AC) 50/60Hz 289/500V (80A)	[kA]	8	8	8	-
(AC) 50/60Hz 289/500V (100...125A)	[kA]	5	5	5	-
(AC) 50/60Hz 400/690V (up to 80A)	[kA]	4	4	4	-
(AC) 50/60Hz 400/690V (100...125A)	[kA]	3	3	3	-
(DC) 125V (1-pole)	[kA]	30	30	-	-
(DC) 250V (1-pole)	[kA]	-	-	-	50
(DC) 250V (2-pole)	[kA]	30	30	-	-
(DC) 375V (3-pole)	[kA]	30	30	30	-
(DC) 500V (2-pole)	[kA]	-	-	-	50
(DC) 500V (4-pole)	[kA]	30	30	-	-
(DC) 750V (3-pole)	[kA]	-	-	-	50
(DC) 750V (4-pole)	[kA]	-	-	-	50
Service short-circuit breaking capacity I_{cs} in accordance with EN 60898-1					
(AC) 50/60Hz 240/415V (up to 80A)	[kA]	12.5	-	-	-
Rated frequency	[Hz]	50/60, (16 2/3)	50/60, (16 2/3)	50/60	-
Mounting position					
Disconnecter properties according to IEC 60947-2					
Standards					
		EN 60898-1	-	-	-
Connections CU (6...125A)	[mm ²]	1...50 strand 1...70 cable	1...50 strand 1...70 cable	1...50 strand 1...70 cable	1...50 strand 1...70 cable
Tightening torque	[Nm]	min. 3 / max. 4			
AC/DC supply					
Mounting on DIN top hat rail					
Permissible ambient temperature for operations					
Storage temperature	[°C]	-25...+60			
Type of protection					
Classification in accordance with NF-16-101, NF16-102					
Resistance to vibration					
IP20, IP40 (only actuation side)					
I3F2					
IEC 60068-2-27; IEC 60068-2; EN 61373 Cat.1/class B					

① DC/pole



TECHNICAL FEATURES		S800N
Characteristics available		B, C, D
Max. rated continuous current I_n	[A]	10...125
Poles		1...4
Rated operating voltage U_e		
(AC) 50/60Hz	[V]	400/690
(DC)/pole	[V]	max. 125
Rated insulation voltage U_i	[V]	690
Rated impulse withstand voltage U_{imp}	[kV]	8
Ultimate short-circuit breaking capacity I_{cu} in accordance with IEC 60947-2		
(AC) 50/60Hz 240/415V	[kA]	36
(AC) 50/60Hz 254/440V	[kA]	20
(AC) 50/60Hz 289/500V	[kA]	10
(AC) 50/60Hz 400/690V	[kA]	4.5
(DC) 125V (1-pole)	[kA]	20
(DC) 250V (2-poles)	[kA]	20
(DC) 375V (3-poles)	[kA]	20
(DC) 500V (4-poles)	[kA]	20
Rated short-circuit breaking capacity I_{cn} EN 60898-1 (AC) 50/60Hz 240/415V (up to 80A)	[kA]	20
Service short-circuit breaking capacity I_{cs} in accordance with IEC 60947-2		
(AC) 50/60Hz 240/415V	[kA]	30
(AC) 50/60Hz 254/440V (10...80A)	[kA]	15
(AC) 50/60Hz 254/440V (100...125A)	[kA]	10
(AC) 50/60Hz 289/500V (10...63A)	[kA]	8
(AC) 50/60Hz 289/500V (80...125A)	[kA]	5
(AC) 50/60Hz 400/690V	[kA]	3
(DC) 125V (1-pole)	[kA]	20
(DC) 250V (2-pole)	[kA]	20
(DC) 375V (3-pole)	[kA]	20
(DC) 500V (4-pole)	[kA]	20
Service short-circuit breaking capacity I_{cs} in accordance with EN 60898-1		
(AC) 50/60Hz 240/415V (up to 80A)	[kA]	10
Rated frequency	[Hz]	50/60
Mounting position		any
Disconnecter properties according to IEC 60947-2		yes
Standards		IEC 60947-2, EN 60898-1
Connections CU (10...125A)	[mm ²]	1...50 strand 1...70 cable
Tightening torque	[Nm]	min. 3 / max. 4
Supply AC		any
Mounting on DIN top hat rail		EN 60715
Permissible ambient temperature for operations	[°C]	-25...+60
Storage temperature	[°C]	-40...+70
Type of protection		IP20, IP40 (only actuation side)
Classification in accordance with NF-16-101, NF16-102		I3F2



TECHNICAL FEATURES		S800C
Characteristics available		B, C, D, K
Max. rated continuous current I_n	[A]	10...125
Poles		1...4
Rated operating voltage U_e		
(AC) 50/60Hz	[V]	254/440
(DC)/pole	[V]	max. 125
Rated insulation voltage U_i	[V]	500
Rated impulse withstand voltage U_{imp}	[kV]	8
Ultimate short-circuit breaking capacity I_{cu} in accordance with IEC 60947-2		
(AC) 50/60Hz 240/415V	[kA]	25
(AC) 50/60Hz 254/440V	[kA]	15
(DC) 125V (1-pole)	[kA]	10
(DC) 250V (2-pole)	[kA]	10
(DC) 375V (3-pole)	[kA]	10
(DC) 500V (4-pole)	[kA]	10
Rated short-circuit breaking capacity I_{cn} EN 60898-1		
(AC) 50/60Hz 230/400V (characteristic: B, C, D ①)	[kA]	15
Service short-circuit breaking capacity I_{cs} in accordance with IEC 60947-2		
(AC) 50/60Hz 240/415V	[kA]	18
(AC) 50/60Hz 254/440V	[kA]	10
(DC) 125V (1-pole)	[kA]	10
(DC) 250V (2-pole)	[kA]	10
(DC) 375V (3-pole)	[kA]	10
(DC) 500V (4-pole)	[kA]	10
Service short-circuit breaking capacity I_{cs} in accordance with EN 60898-1		
(AC) 50/60Hz 230/400V (characteristic: B, C, D ①)	[kA]	7.5
Rated frequency	[Hz]	50/60
Mounting position		any
Disconnecter properties according to IEC 60947-2		yes
Standards		IEC 60947-2 EN 60898 (B, C, D)
Connections CU (10...125A)	[mm ²]	1...50 strand 1...70 cable
Tightening torque	[Nm]	min. 3 / max. 4
Supply AC		any
Mounting on DIN top hat rail		EN 60715
Permissible ambient temperature for operations	[°C]	-25...+60
Storage temperature	[°C]	-40...+70
Type of protection		IP20
Classification in accordance with NF-16-101, NF16-102		IP40 (only actuation side) I3F2

① (DC) ≤ 100A; S800C-D125 only IEC 60947-2

2



TECHNICAL FEATURES	S800U-Z	S800U-K
Standards	UL489, CSA 22.2 No. 5-02, IEC 60947-2	
Characteristics available	Z ^①	K ^②
Rated current I_n	[A]	10...100
Poles		1...4
Rated operating voltage U_e (AC) 50/60Hz	[V]	240
Rated interrupting in accordance with UL489		
1-pole	[kA]	30
2...4-pole	[kA]	50
Ultimate short-circuit breaking capacity I_{cu} in accordance with IEC 60947-2		
(AC) 50/60 Hz 240/415V 1-pole	[kA]	30
(AC) 50/60 Hz 240/415V 2 ...4-pole	[kA]	50
Service short-circuit capacity I_{cs} in accordance with IEC 60947-2		
(AC) 50/60 Hz 240/415V 1-pole	[kA]	25
(AC) 50/60 Hz 240/415V 2 ...4-pole	[kA]	40
Conductor type	Single conductor copper only	
Wire range 10...100A	8-1AWG	
Tightening torque	31 in.lbs. (3.5Nm)	
Mounting position	any	
Permissible ambient temperature for operations	[°C]	-25...+60
Type of protection	IP20	
	IP40 (only actuation side)	
Contacts	cadmium free	
Certifications	UL listed circuit breaker (File 312425)	
Standards	CSA 22.2 No. 5-02	

① Magnetic release 4xI_n
 ② Magnetic release 8xI_n



TECHNICAL FEATURES	S800PV-S		S800PV-M	
Characteristics available	PV-S		-	
Max. rated continuous current I_n	[A]	10...125	32, 63, 125	
Poles		2...4	2...4	
Rated operating voltage U_e			-	
(AC) 50/60Hz	[V]		-	
(DC)/pole	[V]		400 ①	
(DC)/2 pole	[V]	10...80 A	100, 125 A	32, 63, 125 A
(DC)/3 pole	[V]	800	600	800
(DC)/4 pole	[V]	1200	1000	1200
Rated insulation voltage U_i	[V]	1200	1200	1200
Rated impulse withstand voltage U_{imp}	[kV]			1500
Ultimate short-circuit breaking capacity I_{cu} in accordance with IEC 60947-2				8
(DC) 800V (2-pole)	[kA]	5		-
(DC) 1200V (3-pole)	[kA]	5		-
(DC) 1200V (4-pole)	[kA]	5		-
Service short-circuit breaking capacity I_{cs} in accordance with IEC 60947-2				
(DC) 800V (2-pole)	[kA]	5		-
(DC) 1200V (3-pole)	[kA]	5		-
(DC) 1200V (4-pole)	[kA]	5		-
Rated short-time withstand current I_{cw} in accordance with IEC 60947-3				
(DC) 800V (2-pole)	[kA]	-		1.5
(DC) 1200V (3-pole)	[kA]	-		1.5
(DC) 1200V (4-pole)	[kA]	-		1.5
Rated short-circuit making capacity I_{cm} in accordance with IEC 60947-3				
(DC) 800V (2-pole)	[kA]	-		0.5
(DC) 1200V (3-pole)	[kA]	-		0.5
(DC) 1200V (4-pole)	[kA]	-		0.5
Mounting position				any
Disconnecter properties according to IEC 60947-2				yes
Standards		IEC 60947-2		IEC 60947-3
Connections CU (10...125A)	[mm ²]		1...50 strand 1...70 cable	
Tightening torque	[Nm]		min. 3 / max. 4	
DC supply				any
Mounting on DIN top hat rail				EN 60715
Permissible ambient temperature for operations	[°C]			-25...+60
Storage temperature	[°C]			-40...+70
Type of protection				IP20
				IP40 (only actuation side)
Resistance to vibration		IEC 60068-2-6;		EN 61373 Cat. 1/Class B
Utilisation category		A		DC-21A
Pollution degree			2	
Overvoltage category			III	

① 4-pole 1200VDC

B



S800S-B characteristic

Function: protection and control of the circuits against overloads and short-circuits when a high breaking capacity is required; protection for people and big length cables in TN and IT systems; very useful when selectivity is needed vs an MCCB or back-up vs other MCBs wired downstream.

Applications: commercial and industrial.

Standard: IEC/EN 60898, IEC/EN 60947-2

Icn=25 kA

Icu=50 kA

Number of poles	Rated current	Order details		Bbn 7612271	Price 1 piece	Price group	Weight 1 piece	Pack unit
In A	Type code	Order code	EAN			kg	pc.	
1	6	S801S-B6*	2CCS861001R0065	408107		0.245	1	
	8	S801S-B8*	2CCS861001R0085	411329		0.245	1	
	10	S801S-B10	2CCS861001R0105	200008		0.245	1	
	13	S801S-B13	2CCS861001R0135	200015		0.245	1	
	16	S801S-B16	2CCS861001R0165	200022		0.245	1	
	20	S801S-B20	2CCS861001R0205	200039		0.245	1	
	25	S801S-B25	2CCS861001R0255	200046		0.245	1	
	32	S801S-B32	2CCS861001R0325	200053		0.245	1	
	40	S801S-B40	2CCS861001R0405	200060		0.245	1	
	50	S801S-B50	2CCS861001R0505	200077		0.245	1	
	63	S801S-B63	2CCS861001R0635	200084		0.245	1	
	80	S801S-B80	2CCS861001R0805	200091		0.245	1	
	100	S801S-B100	2CCS861001R0825	200107		0.245	1	
125	S801S-B125	2CCS861001R0845	200114		0.245	1		
2	6	S802S-B6*	2CCS862001R0065	408114		0.49	1	
	8	S802S-B8*	2CCS862001R0085	411336		0.49	1	
	10	S802S-B10	2CCS862001R0105	200121		0.49	1	
	13	S802S-B13	2CCS862001R0135	200138		0.49	1	
	16	S802S-B16	2CCS862001R0165	200145		0.49	1	
	20	S802S-B20	2CCS862001R0205	200152		0.49	1	
	25	S802S-B25	2CCS862001R0255	200169		0.49	1	
	32	S802S-B32	2CCS862001R0325	200176		0.49	1	
	40	S802S-B40	2CCS862001R0405	200183		0.49	1	
	50	S802S-B50	2CCS862001R0505	200190		0.49	1	
	63	S802S-B63	2CCS862001R0635	200206		0.49	1	
	80	S802S-B80	2CCS862001R0805	200213		0.49	1	
	100	S802S-B100	2CCS862001R0825	200220		0.49	1	
125	S802S-B125	2CCS862001R0845	200237		0.49	1		

* Standard: EN/IEC 60947-2

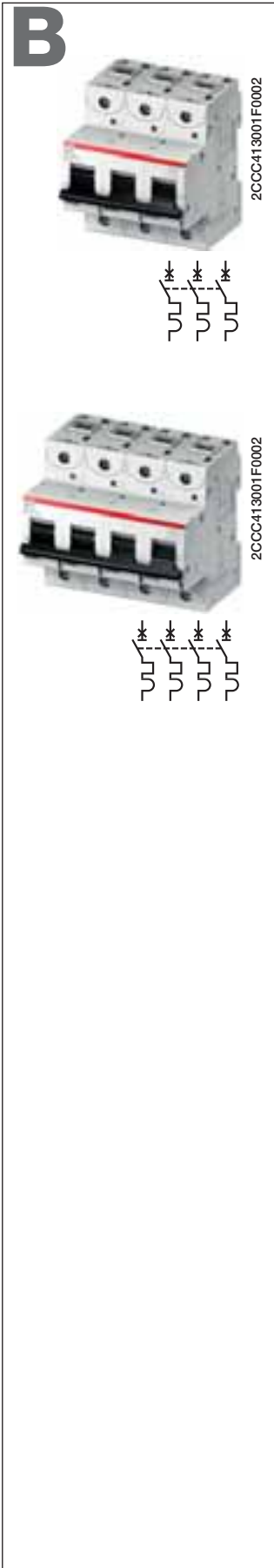

3	6	S803S-B6*	2CCS863001R0065	408121	0.735	1
	8	S803S-B8*	2CCS863001R0085	411343	0.735	1
	10	S803S-B10	2CCS863001R0105	200244	0.735	1
	13	S803S-B13	2CCS863001R0135	200251	0.735	1
	16	S803S-B16	2CCS863001R0165	200268	0.735	1
	20	S803S-B20	2CCS863001R0205	200275	0.735	1
	25	S803S-B25	2CCS863001R0255	200282	0.735	1
	32	S803S-B32	2CCS863001R0325	200299	0.735	1
	40	S803S-B40	2CCS863001R0405	200305	0.735	1
	50	S803S-B50	2CCS863001R0505	200312	0.735	1
	63	S803S-B63	2CCS863001R0635	200329	0.735	1
	80	S803S-B80	2CCS863001R0805	200336	0.735	1
100	S803S-B100	2CCS863001R0825	200343	0.735	1	
125	S803S-B125	2CCS863001R0845	200350	0.735	1	

4	6	S804S-B6*	2CCS864001R0065	408138	0.98	1
	8	S804S-B8*	2CCS864001R0085	411350	0.98	1
	10	S804S-B10	2CCS864001R0105	200367	0.98	1
	13	S804S-B13	2CCS864001R0135	200374	0.98	1
	16	S804S-B16	2CCS864001R0165	200381	0.98	1
	20	S804S-B20	2CCS864001R0205	200398	0.98	1
	25	S804S-B25	2CCS864001R0255	200404	0.98	1
	32	S804S-B32	2CCS864001R0325	200411	0.98	1
	40	S804S-B40	2CCS864001R0405	200428	0.98	1
	50	S804S-B50	2CCS864001R0505	200435	0.98	1
	63	S804S-B63	2CCS864001R0635	200442	0.98	1
	80	S804S-B80	2CCS864001R0805	200459	0.98	1
	100	S804S-B100	2CCS864001R0825	200466	0.98	1
	125	S804S-B125	2CCS864001R0845	200473	0.98	1

* Standard: EN/IEC 60947-2

B

2



S800S-B characteristic

Function: protection and control of the circuits against overloads and short-circuits when a high breaking capacity is required; protection for people and big length cables in TN and IT systems; very useful when selectivity is needed vs an MCCB or back-up vs other MCBs wired downstream.

Applications: commercial and industrial.

Standard: IEC/EN 60898, IEC/EN 60947-2

Icn=25 kA

Icu=50 kA

Number of poles	Rated current	Order details	Bbn	Price 1 piece	Price group	Weight 1 piece	Pack unit
In A	Type code	Order code	EAN			kg	pc.
1	6	S801S-B6-R*	2CCS861002R0065	408268		0,245	1
	8	S801S-B8-R*	2CCS861002R0085	411480		0,245	1
	10	S801S-B10-R	2CCS861002R0105	209636		0,245	1
	13	S801S-B13-R	2CCS861002R0135	209643		0,245	1
	16	S801S-B16-R	2CCS861002R0165	209650		0,245	1
	20	S801S-B20-R	2CCS861002R0205	209667		0,245	1
	25	S801S-B25-R	2CCS861002R0255	209674		0,245	1
	32	S801S-B32-R	2CCS861002R0325	209681		0,245	1
	40	S801S-B40-R	2CCS861002R0405	206826		0,245	1
	50	S801S-B50-R	2CCS861002R0505	206833		0,245	1
	63	S801S-B63-R	2CCS861002R0635	206840		0,245	1
	80	S801S-B80-R	2CCS861002R0805	206857		0,245	1
	100	S801S-B100-R	2CCS861002R0825	206864		0,245	1
	125	S801S-B125-R	2CCS861002R0845	206871		0,245	1
2	6	S802S-B6-R*	2CCS862002R0065	408275		0,49	1
	8	S802S-B8-R*	2CCS862002R0085	411497		0,49	1
	10	S802S-B10-R	2CCS862002R0105	209698		0,49	1
	13	S802S-B13-R	2CCS862002R0135	209704		0,49	1
	16	S802S-B16-R	2CCS862002R0165	209711		0,49	1
	20	S802S-B20-R	2CCS862002R0205	209728		0,49	1
	25	S802S-B25-R	2CCS862002R0255	209735		0,49	1
	32	S802S-B32-R	2CCS862002R0325	209742		0,49	1
	40	S802S-B40-R	2CCS862002R0405	206888		0,49	1
	50	S802S-B50-R	2CCS862002R0505	206895		0,49	1
	63	S802S-B63-R	2CCS862002R0635	206901		0,49	1
	80	S802S-B80-R	2CCS862002R0805	206918		0,49	1
	100	S802S-B100-R	2CCS862002R0825	206925		0,49	1
	125	S802S-B125-R	2CCS862002R0845	206932		0,49	1

* Standard: EN/IEC 60947-2

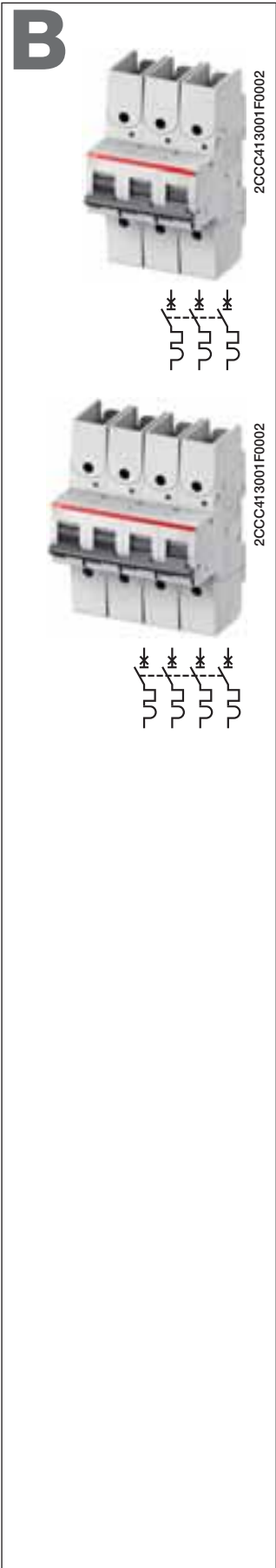

3	6	S803S-B6-R*	2CCS863002R0065	408282	0,735	1
	8	S803S-B8-R*	2CCS863002R0085	411503	0,735	1
	10	S803S-B10-R	2CCS863002R0105	209759	0,735	1
	13	S803S-B13-R	2CCS863002R0135	209766	0,735	1
	16	S803S-B16-R	2CCS863002R0165	209773	0,735	1
	20	S803S-B20-R	2CCS863002R0205	209780	0,735	1
	25	S803S-B25-R	2CCS863002R0255	209797	0,735	1
	32	S803S-B32-R	2CCS863002R0325	209803	0,735	1
	40	S803S-B40-R	2CCS863002R0405	206949	0,735	1
	50	S803S-B50-R	2CCS863002R0505	206956	0,735	1
	63	S803S-B63-R	2CCS863002R0635	206963	0,735	1
	80	S803S-B80-R	2CCS863002R0805	206970	0,735	1
	100	S803S-B100-R	2CCS863002R0825	206987	0,735	1
125	S803S-B125-R	2CCS863002R0845	206994	0,735	1	
4	6	S804S-B6-R*	2CCS864002R0065	408299	0,98	1
	8	S804S-B8-R*	2CCS864002R0085	411510	0,98	1
	10	S804S-B10-R	2CCS864002R0105	209810	0,98	1
	13	S804S-B13-R	2CCS864002R0135	209827	0,98	1
	16	S804S-B16-R	2CCS864002R0165	209834	0,98	1
	20	S804S-B20-R	2CCS864002R0205	209841	0,98	1
	25	S804S-B25-R	2CCS864002R0255	209858	0,98	1
	32	S804S-B32-R	2CCS864002R0325	209865	0,98	1
	40	S804S-B40-R	2CCS864002R0405	207007	0,98	1
	50	S804S-B50-R	2CCS864002R0505	207014	0,98	1
	63	S804S-B63-R	2CCS864002R0635	207021	0,98	1
	80	S804S-B80-R	2CCS864002R0805	207038	0,98	1
	100	S804S-B100-R	2CCS864002R0825	207045	0,98	1
	125	S804S-B125-R	2CCS864002R0845	207052	0,98	1

* Standard: EN/IEC 60947-2

C



S800S-C characteristic

Function: protection and control of the circuits against overloads and short-circuits when a high breaking capacity is required; protection for resistive and inductive loads with low inrush current; very useful when selectivity is needed vs an MCCB or back-up vs other MCBs wired downstream.

Applications: commercial and industrial.

Standard: IEC/EN 60898, IEC/EN 60947-2

Icn=25 kA

Icu=50 kA

Number of poles	Rated current In A	Order details		Bbn 7612271	Price 1 piece	Price group	Weight 1 piece kg	Pack unit pc.
		Type code	Order code					
1	6	S801S-C6*	2CCS861001R0064	408145			0.245	1
	8	S801S-C8*	2CCS861001R0084	411367			0.245	1
	10	S801S-C10	2CCS861001R0104	200480			0.245	1
	13	S801S-C13	2CCS861001R0134	200497			0.245	1
	16	S801S-C16	2CCS861001R0164	200503			0.245	1
	20	S801S-C20	2CCS861001R0204	200510			0.245	1
	25	S801S-C25	2CCS861001R0254	200527			0.245	1
	32	S801S-C32	2CCS861001R0324	200534			0.245	1
	40	S801S-C40	2CCS861001R0404	200541			0.245	1
	50	S801S-C50	2CCS861001R0504	200558			0.245	1
	63	S801S-C63	2CCS861001R0634	200565			0.245	1
	80	S801S-C80	2CCS861001R0804	200572			0.245	1
	100	S801S-C100	2CCS861001R0824	200589			0.245	1
125	S801S-C125	2CCS861001R0844	200596			0.245	1	
2	6	S802S-C6*	2CCS862001R0064	408152			0.49	1
	8	S802S-C8*	2CCS862001R0084	411374			0.49	1
	10	S802S-C10	2CCS862001R0104	200602			0.49	1
	13	S802S-C13	2CCS862001R0134	200619			0.49	1
	16	S802S-C16	2CCS862001R0164	200626			0.49	1
	20	S802S-C20	2CCS862001R0204	200633			0.49	1
	25	S802S-C25	2CCS862001R0254	200640			0.49	1
	32	S802S-C32	2CCS862001R0324	200657			0.49	1
	40	S802S-C40	2CCS862001R0404	200664			0.49	1
	50	S802S-C50	2CCS862001R0504	200671			0.49	1
	63	S802S-C63	2CCS862001R0634	200688			0.49	1
	80	S802S-C80	2CCS862001R0804	200695			0.49	1
	100	S802S-C100	2CCS862001R0824	200701			0.49	1
125	S802S-C125	2CCS862001R0844	200718			0.49	1	

* Standard: EN/IEC 60947-2

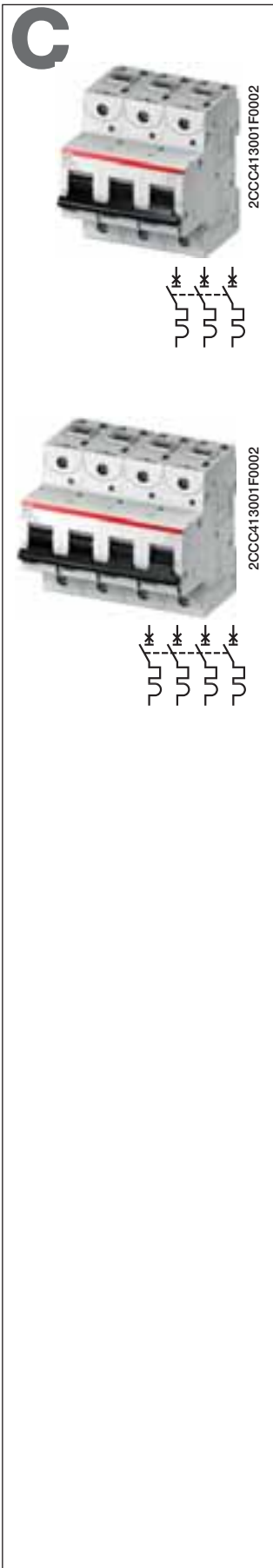

3	6	S803S-C6*	2CCS863001R0064	408169	0.735	1
	8	S803S-C8*	2CCS863001R0084	411381	0.735	1
	10	S803S-C10	2CCS863001R0104	200725	0.735	1
	13	S803S-C13	2CCS863001R0134	200732	0.735	1
	16	S803S-C16	2CCS863001R0164	200749	0.735	1
	20	S803S-C20	2CCS863001R0204	200756	0.735	1
	25	S803S-C25	2CCS863001R0254	200763	0.735	1
	32	S803S-C32	2CCS863001R0324	200770	0.735	1
	40	S803S-C40	2CCS863001R0404	200787	0.735	1
	50	S803S-C50	2CCS863001R0504	200794	0.735	1
	63	S803S-C63	2CCS863001R0634	200800	0.735	1
	80	S803S-C80	2CCS863001R0804	200817	0.735	1
100	S803S-C100	2CCS863001R0824	200824	0.735	1	
125	S803S-C125	2CCS863001R0844	200831	0.735	1	
4	6	S804S-C6*	2CCS864001R0064	408176	0.98	1
	8	S804S-C8*	2CCS864001R0084	411398	0.98	1
	10	S804S-C10	2CCS864001R0104	200848	0.98	1
	13	S804S-C13	2CCS864001R0134	200855	0.98	1
	16	S804S-C16	2CCS864001R0164	200862	0.98	1
	20	S804S-C20	2CCS864001R0204	200879	0.98	1
	25	S804S-C25	2CCS864001R0254	200886	0.98	1
	32	S804S-C32	2CCS864001R0324	200893	0.98	1
	40	S804S-C40	2CCS864001R0404	200909	0.98	1
	50	S804S-C50	2CCS864001R0504	200916	0.98	1
	63	S804S-C63	2CCS864001R0634	200923	0.98	1
	80	S804S-C80	2CCS864001R0804	200930	0.98	1
100	S804S-C100	2CCS864001R0824	200947	0.98	1	
125	S804S-C125	2CCS864001R0844	200954	0.98	1	

* Standard: EN/IEC 60947-2

C



S800S-C characteristic

Function: protection and control of the circuits against overloads and short-circuits when a high breaking capacity is required; protection for resistive and inductive loads with low inrush current; very useful when selectivity is needed vs an MCCB or back-up vs other MCBs wired downstream.

Applications: commercial and industrial.

Standard: IEC/EN 60947-2, IEC/EN 60898

Icn=25 kA

Icu=50 kA

Number of poles	Rated current In A	Order details Type code	Order code	Bbn	Price	Price group	Weight	Pack
				7612271	1 piece		1 piece	unit
				EAN			kg	pc.
1	6	S801S-C6-R*	2CCS861002R0064	408305			0,245	1
	8	S801S-C8-R*	2CCS861002R0084	411527			0,245	1
	10	S801S-C10-R	2CCS861002R0104	209872			0,245	1
	13	S801S-C13-R	2CCS861002R0134	209889			0,245	1
	16	S801S-C16-R	2CCS861002R0164	209896			0,245	1
	20	S801S-C20-R	2CCS861002R0204	209902			0,245	1
	25	S801S-C25-R	2CCS861002R0254	209919			0,245	1
	32	S801S-C32-R	2CCS861002R0324	209926			0,245	1
	40	S801S-C40-R	2CCS861002R0404	207069			0,245	1
	50	S801S-C50-R	2CCS861002R0504	207076			0,245	1
	63	S801S-C63-R	2CCS861002R0634	207083			0,245	1
	80	S801S-C80-R	2CCS861002R0804	207090			0,245	1
	100	S801S-C100-R	2CCS861002R0824	207106			0,245	1
125	S801S-C125-R	2CCS861002R0844	207113			0,245	1	
2	6	S802S-C6-R*	2CCS862002R0064	408312			0,49	1
	8	S802S-C8-R*	2CCS862001R0084	411534			0,49	1
	10	S802S-C10-R	2CCS862002R0104	209933			0,49	1
	13	S802S-C13-R	2CCS862002R0134	209940			0,49	1
	16	S802S-C16-R	2CCS862002R0164	209957			0,49	1
	20	S802S-C20-R	2CCS862002R0204	209964			0,49	1
	25	S802S-C25-R	2CCS862002R0254	209971			0,49	1
	32	S802S-C32-R	2CCS862002R0324	209988			0,49	1
	40	S802S-C40-R	2CCS862002R0404	207120			0,49	1
	50	S802S-C50-R	2CCS862002R0504	207137			0,49	1
	63	S802S-C63-R	2CCS862002R0634	207144			0,49	1
	80	S802S-C80-R	2CCS862002R0804	207151			0,49	1
	100	S802S-C100-R	2CCS862002R0824	207168			0,49	1
125	S802S-C125-R	2CCS862002R0844	207175			0,49	1	

* Standard: EN/IEC 60947-2

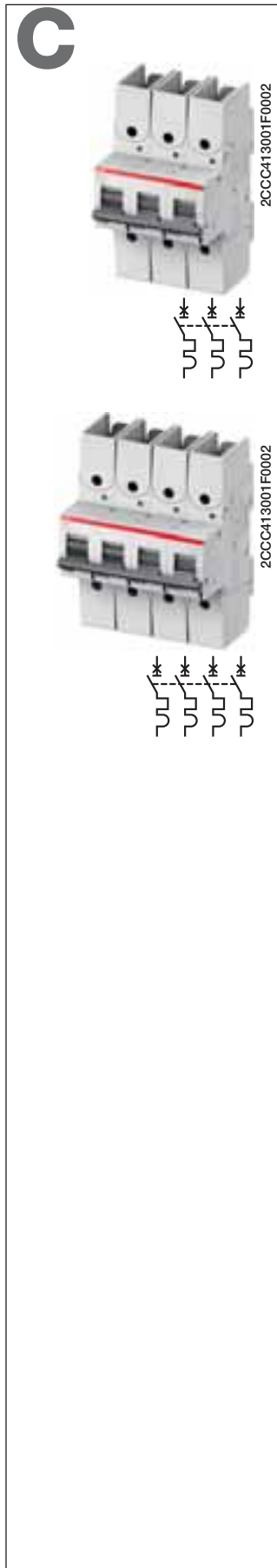

3	6	S803S-C6-R*	2CCS863002R0064	408329	0,735	1
	8	S803S-C8-R*	2CCS863002R0084	411541	0,735	1
	10	S803S-C10-R	2CCS863002R0104	209995	0,735	1
	13	S803S-C13-R	2CCS863002R0134	210007	0,735	1
	16	S803S-C16-R	2CCS863002R0164	210014	0,735	1
	20	S803S-C20-R	2CCS863002R0204	210021	0,735	1
	25	S803S-C25-R	2CCS863002R0254	210038	0,735	1
	32	S803S-C32-R	2CCS863002R0324	210045	0,735	1
	40	S803S-C40-R	2CCS863002R0404	207182	0,735	1
	50	S803S-C50-R	2CCS863002R0504	207199	0,735	1
	63	S803S-C63-R	2CCS863002R0634	207205	0,735	1
	80	S803S-C80-R	2CCS863002R0804	207212	0,735	1
	100	S803S-C100-R	2CCS863002R0824	207229	0,735	1
125	S803S-C125-R	2CCS863002R0844	207236	0,735	1	
4	6	S804S-C6-R*	2CCS864002R0064	408336	0,98	1
	8	S804S-C8-R*	2CCS864002R0084	411558	0,98	1
	10	S804S-C10-R	2CCS864002R0104	210052	0,98	1
	13	S804S-C13-R	2CCS864002R0134	210069	0,98	1
	16	S804S-C16-R	2CCS864002R0164	210076	0,98	1
	20	S804S-C20-R	2CCS864002R0204	210083	0,98	1
	25	S804S-C25-R	2CCS864002R0254	210090	0,98	1
	32	S804S-C32-R	2CCS864002R0324	210106	0,98	1
	40	S804S-C40-R	2CCS864002R0404	207243	0,98	1
	50	S804S-C50-R	2CCS864002R0504	207250	0,98	1
	63	S804S-C63-R	2CCS864002R0634	207267	0,98	1
	80	S804S-C80-R	2CCS864002R0804	207274	0,98	1
	100	S804S-C100-R	2CCS864002R0824	207281	0,98	1
125	S804S-C125-R	2CCS864002R0844	207298	0,98	1	

* Standard: EN/IEC 60947-2

D



S800S-D characteristic

Function: protection and control of the circuits against overloads and short-circuits when a high breaking capacity is required; protection for circuits which supply loads with high inrush current at the circuit closing (motors, LV / LV transformers, breakdown lamps); very useful when selectivity is needed vs an MCCB or back-up vs other MCBs wired downstream.

Applications: commercial and industrial.

Standard: IEC/EN 60898, IEC/EN 60947-2

Icn=25 kA

Icu=50 kA

Number of poles	Rated current In A	Order details Type code	Order code	Bbn 7612271 EAN	Price 1 piece	Price group	Weight 1 piece kg	Pack unit pc.
1	6	S801S-D6*	2CCS861001R0061	408183			0.245	1
	8	S801S-D8*	2CCS861001R0081	411404			0.245	1
	10	S801S-D10	2CCS861001R0101	200961			0.245	1
	13	S801S-D13	2CCS861001R0131	200978			0.245	1
	16	S801S-D16	2CCS861001R0161	200985			0.245	1
	20	S801S-D20	2CCS861001R0201	200992			0.245	1
	25	S801S-D25	2CCS861001R0251	201005			0.245	1
	32	S801S-D32	2CCS861001R0321	201012			0.245	1
	40	S801S-D40	2CCS861001R0401	201029			0.245	1
	50	S801S-D50	2CCS861001R0501	201036			0.245	1
	63	S801S-D63	2CCS861001R0631	201043			0.245	1
	80	S801S-D80	2CCS861001R0801	201050			0.245	1
	100	S801S-D100	2CCS861001R0821	201067			0.245	1
	125	S801S-D125	2CCS861001R0841	201074			0.245	1
2	6	S802S-D6*	2CCS862001R0061	408190			0.49	1
	8	S802S-D8*	2CCS862001R0081	411411			0.49	1
	10	S802S-D10	2CCS862001R0101	201081			0.49	1
	13	S802S-D13	2CCS862001R0131	201098			0.49	1
	16	S802S-D16	2CCS862001R0161	201104			0.49	1
	20	S802S-D20	2CCS862001R0201	201111			0.49	1
	25	S802S-D25	2CCS862001R0251	201128			0.49	1
	32	S802S-D32	2CCS862001R0321	201135			0.49	1
	40	S802S-D40	2CCS862001R0401	201142			0.49	1
	50	S802S-D50	2CCS862001R0501	201159			0.49	1
	63	S802S-D63	2CCS862001R0631	201166			0.49	1
	80	S802S-D80	2CCS862001R0801	201173			0.49	1
	100	S802S-D100	2CCS862001R0821	201180			0.49	1
	125	S802S-D125	2CCS862001R0841	201197			0.49	1

* Standard: EN/IEC 60947-2

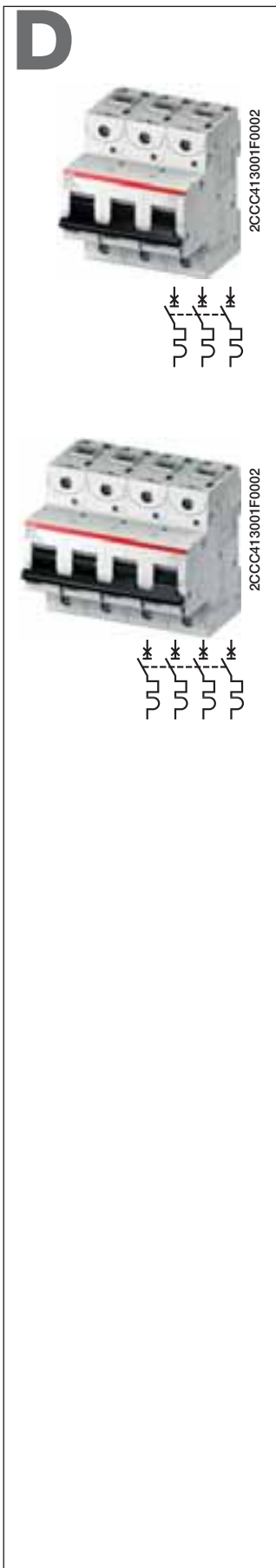

3	6	S803S-D6*	2CCS863001R0061	408206	0.735	1
	8	S803S-D8*	2CCS863001R0081	411428	0.735	1
	10	S803S-D10	2CCS863001R0101	201203	0.735	1
	13	S803S-D13	2CCS863001R0131	201210	0.735	1
	16	S803S-D16	2CCS863001R0161	201227	0.735	1
	20	S803S-D20	2CCS863001R0201	201234	0.735	1
	25	S803S-D25	2CCS863001R0251	201241	0.735	1
	32	S803S-D32	2CCS863001R0321	201258	0.735	1
	40	S803S-D40	2CCS863001R0401	201265	0.735	1
	50	S803S-D50	2CCS863001R0501	201272	0.735	1
	63	S803S-D63	2CCS863001R0631	201289	0.735	1
	80	S803S-D80	2CCS863001R0801	201296	0.735	1
	100	S803S-D100	2CCS863001R0821	201302	0.735	1
125	S803S-D125	2CCS863001R0841	201319	0.735	1	
4	6	S804S-D6*	2CCS864001R0061	408213	0.98	1
	8	S804S-D8*	2CCS864001R0081	411435	0.98	1
	10	S804S-D10	2CCS864001R0101	201326	0.98	1
	13	S804S-D13	2CCS864001R0131	201333	0.98	1
	16	S804S-D16	2CCS864001R0161	201340	0.98	1
	20	S804S-D20	2CCS864001R0201	201357	0.98	1
	25	S804S-D25	2CCS864001R0251	201364	0.98	1
	32	S804S-D32	2CCS864001R0321	201371	0.98	1
	40	S804S-D40	2CCS864001R0401	201388	0.98	1
	50	S804S-D50	2CCS864001R0501	201395	0.98	1
	63	S804S-D63	2CCS864001R0631	201401	0.98	1
	80	S804S-D80	2CCS864001R0801	201418	0.98	1
	100	S804S-D100	2CCS864001R0821	201425	0.98	1
125	S804S-D125	2CCS864001R0841	201432	0.98	1	

* Standard: EN/IEC 60947-2

D



S800S-D characteristic

Function: protection and control of the circuits against overloads and short-circuits when a high breaking capacity is required; protection for circuits which supply loads with high inrush current at the circuit closing (motors, LV / LV transformers, breakdown lamps); very useful when selectivity is needed vs an MCCB or back-up vs other MCBs wired downstream.

Applications: commercial and industrial.

Standard: IEC/EN 60947-2, IEC/EN 60898

Icn=25 kA

Icu=50 kA

Number of poles	Rated current In A	Order details Type code	Order code	Bbn	Price 1 piece	Price group	Weight 1 piece kg	Pack unit pc.
				7612271				
1	6	S801S-D6-R*	2CCS861002R0061	408343			0,245	1
	8	S801S-D8-R*	2CCS861002R0081	411565			0,245	1
	10	S801S-D10-R	2CCS861002R0101	210113			0,245	1
	13	S801S-D13-R	2CCS861002R0131	210120			0,245	1
	16	S801S-D16-R	2CCS861002R0161	210137			0,245	1
	20	S801S-D20-R	2CCS861002R0201	210144			0,245	1
	25	S801S-D25-R	2CCS861002R0251	210151			0,245	1
	32	S801S-D32-R	2CCS861002R0321	210168			0,245	1
	40	S801S-D40-R	2CCS861002R0401	207304			0,245	1
	50	S801S-D50-R	2CCS861002R0501	207311			0,245	1
	63	S801S-D63-R	2CCS861002R0631	207328			0,245	1
	80	S801S-D80-R	2CCS861002R0801	207335			0,245	1
	100	S801S-D100-R	2CCS861002R0821	207342			0,245	1
125	S801S-D125-R	2CCS861002R0841	207359			0,245	1	
2	6	S802S-D6-R*	2CCS862002R0061	408350			0,49	1
	8	S802S-D8-R*	2CCS862002R0081	411572			0,49	1
	10	S802S-D10-R	2CCS862002R0101	210175			0,49	1
	13	S802S-D13-R	2CCS862002R0131	210182			0,49	1
	16	S802S-D16-R	2CCS862002R0161	210199			0,49	1
	20	S802S-D20-R	2CCS862002R0201	210205			0,49	1
	25	S802S-D25-R	2CCS862002R0251	210212			0,49	1
	32	S802S-D32-R	2CCS862002R0321	210229			0,49	1
	40	S802S-D40-R	2CCS862002R0401	207366			0,49	1
	50	S802S-D50-R	2CCS862002R0501	207373			0,49	1
	63	S802S-D63-R	2CCS862002R0631	207380			0,49	1
	80	S802S-D80-R	2CCS862002R0801	207397			0,49	1
	100	S802S-D100-R	2CCS862002R0821	207403			0,49	1
125	S802S-D125-R	2CCS862002R0841	207410			0,49	1	

* Standard: EN/IEC 60947-2

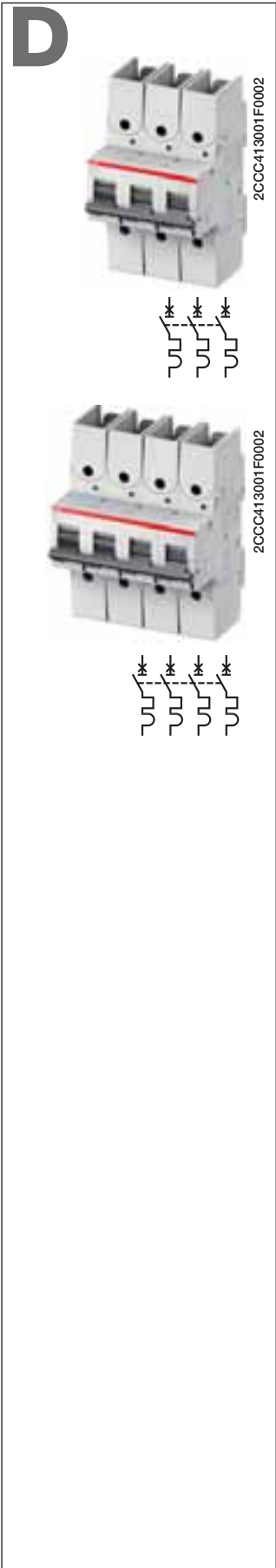

3	6	S803S-D6-R*	2CCS863002R0061	408367	0,735	1
	8	S803S-D8-R*	2CCS863002R0081	411589	0,735	1
	10	S803S-D10-R	2CCS863002R0101	210236	0,735	1
	13	S803S-D13-R	2CCS863002R0131	210243	0,735	1
	16	S803S-D16-R	2CCS863002R0161	210250	0,735	1
	20	S803S-D20-R	2CCS863002R0201	210267	0,735	1
	25	S803S-D25-R	2CCS863002R0251	210274	0,735	1
	32	S803S-D32-R	2CCS863002R0321	210281	0,735	1
	40	S803S-D40-R	2CCS863002R0401	207427	0,735	1
	50	S803S-D50-R	2CCS863002R0501	207434	0,735	1
	63	S803S-D63-R	2CCS863002R0631	207441	0,735	1
	80	S803S-D80-R	2CCS863002R0801	207458	0,735	1
	100	S803S-D100-R	2CCS863002R0821	207465	0,735	1
125	S803S-D125-R	2CCS863002R0841	207472	0,735	1	
4	6	S804S-D6-R*	2CCS864002R0061	408374	0,98	1
	8	S804S-D8-R*	2CCS864002R0081	411596	0,98	1
	10	S804S-D10-R	2CCS864002R0101	210298	0,98	1
	13	S804S-D13-R	2CCS864002R0131	210304	0,98	1
	16	S804S-D16-R	2CCS864002R0161	210311	0,98	1
	20	S804S-D20-R	2CCS864002R0201	210328	0,98	1
	25	S804S-D25-R	2CCS864002R0251	210335	0,98	1
	32	S804S-D32-R	2CCS864002R0321	210342	0,98	1
	40	S804S-D40-R	2CCS864002R0401	207489	0,98	1
	50	S804S-D50-R	2CCS864002R0501	207496	0,98	1
	63	S804S-D63-R	2CCS864002R0631	207502	0,98	1
	80	S804S-D80-R	2CCS864002R0801	207519	0,98	1
	100	S804S-D100-R	2CCS864002R0821	207526	0,98	1
125	S804S-D125-R	2CCS864002R0841	207533	0,98	1	

* Standard: EN/IEC 60947-2

K



S800S-K characteristic

Function: protection and control of the circuits like motors, transformer and auxiliary circuits, against overloads and short-circuits when a high breaking capacity is required; very useful when selectivity is needed vs an MCCB or back-up vs other MCBs wired downstream.

Advantages: no nuisance tripping in the case of functional peak currents up to 10xI_n, depending on the series; through its highly sensitive thermostatic bimetal trip, the K-type characteristic offers protection to damageable elements in the overcurrent range; it also provides the best protection to cables and lines.

Applications: commercial and industrial.

Standard: IEC/EN 60947-2

I_{cu}=50 kA

Number of poles	Rated current	Order details	Bbn	Price 1 piece	Price group	Weight 1 piece	Pack unit
In A	Type code	Order code	EAN			kg	pc.
1	6	S801S-K6	2CCS861001R0067	408220		0.245	1
	8	S801S-K8	2CCS861001R0407	411442		0.245	1
	10	S801S-K10	2CCS861001R0427	201449		0.245	1
	13	S801S-K13	2CCS861001R0447	201456		0.245	1
	16	S801S-K16	2CCS861001R0467	201463		0.245	1
	20	S801S-K20	2CCS861001R0487	201470		0.245	1
	25	S801S-K25	2CCS861001R0517	201487		0.245	1
	32	S801S-K32	2CCS861001R0537	201494		0.245	1
	40	S801S-K40	2CCS861001R0557	201500		0.245	1
	50	S801S-K50	2CCS861001R0577	201517		0.245	1
	63	S801S-K63	2CCS861001R0597	201524		0.245	1
	80	S801S-K80	2CCS861001R0627	201531		0.245	1
	100	S801S-K100	2CCS861001R0637	201548		0.245	1
125	S801S-K125	2CCS861001R0647	201555		0.245	1	
2	6	S802S-K6	2CCS862001R0067	408237		0.49	1
	8	S802S-K8	2CCS862001R0407	411459		0.49	1
	10	S802S-K10	2CCS862001R0427	201562		0.49	1
	13	S802S-K13	2CCS862001R0447	201579		0.49	1
	16	S802S-K16	2CCS862001R0467	201586		0.49	1
	20	S802S-K20	2CCS862001R0487	201593		0.49	1
	25	S802S-K25	2CCS862001R0517	201609		0.49	1
	32	S802S-K32	2CCS862001R0537	201616		0.49	1
	40	S802S-K40	2CCS862001R0557	201623		0.49	1
	50	S802S-K50	2CCS862001R0577	201630		0.49	1
	63	S802S-K63	2CCS862001R0597	201647		0.49	1
	80	S802S-K80	2CCS862001R0627	201654		0.49	1
	100	S802S-K100	2CCS862001R0637	201661		0.49	1
125	S802S-K125	2CCS862001R0647	201678		0.49	1	

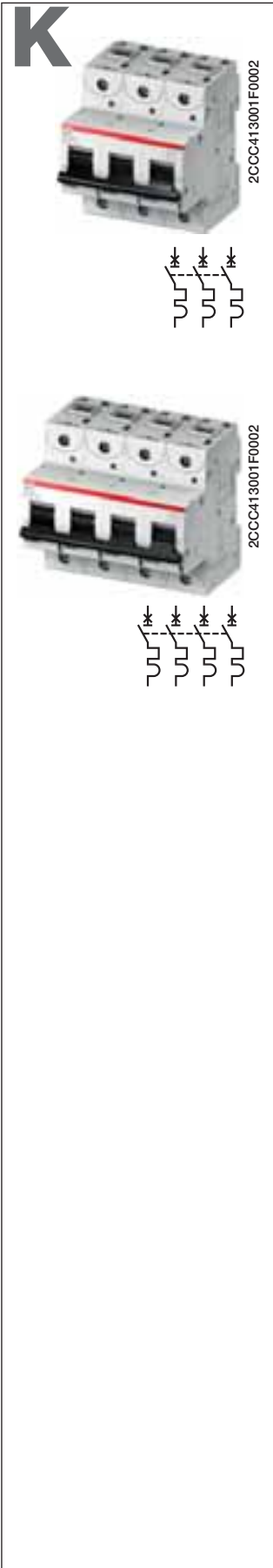

3	6	S803S-K6	2CCS863001R0067	408244	0.735	1
	8	S803S-K8	2CCS863001R0407	411466	0.735	1
	10	S803S-K10	2CCS863001R0427	201685	0.735	1
	13	S803S-K13	2CCS863001R0447	201692	0.735	1
	16	S803S-K16	2CCS863001R0467	201708	0.735	1
	20	S803S-K20	2CCS863001R0487	201715	0.735	1
	25	S803S-K25	2CCS863001R0517	201722	0.735	1
	32	S803S-K32	2CCS863001R0537	201739	0.735	1
	40	S803S-K40	2CCS863001R0557	201746	0.735	1
	50	S803S-K50	2CCS863001R0577	201753	0.735	1
	63	S803S-K63	2CCS863001R0597	201760	0.735	1
	80	S803S-K80	2CCS863001R0627	201777	0.735	1
	100	S803S-K100	2CCS863001R0637	201784	0.735	1
125	S803S-K125	2CCS863001R0647	201791	0.735	1	
4	6	S804S-K6	2CCS864001R0067	408251	0.98	1
	8	S804S-K8	2CCS864001R0407	411473	0.98	1
	10	S804S-K10	2CCS864001R0427	201807	0.98	1
	13	S804S-K13	2CCS864001R0447	201814	0.98	1
	16	S804S-K16	2CCS864001R0467	201821	0.98	1
	20	S804S-K20	2CCS864001R0487	201838	0.98	1
	25	S804S-K25	2CCS864001R0517	201845	0.98	1
	32	S804S-K32	2CCS864001R0537	201852	0.98	1
	40	S804S-K40	2CCS864001R0557	201869	0.98	1
	50	S804S-K50	2CCS864001R0577	201876	0.98	1
	63	S804S-K63	2CCS864001R0597	201883	0.98	1
	80	S804S-K80	2CCS864001R0627	201890	0.98	1
	100	S804S-K100	2CCS864001R0637	201906	0.98	1
125	S804S-K125	2CCS864001R0647	201913	0.98	1	

K

2



S800S-K characteristic

Function: protection and control of the circuits like motors, transformer and auxiliary circuits, against overloads and short-circuits when a high breaking capacity is required; very useful when selectivity is needed vs an MCCB or back-up vs other MCBs wired downstream.

Advantages: no nuisance tripping in the case of functional peak currents up to 10xIn, depending on the series; through its highly sensitive thermostatic bimetal trip, the K-type characteristic offers protection to damageable elements in the overcurrent range; it also provides the best protection to cables and lines.

Applications: commercial and industrial.

Standard: IEC/EN 60947-2

Icu=50 kA

Number of poles	Rated current	Order details	Bbn 7612271	Price 1 piece	Price group	Weight 1 piece	Pack unit
In A	Type code	Order code	EAN			kg	pc.
1	6	S801S-K6-R	2CCS861002R0067	408381		0,245	1
	8	S801S-K8-R	2CCS861002R0407	411602		0,245	1
	10	S801S-K10-R	2CCS861002R0427	209391		0,245	1
	13	S801S-K13-R	2CCS861002R0447	209407		0,245	1
	16	S801S-K16-R	2CCS861002R0467	209414		0,245	1
	20	S801S-K20-R	2CCS861002R0487	209421		0,245	1
	25	S801S-K25-R	2CCS861002R0517	209438		0,245	1
	32	S801S-K32-R	2CCS861002R0537	209445		0,245	1
	40	S801S-K40-R	2CCS861002R0557	207540		0,245	1
	50	S801S-K50-R	2CCS861002R0577	207557		0,245	1
	63	S801S-K63-R	2CCS861002R0597	207564		0,245	1
	80	S801S-K80-R	2CCS861002R0627	207571		0,245	1
	100	S801S-K100-R	2CCS861002R0637	207588		0,245	1
125	S801S-K125-R	2CCS861002R0647	207595		0,245	1	
2	6	S802S-K6-R	2CCS862002R0067	408398		0,49	1
	8	S802S-K8-R	2CCS862002R0407	411619		0,49	1
	10	S802S-K10-R	2CCS862002R0427	209452		0,49	1
	13	S802S-K13-R	2CCS862002R0447	209469		0,49	1
	16	S802S-K16-R	2CCS862002R0467	209476		0,49	1
	20	S802S-K20-R	2CCS862002R0487	209483		0,49	1
	25	S802S-K25-R	2CCS862002R0517	209490		0,49	1
	32	S802S-K32-R	2CCS862002R0537	209506		0,49	1
	40	S802S-K40-R	2CCS862002R0557	207601		0,49	1
	50	S802S-K50-R	2CCS862002R0577	207618		0,49	1
	63	S802S-K63-R	2CCS862002R0597	207625		0,49	1
	80	S802S-K80-R	2CCS862002R0627	207632		0,49	1
	100	S802S-K100-R	2CCS862002R0637	207649		0,49	1
125	S802S-K125-R	2CCS862002R0647	207656		0,49	1	

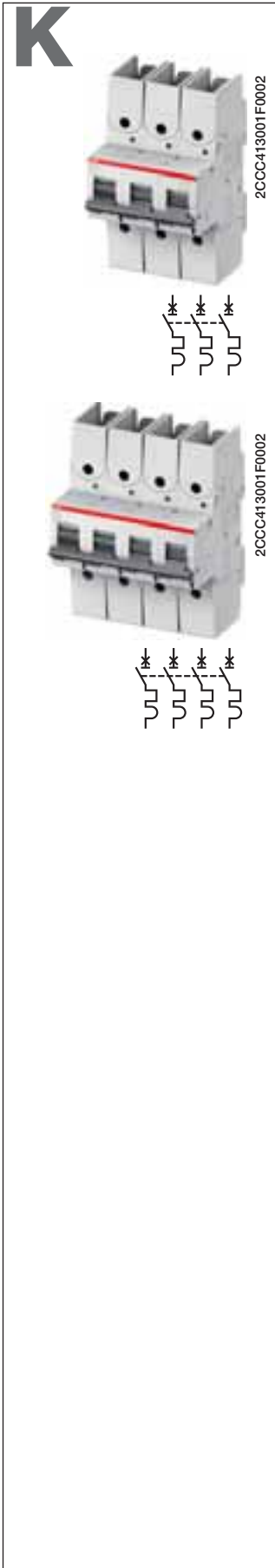

3	6	S803S-K6-R	2CCS863002R0067	408404	0,735	1
	8	S803S-K8-R	2CCS863002R0407	411626	0,735	1
	10	S803S-K10-R	2CCS863002R0427	209513	0,735	1
	13	S803S-K13-R	2CCS863002R0447	209520	0,735	1
	16	S803S-K16-R	2CCS863002R0467	209537	0,735	1
	20	S803S-K20-R	2CCS863002R0487	209544	0,735	1
	25	S803S-K25-R	2CCS863002R0517	209551	0,735	1
	32	S803S-K32-R	2CCS863002R0537	209568	0,735	1
	40	S803S-K40-R	2CCS863002R0557	207663	0,735	1
	50	S803S-K50-R	2CCS863002R0577	207670	0,735	1
	63	S803S-K63-R	2CCS863002R0597	207687	0,735	1
	80	S803S-K80-R	2CCS863002R0627	207694	0,735	1
	100	S803S-K100-R	2CCS863002R0637	207700	0,735	1
125	S803S-K125-R	2CCS863002R0647	207717	0,735	1	
4	6	S804S-K6-R	2CCS864002R0067	408411	0,98	1
	8	S804S-K8-R	2CCS864002R0407	411633	0,98	1
	10	S804S-K10-R	2CCS864002R0427	209575	0,98	1
	13	S804S-K13-R	2CCS864002R0447	209582	0,98	1
	16	S804S-K16-R	2CCS864002R0467	209599	0,98	1
	20	S804S-K20-R	2CCS864002R0487	209605	0,98	1
	25	S804S-K25-R	2CCS864002R0517	209612	0,98	1
	32	S804S-K32-R	2CCS864002R0537	209629	0,98	1
	40	S804S-K40-R	2CCS864002R0557	207724	0,98	1
	50	S804S-K50-R	2CCS864002R0577	207731	0,98	1
	63	S804S-K63-R	2CCS864002R0597	207748	0,98	1
	80	S804S-K80-R	2CCS864002R0627	207755	0,98	1
	100	S804S-K100-R	2CCS864002R0637	207762	0,98	1
125	S804S-K125-R	2CCS864002R0647	207779	0,98	1	

2

KM



2CCS413001F0002



S800S-KM characteristic with cage terminal

Function: protection and control of the circuits against overloads and short-circuits when a high breaking capacity is required; only magnetic version dedicated to protect motors; very useful when selectivity is needed vs an MCCB or back-up vs other MCBs wired downstream; version dedicated to application in direct current circuits.

Applications: commercial and industrial.

Standard: IEC/EN 60947-2

Icu=50 kA

Number of poles	Rated current	Order details	Bbn	Price 1 piece	Price group	Weight 1 piece	Pack unit
In A	Type code	Order code	EAN			kg	pc.
3	20	S803S-KM20	2CCS863001R0486	202194		0.735	1
	25	S803S-KM25	2CCS863001R0516	202200		0.735	1
	32	S803S-KM32	2CCS863001R0536	202217		0.735	1
	40	S803S-KM40	2CCS863001R0556	202224		0.735	1
	50	S803S-KM50	2CCS863001R0576	202231		0.735	1
	63	S803S-KM63	2CCS863001R0596	202248		0.735	1
	80	S803S-KM80	2CCS863001R0626	202255		0.735	1

KM



2CCS413001F0002



S800S-KM-R characteristic with ring terminal connection

Function: protection and control of the circuits against overloads and short-circuits when a high breaking capacity is required; only magnetic version dedicated to protect motors; very useful when selectivity is needed vs an MCCB or back-up vs other MCBs wired downstream; version dedicated to application in direct current circuits.

Applications: commercial and industrial.

Standard: IEC/EN 60947-2

Icu=50 kA

Number of poles	Rated current	Order details	Bbn	Price 1 piece	Price group	Weight 1 piece	Pack unit
In A	Type code	Order code	EAN			kg	pc.
3	20	S803S-KM20-R	2CCS863002R0486	210830		0,735	1
	25	S803S-KM25-R	2CCS863002R0516	210847		0,735	1
	32	S803S-KM32-R	2CCS863002R0536	210854		0,735	1
	40	S803S-KM40-R	2CCS863002R0556	207786		0,735	1
	50	S803S-KM50-R	2CCS863002R0576	207793		0,735	1
	63	S803S-KM63-R	2CCS863002R0596	207809		0,735	1
	80	S803S-KM80-R	2CCS863002R0626	207816		0,735	1

B



2CCC413001F0002



2CCC413001F0002



2CCC413001F0002



2CCC413001F0002



S800S-UCB characteristic

Function: protection and control of the circuits against overloads and short-circuits when a high breaking capacity is required; protection for people and big length cables in TN and IT systems; very useful when selectivity is needed vs an MCCB or back-up vs other MCBs wired downstream; version dedicated to application in direct current circuits.

Applications: commercial and industrial.

Standard: IEC/EN 60947-2

Icu=50 kA

Number of poles	Rated current	Order details	Bbn	Price 1 piece	Price group	Weight 1 piece	Pack unit
In A	Type code	Order code	EAN			kg	pc.
1	10	S801S-UCB10	2CCS861001R1105	202842		0.245	1
	13	S801S-UCB13	2CCS861001R1135	202859		0.245	1
	16	S801S-UCB16	2CCS861001R1165	202866		0.245	1
	20	S801S-UCB20	2CCS861001R1205	202873		0.245	1
	25	S801S-UCB25	2CCS861001R1255	202880		0.245	1
	32	S801S-UCB32	2CCS861001R1325	202897		0.245	1
	40	S801S-UCB40	2CCS861001R1405	202903		0.245	1
	50	S801S-UCB50	2CCS861001R1505	202910		0.245	1
	63	S801S-UCB63	2CCS861001R1635	202927		0.245	1
	80	S801S-UCB80	2CCS861001R1805	202934		0.245	1
	100	S801S-UCB100	2CCS861001R1825	202941		0.245	1
	125	S801S-UCB125	2CCS861001R1845	202958		0.245	1
2	10	S802S-UCB10	2CCS862001R1105	202965		0.49	1
	13	S802S-UCB13	2CCS862001R1135	202972		0.49	1
	16	S802S-UCB16	2CCS862001R1165	202989		0.49	1
	20	S802S-UCB20	2CCS862001R1205	202996		0.49	1
	25	S802S-UCB25	2CCS862001R1255	203009		0.49	1
	32	S802S-UCB32	2CCS862001R1325	203016		0.49	1
	40	S802S-UCB40	2CCS862001R1405	203023		0.49	1
	50	S802S-UCB50	2CCS862001R1505	203030		0.49	1
	63	S802S-UCB63	2CCS862001R1635	203047		0.49	1
	80	S802S-UCB80	2CCS862001R1805	203054		0.49	1
	100	S802S-UCB100	2CCS862001R1825	203061		0.49	1
	125	S802S-UCB125	2CCS862001R1845	203078		0.49	1
3	10	S803S-UCB10	2CCS863001R1105	203085		0.735	1
	13	S803S-UCB13	2CCS863001R1135	203092		0.735	1
	16	S803S-UCB16	2CCS863001R1165	203108		0.735	1
	20	S803S-UCB20	2CCS863001R1205	203115		0.735	1
	25	S803S-UCB25	2CCS863001R1255	203122		0.735	1
	32	S803S-UCB32	2CCS863001R1325	203139		0.735	1
	40	S803S-UCB40	2CCS863001R1405	203146		0.735	1
	50	S803S-UCB50	2CCS863001R1505	203153		0.735	1
	63	S803S-UCB63	2CCS863001R1635	203160		0.735	1
	80	S803S-UCB80	2CCS863001R1805	203177		0.735	1
	100	S803S-UCB100	2CCS863001R1825	203184		0.735	1
	125	S803S-UCB125	2CCS863001R1845	203191		0.735	1
4	10	S804S-UCB10	2CCS864001R1105	203207		0.98	1
	13	S804S-UCB13	2CCS864001R1135	203214		0.98	1
	16	S804S-UCB16	2CCS864001R1165	203221		0.98	1
	20	S804S-UCB20	2CCS864001R1205	203238		0.98	1
	25	S804S-UCB25	2CCS864001R1255	203245		0.98	1
	32	S804S-UCB32	2CCS864001R1325	203252		0.98	1
	40	S804S-UCB40	2CCS864001R1405	203269		0.98	1
	50	S804S-UCB50	2CCS864001R1505	203276		0.98	1
	63	S804S-UCB63	2CCS864001R1635	203283		0.98	1
	80	S804S-UCB80	2CCS864001R1805	203290		0.98	1
	100	S804S-UCB100	2CCS864001R1825	203306		0.98	1
	125	S804S-UCB125	2CCS864001R1845	203313		0.98	1

2

B

2



2CCS413001F0002



2CCS413001F0002



2CCS413001F0002



2CCS413001F0002



S800S-UCB characteristic

Function: protection and control of the circuits against overloads and short-circuits when a high breaking capacity is required; protection for people and big length cables in TN and IT systems; very useful when selectivity is needed vs an MCCB or back-up vs other MCBs wired downstream; version dedicated to application in direct current circuits.

Applications: commercial and industrial.

Standard: IEC/EN 60947-2

I_{cu}=50 kA

Number of poles	Rated current	Order details	Bbn	Price 1 piece	Price group	Weight 1 piece	Pack unit
In A	Type code	Order code	EAN			kg	pc.
1	10	S801S-UCB10-R	2CCS861002R1105	210359		0,245	1
	13	S801S-UCB13-R	2CCS861002R1135	210366		0,245	1
	16	S801S-UCB16-R	2CCS861002R1165	210373		0,245	1
	20	S801S-UCB20-R	2CCS861002R1205	210380		0,245	1
	25	S801S-UCB25-R	2CCS861002R1255	210397		0,245	1
	32	S801S-UCB32-R	2CCS861002R1325	210403		0,245	1
	40	S801S-UCB40-R	2CCS861002R1405	208424		0,245	1
	50	S801S-UCB50-R	2CCS861002R1505	208431		0,245	1
	63	S801S-UCB63-R	2CCS861002R1635	208448		0,245	1
	80	S801S-UCB80-R	2CCS861002R1805	208455		0,245	1
	100	S801S-UCB100-R	2CCS861002R1825	208462		0,245	1
	125	S801S-UCB125-R	2CCS861002R1845	208479		0,245	1
2	10	S802S-UCB10-R	2CCS862002R1105	210410		0,49	1
	13	S802S-UCB13-R	2CCS862002R1135	210427		0,49	1
	16	S802S-UCB16-R	2CCS862002R1165	210434		0,49	1
	20	S802S-UCB20-R	2CCS862002R1205	210441		0,49	1
	25	S802S-UCB25-R	2CCS862002R1255	210458		0,49	1
	32	S802S-UCB32-R	2CCS862002R1325	210465		0,49	1
	40	S802S-UCB40-R	2CCS862002R1405	208486		0,49	1
	50	S802S-UCB50-R	2CCS862002R1505	208493		0,49	1
	63	S802S-UCB63-R	2CCS862002R1635	208509		0,49	1
	80	S802S-UCB80-R	2CCS862002R1805	208516		0,49	1
	100	S802S-UCB100-R	2CCS862002R1825	208523		0,49	1
	125	S802S-UCB125-R	2CCS862002R1845	208530		0,49	1
3	10	S803S-UCB10-R	2CCS863002R1105	210472		0,735	1
	13	S803S-UCB13-R	2CCS863002R1135	210489		0,735	1
	16	S803S-UCB16-R	2CCS863002R1165	210496		0,735	1
	20	S803S-UCB20-R	2CCS863002R1205	210502		0,735	1
	25	S803S-UCB25-R	2CCS863002R1255	210519		0,735	1
	32	S803S-UCB32-R	2CCS863002R1325	210526		0,735	1
	40	S803S-UCB40-R	2CCS863002R1405	208547		0,735	1
	50	S803S-UCB50-R	2CCS863002R1505	208554		0,735	1
	63	S803S-UCB63-R	2CCS863002R1635	208561		0,735	1
	80	S803S-UCB80-R	2CCS863002R1805	208578		0,735	1
	100	S803S-UCB100-R	2CCS863002R1825	208585		0,735	1
	125	S803S-UCB125-R	2CCS863002R1845	208592		0,735	1
4	10	S804S-UCB10-R	2CCS864002R1105	210533		0,98	1
	13	S804S-UCB13-R	2CCS864002R1135	210540		0,98	1
	16	S804S-UCB16-R	2CCS864002R1165	210557		0,98	1
	20	S804S-UCB20-R	2CCS864002R1205	210564		0,98	1
	25	S804S-UCB25-R	2CCS864002R1255	210571		0,98	1
	32	S804S-UCB32-R	2CCS864002R1325	210588		0,98	1
	40	S804S-UCB40-R	2CCS864002R1405	208608		0,98	1
	50	S804S-UCB50-R	2CCS864002R1505	208615		0,98	1
	63	S804S-UCB63-R	2CCS864002R1635	208622		0,98	1
	80	S804S-UCB80-R	2CCS864002R1805	208639		0,98	1
	100	S804S-UCB100-R	2CCS864002R1825	208646		0,98	1
	125	S804S-UCB125-R	2CCS864002R1845	208653		0,98	1

K



2CCC413001F0002



2CCC413001F0002



2CCC413001F0002

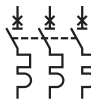

2CCC413001F0002



S800S-UCK characteristic

Function: protection and control of the circuits like motors, transformer and auxiliary circuits, against overloads and short-circuits when a high breaking capacity is required; very useful when selectivity is needed vs an MCCB or back-up vs other MCBs wired downstream; version dedicated to application in direct current circuits.

Advantages: no nuisance tripping in the case of functional peak currents up to 10xIn, depending on the series; through its highly sensitive thermostatic bimetal trip, the K-type characteristic offers protection to damageable elements in the overcurrent range; it also provides the best protection to cables and lines.

Applications: commercial and industrial.

Standard: IEC/EN 60947-2

Icu=50 kA

Number of poles	Rated current In A	Order details	Bbn 7612271	Price 1 piece	Price group	Weight 1 piece kg	Pack unit pc.
1	10	S801S-UCK10	2CCS861001R1427	203320		0.245	1
	13	S801S-UCK13	2CCS861001R1447	203337		0.245	1
	16	S801S-UCK16	2CCS861001R1467	203344		0.245	1
	20	S801S-UCK20	2CCS861001R1487	203351		0.245	1
	25	S801S-UCK25	2CCS861001R1517	203368		0.245	1
	32	S801S-UCK32	2CCS861001R1537	203375		0.245	1
	40	S801S-UCK40	2CCS861001R1557	203382		0.245	1
	50	S801S-UCK50	2CCS861001R1577	203399		0.245	1
	63	S801S-UCK63	2CCS861001R1597	203405		0.245	1
	80	S801S-UCK80	2CCS861001R1627	203412		0.245	1
	100	S801S-UCK100	2CCS861001R1637	203429		0.245	1
	125	S801S-UCK125	2CCS861001R1647	203436		0.245	1
2	10	S802S-UCK10	2CCS862001R1427	203443		0.49	1
	13	S802S-UCK13	2CCS862001R1447	203450		0.49	1
	16	S802S-UCK16	2CCS862001R1467	203467		0.49	1
	20	S802S-UCK20	2CCS862001R1487	203474		0.49	1
	25	S802S-UCK25	2CCS862001R1517	203481		0.49	1
	32	S802S-UCK32	2CCS862001R1537	203498		0.49	1
	40	S802S-UCK40	2CCS862001R1557	203504		0.49	1
	50	S802S-UCK50	2CCS862001R1577	203511		0.49	1
	63	S802S-UCK63	2CCS862001R1597	203528		0.49	1
	80	S802S-UCK80	2CCS862001R1627	203535		0.49	1
	100	S802S-UCK100	2CCS862001R1637	203542		0.49	1
	125	S802S-UCK125	2CCS862001R1647	203559		0.49	1
3	10	S803S-UCK10	2CCS863001R1427	203566		0.735	1
	13	S803S-UCK13	2CCS863001R1447	203573		0.735	1
	16	S803S-UCK16	2CCS863001R1467	203580		0.735	1
	20	S803S-UCK20	2CCS863001R1487	203597		0.735	1
	25	S803S-UCK25	2CCS863001R1517	203603		0.735	1
	32	S803S-UCK32	2CCS863001R1537	203610		0.735	1
	40	S803S-UCK40	2CCS863001R1557	203627		0.735	1
	50	S803S-UCK50	2CCS863001R1577	203634		0.735	1
	63	S803S-UCK63	2CCS863001R1597	203641		0.735	1
	80	S803S-UCK80	2CCS863001R1627	203658		0.735	1
	100	S803S-UCK100	2CCS863001R1637	203665		0.735	1
	125	S803S-UCK125	2CCS863001R1647	203672		0.735	1
4	10	S804S-UCK10	2CCS864001R1427	203689		0.98	1
	13	S804S-UCK13	2CCS864001R1447	203696		0.98	1
	16	S804S-UCK16	2CCS864001R1467	203702		0.98	1
	20	S804S-UCK20	2CCS864001R1487	203719		0.98	1
	25	S804S-UCK25	2CCS864001R1517	203726		0.98	1
	32	S804S-UCK32	2CCS864001R1537	203733		0.98	1
	40	S804S-UCK40	2CCS864001R1557	203740		0.98	1
	50	S804S-UCK50	2CCS864001R1577	203757		0.98	1
	63	S804S-UCK63	2CCS864001R1597	203764		0.98	1
	80	S804S-UCK80	2CCS864001R1627	203771		0.98	1
	100	S804S-UCK100	2CCS864001R1637	203788		0.98	1
	125	S804S-UCK125	2CCS864001R1647	203795		0.98	1

2

K

2



2CCS413001F0002



2CCS413001F0002



2CCS413001F0002

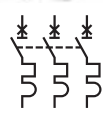

2CCS413001F0002

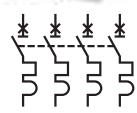

S800S-UCK characteristic

Function: protection and control of the circuits like motors, transformer and auxiliary circuits, against overloads and short-circuits when a high breaking capacity is required; very useful when selectivity is needed vs an MCCB or back-up vs other MCBs wired downstream; version dedicated to application in direct current circuits.

Advantages: no nuisance tripping in the case of functional peak currents up to 10xIn, depending on the series; through its highly sensitive thermostatic bimetal trip, the K-type characteristic offers protection to damageable elements in the overcurrent range; it also provides the best protection to cables and lines.

Applications: commercial and industrial.

Standard: IEC/EN 60947-2

Icu=50 kA

Number of poles	Rated current	Order details	Bbn	Price 1 piece	Price group	Weight 1 piece	Pack unit
In A	Type code	Order code	EAN			kg	pc.
1	10	S801S-UCK10-R	2CCS861002R1427	210595		0,245	1
	13	S801S-UCK13-R	2CCS861002R1447	210601		0,245	1
	16	S801S-UCK16-R	2CCS861002R1467	210618		0,245	1
	20	S801S-UCK20-R	2CCS861002R1487	210625		0,245	1
	25	S801S-UCK25-R	2CCS861002R1517	210632		0,245	1
	32	S801S-UCK32-R	2CCS861002R1537	210649		0,245	1
	40	S801S-UCK40-R	2CCS861002R1557	208660		0,245	1
	50	S801S-UCK50-R	2CCS861002R1577	208677		0,245	1
	63	S801S-UCK63-R	2CCS861002R1597	208684		0,245	1
	80	S801S-UCK80-R	2CCS861002R1627	208691		0,245	1
	100	S801S-UCK100-R	2CCS861002R1637	208707		0,245	1
	125	S801S-UCK125-R	2CCS861002R1647	208714		0,245	1
2	10	S802S-UCK10-R	2CCS862002R1427	210656		0,490	1
	13	S802S-UCK13-R	2CCS862002R1447	210663		0,490	1
	16	S802S-UCK16-R	2CCS862002R1467	210670		0,490	1
	20	S802S-UCK20-R	2CCS862002R1487	210687		0,490	1
	25	S802S-UCK25-R	2CCS862002R1517	210694		0,490	1
	32	S802S-UCK32-R	2CCS862002R1537	210700		0,490	1
	40	S802S-UCK40-R	2CCS862002R1557	208721		0,490	1
	50	S802S-UCK50-R	2CCS862002R1577	208738		0,490	1
	63	S802S-UCK63-R	2CCS862002R1597	208745		0,490	1
	80	S802S-UCK80-R	2CCS862002R1627	208752		0,490	1
	100	S802S-UCK100-R	2CCS862002R1637	208769		0,490	1
	125	S802S-UCK125-R	2CCS862002R1647	208776		0,490	1
3	10	S803S-UCK10-R	2CCS863002R1427	210717		0,735	1
	13	S803S-UCK13-R	2CCS863002R1447	210724		0,735	1
	16	S803S-UCK16-R	2CCS863002R1467	210731		0,735	1
	20	S803S-UCK20-R	2CCS863002R1487	210748		0,735	1
	25	S803S-UCK25-R	2CCS863002R1517	210755		0,735	1
	32	S803S-UCK32-R	2CCS863002R1537	210762		0,735	1
	40	S803S-UCK40-R	2CCS863002R1557	208783		0,735	1
	50	S803S-UCK50-R	2CCS863002R1577	208790		0,735	1
	63	S803S-UCK63-R	2CCS863002R1597	208806		0,735	1
	80	S803S-UCK80-R	2CCS863002R1627	208813		0,735	1
	100	S803S-UCK100-R	2CCS863002R1637	208820		0,735	1
	125	S803S-UCK125-R	2CCS863002R1647	208837		0,735	1
4	10	S804S-UCK10-R	2CCS864002R1427	210779		0,98	1
	13	S804S-UCK13-R	2CCS864002R1447	210786		0,98	1
	16	S804S-UCK16-R	2CCS864002R1467	210793		0,98	1
	20	S804S-UCK20-R	2CCS864002R1487	210809		0,98	1
	25	S804S-UCK25-R	2CCS864002R1517	210816		0,98	1
	32	S804S-UCK32-R	2CCS864002R1537	210823		0,98	1
	40	S804S-UCK40-R	2CCS864002R1557	208844		0,98	1
	50	S804S-UCK50-R	2CCS864002R1577	208851		0,98	1
	63	S804S-UCK63-R	2CCS864002R1597	208868		0,98	1
	80	S804S-UCK80-R	2CCS864002R1627	208875		0,98	1
	100	S804S-UCK100-R	2CCS864002R1637	208882		0,98	1
	125	S804S-UCK125-R	2CCS864002R1647	208899		0,98	1

B



2CCC413001F0002



2CCC413001F0002



2CCC413001F0002



2CCC413001F0002



S800N-B characteristic

Function: protection and control of the circuits against overloads and short-circuits when a high breaking capacity is required; protection for people and big length cables in TN and IT systems; very useful when selectivity is needed vs an MCCB or back-up vs other MCBs wired downstream.

Applications: commercial and industrial.

Standard: IEC/EN 60898, IEC/EN 60947-2

Icn=20 kA (10 ... 80 A)

Icu=36 kA

Number of poles	Rated current In A	Order details Type code	Order code	Bbn	Price	Price	Weight	Pack
				7612271	1 piece	group	1 piece	unit
				EAN			kg	pc.
1	10	S801N-B10	2CCS891001R0105	203801			0.24	1
	13	S801N-B13	2CCS891001R0135	203818			0.24	1
	16	S801N-B16	2CCS891001R0165	203825			0.24	1
	20	S801N-B20	2CCS891001R0205	203832			0.24	1
	25	S801N-B25	2CCS891001R0255	203849			0.24	1
	32	S801N-B32	2CCS891001R0325	203856			0.24	1
	40	S801N-B40	2CCS891001R0405	203863			0.24	1
	50	S801N-B50	2CCS891001R0505	203870			0.24	1
	63	S801N-B63	2CCS891001R0635	203887			0.24	1
	80	S801N-B80	2CCS891001R0805	203894			0.24	1
	100	S801N-B100	2CCS891001R0825	203900			0.24	1
	125	S801N-B125	2CCS891001R0845	203917			0.24	1
2	10	S802N-B10	2CCS892001R0105	203924			0.48	1
	13	S802N-B13	2CCS892001R0135	203931			0.48	1
	16	S802N-B16	2CCS892001R0165	203948			0.48	1
	20	S802N-B20	2CCS892001R0205	203955			0.48	1
	25	S802N-B25	2CCS892001R0255	203962			0.48	1
	32	S802N-B32	2CCS892001R0325	203979			0.48	1
	40	S802N-B40	2CCS892001R0405	203986			0.48	1
	50	S802N-B50	2CCS892001R0505	203993			0.48	1
	63	S802N-B63	2CCS892001R0635	204006			0.48	1
	80	S802N-B80	2CCS892001R0805	204013			0.48	1
	100	S802N-B100	2CCS892001R0825	204020			0.48	1
	125	S802N-B125	2CCS892001R0845	204037			0.48	1
3	10	S803N-B10	2CCS893001R0105	204044			0.72	1
	13	S803N-B13	2CCS893001R0135	204051			0.72	1
	16	S803N-B16	2CCS893001R0165	204068			0.72	1
	20	S803N-B20	2CCS893001R0205	204075			0.72	1
	25	S803N-B25	2CCS893001R0255	204082			0.72	1
	32	S803N-B32	2CCS893001R0325	204099			0.72	1
	40	S803N-B40	2CCS893001R0405	204105			0.72	1
	50	S803N-B50	2CCS893001R0505	204112			0.72	1
	63	S803N-B63	2CCS893001R0635	204129			0.72	1
	80	S803N-B80	2CCS893001R0805	204136			0.72	1
	100	S803N-B100	2CCS893001R0825	204143			0.72	1
	125	S803N-B125	2CCS893001R0845	204150			0.72	1
4	10	S804N-B10	2CCS894001R0105	204167			0.96	1
	13	S804N-B13	2CCS894001R0135	204174			0.96	1
	16	S804N-B16	2CCS894001R0165	204181			0.96	1
	20	S804N-B20	2CCS894001R0205	204198			0.96	1
	25	S804N-B25	2CCS894001R0255	204204			0.96	1
	32	S804N-B32	2CCS894001R0325	204211			0.96	1
	40	S804N-B40	2CCS894001R0405	204228			0.96	1
	50	S804N-B50	2CCS894001R0505	204235			0.96	1
	63	S804N-B63	2CCS894001R0635	204242			0.96	1
	80	S804N-B80	2CCS894001R0805	204259			0.96	1
	100	S804N-B100	2CCS894001R0825	204266			0.96	1
	125	S804N-B125	2CCS894001R0845	204273			0.96	1

C



2CCC413001F0002



2CCC413001F0002



2CCC413001F0002



2CCC413001F0002



S800N-C characteristic

Function: protection and control of the circuits against overloads and short-circuits when a high breaking capacity is required; protection for resistive and inductive loads with low inrush current; very useful when selectivity is needed vs an MCCB or back-up vs other MCBs wired downstream.

Applications: commercial and industrial.

Standard: IEC/EN 60898, IEC/EN 60947-2

Icn=20 kA (10 ... 80 A)

Icu=36 kA

Number of poles	Rated current In A	Order details Type code	Order code	Bbn	Price	Price group	Weight	Pack
				7612271	1 piece		1 piece	unit
				EAN			kg	pc.
1	10	S801N-C10	2CCS891001R0104	204280			0.24	1
	13	S801N-C13	2CCS891001R0134	204297			0.24	1
	16	S801N-C16	2CCS891001R0164	204303			0.24	1
	20	S801N-C20	2CCS891001R0204	204310			0.24	1
	25	S801N-C25	2CCS891001R0254	204327			0.24	1
	32	S801N-C32	2CCS891001R0324	204334			0.24	1
	40	S801N-C40	2CCS891001R0404	204341			0.24	1
	50	S801N-C50	2CCS891001R0504	204358			0.24	1
	63	S801N-C63	2CCS891001R0634	204365			0.24	1
	80	S801N-C80	2CCS891001R0804	204372			0.24	1
	100	S801N-C100	2CCS891001R0824	204389			0.24	1
	125	S801N-C125	2CCS891001R0844	204396			0.24	1
2	10	S802N-C10	2CCS892001R0104	204402			0.48	1
	13	S802N-C13	2CCS892001R0134	204419			0.48	1
	16	S802N-C16	2CCS892001R0164	204426			0.48	1
	20	S802N-C20	2CCS892001R0204	204433			0.48	1
	25	S802N-C25	2CCS892001R0254	204440			0.48	1
	32	S802N-C32	2CCS892001R0324	204457			0.48	1
	40	S802N-C40	2CCS892001R0404	204464			0.48	1
	50	S802N-C50	2CCS892001R0504	204471			0.48	1
	63	S802N-C63	2CCS892001R0634	204488			0.48	1
	80	S802N-C80	2CCS892001R0804	204495			0.48	1
	100	S802N-C100	2CCS892001R0824	204501			0.48	1
	125	S802N-C125	2CCS892001R0844	204518			0.48	1
3	10	S803N-C10	2CCS893001R0104	204525			0.72	1
	13	S803N-C13	2CCS893001R0134	204532			0.72	1
	16	S803N-C16	2CCS893001R0164	204549			0.72	1
	20	S803N-C20	2CCS893001R0204	204556			0.72	1
	25	S803N-C25	2CCS893001R0254	204563			0.72	1
	32	S803N-C32	2CCS893001R0324	204570			0.72	1
	40	S803N-C40	2CCS893001R0404	204587			0.72	1
	50	S803N-C50	2CCS893001R0504	204594			0.72	1
	63	S803N-C63	2CCS893001R0634	204600			0.72	1
	80	S803N-C80	2CCS893001R0804	204617			0.72	1
	100	S803N-C100	2CCS893001R0824	204624			0.72	1
	125	S803N-C125	2CCS893001R0844	204631			0.72	1
4	10	S804N-C10	2CCS894001R0104	204648			0.96	1
	13	S804N-C13	2CCS894001R0134	204655			0.96	1
	16	S804N-C16	2CCS894001R0164	204662			0.96	1
	20	S804N-C20	2CCS894001R0204	204679			0.96	1
	25	S804N-C25	2CCS894001R0254	204686			0.96	1
	32	S804N-C32	2CCS894001R0324	204693			0.96	1
	40	S804N-C40	2CCS894001R0404	204709			0.96	1
	50	S804N-C50	2CCS894001R0504	204716			0.96	1
	63	S804N-C63	2CCS894001R0634	204723			0.96	1
	80	S804N-C80	2CCS894001R0804	204730			0.96	1
	100	S804N-C100	2CCS894001R0824	204747			0.96	1
	125	S804N-C125	2CCS894001R0844	204754			0.96	1

D

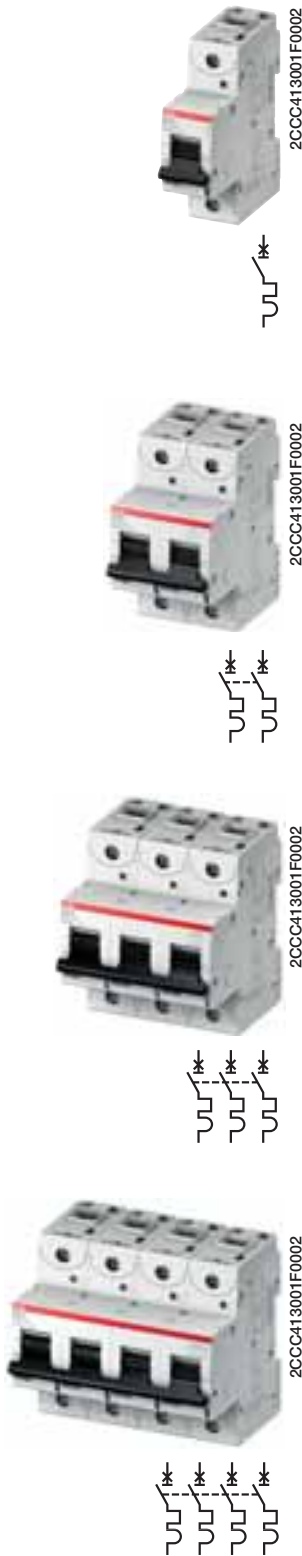

S800N-D characteristic

Function: protection and control of the circuits against overloads and short-circuits when a high breaking capacity is required; protection for circuits which supply loads with high inrush current at the circuit closing (motors, LV / LV transformers, breakdown lamps); very useful when selectivity is needed vs an MCCB or back-up vs other MCBs wired downstream.

Applications: commercial and industrial.

Standard: IEC/EN 60898, IEC/EN 60947-2

Icn=20 kA (10 ... 80 A)

Icu=36 kA

Number of poles	Rated current In A	Order details Type code	Order code	Bbn 7612271 EAN	Price 1 piece	Price group	Weight 1 piece kg	Pack unit pc.	
1	10	S801N-D10	2CCS891001R0101	204761			0.245	1	
	13	S801N-D13	2CCS891001R0131	204778			0.245	1	
	16	S801N-D16	2CCS891001R0161	204785			0.245	1	
	20	S801N-D20	2CCS891001R0201	204792			0.245	1	
	25	S801N-D25	2CCS891001R0251	204808			0.245	1	
	32	S801N-D32	2CCS891001R0321	204815			0.245	1	
	40	S801N-D40	2CCS891001R0401	204822			0.245	1	
	50	S801N-D50	2CCS891001R0501	204839			0.245	1	
	63	S801N-D63	2CCS891001R0631	204846			0.245	1	
	80	S801N-D80	2CCS891001R0801	204853			0.245	1	
	100	S801N-D100	2CCS891001R0821	204860			0.245	1	
	125	S801N-D125	2CCS891001R0841	204877			0.245	1	
	2	10	S802N-D10	2CCS892001R0101	204884			0.49	1
		13	S802N-D13	2CCS892001R0131	204891			0.49	1
		16	S802N-D16	2CCS892001R0161	204907			0.49	1
20		S802N-D20	2CCS892001R0201	204914			0.49	1	
25		S802N-D25	2CCS892001R0251	204921			0.49	1	
32		S802N-D32	2CCS892001R0321	204938			0.49	1	
40		S802N-D40	2CCS892001R0401	204945			0.49	1	
50		S802N-D50	2CCS892001R0501	204952			0.49	1	
63		S802N-D63	2CCS892001R0631	204969			0.49	1	
80		S802N-D80	2CCS892001R0801	204976			0.49	1	
100		S802N-D100	2CCS892001R0821	204983			0.49	1	
125		S802N-D125	2CCS892001R0841	204990			0.49	1	
3		10	S803N-D10	2CCS893001R0101	205003			0.735	1
		13	S803N-D13	2CCS893001R0131	205010			0.735	1
		16	S803N-D16	2CCS893001R0161	205027			0.735	1
	20	S803N-D20	2CCS893001R0201	205034			0.735	1	
	25	S803N-D25	2CCS893001R0251	205041			0.735	1	
	32	S803N-D32	2CCS893001R0321	205058			0.735	1	
	40	S803N-D40	2CCS893001R0401	205065			0.735	1	
	50	S803N-D50	2CCS893001R0501	205072			0.735	1	
	63	S803N-D63	2CCS893001R0631	205089			0.735	1	
	80	S803N-D80	2CCS893001R0801	205096			0.735	1	
	100	S803N-D100	2CCS893001R0821	205102			0.735	1	
	125	S803N-D125	2CCS893001R0841	205119			0.735	1	
	4	10	S804N-D10	2CCS894001R0101	205126			0.98	1
		13	S804N-D13	2CCS894001R0131	205133			0.98	1
		16	S804N-D16	2CCS894001R0161	205140			0.98	1
20		S804N-D20	2CCS894001R0201	205157			0.98	1	
25		S804N-D25	2CCS894001R0251	205164			0.98	1	
32		S804N-D32	2CCS894001R0321	205171			0.98	1	
40		S804N-D40	2CCS894001R0401	205188			0.98	1	
50		S804N-D50	2CCS894001R0501	205195			0.98	1	
63		S804N-D63	2CCS894001R0631	205201			0.98	1	
80		S804N-D80	2CCS894001R0801	205218			0.98	1	
100		S804N-D100	2CCS894001R0821	205225			0.98	1	
125		S804N-D125	2CCS894001R0841	205232			0.98	1	

B



2CCC413001F0002



2CCC413001F0002



2CCC413001F0002



2CCC413001F0002



S800C-B characteristic

Function: protection and control of the circuits against overloads and short-circuits when a high breaking capacity is required; protection for people and big length cables in TN and IT systems; very useful when selectivity is needed vs an MCCB or back-up vs other MCBs wired downstream.

Applications: commercial and industrial.

Standard: IEC/EN 60947-2, IEC/EN 60898

Icn=15 kA

Icu=25 kA

Number of poles	Rated current	Order details	Bbn	Price 1 piece	Price group	Weight 1 piece	Pack unit
In A	Type code	Order code	EAN			kg	pc.
1	10	S801C-B10	2CCS881001R0105	212087		0.245	1
	13	S801C-B13	2CCS881001R0135	212247		0.245	1
	16	S801C-B16	2CCS881001R0165	212407		0.245	1
	20	S801C-B20	2CCS881001R0205	212568		0.245	1
	25	S801C-B25	2CCS881001R0255	212728		0.245	1
	32	S801C-B32	2CCS881001R0325	212889		0.245	1
	40	S801C-B40	2CCS881001R0405	213046		0.245	1
	50	S801C-B50	2CCS881001R0505	213206		0.245	1
	63	S801C-B63	2CCS881001R0635	213367		0.245	1
	80	S801C-B80	2CCS881001R0805	213527		0.245	1
	100	S801C-B100	2CCS881001R0825	213688		0.245	1
	125	S801C-B125	2CCS881001R0845	213848		0.245	1
2	10	S802C-B10	2CCS882001R0105	212094		0.49	1
	13	S802C-B13	2CCS882001R0135	212254		0.49	1
	16	S802C-B16	2CCS882001R0165	212414		0.49	1
	20	S802C-B20	2CCS882001R0205	212575		0.49	1
	25	S802C-B25	2CCS882001R0255	212735		0.49	1
	32	S802C-B32	2CCS882001R0325	212896		0.49	1
	40	S802C-B40	2CCS882001R0405	213053		0.49	1
	50	S802C-B50	2CCS882001R0505	213213		0.49	1
	63	S802C-B63	2CCS882001R0635	213374		0.49	1
	80	S802C-B80	2CCS882001R0805	213534		0.49	1
	100	S802C-B100	2CCS882001R0825	213695		0.49	1
	125	S802C-B125	2CCS882001R0845	213855		0.49	1
3	10	S803C-B10	2CCS883001R0105	212100		0.735	1
	13	S803C-B13	2CCS883001R0135	212261		0.735	1
	16	S803C-B16	2CCS883001R0165	212421		0.735	1
	20	S803C-B20	2CCS883001R0205	212582		0.735	1
	25	S803C-B25	2CCS883001R0255	212742		0.735	1
	32	S803C-B32	2CCS883001R0325	212902		0.735	1
	40	S803C-B40	2CCS883001R0405	213060		0.735	1
	50	S803C-B50	2CCS883001R0505	213220		0.735	1
	63	S803C-B63	2CCS883001R0635	213381		0.735	1
	80	S803C-B80	2CCS883001R0805	213541		0.735	1
	100	S803C-B100	2CCS883001R0825	213701		0.735	1
	125	S803C-B125	2CCS883001R0845	213862		0.735	1
4	10	S804C-B10	2CCS884001R0105	212117		0.98	1
	13	S804C-B13	2CCS884001R0135	212278		0.98	1
	16	S804C-B16	2CCS884001R0165	212438		0.98	1
	20	S804C-B20	2CCS884001R0205	212599		0.98	1
	25	S804C-B25	2CCS884001R0255	212759		0.98	1
	32	S804C-B32	2CCS884001R0325	212919		0.98	1
	40	S804C-B40	2CCS884001R0405	213077		0.98	1
	50	S804C-B50	2CCS884001R0505	213237		0.98	1
	63	S804C-B63	2CCS884001R0635	213398		0.98	1
	80	S804C-B80	2CCS884001R0805	213558		0.98	1
	100	S804C-B100	2CCS884001R0825	213718		0.98	1
	125	S804C-B125	2CCS884001R0845	213879		0.98	1

C

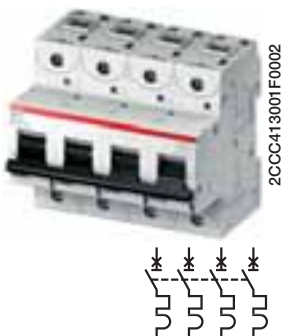
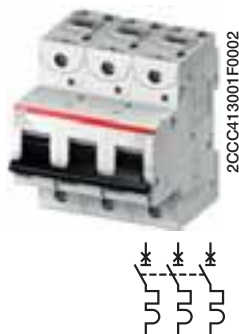

S800C-C characteristic

Function: protection and control of the circuits against overloads and short-circuits when a high breaking capacity is required; protection for people and big length cables in TN and IT systems; very useful when selectivity is needed vs an MCCB or back-up vs other MCBs wired downstream.

Applications: commercial and industrial.

Standard: IEC/EN 60947-2, IEC/EN 60898

Icn=15 kA

Icu=25 kA

Number of poles	Rated current In A	Order details Type code	Order code	Bbn	Price	Price	Weight	Pack
				7612271	1 piece	group	1 piece	unit
				EAN			kg	pc.
1	10	S801C-C10	2CCS881001R0104	212124			0.245	1
	13	S801C-C13	2CCS881001R0134	212285			0.245	1
	16	S801C-C16	2CCS881001R0164	212445			0.245	1
	20	S801C-C20	2CCS881001R0204	212605			0.245	1
	25	S801C-C25	2CCS881001R0254	212766			0.245	1
	32	S801C-C32	2CCS881001R0324	212926			0.245	1
	40	S801C-C40	2CCS881001R0404	213084			0.245	1
	50	S801C-C50	2CCS881001R0504	213244			0.245	1
	63	S801C-C63	2CCS881001R0634	213404			0.245	1
	80	S801C-C80	2CCS881001R0804	213565			0.245	1
	100	S801C-C100	2CCS881001R0824	213725			0.245	1
	125	S801C-C125	2CCS881001R0844	213886			0.245	1
2	10	S802C-C10	2CCS882001R0104	212131			0.49	1
	13	S802C-C13	2CCS882001R0134	212292			0.49	1
	16	S802C-C16	2CCS882001R0164	212452			0.49	1
	20	S802C-C20	2CCS882001R0204	212612			0.49	1
	25	S802C-C25	2CCS882001R0254	212773			0.49	1
	32	S802C-C32	2CCS882001R0324	212933			0.49	1
	40	S802C-C40	2CCS882001R0404	213091			0.49	1
	50	S802C-C50	2CCS882001R0504	213251			0.49	1
	63	S802C-C63	2CCS882001R0634	213411			0.49	1
	80	S802C-C80	2CCS882001R0804	213572			0.49	1
	100	S802C-C100	2CCS882001R0824	213732			0.49	1
	125	S802C-C125	2CCS882001R0844	213893			0.49	1
3	10	S803C-C10	2CCS883001R0104	212148			0.735	1
	13	S803C-C13	2CCS883001R0134	212308			0.735	1
	16	S803C-C16	2CCS883001R0164	212469			0.735	1
	20	S803C-C20	2CCS883001R0204	212629			0.735	1
	25	S803C-C25	2CCS883001R0254	212780			0.735	1
	32	S803C-C32	2CCS883001R0324	212940			0.735	1
	40	S803C-C40	2CCS883001R0404	213107			0.735	1
	50	S803C-C50	2CCS883001R0504	213268			0.735	1
	63	S803C-C63	2CCS883001R0634	213428			0.735	1
	80	S803C-C80	2CCS883001R0804	213589			0.735	1
	100	S803C-C100	2CCS883001R0824	213749			0.735	1
	125	S803C-C125	2CCS883001R0844	213909			0.735	1
4	10	S804C-C10	2CCS884001R0104	212155			0.98	1
	13	S804C-C13	2CCS884001R0134	212315			0.98	1
	16	S804C-C16	2CCS884001R0164	212476			0.98	1
	20	S804C-C20	2CCS884001R0204	212636			0.98	1
	25	S804C-C25	2CCS884001R0254	212797			0.98	1
	32	S804C-C32	2CCS884001R0324	212957			0.98	1
	40	S804C-C40	2CCS884001R0404	213114			0.98	1
	50	S804C-C50	2CCS884001R0504	213275			0.98	1
	63	S804C-C63	2CCS884001R0634	213435			0.98	1
	80	S804C-C80	2CCS884001R0804	213596			0.98	1
	100	S804C-C100	2CCS884001R0824	213756			0.98	1
	125	S804C-C125	2CCS884001R0844	213916			0.98	1

D

2



2CCC413001F0002



2CCC413001F0002



2CCC413001F0002



2CCC413001F0002



S800C-D characteristic

Function: protection and control of the circuits against overloads and short-circuits when a high breaking capacity is required; protection for people and big length cables in TN and IT systems; very useful when selectivity is needed vs an MCCB or back-up vs other MCBs wired downstream.

Applications: commercial and industrial.

Standard: IEC/EN 60947-2, IEC/EN 60898

Icn=15kA

Icu=25 kA

Number of poles	Rated current	Order details	Bbn	Price 1 piece	Price group	Weight 1 piece	Pack unit
In A	Type code	Order code	EAN			kg	pc.
1	10	S801C-D10	2CCS881001R0101	212162		0.245	1
	13	S801C-D13	2CCS881001R0131	212322		0.245	1
	16	S801C-D16	2CCS881001R0161	212483		0.245	1
	20	S801C-D20	2CCS881001R0201	212643		0.245	1
	25	S801C-D25	2CCS881001R0251	212803		0.245	1
	32	S801C-D32	2CCS881001R0321	212964		0.245	1
	40	S801C-D40	2CCS881001R0401	213121		0.245	1
	50	S801C-D50	2CCS881001R0501	213282		0.245	1
	63	S801C-D63	2CCS881001R0631	213442		0.245	1
	80	S801C-D80	2CCS881001R0801	213602		0.245	1
	100	S801C-D100	2CCS881001R0821	213763		0.245	1
	125	S801C-D125	2CCS881001R0841	213923		0.245	1
2	10	S802C-D10	2CCS882001R0101	212179		0.49	1
	13	S802C-D13	2CCS882001R0131	212339		0.49	1
	16	S802C-D16	2CCS882001R0161	212490		0.49	1
	20	S802C-D20	2CCS882001R0201	212650		0.49	1
	25	S802C-D25	2CCS882001R0251	212810		0.49	1
	32	S802C-D32	2CCS882001R0321	212971		0.49	1
	40	S802C-D40	2CCS882001R0401	213138		0.49	1
	50	S802C-D50	2CCS882001R0501	213299		0.49	1
	63	S802C-D63	2CCS882001R0631	213459		0.49	1
	80	S802C-D80	2CCS882001R0801	213619		0.49	1
	100	S802C-D100	2CCS882001R0821	213770		0.49	1
	125	S802C-D125	2CCS882001R0841	213930		0.49	1
3	10	S803C-D10	2CCS883001R0101	212186		0.735	1
	13	S803C-D13	2CCS883001R0131	212346		0.735	1
	16	S803C-D16	2CCS883001R0161	212506		0.735	1
	20	S803C-D20	2CCS883001R0201	212667		0.735	1
	25	S803C-D25	2CCS883001R0251	212827		0.735	1
	32	S803C-D32	2CCS883001R0321	212988		0.735	1
	40	S803C-D40	2CCS883001R0401	213145		0.735	1
	50	S803C-D50	2CCS883001R0501	213305		0.735	1
	63	S803C-D63	2CCS883001R0631	213466		0.735	1
	80	S803C-D80	2CCS883001R0801	213626		0.735	1
	100	S803C-D100	2CCS883001R0821	213787		0.735	1
	125	S803C-D125	2CCS883001R0841	213947		0.735	1
4	10	S804C-D10	2CCS884001R0101	212193		0.98	1
	13	S804C-D13	2CCS884001R0131	212353		0.98	1
	16	S804C-D16	2CCS884001R0161	212513		0.98	1
	20	S804C-D20	2CCS884001R0201	212674		0.98	1
	25	S804C-D25	2CCS884001R0251	212834		0.98	1
	32	S804C-D32	2CCS884001R0321	212995		0.98	1
	40	S804C-D40	2CCS884001R0401	213152		0.98	1
	50	S804C-D50	2CCS884001R0501	213312		0.98	1
	63	S804C-D63	2CCS884001R0631	213473		0.98	1
	80	S804C-D80	2CCS884001R0801	213633		0.98	1
	100	S804C-D100	2CCS884001R0821	213794		0.98	1
	125	S804C-D125	2CCS884001R0841	213954		0.98	1

K

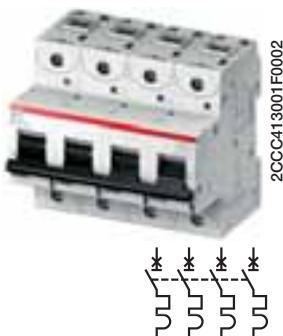
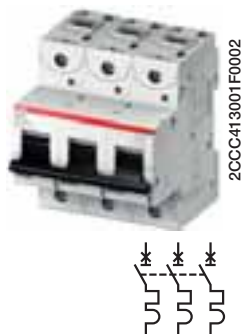

S800C-K characteristic

Function: protection and control of the circuits against overloads and short-circuits when a high breaking capacity is required; protection for people and big length cables in TN and IT systems; very useful when selectivity is needed vs an MCCB or back-up vs other MCBs wired downstream.

Applications: commercial and industrial.

Standard: IEC/EN 60947-2

Icu=25 kA

Number of poles	Rated current In A	Order details Type code	Order code	Bbn 7612271 EAN	Price 1 piece	Price group	Weight 1 piece kg	Pack unit pc.
1	10	S801C-K10	2CCS881001R0427	212209			0.245	1
	13	S801C-K13	2CCS881001R0447	212360			0.245	1
	16	S801C-K16	2CCS881001R0467	212520			0.245	1
	20	S801C-K20	2CCS881001R0487	212681			0.245	1
	25	S801C-K25	2CCS881001R0517	212841			0.245	1
	32	S801C-K32	2CCS881001R0537	213008			0.245	1
	40	S801C-K40	2CCS881001R0557	213169			0.245	1
	50	S801C-K50	2CCS881001R0577	213329			0.245	1
	63	S801C-K63	2CCS881001R0597	213480			0.245	1
	80	S801C-K80	2CCS881001R0627	213640			0.245	1
	100	S801C-K100	2CCS881001R0637	213800			0.245	1
	125	S801C-K125	2CCS881001R0647	213961			0.245	1
2	10	S802C-K10	2CCS882001R0427	212216			0.49	1
	13	S802C-K13	2CCS882001R0447	212377			0.49	1
	16	S802C-K16	2CCS882001R0467	212537			0.49	1
	20	S802C-K20	2CCS882001R0487	212698			0.49	1
	25	S802C-K25	2CCS882001R0517	212858			0.49	1
	32	S802C-K32	2CCS882001R0537	213015			0.49	1
	40	S802C-K40	2CCS882001R0557	213176			0.49	1
	50	S802C-K50	2CCS882001R0577	213336			0.49	1
	63	S802C-K63	2CCS882001R0597	213497			0.49	1
	80	S802C-K80	2CCS882001R0627	213657			0.49	1
	100	S802C-K100	2CCS882001R0637	213817			0.49	1
	125	S802C-K125	2CCS882001R0647	213978			0.49	1
3	10	S803C-K10	2CCS883001R0427	212223			0.735	1
	13	S803C-K13	2CCS883001R0447	212384			0.735	1
	16	S803C-K16	2CCS883001R0467	212544			0.735	1
	20	S803C-K20	2CCS883001R0487	212704			0.735	1
	25	S803C-K25	2CCS883001R0517	212865			0.735	1
	32	S803C-K32	2CCS883001R0537	213022			0.735	1
	40	S803C-K40	2CCS883001R0557	213183			0.735	1
	50	S803C-K50	2CCS883001R0577	213343			0.735	1
	63	S803C-K63	2CCS883001R0597	213503			0.735	1
	80	S803C-K80	2CCS883001R0627	213664			0.735	1
	100	S803C-K100	2CCS883001R0637	213824			0.735	1
	125	S803C-K125	2CCS883001R0647	213985			0.735	1
4	10	S804C-K10	2CCS884001R0427	212230			0.98	1
	13	S804C-K13	2CCS884001R0447	212391			0.98	1
	16	S804C-K16	2CCS884001R0467	212551			0.98	1
	20	S804C-K20	2CCS884001R0487	212711			0.98	1
	25	S804C-K25	2CCS884001R0517	212872			0.98	1
	32	S804C-K32	2CCS884001R0537	213039			0.98	1
	40	S804C-K40	2CCS884001R0557	213190			0.98	1
	50	S804C-K50	2CCS884001R0577	213350			0.98	1
	63	S804C-K63	2CCS884001R0597	213510			0.98	1
	80	S804C-K80	2CCS884001R0627	213671			0.98	1
	100	S804C-K100	2CCS884001R0637	213831			0.98	1
	125	S804C-K125	2CCS884001R0647	213992			0.98	1

Z

2



2CCC413001F0002



2CCC413001F0002



2CCC413001F0002



2CCC413001F0002



S800U-Z characteristic

Function: protection and control of the circuits against overloads and short-circuits when a high breaking capacity is required; protection for people and big length cables in TN and IT systems; very useful when selectivity is needed vs an MCCB or back-up vs other MCBs wired downstream.

Applications: commercial and industrial.

Standard: UL489, CSA 22.2 NO.5-02, IEC/EN 60947-2

Icu=30 kA (1 pole), 50 kA (2...4 poles)

Number of poles	Rated current In A	Order details Type code	Order code	Bbn	Price	Price	Weight	Pack
				7612271	1 piece	group	1 piece	unit
				EAN			kg	pc.
1	10	S801U-Z10	2CCS881017R0105	214487			0.245	1
	15	S801U-Z15	2CCS881017R0155	214524			0.245	1
	20	S801U-Z20	2CCS881017R0205	214562			0.245	1
	25	S801U-Z25	2CCS881017R0255	214609			0.245	1
	30	S801U-Z30	2CCS881017R0305	214647			0.245	1
	40	S801U-Z40	2CCS881017R0405	214685			0.245	1
	50	S801U-Z50	2CCS881017R0505	214722			0.245	1
	60	S801U-Z60	2CCS881017R0605	214760			0.245	1
	70	S801U-Z70	2CCS881017R0705	214807			0.245	1
	80	S801U-Z80	2CCS881017R0805	214845			0.245	1
	90	S801U-Z90	2CCS881017R0905	214883			0.245	1
100	S801U-Z100	2CCS881017R0825	214920			0.245	1	
2	10	S802U-Z10	2CCS862017R0105	214494			0.49	1
	15	S802U-Z15	2CCS862017R0155	214531			0.49	1
	20	S802U-Z20	2CCS862017R0205	214579			0.49	1
	25	S802U-Z25	2CCS862017R0255	214616			0.49	1
	30	S802U-Z30	2CCS862017R0305	214654			0.49	1
	40	S802U-Z40	2CCS862017R0405	214692			0.49	1
	50	S802U-Z50	2CCS862017R0505	214739			0.49	1
	60	S802U-Z60	2CCS862017R0605	214777			0.49	1
	70	S802U-Z70	2CCS862017R0705	214814			0.49	1
	80	S802U-Z80	2CCS862017R0805	214852			0.49	1
	90	S802U-Z90	2CCS862017R0905	214890			0.49	1
100	S802U-Z100	2CCS862017R0825	214937			0.49	1	
3	10	S803U-Z10	2CCS863017R0105	214500			0.735	1
	15	S803U-Z15	2CCS863017R0155	214548			0.735	1
	20	S803U-Z20	2CCS863017R0205	214586			0.735	1
	25	S803U-Z25	2CCS863017R0255	214623			0.735	1
	30	S803U-Z30	2CCS863017R0305	214661			0.735	1
	40	S803U-Z40	2CCS863017R0405	214708			0.735	1
	50	S803U-Z50	2CCS863017R0505	214746			0.735	1
	60	S803U-Z60	2CCS863017R0605	214784			0.735	1
	70	S803U-Z70	2CCS863017R0705	214821			0.735	1
	80	S803U-Z80	2CCS863017R0805	214869			0.735	1
	90	S803U-Z90	2CCS863017R0905	214906			0.735	1
100	S803U-Z100	2CCS863017R0825	214944			0.735	1	
4	10	S804U-Z10	2CCS864017R0105	214517			0.98	1
	15	S804U-Z15	2CCS864017R0155	214555			0.98	1
	20	S804U-Z20	2CCS864017R0205	214593			0.98	1
	25	S804U-Z25	2CCS864017R0255	214630			0.98	1
	30	S804U-Z30	2CCS864017R0305	214678			0.98	1
	40	S804U-Z40	2CCS864017R0405	214715			0.98	1
	50	S804U-Z50	2CCS864017R0505	214753			0.98	1
	60	S804U-Z60	2CCS864017R0605	214791			0.98	1
	70	S804U-Z70	2CCS864017R0705	214838			0.98	1
	80	S804U-Z80	2CCS864017R0805	214876			0.98	1
	90	S804U-Z90	2CCS864017R0905	214913			0.98	1
100	S804U-Z100	2CCS864017R0825	214951			0.98	1	

K

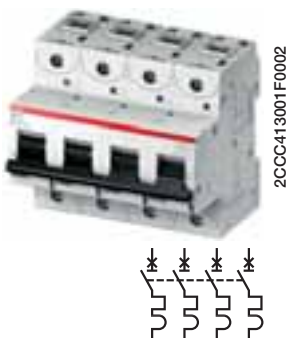
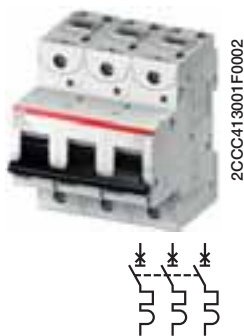

S800U-K characteristic

Function: protection and control of the circuits against overloads and short-circuits when a high breaking capacity is required; protection for people and big length cables in TN and IT systems; very useful when selectivity is needed vs an MCCB or back-up vs other MCBs wired downstream.

Applications: commercial and industrial.

Standard: UL489, CSA 22.2 NO.5-02, IEC/EN 60947-2

Icu=30 kA (1-pole), 50 kA (2...4-pole)

Number of poles	Rated current	Order details	Bbn 7612271	Price 1 piece	Price group	Weight 1 piece	Pack unit
	In A	Type code	Order code	EAN		kg	pc.
1	10	S801U-K10	2CCS881017R0427	214005		0.245	1
	15	S801U-K15	2CCS881017R0457	214043		0.245	1
	20	S801U-K20	2CCS881017R0487	214081		0.245	1
	25	S801U-K25	2CCS881017R0517	214128		0.245	1
	30	S801U-K30	2CCS881017R0527	214166		0.245	1
	40	S801U-K40	2CCS881017R0557	214203		0.245	1
	50	S801U-K50	2CCS881017R0577	214241		0.245	1
	60	S801U-K60	2CCS881017R0587	214289		0.245	1
	70	S801U-K70	2CCS881017R0707	214326		0.245	1
	80	S801U-K80	2CCS881017R0627	214364		0.245	1
90	S801U-K90	2CCS881017R0907	214401		0.245	1	
100	S801U-K100	2CCS881017R0637	214449		0.245	1	
2	10	S802U-K10	2CCS862017R0427	214012		0.49	1
	15	S802U-K15	2CCS862017R0457	214050		0.49	1
	20	S802U-K20	2CCS862017R0487	214098		0.49	1
	25	S802U-K25	2CCS862017R0517	214135		0.49	1
	30	S802U-K30	2CCS862017R0527	214173		0.49	1
	40	S802U-K40	2CCS862017R0557	214210		0.49	1
	50	S802U-K50	2CCS862017R0577	214258		0.49	1
	60	S802U-K60	2CCS862017R0587	214296		0.49	1
	70	S802U-K70	2CCS862017R0707	214333		0.49	1
	80	S802U-K80	2CCS862017R0627	214371		0.49	1
90	S802U-K90	2CCS862017R0907	214418		0.49	1	
100	S802U-K100	2CCS862017R0637	214456		0.49	1	
3	10	S803U-K10	2CCS863017R0427	214029		0.735	1
	15	S803U-K15	2CCS863017R0457	214067		0.735	1
	20	S803U-K20	2CCS863017R0487	214104		0.735	1
	25	S803U-K25	2CCS863017R0517	214142		0.735	1
	30	S803U-K30	2CCS863017R0527	214180		0.735	1
	40	S803U-K40	2CCS863017R0557	214227		0.735	1
	50	S803U-K50	2CCS863017R0577	214265		0.735	1
	60	S803U-K60	2CCS863017R0587	214302		0.735	1
	70	S803U-K70	2CCS863017R0707	214340		0.735	1
	80	S803U-K80	2CCS863017R0627	214388		0.735	1
90	S803U-K90	2CCS863017R0907	214425		0.735	1	
100	S803U-K100	2CCS863017R0637	214463		0.735	1	
4	10	S804U-K10	2CCS864017R0427	214036		0.98	1
	15	S804U-K15	2CCS864017R0457	214074		0.98	1
	20	S804U-K20	2CCS864017R0487	214111		0.98	1
	25	S804U-K25	2CCS864017R0517	214159		0.98	1
	30	S804U-K30	2CCS864017R0527	214197		0.98	1
	40	S804U-K40	2CCS864017R0557	214234		0.98	1
	50	S804U-K50	2CCS864017R0577	214272		0.98	1
	60	S804U-K60	2CCS864017R0587	214319		0.98	1
	70	S804U-K70	2CCS864017R0707	214357		0.98	1
	80	S804U-K80	2CCS864017R0627	214395		0.98	1
90	S804U-K90	2CCS864017R0907	214432		0.98	1	
100	S804U-K100	2CCS864017R0637	214470		0.98	1	

PV-S

2



2CCP413001F0002



2CCP413001F0002



2CCP413001F0002



S800PV-S characteristic

Function: protection and control of photovoltaic strings against overloads and short-circuits. Ideal replacement for fuses due to comfortable string failure identification and signalisation.

Applications: Photovoltaic systems.

Standard: IEC 60947-2

Icu=5 kA

Number of poles	Rated current	Order details		Bbn 7612271	Price 1 piece	Price group	Weight 1 piece	Pack unit
In A	Type code	Order code		EAN			kg	pc.
2	10	S802PV-S10	2CCP842001R1109	210939			0.49	1
	13	S802PV-S13	2CCP842001R1139	210946			0.49	1
	16	S802PV-S16	2CCP842001R1169	210953			0.49	1
	20	S802PV-S20	2CCP842001R1209	210960			0.49	1
	25	S802PV-S25	2CCP842001R1259	210977			0.49	1
	32	S802PV-S32	2CCP842001R1329	210984			0.49	1
	40	S802PV-S40	2CCP842001R1409	210991			0.49	1
	50	S802PV-S50	2CCP842001R1509	211004			0.49	1
	63	S802PV-S63	2CCP842001R1639	211011			0.49	1
	80	S802PV-S80	2CCP842001R1809	211028			0.49	1
	100	S802PV-S100	2CCP842001R1829	214968			0.49	1
	125	S802PV-S125	2CCP842001R1849	214999			0.49	1
3	10	S803PV-S10	2CCP843001R1109	211035			0.735	1
	13	S803PV-S13	2CCP843001R1139	211042			0.735	1
	16	S803PV-S16	2CCP843001R1169	211059			0.735	1
	20	S803PV-S20	2CCP843001R1209	211066			0.735	1
	25	S803PV-S25	2CCP843001R1259	211073			0.735	1
	32	S803PV-S32	2CCP843001R1329	211080			0.735	1
	40	S803PV-S40	2CCP843001R1409	211097			0.735	1
	50	S803PV-S50	2CCP843001R1509	211103			0.735	1
	63	S803PV-S63	2CCP843001R1639	211110			0.735	1
	80	S803PV-S80	2CCP843001R1809	211127			0.735	1
	100	S803PV-S100	2CCP843001R1829	214975			0.740	1
	125	S803PV-S125	2CCP843001R1849	215002			0.740	1
4	10	S804PV-S10	2CCP844001R1109	211134			0.98	1
	13	S804PV-S13	2CCP844001R1139	211141			0.98	1
	16	S804PV-S16	2CCP844001R1169	211158			0.98	1
	20	S804PV-S20	2CCP844001R1209	211165			0.98	1
	25	S804PV-S25	2CCP844001R1259	211172			0.98	1
	32	S804PV-S32	2CCP844001R1329	211189			0.98	1
	40	S804PV-S40	2CCP844001R1409	211196			0.98	1
	50	S804PV-S50	2CCP844001R1509	211202			0.98	1
	63	S804PV-S63	2CCP844001R1639	211219			0.98	1
	80	S804PV-S80	2CCP844001R1809	211226			0.98	1
	100	S804PV-S100	2CCP844001R1829	214982			0.98	1
	125	S804PV-S125	2CCP844001R1849	215019			0.98	1

S800PV-M

Function: DC main switch for photovoltaic applications. Safe disconnection of photovoltaic arrays.

Applications: Photovoltaic systems.

Standard: IEC 60947-3

Icw=1.5 kA



2CCC413001F0002



2CCC413001F0002



2CCC413001F0002

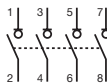

Number of poles	Rated current In A	Order details Type code	Order code	Bbn 7612271 EAN	Price 1 piece	Price group	Weight 1 piece kg	Pack unit pc.
2	32	S802PV-M32	2CCP812001R1329	211233			0.43	1
	63	S802PV-M63	2CCD842001R1590	215026			0.65	1
	125	S802PV-M125	2CCP812001R1849	211240			0.43	1

3	32	S803PV-M32	2CCP813001R1329	211257			0.65	1
	63	S803PV-M63	2CCD843001R1590	215033			0.65	1
	125	S803PV-M125	2CCP813001R1849	211264			0.65	1

4	32	S804PV-M32	2CCP814001R1329	211271			0.86	1
	63	S804PV-M63	2CCD844001R1590	215040			0.86	1
	125	S804PV-M125	2CCP814001R1849	211288			0.86	1



TECHNICAL FEATURES			S500-K
Standards			IEC/EN 60947-2, UL 1077 ①, CAN/CSA-C22.2 No. 35
Rated current I_n			adjustable 0.1 ≤ I _n ≤ 3 / 2.8 ≤ I _n ≤ 11 / 10 ≤ I _n ≤ 45
Poles			1, 2, 3+N, NA
Rated voltage U_e	IEC AC	V	230/400; 250/440; 3x500; 400/690
	UL/CSA AC	V	240/415; 277/480; 346/600
Insulation voltage U_i			690
Max. operating voltage U_b max.	IEC AC	V	400/690
	UL/CSA AC	V	600 Y/346
Rated frequency			16 2/3, 50/60
Rated breaking capacity acc. to IEC/EN 60947-2	ultimate I _{cu}	kA	100 (0.1 - 3A) 50 (2.8 - 11A) 30 (10 - 45A)
1P @ 230 VAC			
2P, 3P, 4P@ 400 VAC			
Rated interrupting capacity acc. to UL1077, CSA22.2	service I _{cs}	kA	100 (0.1 - 3A) 30 (2.8 - 11A) 25 (10 - 45A)
	IR	kA	14
No.35 1P@277 VAC			
2P,3P,4P@480 VAC			
Rated impulse withstand voltage (1.2/50) U_{imp}			6
Overvoltage category			
Thermomagnetic release K: 8 I_n ≤ I_m ≤ 14 I_n characteristic			■
Toggle			grey sealable in ON-OFF position
Protection degree	housing		IP4X
	terminals		IP2X
Tropicalization acc. to IEC/EN 60068-2	humid heat	°C/RH	DIN 50016
Reference temperature for setting of thermal element			40
Ambient temperature (with daily average ≤ +35 °C)			-25...+55
Terminal type			cage (shock protected)
Terminal size top/bottom for cable			
	IEC	mm ²	1 ... 25
	UL/CSA	AWG	17
Tightening torque			2.5
Mounting			on DIN rail EN 60715
Connection			from top and bottom
Pole dimensions (H x D x W)			91 x 92 x 25
Pole weight			250
Combinable with:	signal contact/auxiliary switch		yes
	shunt trip		yes
	undervoltage release		yes (factory fitted)
	mechanical interlock		no
	motor operating device		no

① supplementary protection



TECHNICAL FEATURES			S500UC-K
Standards			IEC/EN 60947-2, UL 1077 ①, CAN/CSA-C22.2 ① No. 35
Rated current I_n		A	adjustable 0.1 ≤ I _n ≤ 3 / 2.8 ≤ I _n ≤ 11 / 10 ≤ I _n ≤ 45
Poles			1 ... 4
Rated voltage U_e	DC	V	250 per pole (4P 750V)
Insulation voltage U_i		V	1000 VDC
Max. operating voltage U_{b max.}	DC	V	250 per pole (4P 750V)
Rated breaking capacity acc. to IEC/EN 60947-2 1P@ 250 VDC 2P@500 VDC 3P, 4P@ 750 VDC	ultimate I _{cu}	kA	30
Rated interrupting capacity acc. to UL1077, CSA22.2 No.235 1P@60 VDC 2P, 3P, 4P@125 VDC	IR	kA	30
Rated impulse withstand voltage U_{imp}		kV	6
Overvoltage category			■
Thermomagnetic release characteristic	K: 8 I _n ≤ I _m ≤ 14 I _n		
Toggle			grey sealable in ON-OFF position
Protection degree	housing		IP4X
	terminals		IP2X
Tropicalization acc. to IEC/EN 60068-2	humid heat	°C/RH	DIN 50016
Reference temperature for setting of thermal element		°C	40
Ambient temperature (with daily average ≤ +35 °C)		°C	-25...+55
Terminal type			cage (shock protected)
Terminal size top/bottom for cable	IEC	mm ²	1 ... 25
	UL/CSA	AWG	17-4
Tightening torque	IEC	Nm	2.5
Tool			Nr. 2 Posidriv
Mounting			on DIN rail EN 60715
Connection			from top and bottom
Pole dimensions (H x D x W)		mm	91 x 92 x 25
Pole weight		g	250
Combinable with:	signal contact/auxiliary switch		yes
	shunt trip		yes
	undervoltage release		yes (factory fitted)
	mechanical interlock		no
	motor operating device		no

① supplementary protection

K

2

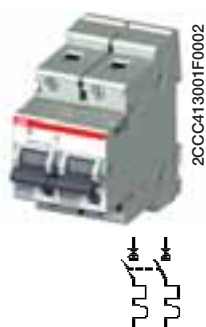

S500-K (power) characteristic

Function: protection and control of the circuits like motors, transformer and auxiliary circuits, against overloads and short-circuits when an high breaking capacity is required; very useful when it is needed selectivity vs an MCCB or back-up vs other MCBs wired downstream; version with adjustable thermal release, dedicated to protect motors.

Advantages: No nuisance tripping in the case of functional peak currents up to 8xI_n, depending on the series; through its highly sensitive thermostatic bimetal trip, the K-type characteristic offers protection to damageable elements in the overcurrent range; it also provides the best protection to cables and lines.

Applications: commercial and industrial.

Standard: IEC/EN 60947-2, UL 1077

Icu up to 100 kA

Number of poles	Rated current	Order details	Bbn 7612270	Price 1 piece	Price group	Weight 1 piece kg	Pack unit pc.
In A	Type code	Order code	EAN				
1	0.1-0.15	S501 K0.1 - 0.15	2CCF008856R0001	303007		0.250	1
	0.14-0.21	S501 K0.14 - 0.21	2CCF008857R0001	303014		0.250	1
	0.2-0.3	S501 K0.2 - 0.3	2CCF008858R0001	303021		0.250	1
	0.28-0.42	S501 K0.28 - 0.42	2CCF008859R0001	303038		0.250	1
	0.38-0.58	S501 K0.38 - 0.58	2CCF008860R0001	303045		0.250	1
	0.53-0.8	S501 K0.53 - 0.8	2CCF008861R0001	303052		0.250	1
	0.73-1.1	S501 K0.73 - 1.1	2CCF008862R0001	303069		0.250	1
	1-1.5	S501 K1 - 1.5	2CCF008863R0001	303076		0.250	1
	1.4-2.1	S501 K1.4 - 2.1	2CCF008864R0001	303083		0.250	1
	2-3	S501 K2-3	2CCF008865R0001	303090		0.250	1
	2.8-4.2	S501 K2.8 - 4.2	2CCF008866R0001	303106		0.250	1
	3.8-5.8	S501 K3.8 - 5.8	2CCF008867R0001	303113		0.250	1
	5.3-8	S501 K5.3 - 8	2CCF008868R0001	303120		0.250	1
	7.3-11	S501 K7.3 - 11	2CCF008869R0001	303137		0.250	1
	10-15	S501 K10 - 15	2CCF008870R0001	303144		0.250	1
	14-20	S501 K14 - 20	2CCF008871R0001	303151		0.250	1
	18-26	S501 K18 - 26	2CCF008872R0001	303168		0.250	1
	23-32	S501 K23 - 32	2CCF008873R0001	303175		0.250	1
	29-37	S501 K29 - 37	2CCF008874R0001	303182		0.250	1
34-41	S501 K34 - 41	2CCF008877R0001	303199		0.250	1	
38-45	S501 K38 - 45	2CCF008888R0001	303205		0.250	1	
2	0.1-0.15	S502 K0.1 - 0.15	2CCF008894R0001	303250		0.500	1
	0.14-0.21	S502 K0.14 - 0.21	2CCF008895R0001	303267		0.500	1
	0.2-0.3	S502 K0.2 - 0.3	2CCF008896R0001	303274		0.500	1
	0.28-0.42	S502 K0.28 - 0.42	2CCF008897R0001	303281		0.500	1
	0.38-0.58	S502 K0.38 - 0.58	2CCF008898R0001	303298		0.500	1
	0.53-0.8	S502 K0.53 - 0.8	2CCF008899R0001	303304		0.500	1
	0.73-1.1	S502 K0.73 - 1.1	2CCF008900R0001	303311		0.500	1
	1-1.5	S502 K1 - 1.5	2CCF008901R0001	303328		0.500	1
	1.4-2.1	S502 K1.4 - 2.1	2CCF008902R0001	303335		0.500	1
	2-3	S502 K2-3	2CCF008903R0001	303342		0.500	1
	2.8-4.2	S502 K2.8 - 4.2	2CCF008904R0001	303359		0.500	1
	3.8-5.8	S502 K3.8 - 5.8	2CCF008905R0001	303366		0.500	1
	5.3-8	S502 K5.3 - 8	2CCF008906R0001	303373		0.500	1
	7.3-11	S502 K7.3 - 11	2CCF008907R0001	303380		0.500	1
	10-15	S502 K10 - 15	2CCF008908R0001	303397		0.500	1
	14-20	S502 K14 - 20	2CCF008909R0001	303403		0.500	1
	18-26	S502 K18 - 26	2CCF008910R0001	303410		0.500	1
	23-32	S502 K23 - 32	2CCF008911R0001	303427		0.500	1
	29-37	S502 K29 - 37	2CCF008912R0001	303434		0.500	1
34-41	S502 K34 - 41	2CCF008913R0001	303441		0.500	1	
38-45	S502 K38 - 45	2CCF008926R0001	303458		0.500	1	

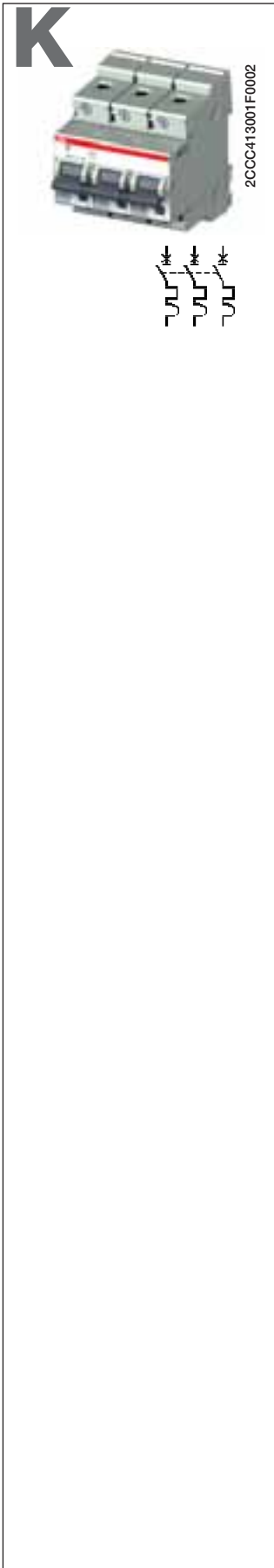

3	0.1-0.15	S503 K0.1 - 0.15	2CCF008932R0001	303502	0.750	1
	0.14-0.21	S503 K0.14 - 0.21	2CCF008933R0001	303519	0.750	1
	0.2-0.3	S503 K0.2 - 0.3	2CCF008934R0001	303526	0.750	1
	0.28-0.42	S503 K0.28 - 0.42	2CCF008935R0001	303533	0.750	1
	0.38-0.58	S503 K0.38 - 0.58	2CCF008936R0001	303540	0.750	1
	0.53-0.8	S503 K0.53 - 0.8	2CCF008937R0001	303557	0.750	1
	0.73-1.1	S503 K0.73 - 1.1	2CCF008938R0001	303564	0.750	1
	1-1.5	S503 K1 - 1.5	2CCF008939R0001	303571	0.750	1
	1.4-2.1	S503 K1.4 - 2.1	2CCF008940R0001	303588	0.750	1
	2-3	S503 K2-3	2CCF008941R0001	303595	0.750	1
	2.8-4.2	S503 K2.8 - 4.2	2CCF008942R0001	303601	0.750	1
	3.8-5.8	S503 K3.8 - 5.8	2CCF008943R0001	303618	0.750	1
	5.3-8	S503 K5.3 - 8	2CCF008944R0001	303625	0.750	1
	7.3-11	S503 K7.3 - 11	2CCF008945R0001	303632	0.750	1
	10-15	S503 K10 - 15	2CCF008946R0001	303649	0.750	1
	14-20	S503 K14 - 20	2CCF008947R0001	303656	0.750	1
	18-26	S503 K18 - 26	2CCF008948R0001	303663	0.750	1
	23-32	S503 K23 - 32	2CCF008949R0001	303670	0.750	1
	29-37	S503 K29 - 37	2CCF008950R0001	303687	0.750	1
	34-41	S503 K34 - 41	2CCF008951R0001	303694	0.750	1
38-45	S503 K38 - 45	2CCF008964R0001	303700	0.750	1	
4	0.1-0.15	S504UC-K0,15	2CCF011771R0001	302758	0,92	1
	0.14-0.21	S504UC-K0,21	2CCF011772R0001	302765	0,92	1
	0.2-0.3	S504UC-K0,3	2CCF011576R0001	302772	0,92	1
	0.28-0.42	S504UC-K0,42	2CCF011773R0001	302789	0,92	1
	0.38-0.58	S504UC-K0,58	2CCF011774R0001	302796	0,92	1
	0.53-0.8	S504UC-K0,8	2CCF011775R0001	302802	0,92	1
	0.73-1.1	S504UC-K1,1	2CCF011776R0001	302819	0,92	1
	1-1.5	S504UC-K1,5	2CCF011777R0001	302826	0,92	1
	1.4-2.1	S504UC-K2,1	2CCF011778R0001	302833	0,92	1
	2-3	S504UC-K3	2CCF011779R0001	302840	0,92	1
	2.8-4.2	S504UC-K4,2	2CCF011780R0001	302857	0,92	1
	3.8-5.8	S504UC-K5,8	2CCF011781R0001	302864	0,92	1
	5.3-8	S504UC-K8	2CCF011782R0001	302871	0,92	1
	7.3-11	S504UC-K11	2CCF011509R0001	302888	0,92	1
	10-15	S504UC-K15	2CCF011783R0001	302895	0,92	1
	14-20	S504UC-K20	2CCF011784R0001	302901	0,92	1
	18-26	S504UC-K26	2CCF011785R0001	302918	0,92	1
	23-32	S504UC-K32	2CCF011786R0001	302925	0,92	1
	29-37	S504UC-K37	2CCF011787R0001	302932	0,92	1
	34-41	S504UC-K41	2CCF011788R0001	302949	0,92	1
38-45	S504UC-K45	2CCF011789R0001	302956	0,92	1	

Note: from 5 to 6 poles available upon request

K

2



S500UC series K (power) characteristic

Function: protection and control of the circuits like motors, transformer and auxiliary circuits, against overloads and short-circuits when an high breaking capacity is required; very useful when it is needed selectivity vs an MCCB or back-up vs other MCBs wired downstream; version with adjustable thermal release, dedicated to protect motors; version dedicated to application in direct current circuits.

Advantages: No nuisance tripping in the case of functional peak currents up to $8 \times I_n$, depending on the series; through its highly sensitive thermostatic bimetal trip, the K-type characteristic offers protection to damageable elements in the overcurrent range; it also provides the best protection to cables and lines.

Applications: commercial and industrial.

Standard: IEC/EN 60947-2, UL1077

Icu up to 30 kA

Number of poles	Rated current	Order details	Bbn 7612270	Price 1 piece	Price group	Weight 1 piece	Pack unit
In A	Type code	Order code	EAN			kg	pc.
1	0.1-0.15	S501 UC-K0.1 - 0.15	2CCF008988R0001	302000		0.250	1
	0.14-0.21	S501 UC-K0.14 - 0.21	2CCF008991R0001	302017		0.250	1
	0.2-0.3	S501 UC-K0.2 - 0.3	2CCF008994R0001	302024		0.250	1
	0.28-0.42	S501 UC-K0.28 - 0.42	2CCF008997R0001	302031		0.250	1
	0.38-0.58	S501 UC-K0.38 - 0.58	2CCF009000R0001	302048		0.250	1
	0.53-0.8	S501 UC-K0.53 - 0.8	2CCF009003R0001	302055		0.250	1
	0.73-1.1	S501 UC-K0.73 - 1.1	2CCF009006R0001	302062		0.250	1
	1-1.5	S501 UC-K1 - 1.5	2CCF009009R0001	302079		0.250	1
	1.4-2.1	S501 UC-K1.4 - 2.1	2CCF009012R0001	302086		0.250	1
	2-3	S501 UC-K2-3	2CCF009015R0001	302093		0.250	1
	2.8-4.2	S501 UC-K2.8 - 4.2	2CCF009018R0001	302109		0.250	1
	3.8-5.8	S501 UC-K3.8 - 5.8	2CCF009021R0001	302116		0.250	1
	5.3-8	S501 UC-K5.3 - 8	2CCF009024R0001	302123		0.250	1
	7.3-11	S501 UC-K7.3 - 11	2CCF009027R0001	302130		0.250	1
	10-15	S501 UC-K10 - 15	2CCF009030R0001	302147		0.250	1
	14-20	S501 UC-K14 - 20	2CCF009033R0001	302154		0.250	1
	18-26	S501 UC-K18 - 26	2CCF009036R0001	302161		0.250	1
	23-32	S501 UC-K23 - 32	2CCF009039R0001	302178		0.250	1
	29-37	S501 UC-K29 - 37	2CCF009042R0001	302185		0.250	1
	34-41	S501 UC-K34 - 41	2CCF009045R0001	302192		0.250	1
38-45	S501 UC-K38 - 45	2CCF009048R0001	302208		0.250	8	
2	0.1-0.15	S502 UC-K0.1 - 0.15	2CCF008989R0001	302253		0.500	1
	0.14-0.21	S502 UC-K0.14 - 0.21	2CCF008992R0001	302260		0.500	1
	0.2-0.3	S502 UC-K0.2 - 0.3	2CCF008995R0001	302277		0.500	1
	0.28-0.42	S502 UC-K0.28 - 0.42	2CCF008998R0001	302284		0.500	1
	0.38-0.58	S502 UC-K0.38 - 0.58	2CCF009001R0001	302291		0.500	1
	0.53-0.8	S502 UC-K0.53 - 0.8	2CCF009004R0001	302307		0.500	1
	0.73-1.1	S502 UC-K0.73 - 1.1	2CCF009007R0001	302314		0.500	1
	1-1.5	S502 UC-K1 - 1.5	2CCF009010R0001	302321		0.500	1
	1.4-2.1	S502 UC-K1.4 - 2.1	2CCF009013R0001	302338		0.500	1
	2-3	S502 UC-K2-3	2CCF009016R0001	302345		0.500	1
	2.8-4.2	S502 UC-K2.8 - 4.2	2CCF009019R0001	302352		0.500	1
	3.8-5.8	S502 UC-K3.8 - 5.8	2CCF009022R0001	302369		0.500	1
	5.3-8	S502 UC-K5.3 - 8	2CCF009025R0001	302376		0.500	1
	7.3-11	S502 UC-K7.3 - 11	2CCF009028R0001	302383		0.500	1
	10-15	S502 UC-K10 - 15	2CCF009031R0001	302390		0.500	1
	14-20	S502 UC-K14 - 20	2CCF009034R0001	302406		0.500	1
	18-26	S502 UC-K18 - 26	2CCF009037R0001	302413		0.500	1
	23-32	S502 UC-K23 - 32	2CCF009040R0001	302420		0.500	1
	29-37	S502 UC-K29 - 37	2CCF009043R0001	302437		0.500	1
	34-41	S502 UC-K34 - 41	2CCF009046R0001	302444		0.500	1
38-45	S502 UC-K38 - 45	2CCF009049R0001	302451		0.500	1	

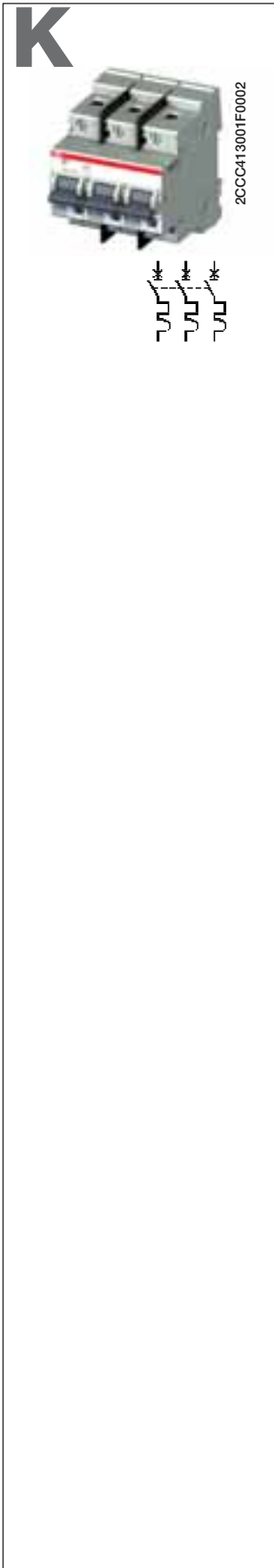

3	0.1-0.15	S503 UC-K0.1 - 0.15	2CCF008990R0001	302505	0.750	1
	0.14-0.21	S503 UC-K0.14 - 0.21	2CCF008993R0001	302512	0.750	1
	0.2-0.3	S503 UC-K0.2 - 0.3	2CCF008996R0001	302529	0.750	1
	0.28-0.42	S503 UC-K0.28 - 0.42	2CCF008999R0001	302536	0.750	1
	0.38-0.58	S503 UC-K0.38 - 0.58	2CCF009002R0001	302543	0.750	1
	0.53-0.8	S503 UC-K0.53 - 0.8	2CCF009005R0001	302550	0.750	1
	0.73-1.1	S503 UC-K0.73 - 1.1	2CCF009008R0001	302567	0.750	1
	1-1.5	S503 UC-K1 - 1.5	2CCF009011R0001	302574	0.750	1
	1.4-2.1	S503 UC-K1.4 - 2.1	2CCF009014R0001	302581	0.750	1
	2-3	S503 UC-K2-3	2CCF009017R0001	302598	0.750	1
	2.8-4.2	S503 UC-K2.8 - 4.2	2CCF009020R0001	302604	0.750	1
	3.8-5.8	S503 UC-K3.8 - 5.8	2CCF009023R0001	302611	0.750	1
	5.3-8	S503 UC-K5.3 - 8	2CCF009026R0001	302628	0.750	1
	7.3-11	S503 UC-K7.3 - 11	2CCF009029R0001	302635	0.750	1
	10-15	S503 UC-K10 - 15	2CCF009032R0001	302642	0.750	1
	14-20	S503 UC-K14 - 20	2CCF009035R0001	302659	0.750	1
	18-26	S503 UC-K18 - 26	2CCF009038R0001	302666	0.750	1
	23-32	S503 UC-K23 - 32	2CCF009041R0001	302673	0.750	1
	29-37	S503 UC-K29 - 37	2CCF009044R0001	302680	0.750	1
	34-41	S503 UC-K34 - 41	2CCF009047R0001	302697	0.750	1
38-45	S503 UC-K38 - 45	2CCF009050R0001	302703	0.750	1	
4	0.1-0.15	S504UC-K0,15	2CCF011771R0001	302758	0,92	1
	0.14-0.21	S504UC-K0,21	2CCF011772R0001	302765	0,92	1
	0.2-0.3	S504UC-K0,3	2CCF011576R0001	302772	0,92	1
	0.28-0.42	S504UC-K0,42	2CCF011773R0001	302789	0,92	1
	0.38-0.58	S504UC-K0,58	2CCF011774R0001	302796	0,92	1
	0.53-0.8	S504UC-K0,8	2CCF011775R0001	302802	0,92	1
	0.73-1.1	S504UC-K1,1	2CCF011776R0001	302819	0,92	1
	1-1.5	S504UC-K1,5	2CCF011777R0001	302826	0,92	1
	1.4-2.1	S504UC-K2,1	2CCF011778R0001	302833	0,92	1
	2-3	S504UC-K3	2CCF011779R0001	302840	0,92	1
	2.8-4.2	S504UC-K4,2	2CCF011780R0001	302857	0,92	1
	3.8-5.8	S504UC-K5,8	2CCF011781R0001	302864	0,92	1
	5.3-8	S504UC-K8	2CCF011782R0001	302871	0,92	1
	7.3-11	S504UC-K11	2CCF011509R0001	302888	0,92	1
	10-15	S504UC-K15	2CCF011783R0001	302895	0,92	1
	14-20	S504UC-K20	2CCF011784R0001	302901	0,92	1
	18-26	S504UC-K26	2CCF011785R0001	302918	0,92	1
	23-32	S504UC-K32	2CCF011786R0001	302925	0,92	1
	29-37	S504UC-K37	2CCF011787R0001	302932	0,92	1
	34-41	S504UC-K41	2CCF011788R0001	302949	0,92	1
38-45	S504UC-K45	2CCF011789R0001	302956	0,92	1	

Note: from 4 to 6 poles available upon request



2CSC400266F0201



2CSC400256F0201



2CSC400162F0201



2CSC400244F0201



2CSC400170F0201



Index

F 200, DDA 200, DS201, DS202C and DS 200 System pro <i>M</i> compact RCDs	3/2
DDA 60, 70, 90 for S 290 MCBs, DDA 800 RCD-blocks and DS800	3/61
DS 271 electronic RCBOs 1P+N	3/80
RD2, RD3, RD residual current relays and TR Toroidal Transformers	3/84

RCDs assure a protection to people and installations against fault current to earth. They are divided into three families:

- **RCCBs**, which are sensitive only to earth fault current (therefore they have to be connected in series with a MCB or a fuse to protect them against overcurrents and short-circuits)
- **RCD-blocks**, which are devices to be assembled on a MCB with lower or equal rated current to provide protection against both earth-fault currents and overload or short-circuits
- **RCBOs**, which combines in a single device protection against both earth-fault currents and overloads or short-circuits.

New RCDs System pro *M* compact® range presents a wide offer for all the three families, respectively **F 200**, **DDA 200** and **DS 200** series.

A large offer for standard instantaneous and selective AC and A types is completed with some configurations for special applications, like AP-R type against perturbations or AE type for emergency stop.

All sizes up to 63 A with all the sensitivity thresholds up to 1 A are offered in all the possible pole configurations.

The new **F200 PV B** is specifically designed for differential protect against earth-fault currents in photovoltaic installation.

ABB expands the offering of its System pro *M* compact® with new residual current circuitbreakers with overcurrent protection, **DS201** (1 phase + neutral) and **DS202C** (2 phases) both available in two modules.

The new residual current circuitbreakers with overcurrent protection are a technologically advanced and comprehensive range, as concerns size, tripping characteristics, breaking capacity and accessories.

DS201 and DS202C combine protection against overcurrent



and earth fault current in a single device.

DS201 and DS202C are equipped with clear indication flags.

The internal contact position allows an exact information of the circuit-breaker status: "green", open contacts; "red", closed contacts, independently of the toggle position. Any earth fault can be immediately identified through the blue indicator, that signals

the differential tripping and which cannot be activated in case of manual operation on the toggle.

With the practical label carrier fitted in the new circuitbreakers you can give maximum visibility to the information relating to the protected loads.

ABB RCDs obtained a lot of marks and approvals and offer the same "plus" advantages of the other System pro *M*

compact® devices. Residual current relays together with toroidal transformers can detect leakage current.

They are available in modular version (**RD2** range and the new **RD3** electronic residual current relay range) and in front panel versions (**RD** range).

A common range of **toroidal transformers** is available for all the residual current relays.



Residual current devices F 200, DDA 200 and DS 200 series

Index

RCCBs F 200 series

Technical features of RCCBs F 200 series	3/4
F 200 AC.....	3/6
F 200 AC (for overseas market).....	3/7
F 200 A	3/8
F 200 left neutral.....	3/9
F 200 AP-R AC	3/11
F 200 AP-R A.....	3/12
F 200 AC S	3/13
F 200 A S	3/14
F 200 A 400 Hz, F 200 A 16 2/3 Hz.....	3/15
F 200 B	3/16
F 200 PV B	3/18

RCD-blocks DDA 200 series

Technical features of RCD-blocks DDA 200 series	3/20
DDA 200 AC	3/22
DDA 200 A.....	3/23
DDA 200 special version 110 V and 400 V.....	3/24
DDA 200 AC AP-R.....	3/25
DDA 200 A AP-R	3/25
DDA 200 A AE	3/26
DDA 200 AC S.....	3/27
DDA 200 A S	3/28
DDA 200 B.....	3/29

RCBOs DS201 and DS202C series

Technical features of RCBOs DS201 series	3/30
DS201 L AC.....	3/32
DS201 L A	3/32
DS201 L APR.....	3/33
DS201 AC.....	3/34
DS201 APR.....	3/35
DS201 A	3/36
DS201 M AC.....	3/38
DS201 M APR	3/39
DS201 M A	3/40
Technical features of RCBOs DS202C series.....	3/42
DS202C A.....	3/44
DS202C M A.....	3/46
DS202C M APR.....	3/47

RCBOs DS 200 series

Technical features of RCBOs DS 200 series	3/48
DS 200 AC B	3/50
DS 200 AC C	3/51
DS 200 A B.....	3/52
DS 200 A C.....	3/53
DS 200 A K.....	3/54
DS 200 M AC B	3/55
DS 200 M AC C	3/56
DS 200 M A B.....	3/57
DS 200 M A C.....	3/58

3

TECHNICAL FEATURES			
	Standards		
Electrical features	Type (wave form of the earth leakage sensed)		
	Poles		
	Rated current I _n		A
	Rated sensitivity I _{Δn}		A
	Rated voltage U _e	IEC	V
		UL/CSA	V
	Insulation voltage U _i		V
	Max. operating voltage of circuit test	IEC	V
		UL/CSA	V
	Min. operating voltage of circuit test		V
	Rated frequency		Hz
	Rated conditional short-circuit current I _{nc} =I _{Δc}	SCPD - fuse gG 100 A	kA
			kA
	Rated impulse withstand voltage (1.2/50) U _{imp}		kV
	Dielectric test voltage at ind. freq. for 1 min.		kV
Overvoltage category			
Surge current resistance (wave 8/20)		A	
Mechanical features	Toggle		
	Contact position indicator (CPI)		
	Electrical life		
	Mechanical life		
	Protection degree	housing	
		terminals	
	Tropicalization	humid heat	°C/RH
	acc. to IEC/EN 60068-2	constant climatic conditions	°C/RH
		variable climatic conditions	°C/RH
	Ambient temperature (with daily average ≤ +35 °C)	IEC	°C
	UL/CSA	°C	
Storage temperature		°C	
Installation	Terminal type		
	Terminal size top/bottom for cable	IEC	mm ²
		UL/CSA	AWG
	Terminal size top/bottom for busbar	IEC	mm ²
		UL/CSA	AWG
	Tightening torque	IEC	N*m
		UL/CSA	in-lbs.
	Tool		
Mounting			
Connection			
Withdrawal from busbar			
Dimensions and weight	Dimensions (H x D x W)	2P	mm
		4P	mm
	Weight	2P	g
		4P	g
Combination with auxiliary elements	Combinable with:	auxiliary contact	
		signal contact/auxiliary switch	
		shunt trip	
		undervoltage release	

① Ground-fault sensing and relaying equipment-component (up to 63 A)

② prior to connection of aluminium conductors (≥ 4 mm²) ensure that their contact points are cleaned, brushed and coated with grease

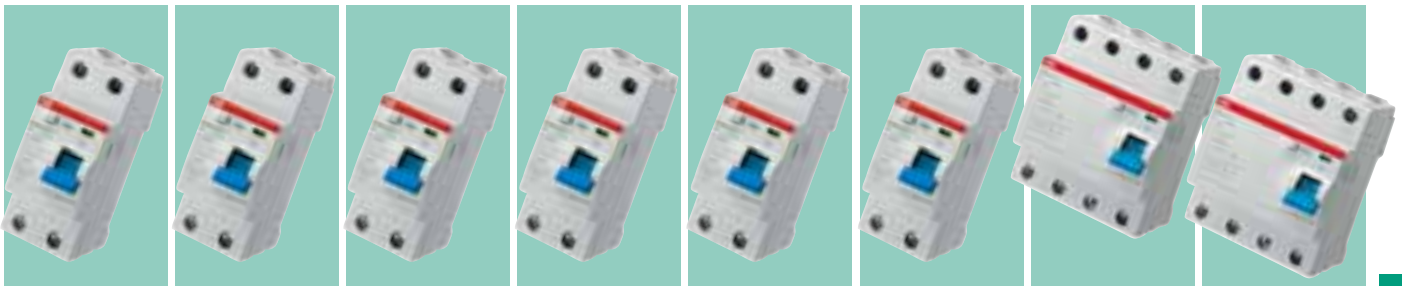

3

F200 AC	F200 A	F200 AC AP-R	F200 A AP-R	F200 AC S	F200 A S	F200 A 400 Hz	F200 A 16 2/3 Hz
IEC/EN 61008, UL 1053 ①						IEC/EN 61008	IEC/EN 61008
AC	A	AC	A	AC	A	A	A
16, 25, 40, 63, 80, 100, 125		2P, 4P (for 125 A only 4P)	2P, 4P (for 125 A only 4P)			4P	2P, 4P
0.01-0.03-0.1-0.3-0.5		25, 40, 63	25, 40, 63, 80, 100, 125	40, 63	40, 63, 80, 100, 125	25, 40	63
		0.03		0.1-0.3-0.5-1		0.03	0.03-0.3-0.5
		230/400 - 240/415					
		480Y/277 (up to 63 A)					-
		500					
		254 (440 for 125 A); 440 for F 200 left neutral				254	254
		277 (up to 63 A); 480 for F 200 left neutral				-	-
		110 (185 for 125 A); 195 for F 200 left neutral				110	110
		50...60				50...400	16 2/3
		10 (for 125 A fuse is gG 125 A)					
		1 (1.25 for 125 A)					
		6					
		2.5					
		III, disconnector abilities					
250		3000		5000		250	250
		blue sealable in ON-OFF position					
		yes					
		10000 (2000 for 125 A)				10000	10000
		20000 (5000 for 125 A)				20000	20000
		IP4X					
		IP2X					
		28 cycles with 55/95...100					
		23/83 - 40/93 - 55/20					
		25/95 - 40/95					
		-25...+55 (-25...+40 for 125 A)				-25...+55	-25...+55
		-35...+70 (up to 63 A)				-	-
		-40...+70					
		failsafe bi-directional cylinder-lift terminal at top and bottom (shock protected) (cage for In > 63 A) ②					
		25/25 (35/35 single slot terminal for In > 63 A)				25/25	25/25
		18-4 (up to 63 A)				-	-
		10/10 (not for In = 80-100 A)				10/10	10/10
		18-8 (up to 63 A)				-	-
		2.8 (3 for In = 125 A)				2.8	2.8
		25 (up to 63 A)				-	-
		Nr. 2 Pozidriv					
		on DIN rail EN 60715 (35 mm) by means of fast clip device					
		from top and bottom					
		it is possible without using any tools only from the bottom (not for 125 A)					
		85 x 69 x 35					
		85 x 69 x 70 (85 x 69.5 x 72 for 125 A)				85 x 69 x 70	85 x 69 x 70
		200					
		350 (380 for In = 80 and 100 A and 460 for In = 125A)				350	350
		yes (no for 125 A)				yes	yes
		yes				yes	yes
		yes (no for 125 A)				yes	yes
		yes (no for 125 A)				yes	yes

AC

F 200 AC type

Function: protection against the effects of sinusoidal alternating earth fault currents; protection against indirect contacts and additional protection against direct (with $I_{\Delta n}=30$ mA) contacts.

Application: residential, commercial, industrial.

Standard: IEC/EN 61008

Marking: according to EN 61008

3



2CSC400565F0201

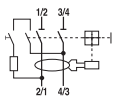

2CSC400569F0201

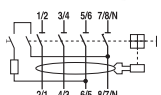

2CSC400197F0201

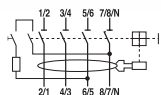

Number of poles	Rated residual current $I_{\Delta n}$ mA	Rated residual current In A	Order details		Bbn 8012542	Price 1 piece	Price group	Weight 1 piece kg	Pack unit pc.
			Type code	Order code					
2	10	16	F202 AC-16/0.01	2CSF202001R0160	779902			0.225	1/6
		25	F202 AC-25/0.03	2CSF202001R1250	780007			0.225	1/6
		40	F202 AC-40/0.03	2CSF202001R1400	780106			0.225	1/6
		63	F202 AC-63/0.03	2CSF202001R1630	780205			0.225	1/6
		80	F202 AC-80/0.03	2CSF202001R1800	914204			0.225	1/6
	30	100	F202 AC-100/0.03	2CSF202001R1900	914303			0.225	1/6
		25	F202 AC-25/0.1	2CSF202001R2250	780304			0.225	1/6
		40	F202 AC-40/0.1	2CSF202001R2400	780403			0.225	1/6
		63	F202 AC-63/0.1	2CSF202001R2630	780502			0.225	1/6
		80	F202 AC-80/0.1	2CSF202001R2800	914402			0.225	1/6
	100	100	F202 AC-100/0.1	2CSF202001R2900	914501			0.225	1/6
		25	F202 AC-25/0.3	2CSF202001R3250	780601			0.225	1/6
		40	F202 AC-40/0.3	2CSF202001R3400	780700			0.225	1/6
		63	F202 AC-63/0.3	2CSF202001R3630	780809			0.225	1/6
		80	F202 AC-80/0.3	2CSF202001R3800	914600			0.225	1/6
300	100	F202 AC-100/0.3	2CSF202001R3900	914709			0.225	1/6	
	25	F202 AC-25/0.5	2CSF202001R4250	780908			0.225	1/6	
	40	F202 AC-40/0.5	2CSF202001R4400	781004			0.225	1/6	
	63	F202 AC-63/0.5	2CSF202001R4630	781103			0.225	1/6	
	80	F202 AC-80/0.5	2CSF202001R4800	914808			0.225	1/6	
4	30	25	F204 AC-25/0.03	2CSF204001R1250	781202			0.375	1/3
		40	F204 AC-40/0.03	2CSF204001R1400	781301			0.375	1/3
		63	F204 AC-63/0.03	2CSF204001R1630	781400			0.375	1/3
		80	F204 AC-80/0.03	2CSF204001R1800	916604			0.405	1/3
		100	F204 AC-100/0.03	2CSF204001R1900	916703			0.405	1/3
	100	125	F204 AC-125/0.03	2CSF204001R1950	941507			0.500	1
		25	F204 AC-25/0.1	2CSF204001R2250	781509			0.375	1/3
		40	F204 AC-40/0.1	2CSF204001R2400	781608			0.375	1/3
		63	F204 AC-63/0.1	2CSF204001R2630	781707			0.375	1/3
		80	F204 AC-80/0.1	2CSF204001R2800	916802			0.405	1/3
	300	100	F204 AC-100/0.1	2CSF204001R2900	916901			0.405	1/3
		125	F204 AC-125/0.1	2CSF204001R2950	941606			0.500	1
		25	F204 AC-25/0.3	2CSF204001R3250	781806			0.375	1/3
		40	F204 AC-40/0.3	2CSF204001R3400	781905			0.375	1/3
		63	F204 AC-63/0.3	2CSF204001R3630	782001			0.375	1/3
500	80	F204 AC-80/0.3	2CSF204001R3800	917007			0.405	1/3	
	100	F204 AC-100/0.3	2CSF204001R3900	917106			0.405	1/3	
	125	F204 AC-125/0.3	2CSF204001R3950	941705			0.500	1	
	25	F204 AC-25/0.5	2CSF204001R4250	782100			0.375	1/3	
	40	F204 AC-40/0.5	2CSF204001R4400	782209			0.375	1/3	
	63	F204 AC-63/0.5	2CSF204001R4630	782308			0.375	1/3	
	80	F204 AC-80/0.5	2CSF204001R4800	917205			0.405	1/3	
	100	F204 AC-100/0.5	2CSF204001R4900	917304			0.405	1/3	
	125	F204 AC-125/0.5	2CSF204001R4950	941804			0.500	1	

AC



2CSC400565F0201

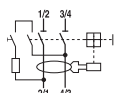

2CSC400569F0201

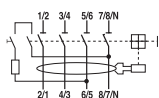

F 200 AC type (for overseas markets)

Function: protection against the effects of sinusoidal alternating earth fault currents; protection against indirect contacts and additional protection against direct (with I Δ n=30 mA) contacts.

Application: residential, commercial, industrial.

Standard: IEC/EN 61008

Marking: according to IEC 61008

Number of poles	Rated residual current I Δ n mA	Rated current In A	Order details		Bbn 8012542 EAN	Price 1 piece	Price group	Weight 1 piece kg	Pack unit pc.	
			Type code	Order code						
2	10	16	F202 AC-16/0.01	2CSF202005R0160	814603			0.225	1/6	
		25	F202 AC-25/0.03	2CSF202005R1250	814702			0.225	1/6	
		40	F202 AC-40/0.03	2CSF202005R1400	814801			0.225	1/6	
		63	F202 AC-63/0.03	2CSF202005R1630	814900			0.225	1/6	
		80	F202 AC-80/0.03	2CSF202005R1800	935902			0.225	1/6	
		100	F202 AC-100/0.03	2CSF202005R1900	936008			0.225	1/6	
	100	25	25	F202 AC-25/0.1	2CSF202005R2250	815006			0.225	1/6
			40	F202 AC-40/0.1	2CSF202005R2400	815105			0.225	1/6
			63	F202 AC-63/0.1	2CSF202005R2630	815204			0.225	1/6
			80	F202 AC-80/0.1	2CSF202005R2800	936107			0.225	1/6
	300	25	25	F202 AC-25/0.3	2CSF202005R3250	815303			0.225	1/6
			40	F202 AC-40/0.3	2CSF202005R3400	815402			0.225	1/6
			63	F202 AC-63/0.3	2CSF202005R3630	815501			0.225	1/6
			80	F202 AC-80/0.3	2CSF202005R3800	936305			0.225	1/6
500	80	80	F202 AC-80/0.5	2CSF202005R4800	936503			0.225	1/6	
		100	F202 AC-100/0.5	2CSF202005R4900	936602			0.225	1/6	

4	30	25	F204 AC-25/0.03	2CSF204005R1250	817109			0.375	1/3	
		40	F204 AC-40/0.03	2CSF204005R1400	817208			0.375	1/3	
		63	F204 AC-63/0.03	2CSF204005R1630	817307			0.375	1/3	
		80	F204 AC-80/0.03	2CSF204005R1800	936701			0.405	1/3	
		100	F204 AC-100/0.03	2CSF204005R1900	936800			0.405	1/3	
		100	25	F204 AC-25/0.1	2CSF204005R2250	817406			0.375	1/3
	100	40	40	F204 AC-40/0.1	2CSF204005R2400	817505			0.375	1/3
			63	F204 AC-63/0.1	2CSF204005R2630	817604			0.375	1/3
			80	F204 AC-80/0.1	2CSF204005R2800	936909			0.405	1/3
			100	F204 AC-100/0.1	2CSF204005R2900	937005			0.405	1/3
	300	25	25	F204 AC-25/0.3	2CSF204005R3250	817703			0.375	1/3
			40	F204 AC-40/0.3	2CSF204005R3400	817802			0.375	1/3
			63	F204 AC-63/0.3	2CSF204005R3630	817901			0.375	1/3
			80	F204 AC-80/0.3	2CSF204005R3800	937104			0.405	1/3
500	80	80	F204 AC-80/0.5	2CSF204005R3900	937203			0.405	1/3	
		100	F204 AC-100/0.5	2CSF204005R4900	937401			0.405	1/3	

A

F 200 A type

Function: protection against the effects of sinusoidal alternating and direct pulsating earth fault currents; protection against indirect contacts and additional protection against direct (with $I_{\Delta n}=30$ mA) contacts.

Application: residential, commercial, industrial.

Standard: IEC/EN 61008

Marking: according to EN 61008

3



2CSC400565F0201

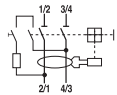

2CSC400569F0201

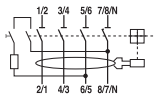

2CSC400197F0201

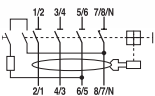

Number of poles	Rated residual current $I_{\Delta n}$ mA	Rated current In A	Order details Type code	Order code	Bbn 8012542 EAN	Price 1 piece	Price group	Weight 1 piece kg	Pack unit pc.		
2	10	16	F202 A-16/0.01	2CSF202101R0160	782407			0.225	1/6		
		30	25	F202 A-25/0.03	2CSF202101R1250	782506		0.225	1/6		
			40	F202 A-40/0.03	2CSF202101R1400	782605		0.225	1/6		
			63	F202 A-63/0.03	2CSF202101R1630	782704		0.225	1/6		
			80	F202 A-80/0.03	2CSF202101R1800	915201		0.225	1/6		
			100	F202 A-100/0.03	2CSF202101R1900	915300		0.225	1/6		
	100	25	40	F202 A-40/0.1	2CSF202101R2400	787006		0.225	1/6		
			63	F202 A-63/0.1	2CSF202101R2630	787105		0.225	1/6		
			80	F202 A-80/0.1	2CSF202101R2800	915409		0.225	1/6		
			100	F202 A-100/0.1	2CSF202101R2900	915508		0.225	1/6		
			300	25	40	F202 A-40/0.3	2CSF202101R3250	782803		0.225	1/6
					63	F202 A-63/0.3	2CSF202101R3630	783008		0.225	1/6
	80	F202 A-80/0.3			2CSF202101R3800	915607		0.225	1/6		
	500	25	100	F202 A-100/0.3	2CSF202101R3900	915706		0.225	1/6		
			40	25	F202 A-25/0.5	2CSF202101R4250	783107		0.225	1/6	
				63	F202 A-63/0.5	2CSF202101R4630	783305		0.225	1/6	
				80	F202 A-80/0.5	2CSF202101R4800	915805		0.225	1/6	
				100	F202 A-100/0.5	2CSF202101R4900	915904		0.225	1/6	
4				30	25	F204 A-25/0.03	2CSF204101R1250	783404		0.375	1/3
	40	F204 A-40/0.03	2CSF204101R1400		783503		0.375	1/3			
	63	F204 A-63/0.03	2CSF204101R1630		783602		0.375	1/3			
	80	F204 A-80/0.03	2CSF204101R1800		917809		0.405	1/3			
	100	F204 A-100/0.03	2CSF204101R1900		917908		0.405	1/3			
	125	F204 A-125/0.03	2CSF204101R1950		941903		0.500	1			
	100	25	40	F204 A-40/0.1	2CSF204101R2400	787303		0.375	1/3		
			63	F204 A-63/0.1	2CSF204101R2630	787402		0.375	1/3		
			80	F204 A-80/0.1	2CSF204101R2800	918004		0.405	1/3		
			100	F204 A-100/0.1	2CSF204101R2900	918103		0.405	1/3		
			125	F204 A-125/0.1	2CSF204101R2950	942009		0.500	1		
			300	25	40	F204 A-40/0.3	2CSF204101R3250	783701		0.375	1/3
	63	F204 A-63/0.3			2CSF204101R3630	783909		0.375	1/3		
	80	F204 A-80/0.3			2CSF204101R3800	918202		0.405	1/3		
	100	F204 A-100/0.3			2CSF204101R3900	918301		0.405	1/3		
	125	F204 A-125/0.3			2CSF204101R3950	942108		0.500	1		
	500	25			40	F204 A-40/0.5	2CSF204101R4250	784005		0.375	1/3
			63	F204 A-63/0.5	2CSF204101R4630	784203		0.375	1/3		
80			F204 A-80/0.5	2CSF204101R4800	918400		0.405	1/3			
100			F204 A-100/0.5	2CSF204101R4900	918509		0.405	1/3			
125			F204 A-125/0.5	2CSF204101R4950	942207		0.500	1			

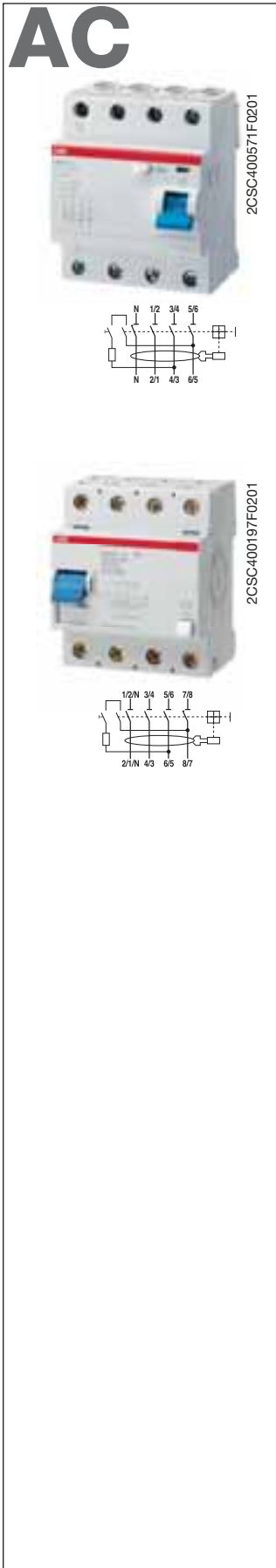

F 200 AC type with neutral pole on the left

Function: protection against the effects of sinusoidal alternating earth fault currents; protection against indirect contacts and additional protection against direct (with $I_{\Delta n}=30$ mA) contacts. Product helpful where for installation habits, for wiring with busbars or cables, for special needs neutral on the left is needed.

Application: residential, commercial, industrial.

Standard: IEC/EN 61008

Marking: according to EN 61008

Number of poles	Rated residual current $I_{\Delta n}$ mA	Rated current I_n A	Order details Type code	Order code	Bbn 8012542 EAN	Price 1 piece	Price group	Weight 1 piece kg	Pack unit pc.	
4	30	25	F204 AC-25/0.03	2CSF204023R1250	815907			0.375	1/3	
		40	F204 AC-40/0.03	2CSF204023R1400	816003			0.375	1/3	
		63	F204 AC-63/0.03	2CSF204023R1630	816102			0.375	1/3	
		80	F204 AC-80/0.03	2CSF204023R1800	917403			0.405	1/3	
		100	F204 AC-100/0.03	2CSF204023R1900	917502			0.405	1/3	
		125	F204 AC-125/0.03	2CSF204023R1950	975106			0.500	1	
	100	25	25	F204 AC-25/0.1	2CSF204023R2250	816201			0.375	1/3
			40	F204 AC-40/0.1	2CSF204023R2400	816300			0.375	1/3
			63	F204 AC-63/0.1	2CSF204023R2630	816409			0.375	1/3
	300	25	25	F204 AC-25/0.3	2CSF204023R3250	816508			0.375	1/3
			40	F204 AC-40/0.3	2CSF204023R3400	816607			0.375	1/3
			63	F204 AC-63/0.3	2CSF204023R3630	816706			0.375	1/3
80			F204 AC-80/0.3	2CSF204023R3800	917601			0.405	1/3	
100			F204 AC-100/0.3	2CSF204023R3900	917700			0.405	1/3	
125			F204 AC-125/0.3	2CSF204023R3950	975304			0.500	1	
500	25	25	F204 AC-25/0.5	2CSF204023R4250	816805			0.375	1/3	
		40	F204 AC-40/0.5	2CSF204023R4400	816904			0.375	1/3	
		63	F204 AC-63/0.5	2CSF204023R4630	817000			0.375	1/3	



A



2CSC400571F0201

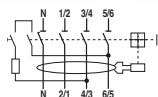

2CSC400197F0201

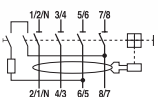

F 200 A type with neutral pole on the left

Function: protection against the effects of sinusoidal alternating and direct pulsating earth fault currents; protection against indirect contacts and additional protection against direct (with $I_{\Delta n}=30$ mA) contacts. Product helpful where for installation habits, for wiring with busbars or cables, for special needs neutral on the left is needed.

Application: residential, commercial, industrial.

Standard: IEC/EN 61008

Marking: according to EN 61008

Number of poles	Rated residual current $I_{\Delta n}$ mA	Rated current In A	Order details Type code	Order code	Bbn 8012542 EAN	Price 1 piece	Price group	Weight 1 piece kg	Pack unit pc.
4	30	25	F204 A-25/0.03	2CSF204123R1250	820109			0.375	1/3
		40	F204 A-40/0.03	2CSF204123R1400	820208		0.375	1/3	
		63	F204 A-63/0.03	2CSF204123R1630	820307		0.375	1/3	
		80	F204 A-80/0.03	2CSF204123R1800	918608		0.405	1/3	
		100	F204 A-100/0.03	2CSF204123R1900	918707		0.405	1/3	
		125	F204 A-125/0.03	2CSF204123R1950	967705		0.500	1	
	100	25	25	F204 A-25/0.1	2CSF204123R2250	820406		0.375	1/3
			40	F204 A-40/0.1	2CSF204123R2400	820505		0.375	1/3
			63	F204 A-63/0.1	2CSF204123R2630	820604		0.375	1/3
	300	25	25	F204 A-25/0.3	2CSF204123R3250	820703		0.375	1/3
			40	F204 A-40/0.3	2CSF204123R3400	820802		0.375	1/3
			63	F204 A-63/0.3	2CSF204123R3630	820901		0.375	1/3
80			F204 A-80/0.3	2CSF204123R3800	918806		0.405	1/3	
100			F204 A-100/0.3	2CSF204123R3900	918905		0.405	1/3	
125			F204 A-125/0.3	2CSF204123R3950	967804		0.500	1	
500	25	25	F204 A-25/0.5	2CSF204123R4250	821007		0.375	1/3	
		40	F204 A-40/0.5	2CSF204123R4400	821106		0.375	1/3	
		63	F204 A-63/0.5	2CSF204123R4630	821205		0.375	1/3	

AC



2CSC400565F0201

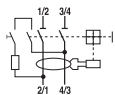

2CSC400569F0201

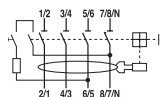

F 200 AP-R, AC type

Function: protection against the effects of sinusoidal alternating earth fault currents, providing the best compromise between safety and continuity in the service thanks to the resistance to unwanted trippings; protection against indirect contacts and additional protection against direct ($I\Delta n=30$ mA) contacts.

Application: residential, commercial, industrial.

Standard: IEC/EN 61008

Surge current resistance (wave 8/20)=3000 A

Marking: according to EN 61008

Number of poles	Rated residual current $I\Delta n$ mA	Rated current I_n A	Order details		Bbn	Price	Price	Weight	Pack
			Type code	Order code	8012542	1 piece	group	1 piece	unit
					EAN			kg	pc.
2	30	25	F202 AC-25/0.03 AP-R	2CSF202301R1250	785705			0.225	1/6
		40	F202 AC-40/0.03 AP-R	2CSF202301R1400	823704			0.225	1/6
		63	F202 AC-63/0.03 AP-R	2CSF202301R1630	785804			0.225	1/6

4	30	25	F204 AC-25/0.03 AP-R	2CSF204301R1250	785903			0.375	1/3
		40	F204 AC-40/0.03 AP-R	2CSF204301R1400	823803			0.375	1/3
		63	F204 AC-63/0.03 AP-R	2CSF204301R1630	786009			0.375	1/3

A

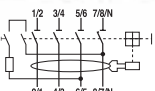
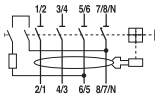
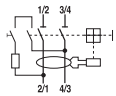

F 200 AP-R, A type

Function: protection against the effects of sinusoidal alternating and direct pulsating earth fault currents, providing the best compromise between safety and continuity in the service thanks to the resistance to unwanted trippings; protection against indirect contacts and additional protection against direct ($I_{\Delta n}=30$ mA) contacts.

Application: residential, commercial, industrial.

Standard: IEC/EN 61008

Surge current resistance (wave 8/20)=3000 A

Marking: according to EN 61008

Number of poles	Rated residual current $I_{\Delta n}$ mA	Rated current In A	Order details	Bbn 8012542	Price 1 piece	Price group	Weight 1 piece kg	Pack unit pc.
			Type code	Order code	EAN			
2	30	25	F202 A-25/0.03 AP-R	2CSF202401R1250	785101		0.225	1/6
		40	F202 A-40/0.03 AP-R	2CSF202401R1400	785200		0.225	1/6
		63	F202 A-63/0.03 AP-R	2CSF202401R1630	785309		0.225	1/6
		80	F202 A-80/0.03 AP-R	2CSF202401R1800	916406		0.225	1/6
		100	F202 A-100/0.03 AP-R	2CSF202401R1900	916505		0.225	1/6

4	30	25	F204 A-25/0.03 AP-R	2CSF204401R1250	785408		0.375	1/3
		40	F204 A-40/0.03 AP-R	2CSF204401R1400	785507		0.375	1/3
		63	F204 A-63/0.03 AP-R	2CSF204401R1630	785606		0.375	1/3
		80	F204 A-80/0.03 AP-R	2CSF204401R1800	919407		0.405	1/3
		100	F204 A-100/0.03 AP-R	2CSF204401R1900	919506		0.405	1/3
		125	F204 A-125/0.03 AP-R	2CSF204401R1950	967903		0.500	1

AC



2CSC400565F0201

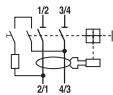

2CSC400569F0201

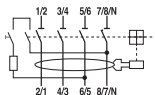

F 200 AC selective type

Function: protection against the effects of sinusoidal alternating earth fault currents with an intentional tripping delay, which permits to realize the selectivity with downstream instantaneous devices (for more information about selectivity see the technical guide); protection against indirect contacts.

Application: commercial, industrial.

Standard: IEC/EN 61008

Surge current resistance (wave 8/20)=5000 A

Marking: according to EN 61008

Number of poles	Rated residual current I Δ n mA	Rated current In A	Order details		Bbn 8012542	Price 1 piece	Price group	Weight 1 piece kg	Pack unit pc.
			Type code	Order code					
2	100	40	F202 AC S-40/0.1	2CSF202901R2400	821304			0.225	1/6
		63	F202 AC S-63/0.1	2CSF202901R2630	821403			0.225	1/6
	300	40	F202 AC S-40/0.3	2CSF202901R3400	821502			0.225	1/6
		63	F202 AC S-63/0.3	2CSF202901R3630	821601			0.225	1/6
	500	40	F202 AC S-40/0.5	2CSF202901R4400	821700			0.225	1/6
		63	F202 AC S-63/0.5	2CSF202901R4630	821809			0.225	1/6
1000	40	F202 AC S-40/1	2CSF202901R5400	821908			0.225	1/6	
	63	F202 AC S-63/1	2CSF202901R5630	822004			0.225	1/6	

4	100	40	F204 AC S-40/0.1	2CSF204901R2400	822103			0.375	1/3
		63	F204 AC S-63/0.1	2CSF204901R2630	822202			0.375	1/3
	300	40	F204 AC S-40/0.3	2CSF204901R3400	822301			0.375	1/3
		63	F204 AC S-63/0.3	2CSF204901R3630	822400			0.375	1/3
	500	40	F204 AC S-40/0.5	2CSF204901R4400	822509			0.375	1/3
		63	F204 AC S-63/0.5	2CSF204901R4630	822608			0.375	1/3
1000	40	F204 AC S-40/1	2CSF204901R5400	822707			0.375	1/3	
	63	F204 AC S-63/1	2CSF204901R5630	822806			0.375	1/3	

A

F 200 A selective type

Function: protection against the effects of sinusoidal alternating and direct pulsating earth fault currents with an intentional tripping delay, which permits to realize the selectivity with downstream instantaneous devices (for more information about selectivity see the technical guide); protection against indirect contacts.

Application: commercial, industrial.

Standard: IEC/EN 61008

Surge current resistance (wave 8/20)=5000 A

Marking: according to EN 61008

3



2CSC400565F0201

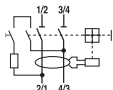

2CSC400569F0201

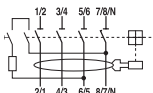

2CSC400197F0201

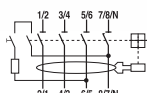

Number of poles	Rated residual current I Δ n mA	Rated current In A	Order details Type code	Order code	Bbn 8012542 EAN	Price 1 piece	Price group	Weight 1 piece kg	Pack unit pc.
2	100	40	F202 A S-40/0.1	2CSF202201R2400	822905			0.225	1/6
		63	F202 A S-63/0.1	2CSF202201R2630	823001			0.225	1/6
		100	F202 A S-100/0.1	2CSF202201R2900	916000			0.225	1/6
	300	40	F202 A S-40/0.3	2CSF202201R3400	784302			0.225	1/6
		63	F202 A S-63/0.3	2CSF202201R3630	784401			0.225	1/6
		100	F202 A S-100/0.3	2CSF202201R3900	916109			0.225	1/6
	500	40	F202 A S-40/0.5	2CSF202201R4400	784500			0.225	1/6
		63	F202 A S-63/0.5	2CSF202201R4630	784609			0.225	1/6
		100	F202 A S-100/0.5	2CSF202201R4900	916208			0.225	1/6
1000	40	F202 A S-40/1	2CSF202201R5400	823100			0.225	1/6	
	63	F202 A S-63/1	2CSF202201R5630	823209			0.225	1/6	
	100	F202 A S-100/1	2CSF202201R5900	916307			0.225	1/6	

4	100	40	F204 A S-40/0.1	2CSF204201R2400	823308			0.375	1/3
		63	F204 A S-63/0.1	2CSF204201R2630	823407			0.375	1/3
		100	F204 A S-100/0.1	2CSF204201R2900	919001			0.405	1/3
	300	40	F204 A S-40/0.3	2CSF204201R3400	784708			0.375	1/3
		63	F204 A S-63/0.3	2CSF204201R3630	784807			0.375	1/3
		100	F204 A S-100/0.3	2CSF204201R3900	919100			0.405	1/3
	500	125	F204 A S-125/0.3	2CSF204201R3950	968207			0.500	1
		40	F204 A S-40/0.5	2CSF204201R4400	784906			0.375	1/3
		63	F204 A S-63/0.5	2CSF204201R4630	785002			0.375	1/3
	1000	100	F204 A S-100/0.5	2CSF204201R4900	919209			0.405	1/3
		125	F204 A S-125/0.5	2CSF204201R4950	968405			0.500	1
		40	F204 A S-40/1	2CSF204201R5400	823506			0.375	1/3
	63		F204 A S-63/1	2CSF204201R5630	823605			0.375	1/3
		100	F204 A S-100/1	2CSF204201R5900	919308			0.405	1/3



F 200 A type for high frequency (400 Hz)

Function: protection against the effects of sinusoidal alternating and direct pulsating earth fault currents; protection against indirect contacts and additional protection against direct (with $I_{\Delta n}=30$ mA) contacts.

Advantages: increasing the frequency generates an increase of the magnetic reluctance of the toroidal transformer of standard RCCB and what follows is the value of the increasing operating residual current at 400 Hz reaching values 3 or more times higher than those of the residual current at 50Hz. The RCCB F 200 400 Hz guarantees protection against indirect contacts and additional protection against direct (with $I_{\Delta n}=30$ mA) contacts considering that the operating residual current doesn't increase with the increase of the network frequency.

Application: commercial, industrial.

Standard: IEC/EN 61008

Marking: according to EN 61008

Number of poles	Rated residual current $I_{\Delta n}$ mA	Rated current I_n A	Order details		Bbn 8012542	Price 1 piece	Price group	Weight 1 piece kg	Pack unit pc.
			Type code	Order code					
4	30	25	F204 A-25/0.03 400Hz	2CSF204197R1250	968603			0.375	1/3
		40	F204 A-40/0.03 400Hz	2CSF204197R1400					



F200 A type 16 2/3 Hz

Function: protection against the effects of sinusoidal alternating and direct pulsating earth fault currents; protection against indirect contacts and additional protection against direct (with $I_{\Delta n}=30$ mA) contacts.

The RCCB F200 16 2/3 Hz can work at rated frequency of 16 2/3 Hz which is common in railways applications

Application: railways

Standard: IEC/ EN 61008

Marking: according to EN 61008

Number of poles	Rated residual current $I_{\Delta n}$ mA	Rated current I_n A	Order details		Bbn 8012542	Price 1 piece	Price group	Weight 1 piece kg	Pack unit pc.	
			Type code	Order code						EAN
2	30	63	F202 A-63/0.03 16-2/3Hz	2CSF202196R1630	734536			0.225	1/6	
		300	F202 A-63/0.3 16-2/3Hz	2CSF202196R3630						733638
		500	F202 A-63/0.5 16-2/3Hz	2CSF202196R4630						734437
4	30	63	F204 A-63/0.03 16-2/3Hz	2CSF204196R1630	733539			0.375	1/3	
		300	F204 A-63/0.3 16-2/3Hz	2CSF204196R3630						734338
		500	F204 A-63/0.5 16-2/3Hz	2CSF204196R4630						733430

3

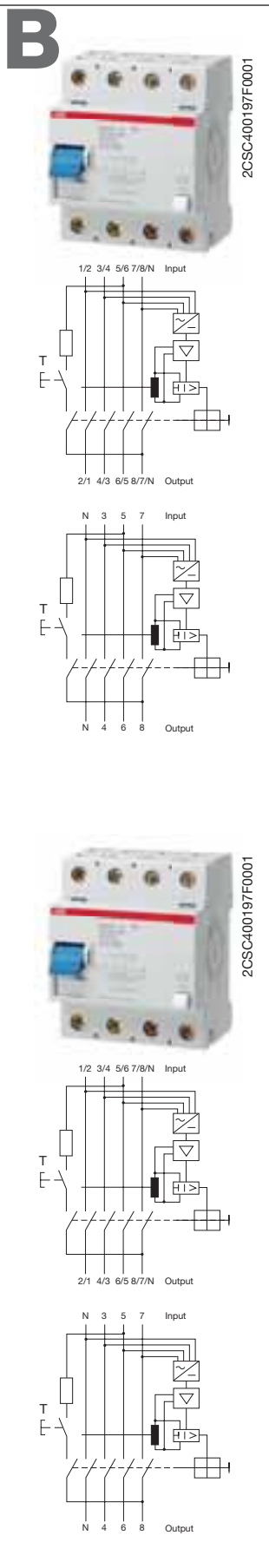

F 200 B type for smooth DC earth fault current

Function: protection against the effects of sinusoidal alternating, direct pulsating and pulsating DC or smooth DC earth fault currents; protection against indirect contacts and additional protection against direct (with $I_{\Delta n}=30$ mA) contacts.

Application: industrial.

Standard: IEC/EN 61008, IEC 62423

Marking: according to EN 61008

Number of poles	Rated residual current $I_{\Delta n}$ mA	Rated current I_n A	Order details		Bbn 8012542	Price 1 piece	Price group	Weight 1 piece	Pack unit	
			Type code	Order code						
4	30	40	F204 B-40/0.03	2CSF204501R1400	988403			0.500	1	
		63	F204 B-63/0.03	2CSF204501R1630						988502
		125 ①	F204 B-125/0.03	2CSF204523R1950						
	300	63	F204 B-63/0.3	2CSF204501R3630	989004					
		125 ①	F204 B-125/0.3	2CSF204523R3950		989202				
		500	125 ①	F204 B-125/0.5			2CSF204523R4950	730439		

① Devices with rated current $I_n=125$ A are with neutral on the left

F 200 B selective type for smooth DC earth fault current

Function: protection against the effects of sinusoidal alternating, direct pulsating and pulsating DC or smooth DC earth fault currents with an intentional tripping delay, which permits to realize the selectivity with downstream instantaneous devices (for more information about selectivity see the technical guide); protection against indirect contacts.

Application: industrial.

Standard: IEC/EN 61008, IEC 62423

Surge current resistance (wave 8/20)=5000 A

Marking: according to EN 61008

Number of poles	Rated residual current $I_{\Delta n}$ mA	Rated current I_n A	Order details		Bbn 8012542	Price 1 piece	Price group	Weight 1 piece	Pack unit	
			Type code	Order code						
4	300	63	F204 B S-63/0.3	2CSF204801R3630	989301			0.500	1	
		125 ①	F204 B S-125/0.3	2CSF204823R3950						989509
		500	125 ①	F204 B S-125/0.5						

① Devices with rated current $I_n=125$ A are with neutral on the left

Type (wave form of the detected dispersion current)	B		
Rated current I _n	[A]	40	63 125
No. of poles			4
Rated voltage U _n	[V]		230/400
Working range of test circuit	[V]		185 V AC-440 V AC
Rated conditional short-circuit current I _{nc}	[kA]		10
Rated conditional residual short-circuit current I _{Δc}	[kA]		10
Rated making and breaking capacity I _m	[A]	500	800 1250
Rated residual making and breaking capacity I _{Δm}	[A]	500	800 1250
Surge current resistance		ring wave 0,5 ms/100 kHz: 200 A, impulse 8/20 μs: 3 kA (impulse 8/20 μs: 5 kA for F200 type B S - selective)	
Rated sensitivity I _{Δn}	[A]	0.03	0.03-0.3 0.03-0.3-0.5
Working frequency range	[Hz]		0-1000
Min. operating voltage for detecting type A/AC residual currents	[V]		0 V
for detecting type B residual currents	[V]		30 V a.c.
Own consumption	[W]		max. 3.5
Dissipated power P _v	[W]	2.9	7.2 28
Short-circuit fuse acc. to VDE 0636/IEC 60269-1		80 A/gL	100 A/gG 125 A/gL
Tripping time F200 type B	[ms]		1 x I _{Δn} ≤ 300 ms; 5 x I _{Δn} ≤ 40 ms
Tripping time F200 type B S	[ms]		1 x I _{Δn} > 130 ms ≤ 500 ms; 5 x I _{Δn} > 50 ms ≤ 150 ms
Toggle			Blue sealable in ON/OFF position
Impact resistance			20 g/20 ms
Protection degree			IP40 (after installation in distribution board)
Supply			terminal 1, 3, 5, 7
Ambient temperature	[°C]		-25...+40
Resistance to climate changes acc. to IEC 68-2-30			25 °C/55 °C; 93%/97% relative humidity, 28 cycles
Cables max. size	[mm ²]		1x1.5-50 mm ² ; 2x1.5-16 mm ²
Terminal size	[mm ²]		50
Tightening torque	[N*m]		3
Mechanical life			> 5000
Electrical life			> 2000
Electromagnetic compatibility			IEC 61453; DIN VDE 0664 Pt.30
Mounting			on DIN rail EN 60715 (35 mm) by means of fast clip device
Dimensions (H x P x L)	[mm]		85 x 69,5 x 70
Weight 4P	[g]		500

B



2CSF400676F0001

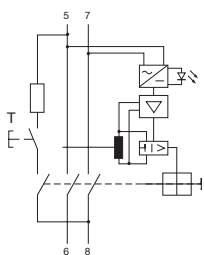

F200 PV B type for smooth DC earth fault current for photovoltaic applications

Function: protection against the effects of sinusoidal alternating, direct pulsating and pulsating DC or smooth DC earth fault currents; protection against indirect contacts and additional protection against direct (with $I_{\Delta n}=30\text{mA}$) contacts.

Where an electrical installation includes a PV power supply system without at least simple separation between the AC side and the DC side, an RCD installed to provide fault protection by automatic disconnection of supply should be type B according to IEC 60755, amendment 2 (according to IEC 60364-7 art. 712.413.1.1.1.2)

Application: particularly suitable for use in solar energy (photovoltaic) systems

standard: IEC/EN 61008, IEC 62423

Marking: according to EN 61008

Number of poles	Rated residual current $I_{\Delta n}$ mA	Rated current I_n A	Order details		Bbn	Price	Price group	Weight	Pack unit
			Type code	Order code	8012542	1 piece	1 piece	kg	pc.
2	30	25	F202PV B-25/0,03	2CSF202601R1250	071235			0.500	1
		63	F202PV B-63/0,03	2CSF202601R1630	368632			0.500	1
	300	25	F202PV B-25/0,3	2CSF202601R3250	910831			0.500	1
		63	F202PV B-63/0,3	2CSF202601R3630	659037			0.500	1

3

Rated current I_n	25A	63 A
Rated sensitivity IΔ_n	0.03 - 0.3 A	
Working frequency range	0 - 1000 Hz	
Rated voltage U_n	230 V AC	
Rated frequency	50 Hz	
Min. operating voltage for detecting type A/AC residual currents	0 V (mains voltage-independent)	
for detecting type B residual currents	30 V AC	
Own consumption	max. 1.2 W	
Working range of test circuit	100 V AC – 250 V AC	
No. of poles:	2-pole	
Dissipated power P_v	1.2 W	7.2 W
Short-circuit fuse to VDE 0636 / IEC 60269-1	100 A/gG	
Tripping times F200PV B type	1xI Δ _n ≤ 300 ms; 5xI Δ _n ≤ 40 ms	
Rated making and breaking capacity I_m	500 A	800 A
Rated residual making and breaking capacity IΔ_m	500 A	800 A
Rated short circuit current I_{nc}	10 kA	
Rated conditional residual short-circuit current IΔ_c	10 kA	
Surge current resistance	Ring wave 0.5 ms / 100 kHz: 200 A, impulse 8/20 μ s: 3 kA	
Impact resistance	20 g / 20 ms duration	
Enclosure protection type	IP40 (after installation in distribution board)	
Input side	Terminals 5, 7	
Ambient temperature	-25°C to 40°C	
Resistance to climate changes according to IEC 68-2-30	damp / heat cyclic (25°C / 55°C; 93% / 97% rel.hum., 28 cycles)	
Cables max. size	1x1.5-50 mm ² (1-wire connect.); 2x1.5-16 mm ² (2-wire connect.)	
Tightening torque of fastening screws	3 Nm	
Mechanical life	> 5000 switching cycles	
Electrical life	> 2000 switching cycles	
Electromagnetic compatibility	IEC 61453; DIN VDE 0664 Pt.30 (interference resistance-industrial environment)	
Mounting	On DIN rail EN 60715 (35 mm) by means of fast clip device; any mounting position	
Toggle	Blue sealable in ON/OFF position.	
Dimensions (H x D x W)	85 x 69 x 72 mm	
Weight	500 g	

3

TECHNICAL FEATURES

Standards

Operating characteristic: type

Rated current I_n [A]

Poles

Rated voltage U_e 2P [V]
 3P
 4P

Insulation voltage U_i [V]

Operating voltage of circuit test U_t 2P [V]
 3P
 4P

Rated frequency Hz

Rated breaking capacity according to IEC EN 61009 [A]

Rated breaking capacity according to IEC EN 60947-2 [A]

Rated residual breaking capacity I_{Δm} [kA]

Rated impulse withstand capacity (1,2/50) U_{imp} [kV]

Dielectric test voltage at ind. freq. for 1 min. [kV]

Surge current resistance (wave 8/20) [A]

Rated sensitivity I_{Δn} [A]

Toggle

Electrical life

Mechanical life

Protection degree housing terminals

Tropicalization humid heat [°C/RH]

according to DIN 40046 IEC 68-2 constant climatic conditions [°C/RH]

variable climatic conditions [°C/RH]

Ambient temperature (with daily average ≤ +35 °C) [°C]

Storage temperature [°C]

Terminal type 2P
 3P/4P I_n=25 and 40 A
 3P/4P I_n=63 A

Terminal size 2P [mm²]
 3P/4P I_n=25 and 40 A [mm²]
 3P/4P I_n=63 A [mm²]

Tightening torque 2P [N*m]
 3P/4P I_n=25 and 40 A [N*m]
 3P/4P I_n=63 A [N*m]

Mounting

Dimensions 2P [mm]

H x P x L 3P/4P I_n=25 and 40 A [mm]

3P/4P I_n=63 A [mm]

Weight 2P [g]

3P/4P I_n=25 and 40 A [g]

3P/4P I_n=63 A [g]

Combinable with S 200 L
 S 200
 S 200 M
 S 200 P

① All RCD-blocks DDA 200 with rated current 63 A are provided with two additional terminals for remote tripping.

② DDA200 A AE is provided with two additional terminals for remote release in positive safety.

A remote control circuit should be connected to those terminals where circuit breakers or push buttons with normally closed contacts should be inserted.

System **pro M compact®** Technical features RCD-blocks DDA 200 series

DDA 200



3

DDA 200 AC	DDA 200 A	DDA 200 AC AP-R	DDA 200 A AP-R	DDA 200 A AE	DDA 200 AC S	DDA 200 A S	DDA 200 B
IEC EN 61009 App.G							IEC EN 61009 App. G and IEC 60755
AC	A	AC	A	A	AC	A	B
25, 40, 63 ①		25, 40, 63 ①	2P, 3P, 4P	63 ②	63 ①		63
		230 (400 for special execution @400 V) 230/400 230/400		230 400 230	230 230/400 230/400		3P, 4P
			500				230
		110-254 (400 for special execution @400 V) 195-440 (110-254 for special execution @110 V) 195-440 (110-254 for special execution @110 V)		184-264 310-440 184-264	110-254 195-440 195-440		310-440 195-254
			50...60				
			same of the coupled MCB				
			same of the coupled MCB				
			same of the coupled MCB				
			4				
			2,5				
250		3000		250	5000		3000 (5000 for selective types)
0.01-0.03-0.1-0.3-0.5-1		0.03		0.03-0.3-0.5-1	0.1-0.3-0.5-1		0.03 - 0.3
			blue				
			10000				
			20000				
			IP4X				
			IP2X				
			28 cycles with 55/95...100				
			23/83 - 40/93 - 55/20				
			25/95 - 40/95				
			-25...+55				
			-40...+70				
			bi-directional cylinder-lift cage type				
			bi-directional cylinder-lift (rigid or flexible) up to 25				
			(rigid or flexible) up to 16				
			(rigid or flexible) up to 25				
			2.8				
			1.2				
			2.8				
			on DIN rail EN 60715 (35 mm) by means of fast clip device				
			85 x 69 x 35				
			85 x 69 x 35				
			85 x 69 x 70				
			175				
			175				
			325				
			yes				
			yes				
			yes				
			yes				

AC



2CSC400163F0201

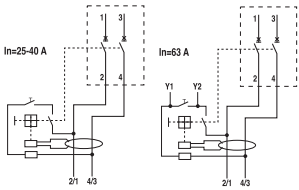

2CSC400164F0201

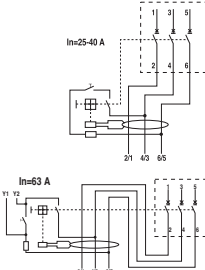

2CSC400165F0201

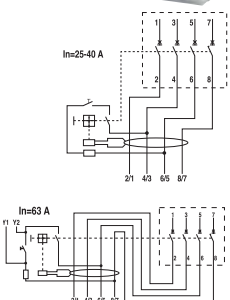

DDA 200 AC type

Function: RCD-block for assembly on site with MCBs S 200 series. Protection against the effects of sinusoidal alternating earth fault currents; protection against indirect contacts and additional protection against direct (with $I_{\Delta n}=30$ mA) contacts.

Application: residential, commercial, industrial.

Standard: IEC/EN 61009 Ann. G

Number of poles	Rated residual current $I_{\Delta n}$ mA	Rated current In A	Order details	Bbn 8012542	Price 1 piece	Price group	Weight 1 piece kg	Pack unit pc.
			Type code	Order code				
					EAN			
2	10	25	DDA202 AC-25/0.01	2CSB202001R0250	791003		0.180	1
		30	DDA202 AC-25/0.03	2CSB202001R1250	791102		0.180	1
		40	DDA202 AC-40/0.03	2CSB202001R1400	791201		0.180	1
	63 ②	25	DDA202 AC-63/0.03	2CSB202001R1630	791300		0.180	1
		40	DDA202 AC-40/0.1	2CSB202001R2400	791508		0.180	1
		63 ②	DDA202 AC-63/0.1	2CSB202001R2630	791607		0.180	1
	100	25	DDA202 AC-25/0.1	2CSB202001R2250	791409		0.180	1
		40	DDA202 AC-40/0.3	2CSB202001R3400	791805		0.180	1
		63 ②	DDA202 AC-63/0.3	2CSB202001R3630	791904		0.180	1
	300	25	DDA202 AC-25/0.3	2CSB202001R3250	791706		0.180	1
		40	DDA202 AC-40/0.5	2CSB202001R4400	792000		0.180	1
		63 ②	DDA202 AC-63/0.5	2CSB202001R4630	792208		0.180	1
500	25	DDA202 AC-25/1	2CSB202001R5250	808305		0.180	1	
	40	DDA202 AC-40/1	2CSB202001R5400	808404		0.180	1	
	63 ②	DDA202 AC-63/1	2CSB202001R5630	792307		0.180	1	
2000	63	DDA202 AC-63/2	2CSB202001R6630	792406		0.180	1	
	30	25	DDA203 AC-25/0.03	2CSB203001R1250	792505		0.220	1
		40	DDA203 AC-40/0.03	2CSB203001R1400	792604		0.220	1
63 ②		DDA203 AC-63/0.03	2CSB203001R1630	792703		0.260	1	
100	25	DDA203 AC-25/0.1	2CSB203001R2250	792802		0.220	1	
	40	DDA203 AC-40/0.1	2CSB203001R2400	792901		0.220	1	
	63 ②	DDA203 AC-63/0.1	2CSB203001R2630	793007		0.260	1	
300	25	DDA203 AC-25/0.3	2CSB203001R3250	793106		0.220	1	
	40	DDA203 AC-40/0.3	2CSB203001R3400	793205		0.220	1	
	63 ②	DDA203 AC-63/0.3	2CSB203001R3630	793304		0.260	1	
500	25	DDA203 AC-25/0.5	2CSB203001R4250	793403		0.220	1	
	40	DDA203 AC-40/0.5	2CSB203001R4400	793502		0.220	1	
	63 ②	DDA203 AC-63/0.5	2CSB203001R4630	793601		0.260	1	
1000	25	DDA203 AC-25/1	2CSB203001R5250	808503		0.220	1	
	40	DDA203 AC-40/1	2CSB203001R5400	808602		0.220	1	
	63 ②	DDA203 AC-63/1	2CSB203001R5630	793700		0.260	1	
2000	63	DDA203 AC-63/2	2CSB203001R6630	793809		0.260	1	
	30	25	DDA204 AC-25/0.03	2CSB204001R1250	793908		0.260	1
		40	DDA204 AC-40/0.03	2CSB204001R1400	794004		0.260	1
63 ① ②		DDA204 AC-63/0.03	2CSB204001R1630	794103		0.305	1	
100	25	DDA204 AC-25/0.1	2CSB204001R2250	794202		0.260	1	
	40	DDA204 AC-40/0.1	2CSB204001R2400	794301		0.260	1	
	63 ②	DDA204 AC-63/0.1	2CSB204001R2630	794400		0.305	1	
300	25	DDA204 AC-25/0.3	2CSB204001R3250	794509		0.260	1	
	40	DDA204 AC-40/0.3	2CSB204001R3400	794608		0.260	1	
	63 ②	DDA204 AC-63/0.3	2CSB204001R3630	794707		0.305	1	
500	25	DDA204 AC-25/0.5	2CSB204001R4250	794806		0.260	1	
	40	DDA204 AC-40/0.5	2CSB204001R4400	794905		0.260	1	
	63 ②	DDA204 AC-63/0.5	2CSB204001R4630	795001		0.305	1	
1000	25	DDA204 AC-25/1	2CSB204001R5250	808701		0.260	1	
	40	DDA204 AC-40/1	2CSB204001R5400	808800		0.260	1	
	63 ②	DDA204 AC-63/1	2CSB204001R5630	795100		0.305	1	
2000	63	DDA204 AC-63/2	2CSB204001R6630	795209		0.305	1	

① version with test button working at 110VAC - 254VAC is available. For selection tables refer to special version paragraph.
② provided with additional terminals for remote tripping

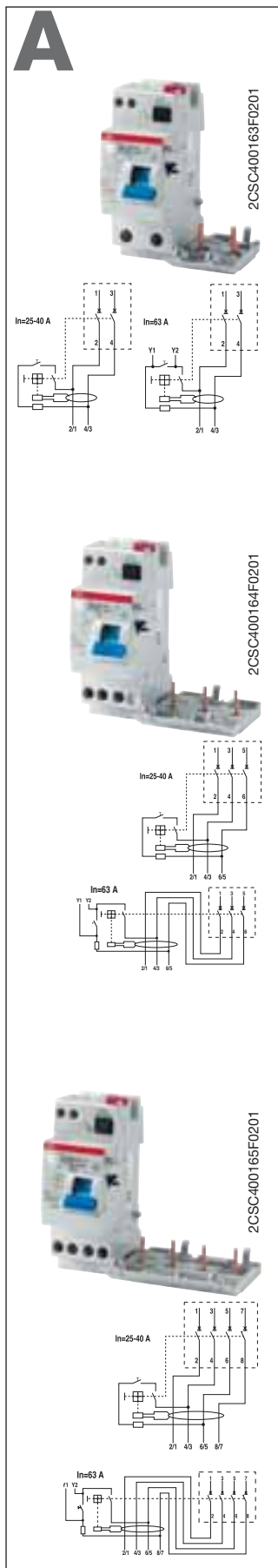

DDA 200 A type

Function: RCD-block for assembly on site with MCBs S 200 series. Protection against the effects of sinusoidal alternating and direct pulsating earth fault currents; protection against indirect contacts and additional protection against direct (with $I_{\Delta n}=30$ mA) contacts.

Application: residential, commercial, industrial.

Standard: IEC/EN 61009 Ann. G

Number of poles	Rated residual current $I_{\Delta n}$ mA	Rated current I_n A	Order details		Bbn 8012542	Price 1 piece	Price group	Weight 1 piece kg	Pack unit pc.
			Type code	Order code					
2	10	25	DDA202 A-25/0.01	2CSB202101R0250	795308			0.180	1
			DDA202 A-25/0.03	2CSB202101R1250	795407			0.180	1
			DDA202 A-40/0.03	2CSB202101R1400	795506			0.180	1
	30	25	DDA202 A-25/0.1	2CSB202101R2250	795704			0.180	1
			DDA202 A-40/0.1	2CSB202101R2400	795803			0.180	1
			DDA202 A-63/0.1	2CSB202101R2630	795902			0.180	1
	100	25	DDA202 A-25/0.3	2CSB202101R3250	796008			0.180	1
			DDA202 A-40/0.3	2CSB202101R3400	796107			0.180	1
			DDA202 A-63/0.3	2CSB202101R3630	796206			0.180	1
	300	25	DDA202 A-25/0.5	2CSB202101R4250	796305			0.180	1
			DDA202 A-40/0.5	2CSB202101R4400	796404			0.180	1
			DDA202 A-63/0.5	2CSB202101R4630	796503			0.180	1
500	25	DDA202 A-25/1	2CSB202101R5250	808909			0.180	1	
		DDA202 A-40/1	2CSB202101R5400	809005			0.180	1	
		DDA202 A-63/1	2CSB202101R5630	796602			0.180	1	
3	30	25	DDA203 A-25/0.03	2CSB203101R1250	796701			0.220	1
			DDA203 A-40/0.03	2CSB203101R1400	796800			0.220	1
			DDA203 A-63/0.03	2CSB203101R1630	796909			0.260	1
	100	25	DDA203 A-25/0.1	2CSB203101R2250	797005			0.220	1
			DDA203 A-40/0.1	2CSB203101R2400	797104			0.220	1
			DDA203 A-63/0.1	2CSB203101R2630	797203			0.260	1
	300	25	DDA203 A-25/0.3	2CSB203101R3250	797302			0.220	1
			DDA203 A-40/0.3	2CSB203101R3400	797401			0.220	1
			DDA203 A-63/0.3	2CSB203101R3630	797500			0.260	1
	500	25	DDA203 A-25/0.5	2CSB203101R4250	797609			0.220	1
			DDA203 A-40/0.5	2CSB203101R4400	797708			0.220	1
			DDA203 A-63/0.5	2CSB203101R4630	797807			0.260	1
1000	25	DDA203 A-25/1	2CSB203101R5250	809104			0.220	1	
		DDA203 A-40/1	2CSB203101R5400	809203			0.220	1	
		DDA203 A-63/1	2CSB203101R5630	797906			0.260	1	
4	30	25	DDA204 A-25/0.03	2CSB204101R1250	798002			0.260	1
			DDA204 A-40/0.03	2CSB204101R1400	798101			0.260	1
			DDA204 A-63/0.03	2CSB204101R1630	798200			0.305	1
	100	25	DDA204 A-25/0.1	2CSB204101R2250	798309			0.260	1
			DDA204 A-40/0.1	2CSB204101R2400	798408			0.260	1
			DDA204 A-63/0.1	2CSB204101R2630	798507			0.305	1
	300	25	DDA204 A-25/0.3	2CSB204101R3250	798606			0.260	1
			DDA204 A-40/0.3	2CSB204101R3400	798705			0.260	1
			DDA204 A-63/0.3	2CSB204101R3630	798804			0.305	1
	500	25	DDA204 A-25/0.5	2CSB204101R4250	798903			0.260	1
			DDA204 A-40/0.5	2CSB204101R4400	799009			0.260	1
			DDA204 A-63/0.5	2CSB204101R4630	799108			0.305	1
1000	25	DDA204 A-25/1	2CSB204101R5250	809302			0.260	1	
		DDA204 A-40/1	2CSB204101R5400	809401			0.260	1	
		DDA204 A-63/1	2CSB204101R5630	799207			0.305	1	

① version with test button working at 110VAC - 254VAC is available. For selection tables refer to special version paragraph.
② provided with additional terminals for remote tripping

DDA 200 special version 110 V and 400 V

Function: special version of RCD-blocks to assembly on site with MCBs S 200 series. Special version are available with protection against the effects of sinusoidal alternating and/or direct pulsating earth fault currents, protection against indirect contacts and additional protection against direct contacts (with $I_{\Delta n}=30$ mA).

DDA200 110 V is a particular RCD-block with voltage range for test button $U_t = 110-245$ V. RCD-blocks work for naval applications where the IT system is typically used and the voltage between the phase and the neutral conductor is 115 - 125 V. DDA200 110 V ($U_t = 110-245$ V) are suitable for naval applications.

Special version is also available for 400 V in the two poles version working in two-phase industrial systems where voltage between phases is 400 V.

Applications: naval, industrial.

Standards: IEC EN 61009 Ann. G

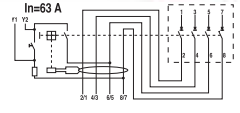
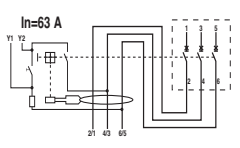
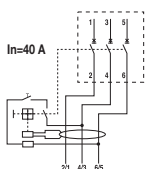
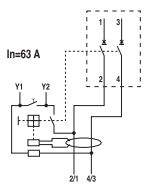

110 V version

Number of poles	Rated residual current	Rated current	Order details	Bbn	Price	Price group	Weight	Pack unit
$I_{\Delta n}$ mA	In A	Type code	Order code	EAN	1 piece		1 piece	pc.

AC type

4	AC	63 ①	DDA 204 AC-63/0.03 110V	2CSB204099R1630	929901		0.350	1
---	----	------	-------------------------	-----------------	--------	--	-------	---

A type

3	A	40	DDA 203 A-40/0.03 110V	2CSB203199R1400	811701		0.350	1
3	A	63 ①	DDA 203 A-63/0.03 110V	2CSB203199R1630	811800		0.350	1
4	A	63 ①	DDA 204 A-63/0.03 110V	2CSB204199R1630	812104		0.350	1

400 V version

Number of poles	Rated residual current	Rated current	Order details	Bbn	Price	Price group	Weight	Pack unit
$I_{\Delta n}$ mA	In A	Type code	Order code	EAN	1 piece		1 piece	pc.

A type

2	A	63 ①	DDA 202 A-63/0.03 400V	2CSB202192R1630	954934		0.200	1
---	---	------	------------------------	-----------------	--------	--	-------	---

① provided with additional terminals for remote tripping

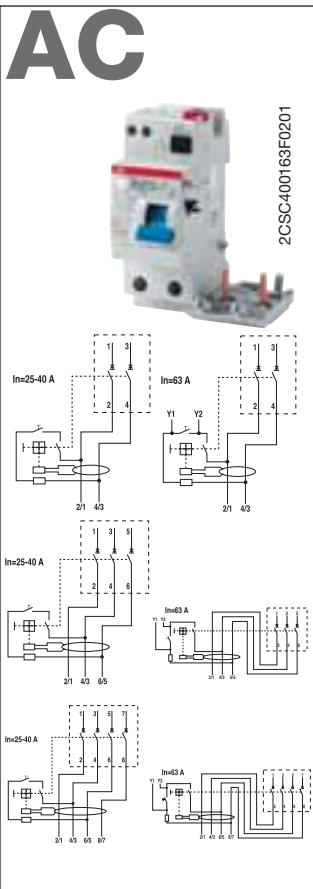

DDA 200 AP-R, AC type

Function: RCD-block for assembly on site with MCBs S 200 series. Protection against the effects of sinusoidal alternating earth fault currents, providing the best compromise between safety and continuity in the service thanks to the resistance to unwanted trippings; protection against indirect contacts and additional protection against direct (with $I_{\Delta n}=30$ mA) contacts.

Application: residential, commercial, industrial.

Standard: IEC/EN 61009 Ann. G

Surge current resistance (wave 8/20)=3000 A

Number of poles	Rated residual current $I_{\Delta n}$ mA	Rated current I_n A	Order details		Bbn 8012542	Price 1 piece	Price group	Weight 1 piece kg	Pack unit pc.
			Type code	Order code					
2	30	25	DDA202 AC-25/0.03 AP-R	2CSB202301R1250	800507			0.180	1
		40	DDA202 AC-40/0.03 AP-R	2CSB202301R1400	800606			0.180	1
		63 ①	DDA202 AC-63/0.03 AP-R	2CSB202301R1630	800705			0.180	1
3	30	25	DDA203 AC-25/0.03 AP-R	2CSB203301R1250	810704			0.220	1
		40	DDA203 AC-40/0.03 AP-R	2CSB203301R1400	810803			0.220	1
		63 ①	DDA203 AC-63/0.03 AP-R	2CSB203301R1630	810902			0.260	1
4	30	25	DDA204 AC-25/0.03 AP-R	2CSB204301R1250	800804			0.260	1
		40	DDA204 AC-40/0.03 AP-R	2CSB204301R1400	800903			0.260	1
		63 ①	DDA204 AC-63/0.03 AP-R	2CSB204301R1630	801009			0.305	1

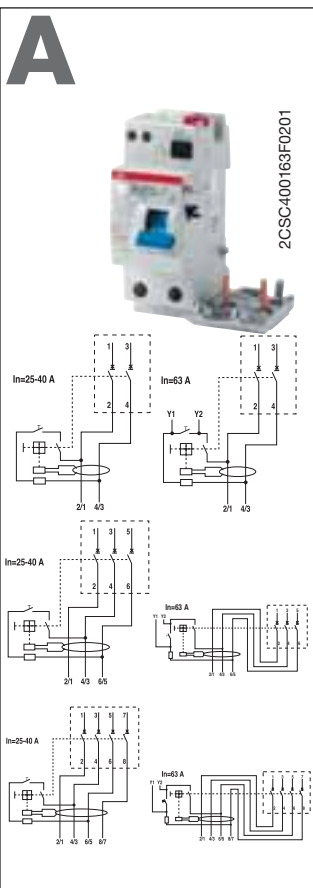

DDA 200 AP-R, A type

Function: RCD-block for assembly on site with MCBs S 200 series. Protection against the effects of sinusoidal alternating and direct pulsating earth fault currents, providing the best compromise between safety and continuity in the service thanks to the resistance to unwanted trippings; protection against indirect contacts and additional protection against direct (with $I_{\Delta n}=30$ mA) contacts.

Application: residential, commercial, industrial.

Standard: IEC/EN 61009 Ann. G

Surge current resistance (wave 8/20)=3000 A

Number of poles	Rated residual current $I_{\Delta n}$ mA	Rated current I_n A	Order details		Bbn 8012542	Price 1 piece	Price group	Weight 1 piece kg	Pack unit pc.
			Type code	Order code					
2	30	25	DDA202 A-25/0.03 AP-R	2CSB202401R1250	801108			0.180	1
		40	DDA202 A-40/0.03 AP-R	2CSB202401R1400	801207			0.180	1
		63 ①	DDA202 A-63/0.03 AP-R	2CSB202401R1630	801306			0.180	1
3	30	25	DDA203 A-25/0.03 AP-R	2CSB203401R1250	811008			0.220	1
		40	DDA203 A-40/0.03 AP-R	2CSB203401R1400	811107			0.220	1
		63 ①	DDA203 A-63/0.03 AP-R	2CSB203401R1630	811206			0.260	1
4	30	25	DDA204 A-25/0.03 AP-R	2CSB204401R1250	801405			0.260	1
		40	DDA204 A-40/0.03 AP-R	2CSB204401R1400	801504			0.260	1
		63 ①	DDA204 A-63/0.03 AP-R	2CSB204401R1630	801603			0.305	1

① provided with additional terminals for remote tripping

A



2CSC400163F0201

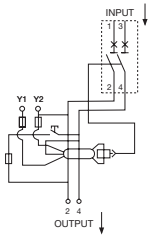

2CSC400563F0201

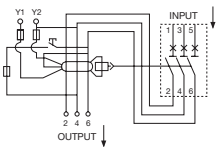

2CSC400562F0201

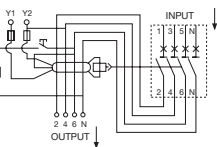

DDA 200 AE, A type

Function: RCD-block for assembly on site with MCBs S 200 series. Protection against the effects of sinusoidal alternating and direct pulsating earth fault currents; protection against indirect contacts and additional protection against direct (with $I\Delta n=30$ mA) contacts.

The RCD-block is provided with two additional terminals to be used in emergency circuits for remote opening in positive safety. A remote control circuit should be connected to those terminals where NC push buttons should be inserted in series.

ATTENTION!

It's allowed to use multiple NC buttons to control one DDA200 AE but it's not permitted to use one button in a control circuit for more RCD-blocks DDA200 AE. DDA200 AE must be supplied by the top side.

Application: commercial, industrial.

Standard: IEC/EN 61009 Ann. G

Number of poles	Rated residual current $I\Delta n$ mA	Rated current In A	Order details		Bhn 8012542	Price 1 piece	Price group	Weight 1 piece kg	Pack unit pc.
			Type code	Order code					
2	30	63	DDA202 A-63/0.03 AE	2CSB202701R1630	801702			0.180	1
	300	63	DDA202 A-63/0.3 AE	2CSB202701R3630	801801			0.180	1
	500	63	DDA202 A-63/0.5 AE	2CSB202701R4630	801900			0.180	1
	1000	63	DDA202 A-63/1 AE	2CSB202701R5630	802006			0.180	1

3	30	63	DDA203 A-63/0.03 AE	2CSB203701R1630	802105			0.260	1
	300	63	DDA203 A-63/0.3 AE	2CSB203701R3630	802204			0.260	1
	500	63	DDA203 A-63/0.5 AE	2CSB203701R4630	802303			0.260	1
	1000	63	DDA203 A-63/1 AE	2CSB203701R5630	802402			0.260	1

4	30	63	DDA204 A-63/0.03 AE	2CSB204701R1630	802501			0.305	1
	300	63	DDA204 A-63/0.3 AE	2CSB204701R3630	802600			0.305	1
	500	63	DDA204 A-63/0.5 AE	2CSB204701R4630	802709			0.305	1
	1000	63	DDA204 A-63/1 AE	2CSB204701R5630	802808			0.305	1

AC



2CSC400163F0201

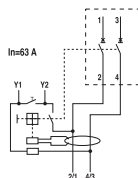

2CSC400563F0201

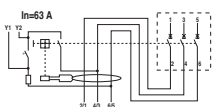

2CSC400662F0201

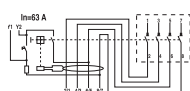

DDA 200 AC selective type

Function: RCD-block for assembly on site with MCBs S 200 series. Protection against the effects of sinusoidal alternating earth fault currents with an intentional tripping delay, which permits to realize the selectivity with downstream instantaneous devices (for more information about selectivity see the technical guide).

Application: commercial, industrial.

Standard: IEC/EN 61009 Ann. G

Surge current resistance (wave 8/20)=5000 A

Number of poles	Rated residual current I Δ n mA	Rated current In A	Order details		Bbn 8012542	Price 1 piece	Price group	Weight 1 piece kg	Pack unit pc.
			Type code	Order code					
2	100	63	DDA202 AC S-63/0.1	2CSB202901R2630	809500			0.180	1
	300	63	DDA202 AC S-63/0.3	2CSB202901R3630	809609			0.180	1
	500	63	DDA202 AC S-63/0.5	2CSB202901R4630	809708			0.180	1
	1000	63	DDA202 AC S-63/1	2CSB202901R5630	809807			0.180	1

3	100	63	DDA203 AC S-63/0.1	2CSB203901R2630	809906			0.260	1
	300	63	DDA203 AC S-63/0.3	2CSB203901R3630	810001			0.260	1
	500	63	DDA203 AC S-63/0.5	2CSB203901R4630	810100			0.260	1
	1000	63	DDA203 AC S-63/1	2CSB203901R5630	810209			0.260	1

4	100	63	DDA204 AC S-63/0.1	2CSB204901R2630	810308			0.305	1
	300	63	DDA204 AC S-63/0.3	2CSB204901R3630	810407			0.305	1
	500	63	DDA204 AC S-63/0.5	2CSB204901R4630	810506			0.305	1
	1000	63	DDA204 AC S-63/1	2CSB204901R5630	810605			0.305	1

Attention:
All DDA 200 AC S are provided with additional terminals for remote tripping

A



2CSC400163F0201

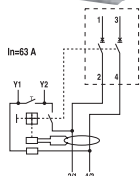

2CSC400563F0201

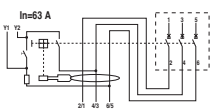

2CSC400562F0201

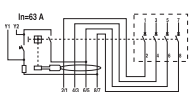

DDA 200 A selective type

Function: RCD-block for assembly on site with MCBs S 200 series. Protection against the effects of sinusoidal alternating and direct pulsating earth fault currents with an intentional tripping delay, which permits to realize the selectivity with downstream instantaneous devices (for more information about selectivity see the technical guide).

Application: commercial, industrial.

Standard: IEC/EN 61009 Ann. G

Surge current resistance (wave 8/20)=5000 A

Number of poles	Rated residual current $I_{\Delta n}$ mA	Rated current I_n A	Order details Type code	Order code	Bbn 8012542 EAN	Price 1 piece	Price group	Weight 1 piece kg	Pack unit pc.
2	100	63	DDA202 A S-63/0.1	2CSB202201R2630	799306			0.180	1
	300	63	DDA202 A S-63/0.3	2CSB202201R3630	799405			0.180	1
	500	63	DDA202 A S-63/0.5	2CSB202201R4630	799504			0.180	1
	1000	63	DDA202 A S-63/1	2CSB202201R5630	799603			0.180	1

3	100	63	DDA203 A S-63/0.1	2CSB203201R2630	799702			0.260	1
	300	63	DDA203 A S-63/0.3	2CSB203201R3630	799801			0.260	1
	500	63	DDA203 A S-63/0.5	2CSB203201R4630	799900			0.260	1
	1000	63	DDA203 A S-63/1	2CSB203201R5630	800002			0.260	1

4	100	63	DDA204 A S-63/0.1	2CSB204201R2630	800101			0.305	1
	300	63	DDA204 A S-63/0.3	2CSB204201R3630	800200			0.305	1
	500	63	DDA204 A S-63/0.5	2CSB204201R4630	800309			0.305	1
	1000	63	DDA204 A S-63/1	2CSB204201R5630	800408			0.305	1

Attention:

All DDA 200 A S are provided with additional terminals for remote tripping

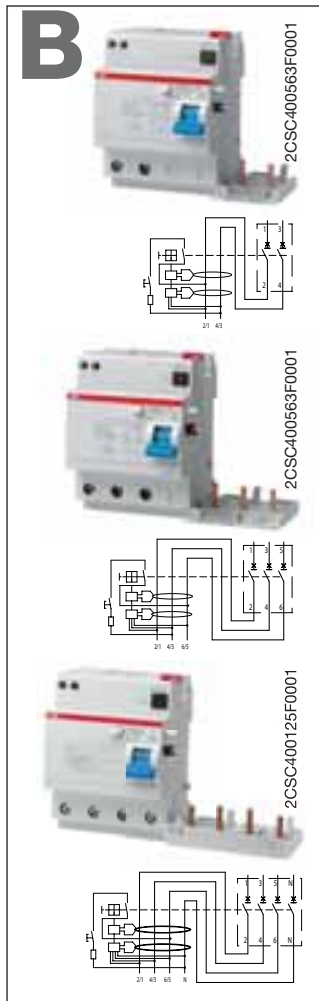

DDA 200 type B for continuous type fault currents

RCD-blocks type B are also sensitive to continuous or mainly continuous (continuous with weak ondulation) current pulsating earth fault currents. They are also sensitive to alternate sinusoidal and direct pulsating earth fault currents as with type A circuit breakers.

They satisfy the requirements of type A devices and thus the requirements for type AC devices which can be considered an extension. For this reason the differential blocks type B are sometimes referred as “universal type”, as sensitive to “all” kind of residual current shape.

DDA 200 type B can be coupled with all the S 200 series MCBs.

They are used for protection in installations with electronic equipments according to EN 50178.

Applications: tertiary and industrial.

Standards: IEC EN 61009 Ann. G, IEC 60755

Surge current resistance (8/20 wave): 3000 A

Number of poles	Rated residual current	Rated current	Order details		Bbn 8012542	Price 1 piece	Price group	Weight 1 piece	Pack unit
	I Δ n mA	In A	Type code	Order code	EAN		kg	pc.	
2	30	63	DDA202 B-63/0.03	2CSB202501R1630	987802		0.260	1	
	300	63	DDA202 B-63/0.3	2CSB202501R3630	987703		0.260	1	
3	30	63	DDA203 B-63/0.03	2CSB203501R1630	154754		0.325	1	
	300	63	DDA203 B-63/0.3	2CSB203501R3630	154853		0.325	1	
4	30	63	DDA204 B-63/0.03	2CSB204501R1630	987505		0.325	1	
	300	63	DDA204 B-63/0.3	2CSB204501R3630	987604		0.325	1	

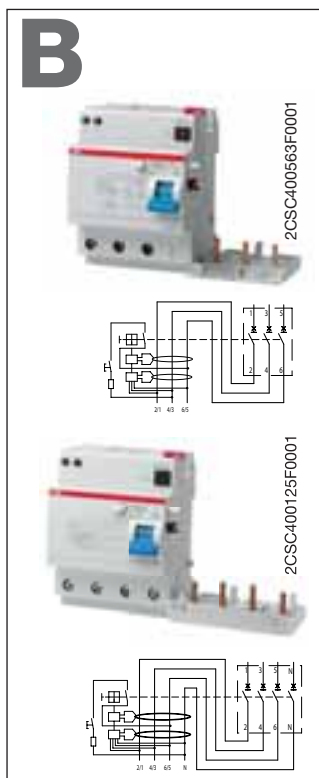

DDA 200 type B for selective continuous type fault currents

Function: protection against the effects of alternate sinusoidal, direct pulsating, continuous current and continuous current pulsating earth fault currents with an intentional trip delay that permits selectivity with instantaneous type devices placed downstream (for further information on selectivity, see chapter 10).

DDA 200 type B can be coupled with all the S 200 series MCBs.

They are used for protection in installations with electronic equipments according to EN 50178.

Applications: tertiary and industrial.

Standards: IEC EN 61009 Ann. G, IEC 60755

Surge current resistance (8/20 wave): 5000 A

Number of poles	Rated residual current	Rated current	Order details		Bbn 8012542	Price 1 piece	Price group	Weight 1 piece	Pack unit
	I Δ n mA	In A	Type code	Order code	EAN		kg	pc.	
3	300	63	DDA203 B S-63/0.3	2CSB203801R3630	987901		0.325	1	
4	300	63	DDA204 B S-63/0.3	2CSB204801R3630	154952		0.325	1	

3

TECHNICAL CHARACTERISTICS

	Standards		
Electrical features	Type (wave form of the earth leakage sensed)		
	Poles		
	Rated current I_n		A
	Rated sensitivity $I_{\Delta n}$		A
	Rated voltage U_e		V
	Insulation voltage U_i		V
	Max. operating voltage of circuit test		V
	Min. operating voltage of circuit test		V
	Rated frequency		Hz
	Rated breaking capacity acc. to IEC/EN 61009	ultimate I_{cn}	A
	Rated breaking capacity acc. to IEC/EN 60947-2	ultimate I_{cu}	kA
	1P+N @230 VAC	service I_{cs}	kA
	Rated residual breaking capacity $I_{\Delta m}$		kA
	Rated impulse withstand voltage (1.2/50) U_{imp}		kV
	Dielectric test voltage at ind. freq. for 1 min.		kV
Thermomagnetic release characteristic	B: $3 I_n \leq I_m \leq 5 I_n$ C: $5 I_n \leq I_m \leq 10 I_n$ K: $10 I_n \leq I_m \leq 14 I_n$		
Surge current resistance (wave 8/20)		A	
Mechanical features	Toggle		
	Flag indicators		
	Electrical life		
	Mechanical life		
	Protection degree	housing terminals	
	Tropicalization acc. to IEC /EN 60068-2	constant climatic conditions variable climatic conditions	°C/RH °C/RH
	Reference temperature for setting of thermal element		°C
	Ambient temperature (with daily average $\leq +35$ °C)		°C
	Storage temperature		°C
	Installation	Terminal type	top bottom
Terminal size top/bottom for cables			mm ²
Terminal size top/bottom for busbar			mm ²
Tightening torque top/bottom			N*m
Mounting Connection			
Dimensions and weight	Dimensions (H x D x W)		mm
	Weight		g
Combination with auxiliary elements	Combinable with:	auxiliary contact signal contact shunt trip undervoltage release	



DS201 L			DS201			DS201 M		
IEC / EN 61009								
AC	A	APR	AC	A	APR	AC	A	APR
6 ≤ In ≤ 32			1 ≤ In ≤ 40			4 ≤ In ≤ 40		
0.03-0.3	0.01-0.03-0.3	0.03	0.03-0.1-0.3-1	0.01-0.03-0.1-0.3	0.03-0.1-0.3	0.03-0.1-0.3	0.01-0.03-0.1-0.3	0.03-0.1-0.3
230-240								
500								
254								
110								
50...60								
4500			6000			10000		
6			10			10		
4.5			6			7.5		
4.5			6			6		
4								
2.5								
■	■	■	■ ■	■ ■ ■	■	■ ■	■ ■	■
250 (3000 for APR versions)								
black sealable in ON-OFF position								
differential trip indicator (blue)								
contact position indicator (green/red)								
10000								
20000								
IP4X								
IP2X								
23/83 - 40/93 - 55/20								
25/95 - 40/95								
30								
-25...+55								
-40...+70								
failsafe bi-directional cylinder-lift terminal at top and bottom (shock protected)								
failsafe bi-directional cylinder-lift terminal at top and bottom (shock protected)								
25/25								
10/10								
2.8								
on DIN rail EN 60715 (35 mm) by means of fast clip device								
from top and bottom								
85 x 69 x 35								
239								
yes								
yes								
yes								
yes								

C

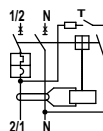

DS201 L AC type, C characteristic

Function: protection of end user single-phase circuits against overload and short-circuit currents; protection against the effects of sinusoidal alternating earth fault currents; protection against indirect contact and additional protection against direct contact ($I_{\Delta n}=30$ mA).

Application: residential, commercial, industrial.

Standard: IEC/EN 61009

$I_{cn}=4.5$ kA

Number of poles	Rated residual current $I_{\Delta n}$ mA	Rated current In A	Order details		Bbn 8012542	Price 1 piece	Price group	Weight 1 piece kg	Pack unit pc.
			Type code	Order code					
1+N	30	6	DS201 L C6 AC30	2CSR245040R1064	171201			0.240	5
		10	DS201 L C10 AC30	2CSR245040R1104	171300			0.240	5
		16	DS201 L C16 AC30	2CSR245040R1164	171409			0.240	5
		20	DS201 L C20 AC30	2CSR245040R1204	171508			0.240	5
		25	DS201 L C25 AC30	2CSR245040R1254	171607			0.240	5
		32	DS201 L C32 AC30	2CSR245040R1324	171706			0.240	5
	300	6	DS201 L C6 AC300	2CSR245040R3064	171805			0.240	5
		10	DS201 L C10 AC300	2CSR245040R3104	171904			0.240	5
		16	DS201 L C16 AC300	2CSR245040R3164	172000			0.240	5
		20	DS201 L C20 AC300	2CSR245040R3204	172109			0.240	5
		25	DS201 L C25 AC300	2CSR245040R3254	172208			0.240	5
		32	DS201 L C32 AC300	2CSR245040R3324	172307			0.240	5

C

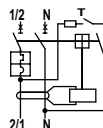

DS201 L A type, C characteristic

Function: protection of end user single-phase circuits against overload and short-circuit currents; protection against the effects of sinusoidal alternating earth fault currents; protection against indirect contact and additional protection against direct contact ($I_{\Delta n}=30$ mA).

Application: residential, commercial, industrial.

Standard: IEC/EN 61009

$I_{cn}=4.5$ kA

Number of poles	Rated residual current $I_{\Delta n}$ mA	Rated current In A	Order details		Bbn 8012542	Price 1 piece	Price group	Weight 1 piece kg	Pack unit pc.
			Type code	Order code					
1+N	10	6	DS201 L C6 A10	2CSR245140R0064	163404			0.240	5
		10	DS201 L C10 A10	2CSR245140R0104	171003			0.240	5
		16	DS201 L C16 A10	2CSR245140R0164	171102			0.240	5
	30	6	DS201 L C6 A30	2CSR245140R1064	172406			0.240	5
		10	DS201 L C10 A30	2CSR245140R1104	172505			0.240	5
		16	DS201 L C16 A30	2CSR245140R1164	172604			0.240	5
		20	DS201 L C20 A30	2CSR245140R1204	172703			0.240	5
		25	DS201 L C25 A30	2CSR245140R1254	173809			0.240	5
		32	DS201 L C32 A30	2CSR245140R1324	173908			0.240	5
	300	6	DS201 L C6 A300	2CSR245140R3064	174004			0.240	5
		10	DS201 L C10 A300	2CSR245140R3104	174103			0.240	5
		16	DS201 L C16 A300	2CSR245140R3164	174202			0.240	5
		20	DS201 L C20 A300	2CSR245140R3204	174301			0.240	5
		25	DS201 L C25 A300	2CSR245140R3254	174707			0.240	5
		32	DS201 L C32 A300	2CSR245140R3324	174806			0.240	5

C

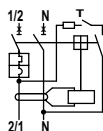

DS201 L APR type, C characteristic

Function: protection against the effects of sinusoidal alternating earth fault currents, providing an optimal trade-off between safety and continuity of service, thanks to the resistance to unwanted tripping; protection against indirect contact and additional protection against direct ($I_{\Delta n}=30\text{mA}$) contact; protection and isolation of resistive and inductive loads.

Application: residential, commercial, industrial.

Standard: IEC/EN 61009

Icn=4.5 kA

Number of poles	Rated residual current $I_{\Delta n}$ mA	Rated current I_n A	Order details		Bbn	Price	Price	Weight	Pack
			Type code	Order code	8012542	1 piece	group	1 piece	unit
					EAN			kg	pc.
1+N	30	6	DS201 L C6 APR30	2CSR245440R1064	174905			0.240	5
		10	DS201 L C10 APR30	2CSR245440R1104	175001			0.240	5
		16	DS201 L C16 APR30	2CSR245440R1164	175100			0.240	5
		20	DS201 L C20 APR30	2CSR245440R1204	175209			0.240	5
		25	DS201 L C25 APR30	2CSR245440R1254	175605			0.240	5
		32	DS201 L C32 APR30	2CSR245440R1324	175704			0.240	5

3

B



DS201 AC type, B characteristic

Function: protection of end user single-phase circuits against overload and short-circuit currents; protection against the effects of sinusoidal alternating and direct pulsating earth fault currents; protection against indirect contact and additional protection against direct contact ($I_{\Delta n}=30$ mA).

Application: residential, commercial, industrial.

Standard: IEC/EN 61009

$I_{cn}=6$ kA

Number of poles	Rated residual current $I_{\Delta n}$ mA	Rated current In A	Order details		Bbn 8012542	Price 1 piece	Price group	Weight 1 piece kg	Pack unit pc.
			Type code	Order code					
1+N	30	6	DS201 B6 AC30	2CSR255040R1065	279709			0.240	5
			DS201 B10 AC30	2CSR255040R1105	280309		0.240	5	
		10	DS201 B13 AC30	2CSR255040R1135	285205		0.240	5	
			DS201 B16 AC30	2CSR255040R1165	285304		0.240	5	
		20	DS201 B20 AC30	2CSR255040R1205	285403		0.240	5	
			DS201 B25 AC30	2CSR255040R1255	285502		0.240	5	
		32	DS201 B32 AC30	2CSR255040R1325	285601		0.240	5	
			DS201 B40 AC30	2CSR255040R1405	285700		0.240	5	
	100	6	DS201 B6 AC100	2CSR255040R2065	285809		0.240	5	
			DS201 B10 AC100	2CSR255040R2105	285908		0.240	5	
		10	DS201 B13 AC100	2CSR255040R2135	286004		0.240	5	
			DS201 B16 AC100	2CSR255040R2165	286103		0.240	5	
		20	DS201 B20 AC100	2CSR255040R2205	286202		0.240	5	
			DS201 B25 AC100	2CSR255040R2255	286301		0.240	5	
		32	DS201 B32 AC100	2CSR255040R2325	286400		0.240	5	
			DS201 B40 AC100	2CSR255040R2405	286509		0.240	5	
300	6	DS201 B6 AC300	2CSR255040R3065	286608		0.240	5		
		DS201 B10 AC300	2CSR255040R3105	286707		0.240	5		
	10	DS201 B13 AC300	2CSR255040R3135	293903		0.240	5		
		DS201 B16 AC300	2CSR255040R3165	294009		0.240	5		
	20	DS201 B20 AC300	2CSR255040R3205	294108		0.240	5		
		DS201 B25 AC300	2CSR255040R3255	294207		0.240	5		
	32	DS201 B32 AC300	2CSR255040R3325	294306		0.240	5		
		DS201 B40 AC300	2CSR255040R3405	294405		0.240	5		

C

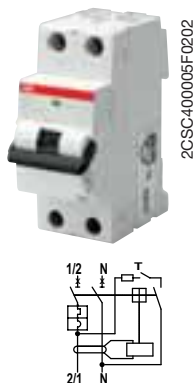

DS201 AC type, C characteristic

Function: protection of end user single-phase circuits against overload and short-circuit currents; protection against the effects of sinusoidal alternating earth fault currents; protection against indirect contact and additional protection against direct contact ($I_{\Delta n}=30$ mA).

Application: residential, commercial, industrial.

Standard: IEC/EN 61009

$I_{cn}=6$ kA

Number of poles	Rated residual current $I_{\Delta n}$ mA	Rated current In A	Order details		Bbn 8012542	Price 1 piece	Price group	Weight 1 piece kg	Pack unit pc.
			Type code	Order code					
1+N	30	6	DS201 C6 AC30	2CSR255040R1064	294504			0.240	5
			DS201 C10 AC30	2CSR255040R1104	294603		0.240	5	
		10	DS201 C13 AC30	2CSR255040R1134	294702		0.240	5	
			DS201 C16 AC30	2CSR255040R1164	294801		0.240	5	
		20	DS201 C20 AC30	2CSR255040R1204	294900		0.240	5	
			DS201 C25 AC30	2CSR255040R1254	295006		0.240	5	
		32	DS201 C32 AC30	2CSR255040R1324	296003		0.240	5	
			DS201 C40 AC30	2CSR255040R1404	296102		0.240	5	

100	6	DS201 C6 AC100	2CSR255040R2064	296201	0.240	5
	10	DS201 C10 AC100	2CSR255040R2104	296409	0.240	5
	13	DS201 C13 AC100	2CSR255040R2134	370802	0.240	5
	16	DS201 C16 AC100	2CSR255040R2164	370901	0.240	5
	20	DS201 C20 AC100	2CSR255040R2204	371601	0.240	5
	25	DS201 C25 AC100	2CSR255040R2254	371700	0.240	5
	32	DS201 C32 AC100	2CSR255040R2324	371809	0.240	5
300	40	DS201 C40 AC100	2CSR255040R2404	498100	0.240	5
	6	DS201 C6 AC300	2CSR255040R3064	498209	0.240	5
	10	DS201 C10 AC300	2CSR255040R3104	498308	0.240	5
	13	DS201 C13 AC300	2CSR255040R3134	505907	0.240	5
	16	DS201 C16 AC300	2CSR255040R3164	506003	0.240	5
	20	DS201 C20 AC300	2CSR255040R3204	506102	0.240	5
	25	DS201 C25 AC300	2CSR255040R3254	506201	0.240	5
1000	32	DS201 C32 AC300	2CSR255040R3324	618300	0.240	5
	40	DS201 C40 AC300	2CSR255040R3404	638407	0.240	5
	6	DS201 C6 AC1000	2CSR255040R5064	996606	0.240	5
	10	DS201 C10 AC1000	2CSR255040R5104	996705	0.240	5
	16	DS201 C16 AC1000	2CSR255040R5164	996804	0.240	5
	20	DS201 C20 AC1000	2CSR255040R5204	996903	0.240	5
	25	DS201 C25 AC1000	2CSR255040R5254	997009	0.240	5
	32	DS201 C32 AC1000	2CSR255040R5324	997108	0.240	5
	40	DS201 C40 AC1000	2CSR255040R5404	997207	0.240	5

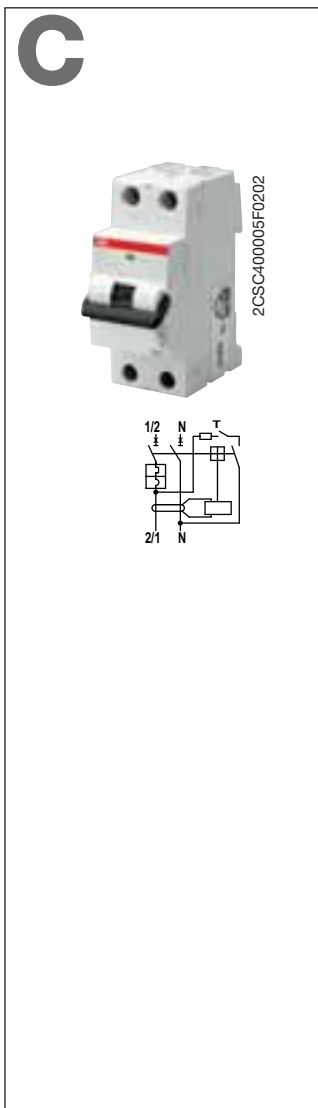

DS201 APR type, C characteristic

Function: protection against the effects of sinusoidal alternating earth fault currents, providing an optimal trade-off between safety and continuity of service thanks to the resistance to unwanted tripping; protection against indirect contact and additional protection against direct ($I_{\Delta n}=30$ mA) contact; protection and isolation of resistive and inductive loads.

Application: residential, commercial, industrial.

Standard: IEC/EN 61009

I_{cn}=6 kA

Number of poles	Rated residual current $I_{\Delta n}$ mA	Rated current In A	Order details		Bbn	Price	Price	Weight	Pack
			Type code	Order code	8012542	1 piece	group	1 piece	unit
					EAN			kg	pc.
1+N	30	6	DS201 C6 APR30	2CSR255440R1064	997306			0.240	5
		10	DS201 C10 APR30	2CSR255440R1104	997405			0.240	5
		13	DS201 C13 APR30	2CSR255440R1134	997504			0.240	5
		16	DS201 C16 APR30	2CSR255440R1164	997603			0.240	5
		20	DS201 C20 APR30	2CSR255440R1204	997702			0.240	5
		25	DS201 C25 APR30	2CSR255440R1254	997801			0.240	5
		32	DS201 C32 APR30	2CSR255440R1324	997900			0.240	5
100	40	6	DS201 C6 APR100	2CSR255440R2064	126454			0.240	5
		10	DS201 C10 APR100	2CSR255440R2104	126553			0.240	5
		13	DS201 C13 APR100	2CSR255440R2134	126652			0.240	5
		16	DS201 C16 APR100	2CSR255440R2164	126751			0.240	5
		20	DS201 C20 APR100	2CSR255440R2204	126850			0.240	5
		25	DS201 C25 APR100	2CSR255440R2254	126959			0.240	5
		32	DS201 C32 APR100	2CSR255440R2324	127055			0.240	5
300	40	6	DS201 C6 APR300	2CSR255440R3064	998105			0.240	5
		10	DS201 C10 APR300	2CSR255440R3104	998204			0.240	5
		13	DS201 C13 APR300	2CSR255440R3134	998303			0.240	5
		16	DS201 C16 APR300	2CSR255440R3164	998402			0.240	5
		20	DS201 C20 APR300	2CSR255440R3204	998501			0.240	5
		25	DS201 C25 APR300	2CSR255440R3254	998600			0.240	5
		32	DS201 C32 APR300	2CSR255440R3324	998709			0.240	5
	40	6	DS201 C6 APR1000	2CSR255440R5064	996606			0.240	5
		10	DS201 C10 APR1000	2CSR255440R5104	996705			0.240	5

B

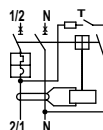

DS201 A type, B characteristic

Function: protection of end user single-phase circuits against overload and short-circuit currents; protection against the effects of sinusoidal alternating and direct pulsating earth fault currents; protection against indirect contact and additional protection against direct contact ($I_{\Delta n}=30$ mA).

Application: residential, commercial, industrial.

Standard: IEC/EN 61009

$I_{cn}=6$ kA

Number of poles	Rated residual current $I_{\Delta n}$ mA	Rated current In A	Order details		Bbn 8012542	Price 1 piece	Price group	Weight 1 piece kg	Pack unit pc.
			Type code	Order code					
1+N	10	10	DS201 B10 A10	2CSR255140R0105	995708			0.240	5
		13	DS201 B13 A10	2CSR255140R0135	995807		0.240	5	
		16	DS201 B16 A10	2CSR255140R0165	995906		0.240	5	
	30	30	6	DS201 B6 A30	2CSR255140R1065	638506		0.240	5
			10	DS201 B10 A30	2CSR255140R1105	647805		0.240	5
			13	DS201 B13 A30	2CSR255140R1135	655503		0.240	5
			16	DS201 B16 A30	2CSR255140R1165	655602		0.240	5
			20	DS201 B20 A30	2CSR255140R1205	655701		0.240	5
			25	DS201 B25 A30	2CSR255140R1255	766902		0.240	5
			32	DS201 B32 A30	2CSR255140R1325	814504		0.240	5
	100	100	40	DS201 B40 A30	2CSR255140R1405	910602		0.240	5
			6	DS201 B6 A100	2CSR255140R2065	990307		0.240	5
10			DS201 B10 A100	2CSR255140R2105	990406		0.240	5	
13			DS201 B13 A100	2CSR255140R2135	990505		0.240	5	
16			DS201 B16 A100	2CSR255140R2165	990604		0.240	5	
20			DS201 B20 A100	2CSR255140R2205	990703		0.240	5	
25			DS201 B25 A100	2CSR255140R2255	990802		0.240	5	
300	300	32	DS201 B32 A100	2CSR255140R2325	990901		0.240	5	
		40	DS201 B40 A100	2CSR255140R2405	991007		0.240	5	
		6	DS201 B6 A300	2CSR255140R3065	991908		0.240	5	
		10	DS201 B10 A300	2CSR255140R3105	992004		0.240	5	
		13	DS201 B13 A300	2CSR255140R3135	992103		0.240	5	
		16	DS201 B16 A300	2CSR255140R3165	992202		0.240	5	
		20	DS201 B20 A300	2CSR255140R3205	992301		0.240	5	
		25	DS201 B25 A300	2CSR255140R3255	992400		0.240	5	
		32	DS201 B32 A300	2CSR255140R3325	992509		0.240	5	
		40	DS201 B40 A300	2CSR255140R3405	992608		0.240	5	

C

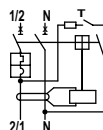

DS201 A type, C characteristic

Function: protection of end user single-phase circuits against overload and short-circuit currents; protection against the effects of sinusoidal alternating and direct pulsating earth fault currents; protection against indirect contact and additional protection against direct contact ($I_{\Delta n}=30$ mA).

Application: residential, commercial, industrial.

Standard: IEC/EN 61009

$I_{cn}=6$ kA

Number of poles	Rated residual current $I_{\Delta n}$ mA	Rated current In A	Order details		Bbn 8012542	Price 1 piece	Price group	Weight 1 piece kg	Pack unit pc.
			Type code	Order code					
1+N	10	10	DS201 C10 A10	2CSR255140R0104	996002			0.240	5
		13	DS201 C13 A10	2CSR255140R0134	996101		0.240	5	
		16	DS201 C16 A10	2CSR255140R0164	996200		0.240	5	
30	30	2	DS201 C2 A30	2CSR255140R1024	123958		0.240	5	
		4	DS201 C4 A30	2CSR255140R1044	942306		0.240	5	
		6	DS201 C6 A30	2CSR255140R1064	942405		0.240	5	
		8	DS201 C8 A30	2CSR255140R1084	124054		0.240	5	
		10	DS201 C10 A30	2CSR255140R1104	952503		0.240	5	
		13	DS201 C13 A30	2CSR255140R1134	976004		0.240	5	
		16	DS201 C16 A30	2CSR255140R1164	976103		0.240	5	

	20	DS201 C20 A30	2CSR255140R1204	976202	0.240	5
	25	DS201 C25 A30	2CSR255140R1254	976301	0.240	5
	32	DS201 C32 A30	2CSR255140R1324	990109	0.240	5
	40	DS201 C40 A30	2CSR255140R1404	990208	0.240	5
100	6	DS201 C6 A100	2CSR255140R2064	991106	0.240	5
	10	DS201 C10 A100	2CSR255140R2104	991205	0.240	5
	13	DS201 C13 A100	2CSR255140R2134	991304	0.240	5
	16	DS201 C16 A100	2CSR255140R2164	991403	0.240	5
	20	DS201 C20 A100	2CSR255140R2204	991502	0.240	5
	25	DS201 C25 A100	2CSR255140R2254	991601	0.240	5
	32	DS201 C32 A100	2CSR255140R2324	991700	0.240	5
	40	DS201 C40 A100	2CSR255140R2404	991809	0.240	5
300	2	DS201 C2 A300	2CSR255140R3024	124153	0.240	5
	4	DS201 C4 A300	2CSR255140R3044	124252	0.240	5
	6	DS201 C6 A300	2CSR255140R3064	992707	0.240	5
	8	DS201 C8 A300	2CSR255140R3084	124351	0.240	5
	10	DS201 C10 A300	2CSR255140R3104	992806	0.240	5
	13	DS201 C13 A300	2CSR255140R3134	992905	0.240	5
	16	DS201 C16 A300	2CSR255140R3164	993001	0.240	5
	20	DS201 C20 A300	2CSR255140R3204	993100	0.240	5
	25	DS201 C25 A300	2CSR255140R3254	993209	0.240	5
	32	DS201 C32 A300	2CSR255140R3324	993308	0.240	5
	40	DS201 C40 A300	2CSR255140R3404	993407	0.240	5

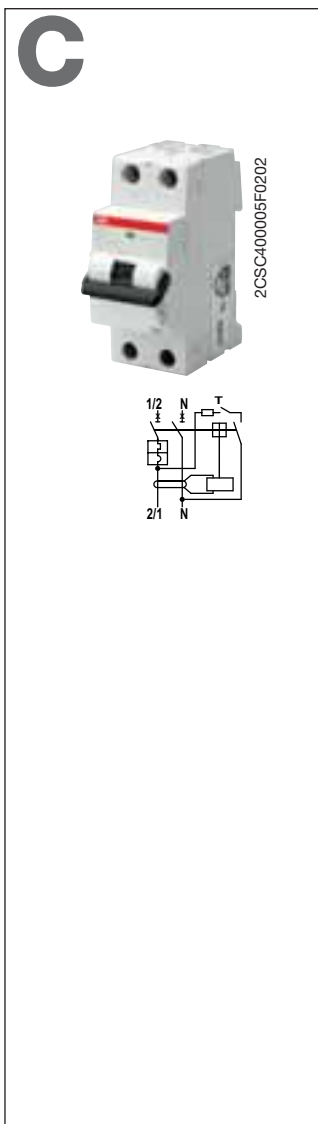

DS201 A type, K characteristic

Function: protection of end user single-phase circuits against overload and short-circuit currents; protection against the effects of sinusoidal alternating earth fault currents; protection against indirect contact and additional protection against direct contact ($I_{\Delta n}=30$ mA).

Application: residential, commercial, industrial.

Standard: IEC/EN 60947-2

I_{cn}=6 kA

Number of poles	Rated residual current $I_{\Delta n}$ mA	Rated current In A	Order details		Bbn 8012542	Price 1 piece	Price group	Weight 1 piece kg	Pack unit pc.
			Type code	Order code					
1+N	10	10	DS201 K10 A10	2CSR255140R0107	996309			0.240	5
		13	DS201 K13 A10	2CSR255140R0137	996408			0.240	5
		16	DS201 K16 A10	2CSR255140R0167	996507			0.240	5
30	30	1	DS201 K1 A30	2CSR255140R1017	993506			0.240	5
		2	DS201 K2 A30	2CSR255140R1027	993605			0.240	5
		4	DS201 K4 A30	2CSR255140R1047	993704			0.240	5
		6	DS201 K6 A30	2CSR255140R1067	993803			0.240	5
		8	DS201 K8 A30	2CSR255140R1087	123750			0.240	5
		10	DS201 K10 A30	2CSR255140R1107	993902			0.240	5
		13	DS201 K13 A30	2CSR255140R1137	994008			0.240	5
		16	DS201 K16 A30	2CSR255140R1167	994107			0.240	5
		20	DS201 K20 A30	2CSR255140R1207	994206			0.240	5
		25	DS201 K25 A30	2CSR255140R1257	994305			0.240	5
		32	DS201 K32 A30	2CSR255140R1327	994404			0.240	5
		40	DS201 K40 A30	2CSR255140R1407	994503			0.240	5
		300	300	1	DS201 K1 A300	2CSR255140R3017	994602		
2	DS201 K2 A300			2CSR255140R3027	994701			0.240	5
4	DS201 K4 A300			2CSR255140R3047	994800			0.240	5
6	DS201 K6 A300			2CSR255140R3067	994909			0.240	5
8	DS201 K8 A300			2CSR255140R3087	123859			0.240	5
10	DS201 K10 A300			2CSR255140R3107	995005			0.240	5
13	DS201 K13 A300			2CSR255140R3137	995104			0.240	5
16	DS201 K16 A300			2CSR255140R3167	995203			0.240	5
20	DS201 K20 A300			2CSR255140R3207	995302			0.240	5
25	DS201 K25 A300			2CSR255140R3257	995401			0.240	5
32	DS201 K32 A300			2CSR255140R3327	995500			0.240	5
40	DS201 K40 A300	2CSR255140R3407	995609			0.240	5		

B

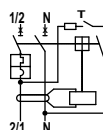

DS201 M AC type, B characteristic

Function: protection of end user single-phase circuits against overload and short-circuit currents; protection against the effects of sinusoidal alternating earth fault currents; protection against indirect contact and additional protection against direct contact ($I_{\Delta n}=30$ mA).

Application: residential, commercial, industrial.

Standard: IEC/EN 61009

$I_{cn}=10$ kA

Number of poles	Rated residual current $I_{\Delta n}$ mA	Rated current In A	Order details		Bbn 8012542	Price 1 piece	Price group	Weight 1 piece	Pack unit	
			Type code	Order code						EAN
1+N	30	6	DS201 M B6 AC30	2CSR275040R1065	998907			0.240	5	
		10	DS201 M B10 AC30	2CSR275040R1105	999003			0.240	5	
		13	DS201 M B13 AC30	2CSR275040R1135	999102			0.240	5	
		16	DS201 M B16 AC30	2CSR275040R1165	999201			0.240	5	
		20	DS201 M B20 AC30	2CSR275040R1205	999300			0.240	5	
		25	DS201 M B25 AC30	2CSR275040R1255	999409			0.240	5	
	100	30	32	DS201 M B32 AC30	2CSR275040R1325	999508			0.240	5
			40	DS201 M B40 AC30	2CSR275040R1405	999607			0.240	5
			6	DS201 M B6 AC100	2CSR275040R2065	106159			0.240	5
			10	DS201 M B10 AC100	2CSR275040R2105	106258			0.240	5
			13	DS201 M B13 AC100	2CSR275040R2135	106357			0.240	5
			16	DS201 M B16 AC100	2CSR275040R2165	106456			0.240	5
300	30	20	DS201 M B20 AC100	2CSR275040R2205	106555			0.240	5	
		25	DS201 M B25 AC100	2CSR275040R2255	106654			0.240	5	
		32	DS201 M B32 AC100	2CSR275040R2325	106753			0.240	5	
		40	DS201 M B40 AC100	2CSR275040R2405	106852			0.240	5	
		6	DS201 M B6 AC300	2CSR275040R3065	107750			0.240	5	
		10	DS201 M B10 AC300	2CSR275040R3105	107859			0.240	5	
	300	30	13	DS201 M B13 AC300	2CSR275040R3135	107958			0.240	5
			16	DS201 M B16 AC300	2CSR275040R3165	108054			0.240	5
			20	DS201 M B20 AC300	2CSR275040R3205	108153			0.240	5
			25	DS201 M B25 AC300	2CSR275040R3255	108252			0.240	5
			32	DS201 M B32 AC300	2CSR275040R3325	108351			0.240	5
			40	DS201 M B40 AC300	2CSR275040R3405	108450			0.240	5

C

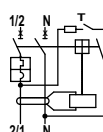

DS201 M AC type, C characteristic

Function: protection of end user single-phase circuits against overload and short-circuit currents; protection against the effects of sinusoidal alternating earth fault currents; protection against indirect contact and additional protection against direct contact ($I_{\Delta n}=30$ mA).

Application: residential, commercial, industrial.

Standard: IEC/EN 61009

$I_{cn}=10$ kA

Number of poles	Rated residual current $I_{\Delta n}$ mA	Rated current In A	Order details		Bbn 8012542	Price 1 piece	Price group	Weight 1 piece	Pack unit
			Type code	Order code					
1+N	30	6	DS201 M C6 AC30	2CSR275040R1064	999706			0.240	5
		10	DS201 M C10 AC30	2CSR275040R1104	999805			0.240	5
		13	DS201 M C13 AC30	2CSR275040R1134	999904			0.240	5
		16	DS201 M C16 AC30	2CSR275040R1164	105657			0.240	5
		20	DS201 M C20 AC30	2CSR275040R1204	105756			0.240	5
		25	DS201 M C25 AC30	2CSR275040R1254	105855			0.240	5
		32	DS201 M C32 AC30	2CSR275040R1324	105954			0.240	5
		40	DS201 M C40 AC30	2CSR275040R1404	106050			0.240	5

100	6	DS201 M C6 AC100	2CSR275040R2064	106951	0.240	5
	10	DS201 M C10 AC100	2CSR275040R2104	107057	0.240	5
	13	DS201 M C13 AC100	2CSR275040R2134	107156	0.240	5
	16	DS201 M C16 AC100	2CSR275040R2164	107255	0.240	5
	20	DS201 M C20 AC100	2CSR275040R2204	107354	0.240	5
	25	DS201 M C25 AC100	2CSR275040R2254	107453	0.240	5
	32	DS201 M C32 AC100	2CSR275040R2324	107552	0.240	5
	40	DS201 M C40 AC100	2CSR275040R2404	107651	0.240	5
300	6	DS201 M C6 AC300	2CSR275040R3064	108559	0.240	5
	10	DS201 M C10 AC300	2CSR275040R3104	108658	0.240	5
	13	DS201 M C13 AC300	2CSR275040R3134	108757	0.240	5
	16	DS201 M C16 AC300	2CSR275040R3164	108856	0.240	5
	20	DS201 M C20 AC300	2CSR275040R3204	108955	0.240	5
	25	DS201 M C25 AC300	2CSR275040R3254	109051	0.240	5
	32	DS201 M C32 AC300	2CSR275040R3324	109150	0.240	5
	40	DS201 M C40 AC300	2CSR275040R3404	109259	0.240	5

3

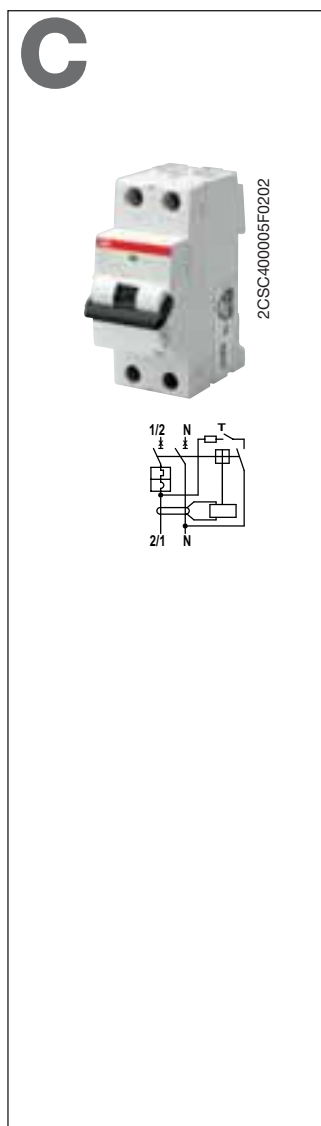

DS201 M APR type, C characteristic

Function: protection against the effects of sinusoidal alternating earth fault currents, providing an optimal compromise between safety and continuity of service, thanks to the resistance to unwanted tripping; protection against indirect contact and additional protection against direct ($I_{\Delta n}=30$ mA) contact; protection and isolation of resistive and inductive loads.

Application: residential, commercial, industrial.

Standard: IEC/EN 61009

$I_{cn}=10$ kA

Number of poles	Rated residual current $I_{\Delta n}$ mA	Rated current In A	Order details		Bbn 8012542	Price 1 piece	Price group	Weight 1 piece kg	Pack unit pc.
			Type code	Order code					
1+N	30	6	DS201 M C6 APR30	2CSR275440R1064	114154			0.240	5
		10	DS201 M C10 APR30	2CSR275440R1104	114253			0.240	5
		13	DS201 M C13 APR30	2CSR275440R1134	114352			0.240	5
		16	DS201 M C16 APR30	2CSR275440R1164	114451			0.240	5
		20	DS201 M C20 APR30	2CSR275440R1204	114550			0.240	5
		25	DS201 M C25 APR30	2CSR275440R1254	114659			0.240	5
		32	DS201 M C32 APR30	2CSR275440R1324	114758			0.240	5
		40	DS201 M C40 APR30	2CSR275440R1404	114857			0.240	5
100	6	6	DS201 M C6 APR100	2CSR275440R2064	127253			0.240	5
		10	DS201 M C10 APR100	2CSR275440R2104	127352			0.240	5
		13	DS201 M C13 APR100	2CSR275440R2134	127451			0.240	5
		16	DS201 M C16 APR100	2CSR275440R2164	127550			0.240	5
		20	DS201 M C20 APR100	2CSR275440R2204	127659			0.240	5
		25	DS201 M C25 APR100	2CSR275440R2254	127758			0.240	5
		32	DS201 M C32 APR100	2CSR275440R2324	127857			0.240	5
		40	DS201 M C40 APR100	2CSR275440R2404	127956			0.240	5
300	6	6	DS201 M C6 APR300	2CSR275440R3064	114956			0.240	5
		10	DS201 M C10 APR300	2CSR275440R3104	115052			0.240	5
		13	DS201 M C13 APR300	2CSR275440R3134	115151			0.240	5
		16	DS201 M C16 APR300	2CSR275440R3164	115250			0.240	5
		20	DS201 M C20 APR300	2CSR275440R3204	115359			0.240	5
		25	DS201 M C25 APR300	2CSR275440R3254	115458			0.240	5
		32	DS201 M C32 APR300	2CSR275440R3324	115557			0.240	5
		40	DS201 M C40 APR300	2CSR275440R3404	115656			0.240	5

B

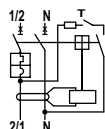

DS201 M A type, B characteristic

Function: protection of end user single-phase circuits against overload and short-circuit currents; protection against the effects of sinusoidal alternating and direct pulsating earth fault currents; protection against indirect contact and additional protection against direct contact ($I_{\Delta n}=30$ mA).

Application: residential, commercial, industrial.

Standard: IEC/EN 61009

$I_{cn}=10$ kA

Number of poles	Rated residual current $I_{\Delta n}$ mA	Rated current I_n A	Order details	Bbn 8012542	Price 1 piece	Price group	Weight 1 piece	Pack unit	
			Type code	Order code	EAN		kg	pc.	
1+N	10	10	DS201 M B10 A10	2CSR275140R0105	124450		0.240	5	
		16	DS201 M B16 A10	2CSR275140R0165	124559		0.240	5	
	30	6	DS201 M B6 A30	2CSR275140R1065	109358			0.240	5
		10	DS201 M B10 A30	2CSR275140R1105	109457			0.240	5
		13	DS201 M B13 A30	2CSR275140R1135	109556			0.240	5
		16	DS201 M B16 A30	2CSR275140R1165	109655			0.240	5
		20	DS201 M B20 A30	2CSR275140R1205	109754			0.240	5
		25	DS201 M B25 A30	2CSR275140R1255	109853			0.240	5
		32	DS201 M B32 A30	2CSR275140R1325	109952			0.240	5
		40	DS201 M B40 A30	2CSR275140R1405	110057			0.240	5
	100	6	DS201 M B6 A100	2CSR275140R2065	111054			0.240	5
		10	DS201 M B10 A100	2CSR275140R2105	111153			0.240	5
		13	DS201 M B13 A100	2CSR275140R2135	111252			0.240	5
		16	DS201 M B16 A100	2CSR275140R2165	111351			0.240	5
		20	DS201 M B20 A100	2CSR275140R2205	111450			0.240	5
		25	DS201 M B25 A100	2CSR275140R2255	111559			0.240	5
32		DS201 M B32 A100	2CSR275140R2325	111658			0.240	5	
40		DS201 M B40 A100	2CSR275140R2405	111757			0.240	5	
300	6	DS201 M B6 A300	2CSR275140R3065	112556			0.240	5	
	10	DS201 M B10 A300	2CSR275140R3105	112655			0.240	5	
	13	DS201 M B13 A300	2CSR275140R3135	112754			0.240	5	
	16	DS201 M B16 A300	2CSR275140R3165	112853			0.240	5	
	20	DS201 M B20 A300	2CSR275140R3205	112952			0.240	5	
	25	DS201 M B25 A300	2CSR275140R3255	113058			0.240	5	
	32	DS201 M B32 A300	2CSR275140R3325	113157			0.240	5	
	40	DS201 M B40 A300	2CSR275140R3405	113256			0.240	5	

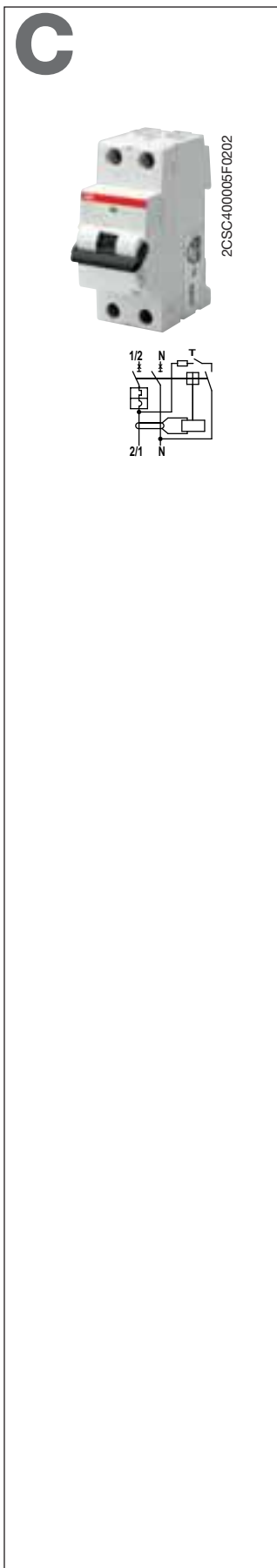

DS201 M A type, C characteristic

Function: protection of end user single-phase circuits against overload and short-circuit currents; protection against the effects of sinusoidal alternating and direct pulsating earth fault currents; protection against indirect contact and additional protection against direct contact ($I_{\Delta n}=30$ mA).

Application: residential, commercial, industrial.

Standard: IEC/EN 61009

I_{cn}=10 kA

Number of poles	Rated residual current $I_{\Delta n}$ mA	Rated current I_n A	Order details		Bbn 8012542	Price 1 piece	Price group	Weight 1 piece kg	Pack unit pc.	
			Type code	Order code						EAN
1+N	10	10	DS201 M C10 A10	2CSR275140R0104	124658			0.240	5	
		16	DS201 M C16 A10	2CSR275140R0164	124757			0.240	5	
	30	4	4	DS201 M C4 A30	2CSR275140R1044	110156			0.240	5
			6	DS201 M C6 A30	2CSR275140R1064	110255			0.240	5
		10	DS201 M C10 A30	2CSR275140R1104	110354			0.240	5	
		13	DS201 M C13 A30	2CSR275140R1134	110453			0.240	5	
		16	DS201 M C16 A30	2CSR275140R1164	110552			0.240	5	
		20	DS201 M C20 A30	2CSR275140R1204	110651			0.240	5	
		25	DS201 M C25 A30	2CSR275140R1254	110750			0.240	5	
		32	DS201 M C32 A30	2CSR275140R1324	110859			0.240	5	
	100	40	40	DS201 M C40 A30	2CSR275140R1404	110958			0.240	5
			6	DS201 M C6 A100	2CSR275140R2064	111856			0.240	5
		10	DS201 M C10 A100	2CSR275140R2104	111955			0.240	5	
		16	DS201 M C16 A100	2CSR275140R2164	112051			0.240	5	
		20	DS201 M C20 A100	2CSR275140R2204	112150			0.240	5	
		25	DS201 M C25 A100	2CSR275140R2254	112259			0.240	5	
300	32	32	DS201 M C32 A100	2CSR275140R2324	112358			0.240	5	
		40	DS201 M C40 A100	2CSR275140R2404	112457			0.240	5	
	6	6	DS201 M C6 A300	2CSR275140R3064	113355			0.240	5	
		10	DS201 M C10 A300	2CSR275140R3104	113454			0.240	5	
		13	DS201 M C13 A300	2CSR275140R3134	113553			0.240	5	
		16	DS201 M C16 A300	2CSR275140R3164	113652			0.240	5	
		20	DS201 M C20 A300	2CSR275140R3204	113751			0.240	5	
		25	DS201 M C25 A300	2CSR275140R3254	113850			0.240	5	
32	DS201 M C32 A300	2CSR275140R3324	113959			0.240	5			
40	DS201 M C40 A300	2CSR275140R3404	114055			0.240	5			

3

TECHNICAL CHARACTERISTICS

	Standards			
Electrical features	Type (wave form of the earth leakage sensed)			
	Poles			
	Rated current I_n		A	
	Rated sensitivity $I_{\Delta n}$		A	
	Rated voltage U_e		V	
	Insulation voltage U_i		V	
	Max. operating voltage of circuit test		V	
	Min. operating voltage of circuit test		V	
	Rated frequency		Hz	
	Rated breaking capacity acc. to IEC/EN 61009	ultimate I_{cn}		A
	Rated breaking capacity acc. to IEC/EN 60947-2	ultimate I_{cu}		kA
	2P @230 VAC	service I_{cs}		kA
	Rated residual breaking capacity $I_{\Delta m}$			kA
	Rated impulse withstand voltage (1.2/50) U_{imp}			kV
	Dielectric test voltage at ind. freq. for 1 min.			kV
	Thermomagnetic release characteristic	B: $3 I_n \leq I_m \leq 5 I_n$ C: $5 I_n \leq I_m \leq 10 I_n$ K: $10 I_n \leq I_m \leq 14 I_n$		
Surge current resistance (wave 8/20)			A	
Mechanical features	Toggle			
	Flag indicators			
	Electrical life			
	Mechanical life			
	Protection degree	housing terminals		
	Tropicalization acc. to IEC /EN 60068-2	constant climatic conditions variable climatic conditions		°C/RH °C/RH
	Reference temperature for setting of thermal element			°C
	Ambient temperature (with daily average $\leq +35$ °C)			°C
	Storage temperature			°C
	Installation	Terminal type	top bottom	
Terminal size top/bottom for cables			mm ²	
Terminal size top/bottom for busbar			mm ²	
Tightening torque top/bottom			N*m	
Mounting Connection				
Dimensions and weight	Dimensions (H x D x W)		mm	
	Weight		g	
Combination with auxiliary elements	Combinable with:	auxiliary contact signal contact shunt trip undervoltage release		

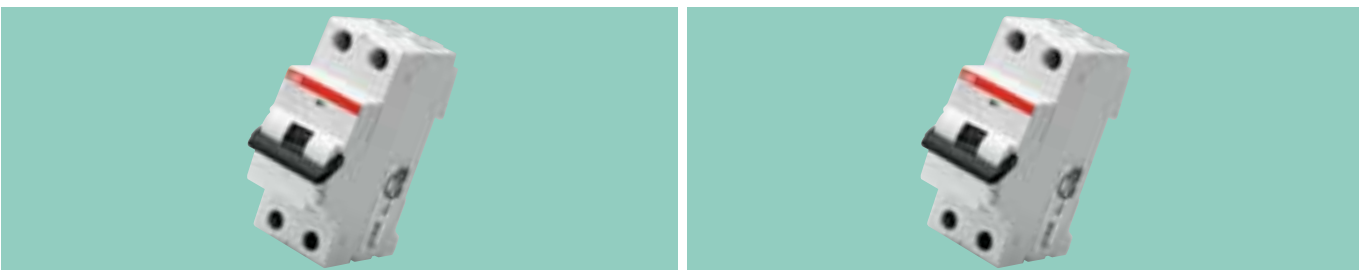

DS202C	IEC / EN 61009	DS202C M
A	A	APR
	2P	
	$6 \leq I_n \leq 32$	
0.03-0.3		0.01-0.03-0.3
	230-240	
	500	
	254	
	110	
	50...60	
6000		10000
10		10
6		7.5
6		6
	4	
	2.5	
■		■
■		■
	250 (3000 for APR versions)	
	black sealable in ON-OFF position	
	differential trip indicator (blue)	
	contact position indicator (green/red)	
	10000	
	20000	
	IP4X	
	IP2X	
	23/83 - 40/93 - 55/20	
	25/95 - 40/95	
	30	
	-25...+55	
	-40...+70	
	failsafe bi-directional cylinder-lift terminal at top and bottom (shock protected)	
	failsafe bi-directional cylinder-lift terminal at top and bottom (shock protected)	
	25/25	
	10/10	
	2.8	
	on DIN rail EN 60715 (35 mm) by means of fast clip device	
	from top and bottom	
	85 x 69 x 35	
	239	
	yes	
	yes	
	yes	
	yes	

B

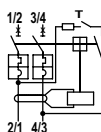

DS202C A type, B characteristic

Function: protection of end user single-phase circuits against overload and short-circuit currents; protection against the effects of sinusoidal alternating and direct pulsating earth fault currents; protection against indirect contact and additional protection against direct contact ($I_{\Delta n}=30$ mA).

Application: residential, commercial, industrial.

Standard: IEC/EN 61009

$I_{cn}=6$ kA

Number of poles	Rated residual current $I_{\Delta n}$ mA	Rated current In A	Order details Type code	Order code	Bbn 8012542 EAN	Price 1 piece	Price group	Weight 1 piece kg	Pack unit pc.	
2	30	6	DS202C B6 A30	2CSR252140R1065	132257			0.240	5	
		10	DS202C B10 A30	2CSR252140R1105	132356		0.240	5		
		13	DS202C B13 A30	2CSR252140R1135	132455		0.240	5		
		16	DS202C B16 A30	2CSR252140R1165	132554		0.240	5		
		20	DS202C B20 A30	2CSR252140R1205	132653		0.240	5		
		25	DS202C B25 A30	2CSR252140R1255	132752		0.240	5		
		32	DS202C B32 A30	2CSR252140R1325	132851		0.240	5		
		300	6	6	DS202C B6 A300	2CSR252140R3065	132950		0.240	5
				10	DS202C B10 A300	2CSR252140R3105	133056		0.240	5
				13	DS202C B13 A300	2CSR252140R3135	133155		0.240	5
16	DS202C B16 A300			2CSR252140R3165	133254		0.240	5		
20	DS202C B20 A300			2CSR252140R3205	133353		0.240	5		
25	DS202C B25 A300			2CSR252140R3255	133452		0.240	5		
32	DS202C B32 A300			2CSR252140R3325	133551		0.240	5		

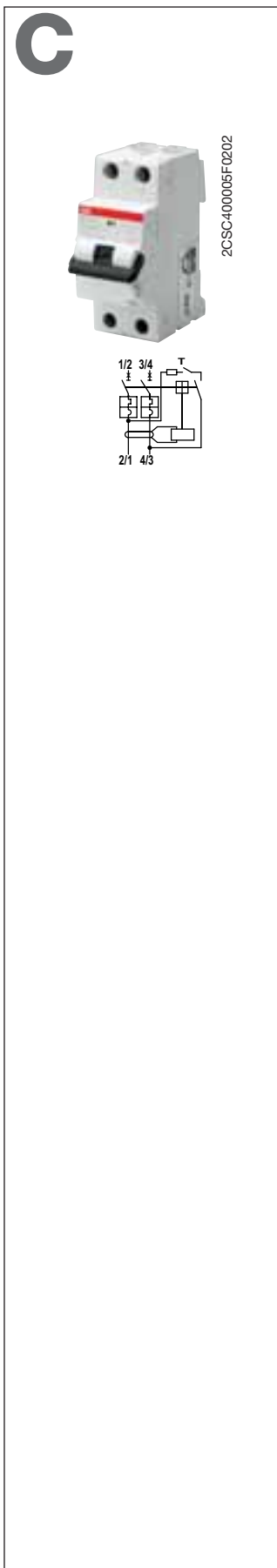

DS202C A type, C characteristic

Function: protection of end user single-phase circuits against overload and short-circuit currents; protection against the effects of sinusoidal alternating and direct pulsating earth fault currents; protection against indirect contact and additional protection against direct contact ($I_{\Delta n}=30$ mA).

Application: residential, commercial, industrial.

Standard: IEC/EN 61009

Icn=6 kA

Number of poles	Rated residual current $I_{\Delta n}$ mA	Rated current In A	Order details		Bbn 8012542	Price 1 piece	Price group	Weight 1 piece kg	Pack unit pc.
			Type code	Order code					
2	30	6	DS202C C6 A30	2CSR252140R1064	122357			0.240	5
		10	DS202C C10 A30	2CSR252140R1104	122456			0.240	5
		13	DS202C C13 A30	2CSR252140R1134	122555			0.240	5
		16	DS202C C16 A30	2CSR252140R1164	122654			0.240	5
		20	DS202C C20 A30	2CSR252140R1204	122753			0.240	5
		25	DS202C C25 A30	2CSR252140R1254	122852			0.240	5
	32	DS202C C32 A30	2CSR252140R1324	122951			0.240	5	
	300	6	DS202C C6 A300	2CSR252140R3064	123057			0.240	5
		10	DS202C C10 A300	2CSR252140R3104	123156			0.240	5
		13	DS202C C13 A300	2CSR252140R3134	123255			0.240	5
		16	DS202C C16 A300	2CSR252140R3164	123354			0.240	5
		20	DS202C C20 A300	2CSR252140R3204	123453			0.240	5
25		DS202C C25 A300	2CSR252140R3254	123552			0.240	5	
		32	DS202C C32 A300	2CSR252140R3324	123651			0.240	5

B



2CSC400005F0202

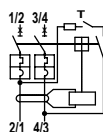

DS202C M A type, B characteristic

Function: protection of end user single-phase circuits against overload and short-circuit currents; protection against the effects of sinusoidal alternating and direct pulsating earth fault currents; protection against indirect contact and additional protection against direct contact ($I_{\Delta n}=30$ mA).

Application: residential, commercial, industrial.

Standard: IEC/EN 61009

$I_{cn}=10$ kA

Number of poles	Rated residual current $I_{\Delta n}$ mA	Rated current In A	Order details		Bbn 8012542	Price 1 piece	Price group	Weight 1 piece kg	Pack unit pc.	
			Type code	Order code						EAN
1+N	10	10	DS202C M B10 A10	2CSR272140R0105	124856			0.240	5	
		13	DS202C M B13 A10	2CSR272140R0135	117759			0.240	5	
		16	DS202C M B16 A10	2CSR272140R0165	117858			0.240	5	
	30	6	6	DS202C M B6 A30	2CSR272140R1065	118152			0.240	5
			10	DS202C M B10 A30	2CSR272140R1105	118251			0.240	5
			13	DS202C M B13 A30	2CSR272140R1135	118350			0.240	5
			16	DS202C M B16 A30	2CSR272140R1165	118459			0.240	5
			20	DS202C M B20 A30	2CSR272140R1205	118558			0.240	5
			25	DS202C M B25 A30	2CSR272140R1255	118657			0.240	5
300	6	32	DS202C M B32 A30	2CSR272140R1325	118756			0.240	5	
		6	DS202C M B6 A300	2CSR272140R3065	119555			0.240	5	
		10	DS202C M B10 A300	2CSR272140R3105	119654			0.240	5	
		13	DS202C M B13 A300	2CSR272140R3135	119753			0.240	5	
		16	DS202C M B16 A300	2CSR272140R3165	119852			0.240	5	
		20	DS202C M B20 A300	2CSR272140R3205	119951			0.240	5	
		25	DS202C M B25 A300	2CSR272140R3255	120056			0.240	5	
		32	DS202C M B32 A300	2CSR272140R3325	120155			0.240	5	

C



2CSC400005F0202

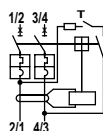

DS202C M A type, C characteristic

Function: protection of end user single-phase circuits against overload and short-circuit currents; protection against the effects of sinusoidal alternating earth fault currents; protection against indirect contact and additional protection against direct contact ($I_{\Delta n}=30$ mA).

Application: residential, commercial, industrial.

Standard: IEC/EN 61009

$I_{cn}=10$ kA

Number of poles	Rated residual current $I_{\Delta n}$ mA	Rated current In A	Order details		Bbn 8012542	Price 1 piece	Price group	Weight 1 piece kg	Pack unit pc.
			Type code	Order code					
1+N	10	13	DS202C M C13 A10	2CSR272140R0134	117957			0.240	5
		16	DS202C M C16 A10	2CSR272140R0164	118053			0.240	5
30	6	6	DS202C M C6 A30	2CSR272140R1064	118855			0.240	5
		10	DS202C M C10 A30	2CSR272140R1104	118954			0.240	5
		13	DS202C M C13 A30	2CSR272140R1134	119050			0.240	5
		16	DS202C M C16 A30	2CSR272140R1164	119159			0.240	5
		20	DS202C M C20 A30	2CSR272140R1204	119258			0.240	5
		25	DS202C M C25 A30	2CSR272140R1254	119357			0.240	5
300	6	32	DS202C M C32 A30	2CSR272140R1324	119456			0.240	5
		6	DS202C M C6 A300	2CSR272140R3064	120254			0.240	5
		10	DS202C M C10 A300	2CSR272140R3104	120353			0.240	5
		13	DS202C M C13 A300	2CSR272140R3134	120452			0.240	5
		16	DS202C M C16 A300	2CSR272140R3164	120551			0.240	5
		20	DS202C M C20 A300	2CSR272140R3204	120650			0.240	5
		25	DS202C M C25 A300	2CSR272140R3254	120759			0.240	5
		32	DS202C M C32 A300	2CSR272140R3324	120858			0.240	5

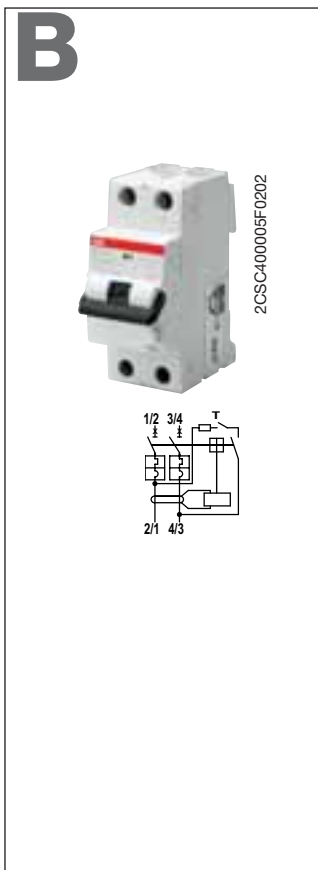

DS202C M APR type, B characteristic

Function: protection of end user single-phase circuits against overload and short-circuit currents; protection against the effects of sinusoidal alternating and direct pulsating earth fault currents; protection against indirect contact and additional protection against direct contact (I_{Δn}=30 mA).

Application: residential, commercial, industrial.

Standard: IEC/EN 61009

I_{cn}=10 kA

Number of poles	Rated residual current I _{Δn} mA	Rated current In A	Order details		Bbn 8012542	Price 1 piece	Price group	Weight 1 piece kg	Pack unit pc.
			Type code	Order code					
2	30	6	DS202C M B6 APR30	2CSR272440R1065	120957			0.240	5
		10	DS202C M B10 APR30	2CSR272440R1105	121053			0.240	5
		13	DS202C M B13 APR30	2CSR272440R1135	121152			0.240	5
		16	DS202C M B16 APR30	2CSR272440R1165	121251			0.240	5
		20	DS202C M B20 APR30	2CSR272440R1205	121350			0.240	5
		25	DS202C M B25 APR30	2CSR272440R1255	121459			0.240	5
	300	32	DS202C M B32 APR30	2CSR272440R1325	121558			0.240	5
		6	DS202C M B6 APR300	2CSR272440R3065	124955			0.240	5
		10	DS202C M B10 APR300	2CSR272440R3105	125051			0.240	5
		13	DS202C M B13 APR300	2CSR272440R3135	125150			0.240	5
		16	DS202C M B16 APR300	2CSR272440R3165	125259			0.240	5
		20	DS202C M B20 APR300	2CSR272440R3205	125358			0.240	5
		25	DS202C M B25 APR300	2CSR272440R3255	125457			0.240	5
		32	DS202C M B32 APR300	2CSR272440R3325	125556			0.240	5

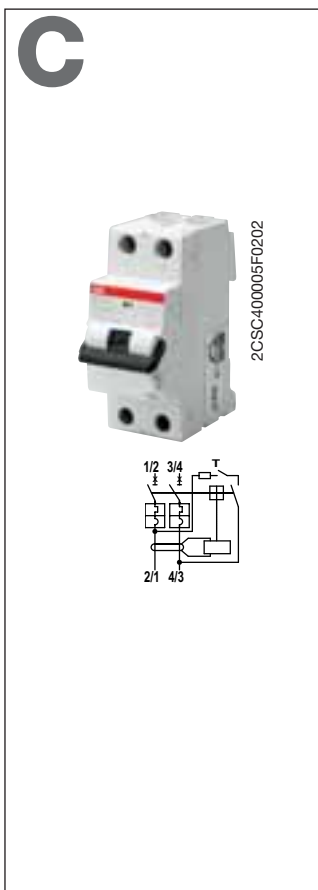

DS202C M APR type, C characteristic

Function: protection of end user single-phase circuits against overload and short-circuit currents; protection against the effects of sinusoidal alternating and direct pulsating earth fault currents; protection against indirect contact and additional protection against direct contact (I_{Δn}=30 mA).

Application: residential, commercial, industrial.

Standard: IEC/EN 61009

I_{cn}=10 kA

Number of poles	Rated residual current I _{Δn} mA	Rated current In A	Order details		Bbn 8012542	Price 1 piece	Price group	Weight 1 piece kg	Pack unit pc.
			Type code	Order code					
2	30	6	DS202C M C6 APR30	2CSR272440R1064	121657			0.240	5
		10	DS202C M C10 APR30	2CSR272440R1104	121756			0.240	5
		13	DS202C M C13 APR30	2CSR272440R1134	121855			0.240	5
		16	DS202C M C16 APR30	2CSR272440R1164	121954			0.240	5
		20	DS202C M C20 APR30	2CSR272440R1204	122050			0.240	5
		25	DS202C M C25 APR30	2CSR272440R1254	122159			0.240	5
		32	DS202C M C32 APR30	2CSR272440R1324	122258			0.240	5

3

TECHNICAL CHARACTERISTICS				
Standards				
Electrical features	Operating characteristic: type (wave form of the earth leakage sensed)			
	Poles			
	Rated sensitivity $I\Delta n$		A	
	Rated current I_n		A	
	Rated voltage U_e	2P, 3P, 4P	V	
	Rated residual operating current			
	Insulation voltage U_i		V	
	Max. operating voltage of circuit test			
	Min. operating voltage of circuit test			
	Rated frequency		Hz	
	Rated breaking capacity acc. to IEC/EN 61009	ultimate I_{cn}	A	
	Rated breaking capacity acc. to IEC/EN 60947-2 1P+N @230 VAC, 2P, 3P, 4P @400 VAC	ultimate I_{cu} service I_{cs}	kA kA	
	Rated residual breaking capacity $I_{\Delta m}$		kA	
	Rated impulse withstand voltage (1.2/50) U_{imp}		kV	
	Dielectric test voltage at ind. freq. for 1 min.		kV	
	Overvoltage category			
	Thermomagnetic release characteristic	B: $3 I_n \leq I_m \leq 5 I_n$ C: $5 I_n \leq I_m \leq 10 I_n$ K: $10 I_n \leq I_m \leq 14 I_n$		
Surge current resistance (wave 8/20)				
Mechanical features	Toggle	2P, 3P, 4P	A	
	Electrical life			
	Mechanical life			
	Protection degree	housing terminals		
	Tropicalization acc. to IEC /EN 60068-2	humid heat constant climatic conditions variable climatic conditions	°C/RH °C/RH °C/RH	
	Reference temperature for setting of thermal element			
	Ambient temperature (with daily average $\leq +35$ °C)			
	Storage temperature			
	Installation	Terminal type	top bottom 2P 3P/4P $I_n \leq 40$ A 3P/4P 50 A $\leq I_n \leq 63$ A	
		Terminal size top/bottom per cable	2P 3P/4P $I_n \leq 40$ A 3P/4P 50 A $\leq I_n \leq 63$ A	mm ² mm ² mm ²
Tightening torque top/bottom		2P 3P/4P $I_n \leq 40$ A 3P/4P 50 A $\leq I_n \leq 63$ A	N*m N*m N*m	
Mounting				
Connection				
Dimensions and weight		Dimensions (H x D x W)	2P 3P $I_n \leq 40$ A 4P $I_n \leq 40$ A 3P 50 A $\leq I_n \leq 63$ A 4P 50 A $\leq I_n \leq 63$ A	mm mm mm mm mm
		Weight	2P 3P $I_n \leq 40$ A 4P $I_n \leq 40$ A 3P 50 A $\leq I_n \leq 63$ A 4P 50 A $\leq I_n \leq 63$ A	g g g g g
	Combination with auxiliary elements	Combinable with:		
		auxiliary contact		
		signal contact/auxiliary switch		
		shunt trip undervoltage release		

① Available depending on type and characteristic curve. For 2P RCBOs A type B-C curves up to 32 A, refer to DS202C 2 protected poles RCBOs in only two modules

② Prior to connection of aluminium conductors (≥ 4 mm²) ensure that their contact points are cleaned, brushed and coated with grease



DS 200 AC	DS 200 A	DS 200 M AC	DS 200 M A
IEC/EN 61009, IEC/EN 60947-2			
AC	A	AC	A
2P, 3P, 4P			
0.03			
6 ≤ In ≤ 63 ①			
230-240			
230/400 - 240/415			
0.03			
500			
254 (440 for 3P and 4P)			
110 (195 for 3P and 4P)			
50...60			
6000	6000	10000	10000
10	10	15	15
7.5	7.5	11.2	11.2
6	6	10	10
6			
2.5			
III, disconnector abilities			
■			
■			
■			
250			
black (MCB) sealable in ON-OFF position + blue (RCD)			
10000			
20000			
IP4X			
IP2X			
28 cycles with 55/95...100			
23/83 - 40/93 - 55/20			
25/95 - 40/95			
30			
-25...+55			
-25...+55			
failsafe bidirectional cylinder-lift terminal (shock protected) ②			
failsafe bidirectional cylinder-lift terminal (shock protected) ②			
cage (shock protected)			
failsafe bidirectional cylinder-lift terminal (shock protected) ②			
(rigid and flexible) up to 25/25			
(rigid and flexible) up to 25/16			
(rigid and flexible) up to 25/25			
2.8/2.8			
2.8/1.2			
2.8/2.8			
on DIN rail EN 60715 (35 mm) by means of fast clip device			
715 (35 mm) by means of fast clip device from top and bottom			
85 x 69 x 70			
85 x 69 x 87.5			
85 x 69 x 105			
85 x 69 x 122.5			
85 x 69 x 140			
475			
625			
775			
775			
925			
yes			
yes			
yes			
yes			

B

DS 200 AC type, B characteristic

Function: protection against overload and short-circuit currents; protection against the effects of sinusoidal alternating earth fault currents; protection against indirect contacts and additional protection against direct contacts.

Application: commercial, industrial.

Standard: IEC/EN 61009 and IEC/EN 60947-2

Icn=6 kA

3



2CSC400191F0201

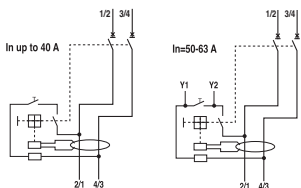

2CSC400193F0201

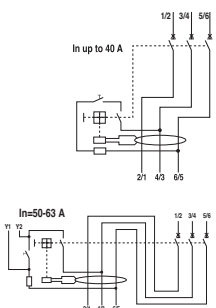

2CSC400194F0201

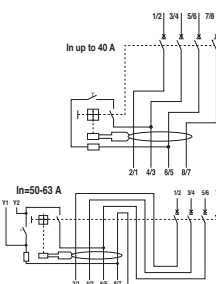

Number of poles	Type/class	Rated residual current IΔn mA	Rated current In A	Order details		Bbn 8012542	Price 1 piece	Price group	Weight 1 piece kg	Pack unit pc.
				Type code	Order code					
2	AC	30	6	DS202 AC-B6/0.03	2CSR252001R1065	863502			0.440	1
				DS202 AC-B10/0.03	2CSR252001R1105	863601		0.440	1	
				DS202 AC-B13/0.03	2CSR252001R1135	863700		0.440	1	
				DS202 AC-B16/0.03	2CSR252001R1165	863809		0.440	1	
				DS202 AC-B20/0.03	2CSR252001R1205	863908		0.440	1	
				DS202 AC-B25/0.03	2CSR252001R1255	864004		0.440	1	
				DS202 AC-B32/0.03	2CSR252001R1325	864103		0.440	1	
				DS202 AC-B40/0.03	2CSR252001R1405	864202		0.440	1	
				DS202 AC-B50/0.03	2CSR252001R1505	864301		0.440	1	
				DS202 AC-B63/0.03	2CSR252001R1635	864400		0.440	1	

3	AC	30	6	DS203 AC-B6/0.03	2CSR253001R1065	865506			0.610	1
				DS203 AC-B10/0.03	2CSR253001R1105	865605		0.610	1	
				DS203 AC-B13/0.03	2CSR253001R1135	865704		0.610	1	
				DS203 AC-B16/0.03	2CSR253001R1165	865803		0.610	1	
				DS203 AC-B20/0.03	2CSR253001R1205	865902		0.610	1	
				DS203 AC-B25/0.03	2CSR253001R1255	866008		0.610	1	
				DS203 AC-B32/0.03	2CSR253001R1325	866107		0.610	1	
				DS203 AC-B40/0.03	2CSR253001R1405	866206		0.610	1	
				DS203 AC-B50/0.03	2CSR253001R1505	866305		0.650	1	
				DS203 AC-B63/0.03	2CSR253001R1635	866404		0.650	1	

4	AC	30	6	DS204 AC-B6/0.03	2CSR254001R1065	867500			0.780	1
				DS204 AC-B10/0.03	2CSR254001R1105	867609		0.780	1	
				DS204 AC-B13/0.03	2CSR254001R1135	867708		0.780	1	
				DS204 AC-B16/0.03	2CSR254001R1165	867807		0.780	1	
				DS204 AC-B20/0.03	2CSR254001R1205	867906		0.780	1	
				DS204 AC-B25/0.03	2CSR254001R1255	868002		0.780	1	
				DS204 AC-B32/0.03	2CSR254001R1325	868101		0.780	1	
				DS204 AC-B40/0.03	2CSR254001R1405	868200		0.780	1	
				DS204 AC-B50/0.03	2CSR254001R1505	868309		0.825	1	
				DS204 AC-B63/0.03	2CSR254001R1635	868408		0.825	1	

① provided with additional terminals for remote tripping

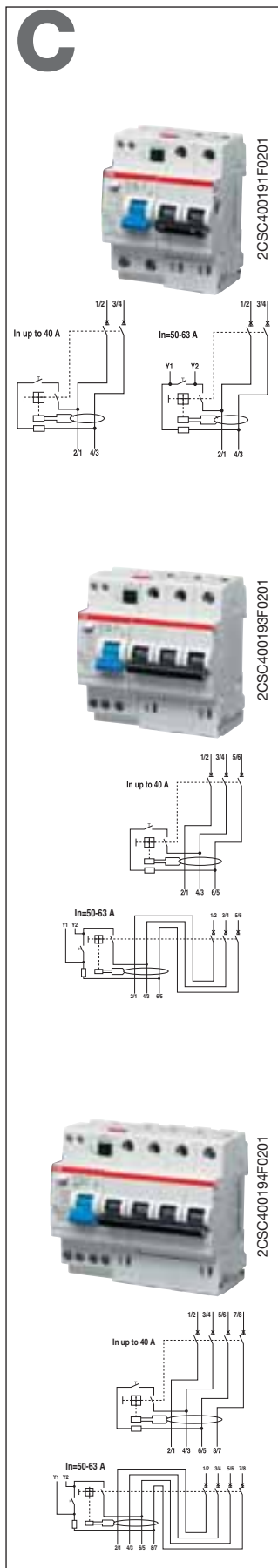

DS 200 AC type, C characteristic

Function: protection against overload and short-circuit currents; protection against the effects of sinusoidal alternating earth fault currents; protection against indirect contacts and additional protection against direct contacts.

Application: commercial, industrial.

Standard: IEC/EN 61009 and IEC/EN 60947-2

Icn=6 kA

Number of poles	Type/class	Rated residual current IΔn mA	Rated current In A	Order details Type code	Order code	Bbn 8012542	Price 1 piece	Price group	Weight 1 piece kg	Pack unit pc.
2	AC	30	6	DS202 AC-C6/0.03	2CSR252001R1064	869504			0.440	1
			10	DS202 AC-C10/0.03	2CSR252001R1104	869603			0.440	1
			13	DS202 AC-C13/0.03	2CSR252001R1134	869702			0.440	1
			16	DS202 AC-C16/0.03	2CSR252001R1164	869801			0.440	1
			20	DS202 AC-C20/0.03	2CSR252001R1204	869900			0.440	1
			25	DS202 AC-C25/0.03	2CSR252001R1254	870005			0.440	1
			32	DS202 AC-C32/0.03	2CSR252001R1324	870104			0.440	1
			40	DS202 AC-C40/0.03	2CSR252001R1404	870203			0.440	1
			50 ①	DS202 AC-C50/0.03	2CSR252001R1504	870302			0.440	1
			63 ①	DS202 AC-C63/0.03	2CSR252001R1634	870401			0.440	1

3	AC	30	6	DS203 AC-C6/0.03	2CSR253001R1064	871507			0.610	1
			10	DS203 AC-C10/0.03	2CSR253001R1104	871606			0.610	1
			13	DS203 AC-C13/0.03	2CSR253001R1134	871705			0.610	1
			16	DS203 AC-C16/0.03	2CSR253001R1164	871804			0.610	1
			20	DS203 AC-C20/0.03	2CSR253001R1204	871903			0.610	1
			25	DS203 AC-C25/0.03	2CSR253001R1254	872009			0.610	1
			32	DS203 AC-C32/0.03	2CSR253001R1324	872108			0.610	1
			40	DS203 AC-C40/0.03	2CSR253001R1404	872207			0.610	1
			50 ①	DS203 AC-C50/0.03	2CSR253001R1504	872306			0.650	1
			63 ①	DS203 AC-C63/0.03	2CSR253001R1634	872405			0.650	1

4	AC	30	6	DS204 AC-C6/0.03	2CSR254001R1064	873501			0.780	1
			10	DS204 AC-C10/0.03	2CSR254001R1104	873600			0.780	1
			13	DS204 AC-C13/0.03	2CSR254001R1134	873709			0.780	1
			16	DS204 AC-C16/0.03	2CSR254001R1164	873808			0.780	1
			20	DS204 AC-C20/0.03	2CSR254001R1204	873907			0.780	1
			25	DS204 AC-C25/0.03	2CSR254001R1254	874003			0.780	1
			32	DS204 AC-C32/0.03	2CSR254001R1324	874102			0.780	1
			40	DS204 AC-C40/0.03	2CSR254001R1404	874201			0.780	1
			50 ①	DS204 AC-C50/0.03	2CSR254001R1504	874300			0.825	1
			63 ①	DS204 AC-C63/0.03	2CSR254001R1634	874409			0.825	1

① provided with additional terminals for remote tripping

B

DS 200 A type, B characteristic

Function: protection against overload and short-circuit currents; protection against the effects of sinusoidal alternating and direct pulsating earth fault currents; protection against indirect contacts and additional protection against direct contacts.

Application: commercial, industrial.

Standard: IEC/EN 61009 and IEC/EN 60947-2

Icn=6 kA

3

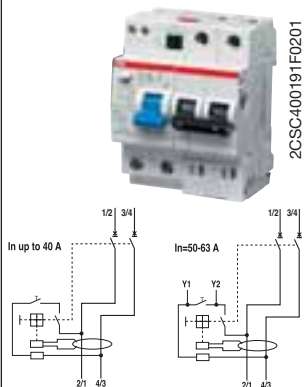

2CSC400191F0201

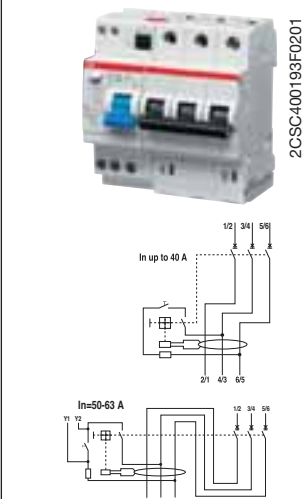

2CSC400193F0201

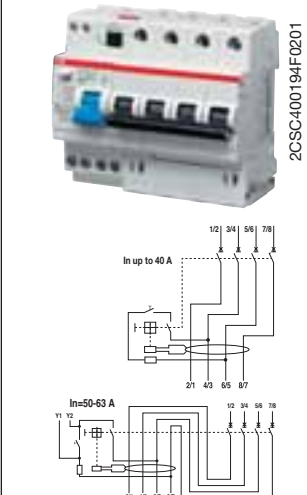

2CSC400194F0201

Number of poles	Type/class	Rated residual current IΔn mA	Rated current In A	Order details		Bbn 8012542	Price 1 piece	Price group	Weight 1 piece	Pack unit
				Type code	Order code					
2	A	30	40	DS202 A-B40/0.03	2CSR252101R1405	858201			0.440	1
				50 ①	2CSR252101R1505	858300		0.440	1	
				63 ①	2CSR252101R1635	858409		0.440	1	
3	A	30	6	DS203 A-B6/0.03	2CSR253101R1065	858508			0.610	1
				10	2CSR253101R1105	858607		0.610	1	
				13	2CSR253101R1135	858706		0.610	1	
				16	2CSR253101R1165	858805		0.610	1	
				20	2CSR253101R1205	858904		0.610	1	
				25	2CSR253101R1255	859000		0.610	1	
				32	2CSR253101R1325	859109		0.610	1	
				40	2CSR253101R1405	859208		0.610	1	
				50 ①	2CSR253101R1505	859307		0.650	1	
63 ①	2CSR253101R1635	859406		0.650	1					
4	A	30	6	DS204 A-B6/0.03	2CSR254101R1065	859505			0.780	1
				10	2CSR254101R1105	859604		0.780	1	
				13	2CSR254101R1135	859703		0.780	1	
				16	2CSR254101R1165	859802		0.780	1	
				20	2CSR254101R1205	859901		0.780	1	
				25	2CSR254101R1255	860006		0.780	1	
				32	2CSR254101R1325	860105		0.780	1	
				40	2CSR254101R1405	860204		0.780	1	
				50 ①	2CSR254101R1505	860303		0.825	1	
63 ①	2CSR254101R1635	860402		0.825	1					

① provided with additional terminals for remote tripping

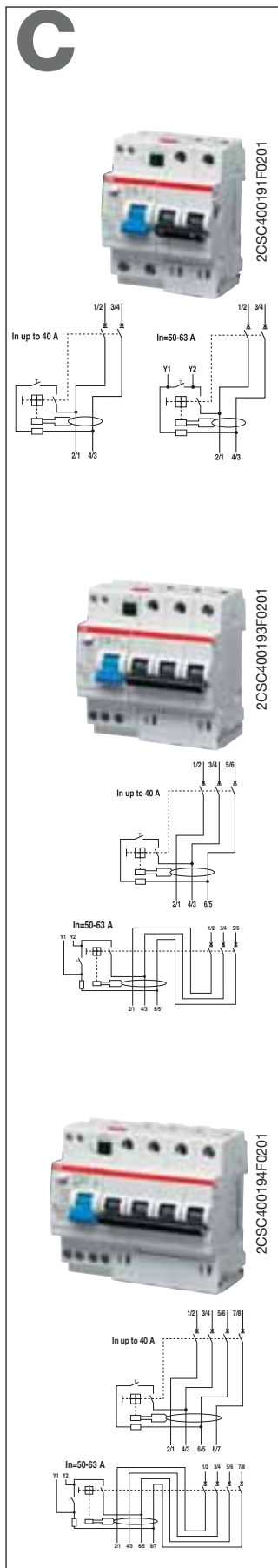

DS 200 A type, C characteristic

Function: protection against overload and short-circuit currents; protection against the effects of sinusoidal alternating and direct pulsating earth fault currents; protection against indirect contacts and additional protection against direct contacts.

Application: commercial, industrial.

Standard: IEC/EN 61009 and IEC/EN 60947-2

Icn=6 kA

Number of poles	Type/class	Rated residual current IΔn mA	Rated current In A	Order details Type code	Order code	Bbn 8012542	Price 1 piece	Price group	Weight 1 piece kg	Pack unit pc.
2	A	30	40	DS202 A-C40/0.03	2CSR252101R1404	861201			0.440	1
			50 ①	DS202 A-C50/0.03	2CSR252101R1504	861300		0.440	1	
			63 ①	DS202 A-C63/0.03	2CSR252101R1634	861409		0.440	1	
3	A	30	6	DS203 A-C6/0.03	2CSR253101R1064	861508			0.610	1
			10	DS203 A-C10/0.03	2CSR253101R1104	861607		0.610	1	
			13	DS203 A-C13/0.03	2CSR253101R1134	861706		0.610	1	
			16	DS203 A-C16/0.03	2CSR253101R1164	861805		0.610	1	
			20	DS203 A-C20/0.03	2CSR253101R1204	861904		0.610	1	
			25	DS203 A-C25/0.03	2CSR253101R1254	862000		0.610	1	
			32	DS203 A-C32/0.03	2CSR253101R1324	862109		0.610	1	
			40	DS203 A-C40/0.03	2CSR253101R1404	862208		0.610	1	
			50 ①	DS203 A-C50/0.03	2CSR253101R1504	862307		0.650	1	
63 ①	DS203 A-C63/0.03	2CSR253101R1634	862406		0.650	1				
4	A	30	6	DS204 A-C6/0.03	2CSR254101R1064	862505			0.780	1
			10	DS204 A-C10/0.03	2CSR254101R1104	862604		0.780	1	
			13	DS204 A-C13/0.03	2CSR254101R1134	862703		0.780	1	
			16	DS204 A-C16/0.03	2CSR254101R1164	862802		0.780	1	
			20	DS204 A-C20/0.03	2CSR254101R1204	862901		0.780	1	
			25	DS204 A-C25/0.03	2CSR254101R1254	863007		0.780	1	
			32	DS204 A-C32/0.03	2CSR254101R1324	863106		0.780	1	
			40	DS204 A-C40/0.03	2CSR254101R1404	863205		0.780	1	
			50 ①	DS204 A-C50/0.03	2CSR254101R1504	863304		0.825	1	
63 ①	DS204 A-C63/0.03	2CSR254101R1634	863403		0.825	1				

① provided with additional terminals for remote tripping

C

DS 200 A type, K characteristic

Function: protection and control against overloads and short-circuit in systems where motors, transformers and auxiliary circuits are present. Advantages: no unwanted release in case of currents peak up to 8 x In, according to the series; thanks to the high sensibility bimetal, the K curve switches offer protection of the sensible elements from overcurrents; they also allow the best protection of cables and lines.

Application: commercial, industrial.

Standard: IEC/EN 60947-2

Icn=6 kA

3

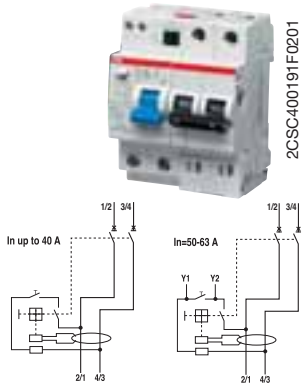

Number of poles	Type/class	Rated residual current IΔn mA	Rated current In A	Order details		Bbn 8012542	Price 1 piece	Price group	Weight 1 piece	Pack unit
				Type code	Order code					
2	A	30	6	DS202 A-K6/0.03	2CSR252101R1067	930303			0.475	1
				DS202 A-K10/0.03	2CSR252101R1107	900702		0.475	1	
				DS202 A-K13/0.03	2CSR252101R1137	930402		0.475	1	
				DS202 A-K16/0.03	2CSR252101R1167	930501		0.475	1	
				DS202 A-K20/0.03	2CSR252101R1207	930600		0.475	1	
				DS202 A-K25/0.03	2CSR252101R1257	930709		0.475	1	
				DS202 A-K32/0.03	2CSR252101R1327	930808		0.475	1	
				DS202 A-K40/0.03	2CSR252101R1407	930907		0.475	1	
				DS202 A-K50/0.03	2CSR252101R1507	931003		0.475	1	
				DS202 A-K63/0.03	2CSR252101R1637	931102		0.475	1	

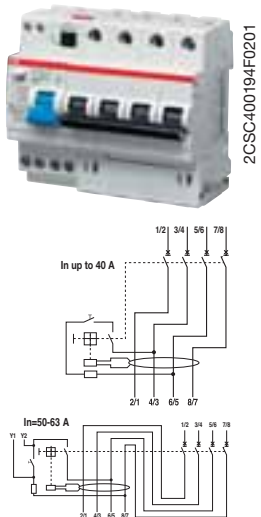

4	A	30	6	DS204 A-K6/0.03	2CSR254101R1067	931201			0.775	1
				DS204 A-K10/0.03	2CSR254101R1107	931300		0.775	1	
				DS204 A-K13/0.03	2CSR254101R1137	931409		0.775	1	
				DS204 A-K16/0.03	2CSR254101R1167	931508		0.775	1	
				DS204 A-K20/0.03	2CSR254101R1207	931607		0.775	1	
				DS204 A-K25/0.03	2CSR254101R1257	931706		0.775	1	
				DS204 A-K32/0.03	2CSR254101R1327	931805		0.775	1	
				DS204 A-K40/0.03	2CSR254101R1407	931904		0.775	1	
				DS204 A-K50/0.03	2CSR254101R1507	932000		0.775	1	
				DS204 A-K63/0.03	2CSR254101R1637	932109		0.775	1	

① provided with additional terminals for remote tripping

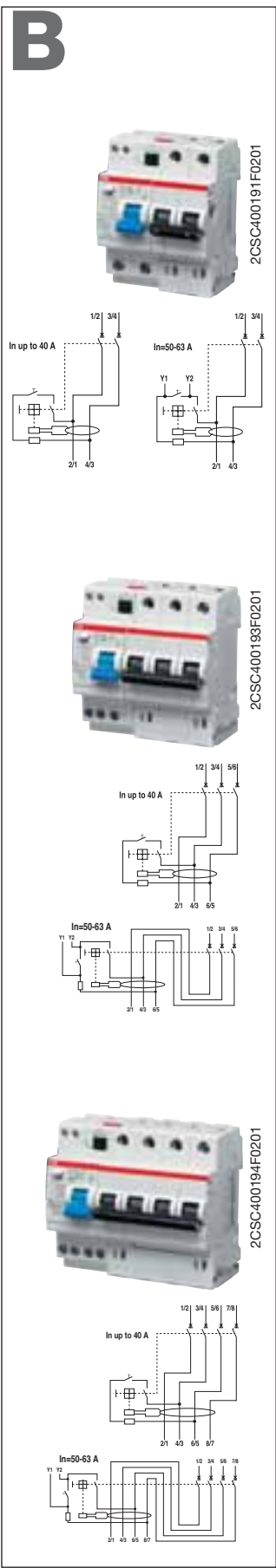

DS 200 M AC type, B characteristic

Function: protection against overload and short-circuit currents; protection against the effects of sinusoidal alternating earth fault currents; protection against indirect contacts and additional protection against direct contacts.

Application: commercial, industrial.

Standard: IEC/EN 61009

Icn=10 kA

Number of poles	Type/class	Rated residual current IΔn mA	Rated current In A	Order details Type code	Order code	Bbn 8012542	Price 1 piece	Price group	Weight 1 piece kg	Pack unit pc.
2	AC	30	6	DS202 M AC-B6/0.03	2CSR272001R1065	932208			0.440	1
			10	DS202 M AC-B10/0.03	2CSR272001R1105	932307			0.440	1
			13	DS202 M AC-B13/0.03	2CSR272001R1135	932406			0.440	1
			16	DS202 M AC-B16/0.03	2CSR272001R1165	932505			0.440	1
			20	DS202 M AC-B20/0.03	2CSR272001R1205	932604			0.440	1
			25	DS202 M AC-B25/0.03	2CSR272001R1255	932703			0.440	1
			32	DS202 M AC-B32/0.03	2CSR272001R1325	932802			0.440	1
			40	DS202 M AC-B40/0.03	2CSR272001R1405	932901			0.440	1
			50 ①	DS202 M AC-B50/0.03	2CSR272001R1505	933007			0.440	1
			63 ①	DS202 M AC-B63/0.03	2CSR272001R1635	933106			0.440	1

3	AC	30	6	DS203 M AC-B6/0.03	2CSR273001R1065	933205			0.610	1
			10	DS203 M AC-B10/0.03	2CSR273001R1105	933304			0.610	1
			13	DS203 M AC-B13/0.03	2CSR273001R1135	933403			0.610	1
			16	DS203 M AC-B16/0.03	2CSR273001R1165	933502			0.610	1
			20	DS203 M AC-B20/0.03	2CSR273001R1205	933601			0.610	1
			25	DS203 M AC-B25/0.03	2CSR273001R1255	933700			0.610	1
			32	DS203 M AC-B32/0.03	2CSR273001R1325	933809			0.610	1
			40	DS203 M AC-B40/0.03	2CSR273001R1405	933908			0.610	1
			50 ①	DS203 M AC-B50/0.03	2CSR273001R1505	934004			0.650	1
			63 ①	DS203 M AC-B63/0.03	2CSR273001R1635	934103			0.650	1

4	AC	30	6	DS204 M AC-B6/0.03	2CSR274001R1065	934202			0.780	1
			10	DS204 M AC-B10/0.03	2CSR274001R1105	934301			0.780	1
			13	DS204 M AC-B13/0.03	2CSR274001R1135	934400			0.780	1
			16	DS204 M AC-B16/0.03	2CSR274001R1165	934509			0.780	1
			20	DS204 M AC-B20/0.03	2CSR274001R1205	934608			0.780	1
			25	DS204 M AC-B25/0.03	2CSR274001R1255	934707			0.780	1
			32	DS204 M AC-B32/0.03	2CSR274001R1325	934806			0.780	1
			40	DS204 M AC-B40/0.03	2CSR274001R1405	934905			0.780	1
			50 ①	DS204 M AC-B50/0.03	2CSR274001R1505	935001			0.825	1
			63 ①	DS204 M AC-B63/0.03	2CSR274001R1635	935100			0.825	1

① provided with additional terminals for remote tripping

C

DS 200 M AC type, C characteristic

Function: protection against overload and short-circuit currents; protection against the effects of sinusoidal alternating earth fault currents; protection against indirect contacts and additional protection against direct contacts.

Application: commercial, industrial.

Standard: IEC/EN 61009

Icn=10 kA

3

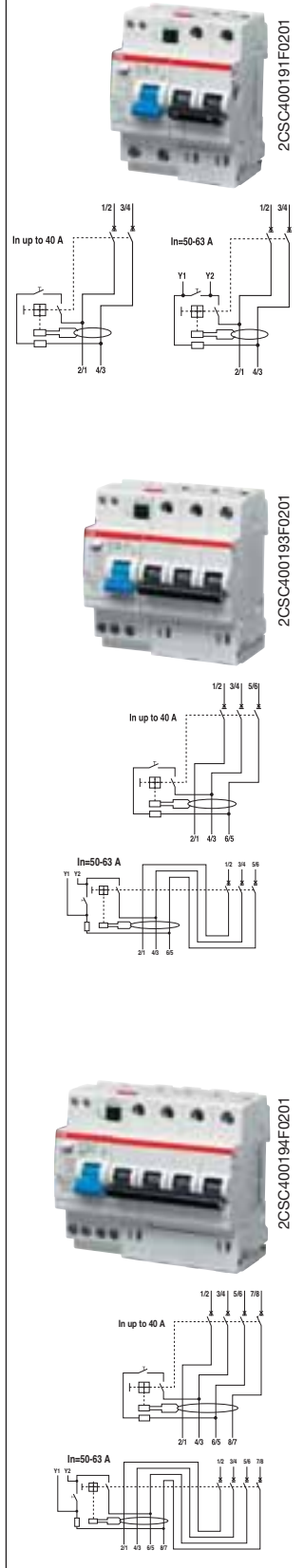

Number of poles	Type/class	Rated residual current I Δ n mA	Rated current In A	Order details	Bbn 8012542	Price 1 piece	Price group	Weight 1 piece kg	Pack unit pc.
				Type code	Order code				
2	AC	30	6	DS202 M AC-C6/0.03	2CSR272001R1064	851509		0.440	1
				DS202 M AC-C10/0.03	2CSR272001R1104	851608		0.440	1
				DS202 M AC-C13/0.03	2CSR272001R1134	851707		0.440	1
				DS202 M AC-C16/0.03	2CSR272001R1164	851806		0.440	1
				DS202 M AC-C20/0.03	2CSR272001R1204	851905		0.440	1
				DS202 M AC-C25/0.03	2CSR272001R1254	852001		0.440	1
				DS202 M AC-C32/0.03	2CSR272001R1324	852100		0.440	1
				DS202 M AC-C40/0.03	2CSR272001R1404	852209		0.440	1
				DS202 M AC-C50/0.03	2CSR272001R1504	852308		0.440	1
				DS202 M AC-C63/0.03	2CSR272001R1634	852407		0.440	1

3	AC	30	6	DS203 M AC-C6/0.03	2CSR273001R1064	852506		0.610	1
				DS203 M AC-C10/0.03	2CSR273001R1104	852605		0.610	1
				DS203 M AC-C13/0.03	2CSR273001R1134	852704		0.610	1
				DS203 M AC-C16/0.03	2CSR273001R1164	852803		0.610	1
				DS203 M AC-C20/0.03	2CSR273001R1204	852902		0.610	1
				DS203 M AC-C25/0.03	2CSR273001R1254	853008		0.610	1
				DS203 M AC-C32/0.03	2CSR273001R1324	853107		0.610	1
				DS203 M AC-C40/0.03	2CSR273001R1404	853206		0.610	1
				DS203 M AC-C50/0.03	2CSR273001R1504	853305		0.650	1
				DS203 M AC-C63/0.03	2CSR273001R1634	853404		0.650	1

4	AC	30	6	DS204 M AC-C6/0.03	2CSR274001R1064	853503		0.780	1
				DS204 M AC-C10/0.03	2CSR274001R1104	853602		0.780	1
				DS204 M AC-C13/0.03	2CSR274001R1134	853701		0.780	1
				DS204 M AC-C16/0.03	2CSR274001R1164	853800		0.780	1
				DS204 M AC-C20/0.03	2CSR274001R1204	853909		0.780	1
				DS204 M AC-C25/0.03	2CSR274001R1254	854005		0.780	1
				DS204 M AC-C32/0.03	2CSR274001R1324	854104		0.780	1
				DS204 M AC-C40/0.03	2CSR274001R1404	854203		0.780	1
				DS204 M AC-C50/0.03	2CSR274001R1504	854302		0.825	1
				DS204 M AC-C63/0.03	2CSR274001R1634	854401		0.825	1

① provided with additional terminals for remote tripping

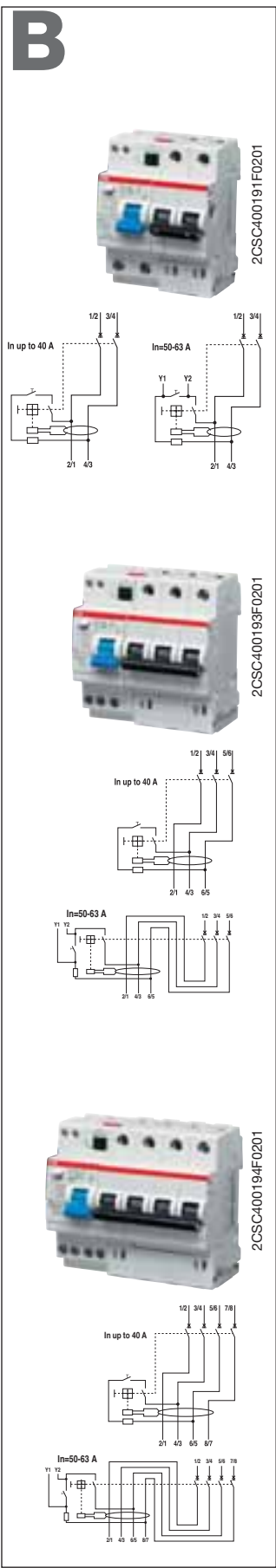

DS 200 M A type, B characteristic

Function: protection against overload and short-circuit currents; protection against the effects of sinusoidal alternating and direct pulsating earth fault currents; protection against indirect contacts and additional protection against direct contacts.

Application: commercial, industrial.

Standard: IEC/EN 61009

Icn=10 kA

Number of poles	Type/class	Rated residual current $I_{\Delta n}$ mA	Rated current In A	Order details		Bbn 8012542	Price 1 piece	Price group	Weight 1 piece kg	Pack unit pc.
				Type code	Order code					
2	A	30	40	DS202 M A-B40/0.03	2CSR272101R1405	846208			0.440	1
			50 ①	DS202 M A-B50/0.03	2CSR272101R1505	846307			0.440	1
			63 ①	DS202 M A-B63/0.03	2CSR272101R1635	846406			0.440	1
3	A	30	6	DS203 M A-B6/0.03	2CSR273101R1065	846505			0.610	1
			10	DS203 M A-B10/0.03	2CSR273101R1105	846604			0.610	1
			13	DS203 M A-B13/0.03	2CSR273101R1135	846703			0.610	1
			16	DS203 M A-B16/0.03	2CSR273101R1165	846802			0.610	1
			20	DS203 M A-B20/0.03	2CSR273101R1205	846901			0.610	1
			25	DS203 M A-B25/0.03	2CSR273101R1255	847007			0.610	1
			32	DS203 M A-B32/0.03	2CSR273101R1325	847106			0.610	1
			40	DS203 M A-B40/0.03	2CSR273101R1405	847205			0.610	1
			50 ①	DS203 M A-B50/0.03	2CSR273101R1505	847304			0.650	1
			63 ①	DS203 M A-B63/0.03	2CSR273101R1635	847403			0.650	1
4	A	30	6	DS204 M A-B6/0.03	2CSR274101R1065	847502			0.780	1
			10	DS204 M A-B10/0.03	2CSR274101R1105	847601			0.780	1
			13	DS204 M A-B13/0.03	2CSR274101R1135	847700			0.780	1
			16	DS204 M A-B16/0.03	2CSR274101R1165	847809			0.780	1
			20	DS204 M A-B20/0.03	2CSR274101R1205	847908			0.780	1
			25	DS204 M A-B25/0.03	2CSR274101R1255	848004			0.780	1
			32	DS204 M A-B32/0.03	2CSR274101R1325	848103			0.780	1
			40	DS204 M A-B40/0.03	2CSR274101R1405	848202			0.780	1
			50 ①	DS204 M A-B50/0.03	2CSR274101R1505	848301			0.825	1
			63 ①	DS204 M A-B63/0.03	2CSR274101R1635	848400			0.825	1

① provided with additional terminals for remote tripping

C

DS 200 M A type, C characteristic

Function: protection against overload and short-circuit currents; protection against the effects of sinusoidal alternating and direct pulsating earth fault currents; protection against indirect contacts and additional protection against direct contacts.

Application: commercial, industrial.

Standard: IEC/EN 61009

Icn=10 kA



2CSC400191F0201

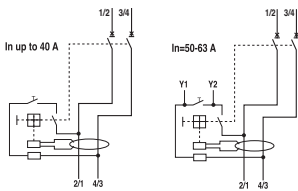

2CSC400193F0201

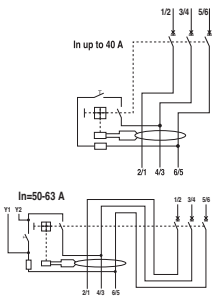

Number of poles	Type/class	Rated residual current I Δ n mA	Rated current In A	Order details		Bbn 8012542	Price 1 piece	Price group	Weight 1 piece	Pack unit
				Type code	Order code					
						EAN			kg	pc.
2	A	30	40	DS202 M A-C40/0.03	2CSR272101R1404	849209			0.440	1
				50 ①	DS202 M A-C50/0.03	2CSR272101R1504	849308		0.440	1
				63 ①	DS202 M A-C63/0.03	2CSR272101R1634	849407		0.440	1
3	A	30	6	DS203 M A-C6/0.03	2CSR273101R1064	849506			0.610	1
				10	DS203 M A-C10/0.03	2CSR273101R1104	849605		0.610	1
				13	DS203 M A-C13/0.03	2CSR273101R1134	849704		0.610	1
				16	DS203 M A-C16/0.03	2CSR273101R1164	849803		0.610	1
				20	DS203 M A-C20/0.03	2CSR273101R1204	849902		0.610	1
				25	DS203 M A-C25/0.03	2CSR273101R1254	850007		0.610	1
				32	DS203 M A-C32/0.03	2CSR273101R1324	850106		0.610	1
				40	DS203 M A-C40/0.03	2CSR273101R1404	850205		0.610	1
				50 ①	DS203 M A-C50/0.03	2CSR273101R1504	850304		0.650	1
63 ①	DS203 M A-C63/0.03	2CSR273101R1634	850403		0.650	1				

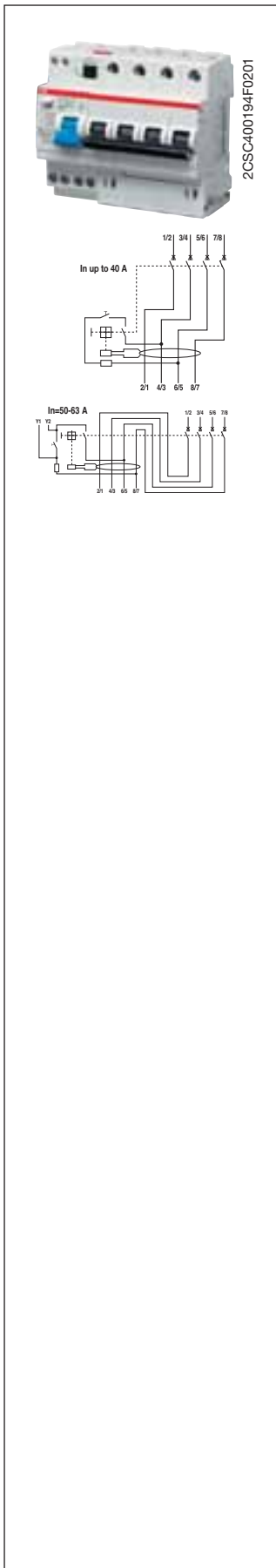

4	A	30	6	DS204 M A-C6/0.03	2CSR274101R1064	850502	0.780	1
			10	DS204 M A-C10/0.03	2CSR274101R1104	850601	0.780	1
			13	DS204 M A-C13/0.03	2CSR274101R1134	850700	0.780	1
			16	DS204 M A-C16/0.03	2CSR274101R1164	850809	0.780	1
			20	DS204 M A-C20/0.03	2CSR274101R1204	850908	0.780	1
			25	DS204 M A-C25/0.03	2CSR274101R1254	851004	0.780	1
			32	DS204 M A-C32/0.03	2CSR274101R1324	851103	0.780	1
			40	DS204 M A-C40/0.03	2CSR274101R1404	851202	0.780	1
			50 ①	DS204 M A-C50/0.03	2CSR274101R1504	851301	0.825	1
			63 ①	DS204 M A-C63/0.03	2CSR274101R1634	851400	0.825	1

① provided with additional terminals for remote tripping

The range of DDA 60, 70 and selective 90 RCD blocks for the S 290 series includes 100A devices suitable for assembly with MCBs in the S 290 series of type C only.

The DDA 800 RCD blocks for protecting people and electrical installations are useful when a higher breaking capacity is required. Assembling a DDA 800 RCD block with an S 800 N or S 800 S MCB creates an RCBO with a breaking capacity of 36 kA and 50 kA respectively. The RCD-blocks must be mounted on the right side of the MCB, so that the available accessories can be mounted on the left side. DDA 800 RCD blocks are available in AC and A, A AP-R (high immunity) and A selective types. DS 800 RCBOs are available, only in the size of 125 A, in A, AP-R (high immunity) and A selective types.

In compliance with IEC EN 61009, which establishes that the RCD blocks can be assembled with an MCB only once, the S 290 series DDA blocks have a mechanical pin which prevents disassembly once inserted.

In contrast, RCD blocks for the S 800 series which conform to IEC EN 60947-2 app. B do not have unlosable coupling elements.

DDA RCD blocks for the S 290 and S 800 series are

not sensitive to impulsive atmospheric and operational discharges, therefore, they are not subject to unwanted tripping in accordance with IEC EN 61008, and IEC EN 61009, even with 8/20 μ s wave up to 250 A.



2CSC400170F0201

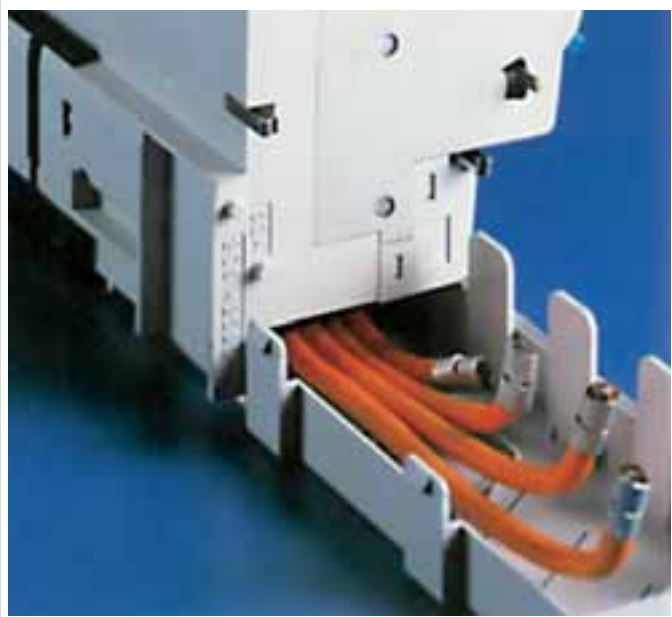

2CSC400273F0201

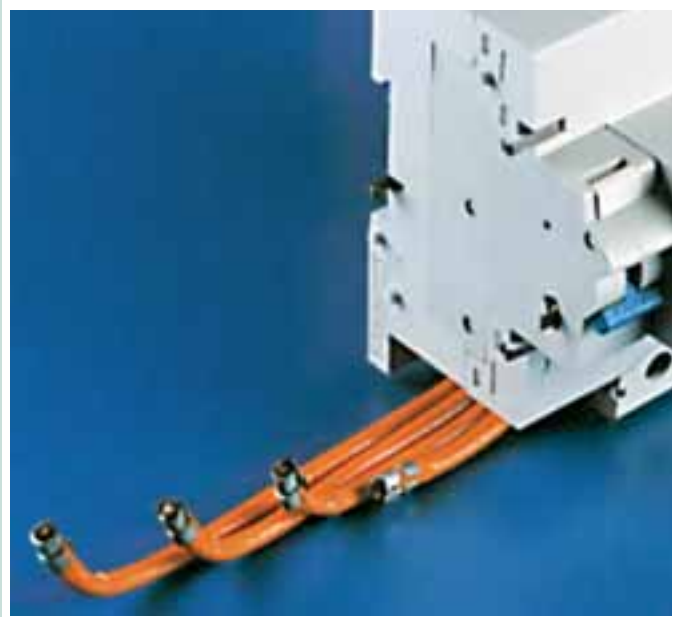

2CSC400274F0201



Residual current devices DDA for S 290 and S800 series, RCBOs DS800 and 1P+N RCBOs DS271, RD2, RD3, RD residual current relays and TR toroidal transformers

Index

Technical features of RCDs-blocks for MCBs S 290 series	3/62
Selection tables of RCDs-blocks for MCBs S 290 series DDA 60, DDA 70 and DDA 90 for MCBs S 290 series	3/64
Technical features of RCDs-blocks for MCBs S800 series	3/66
Selection tables of RCD-blocks for MCBs S800 series DDA 800 for MCBs S800 series	3/68
Technical features of DS800 RCBOs series	3/72
Selection tables of DS800 RCBOs series DS800 RCBOs series	3/74
Technical features of 1P+N RCBOs DS271 series	3/80
Selection tables of 1P+N RCBOs DS271 series DS271 RCBOs series	3/82
Selection tables of residual current relays RD2, RD3, RD and toroidal transformers TR RD2 residual current relays	3/84
RD3 residual current relays	3/85
RD front panel residual current relays	3/86
TR toroidal transformers.....	3/87

3

TECHNICAL FEATURES			
	Standards		
Electrical features	Type (wave form of the earth leakage sensed)		
	Poles		
	Rated current I _n		A
	Rated sensitivity I _{Δn}		A
	Rated voltage U _N		V
	Insulation voltage U _i		V
	Max. operating voltage of circuit test		V
	Min. operating voltage of circuit test		V
	Rated frequency		Hz
	Rated breaking capacity (I _{cn}) acc. to IEC /EN 61009		A
	Rated breaking capacity (I _{cn}) acc. to IEC/EN 60947-2		A
	Rated residual breaking capacity I _{Δm}		kA
	Rated impulse withstand voltage (1.2/50) U _{imp}		kV
	Dielectric test voltage at ind. freq. for 1 min.		kV
	Surge current resistance (wave 8/20)		A
Mechanical features	Toggle		
	Electrical life		
	Mechanical life		
	Protection degree	housing terminals	
	Tropicalization acc. to IEC /EN 60068-2	humid heat	°C/RH
		constant climatic conditions	°C/RH
		variable climatic conditions	°C/RH
	Ambient temperature (with daily average ≤ +35 °C)		°C
	Storage temperature		°C
	Installation	Terminal size for cables	
Tightening torque			N*m
Mounting			
Dimensions and weight	Dimensions (H x D x W)	2P	mm
		3P/4P	mm
	Weight	2P	g
		3P/4P	g
Combination with auxiliary elements	Combinable with:	S 290 C characteristic	
		S 290 D and K characteristics	



DDA 60	DDA 70	DDA 90
	IEC/EN 61009 Ann. G	
AC	A	A - A selective
	2P, 4P	
	100	
0.03-0.3	0.03-0.3	0.3-1
	230/400	
	500	
	240(2P), 415(4P)	
	100(2P), 175(4P)	
	50...60	
	according to the breaking capacity of the associated MCB	
	according to the breaking capacity of the associated MCB	
	7.5	
	4	
	2.5	
250	1000	3000
	black operating from ON-OFF position	
	10000	
	20000	
	IP4X	
	IP2X	
	28 cycles with 55/95...100	
	23/83 - 40/93 - 55/20	
	25/95 - 40/95	
	-25...+45	
	-40...+60	
	50	
	3.5	
	on DIN rail EN 60715 (35 mm) by means of rapid fixing device	
	94 x 68 x 61	
	94 x 68 x 90	
	325	
	600	
	yes	
	no	

AC



2CSC400167F0201

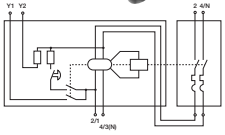

2CSC400169F0201

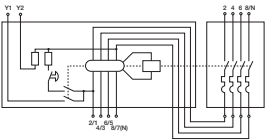

DDA 60 AC type for MCBs S 290

Function: RCD-block for assembly on site with MCBs S 290 series only in C characteristic. Protection against the effects of sinusoidal alternating earth fault currents; protection against indirect contacts and additional protection against direct (with $I\Delta n=30$ mA) contacts.

Additional terminals for remote tripping are available.

Application: commercial, industrial.

Standard: IEC/EN 61009 Ann. G

Number of poles	Rated residual current	Rated current	Order details		Bbn 4016779	Price 1 piece	Price group	Weight 1 piece	Pack unit
	$I\Delta n$ mA	In A	Type code	Order code	EAN			kg	pc.
2	0.03	100	DDA62 100 30MA	36229002	183307			0.325	1
	0.3	100	DDA62 100 300MA	36229010	183505			0.325	1
4	0.03	100	DDA 64 100 30MA	36229044	183901			0.600	1
	0.3	100	DDA 64 100 300MA	36229051	184106			0.600	1

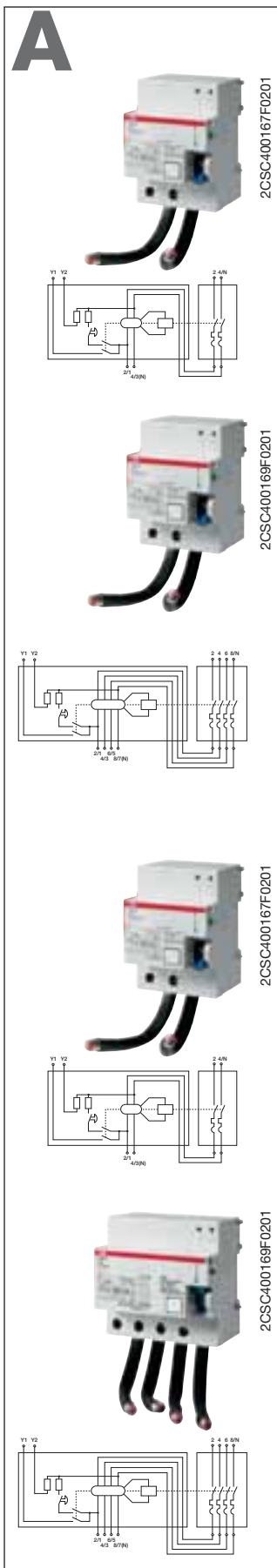

DDA 70 A type for MCBs S 290

Function: RCD-block for assembly on site with MCBs S 290 series only in C characteristic. Protection against the effects of sinusoidal alternating and direct pulsating earth fault currents; protection against indirect contacts and additional protection against direct (with $I\Delta n=30\text{ mA}$) contacts. Additional terminals for remote tripping are available.

Application: commercial, industrial.

Standard: IEC/EN 61009 Ann. G

Number of poles	Rated residual current $I\Delta n\text{ mA}$	Rated current $I_n\text{ A}$	Order details Type code	Order code	Bbn 4016779 EAN	Price 1 piece	Price group	Weight 1 piece kg	Pack unit pc.
2	0.03	100	DDA 72 100 30MA	36229069	184304			0.325	1
	0.3	100	DDA 72 100 300MA	36229077	184403			0.325	1

4	0.03	100	DDA 74 100 30MA	36229101	184700			0.600	1
	0.3	100	DDA 74 100 300MA	36229119	184809			0.600	1

DDA 90 A selective type for MCBs S 290

Function: RCD-block for assembly on site with MCBs S 290 series (only in C characteristic). Protection against the effects of sinusoidal alternating and direct pulsating earth fault currents with an intentional tripping delay, which permits to realize the selectivity with downstream instantaneous devices (for more information about selectivity see the technical guide). Additional terminals for remote tripping are available.

Application: commercial, industrial.

Standard: IEC/EN 61009 Ann. G

2	0.3	100	DDA 92 100 300MA S	36229127	185103			0.325	1
	1	100	DDA 92 100 1A S	36229135	185509			0.325	1

4	0.3	100	DDA 94 100 300MA S	36229168	185905			0.600	1
	1	100	DDA 94 100 1A S	36229176	186001			0.600	1

3

TECHNICAL FEATURES

	Standards		
Electrical features	Type (wave form of the earth leakage sensed)		
	Poles		
	Rated current I _n		A
	Rated sensitivity I _{Δn}		A
	Rated voltage U _e		V
	Insulation voltage U _i		V
	Max. operating voltage of circuit test		V
	Min. operating voltage of circuit test		V
	Rated frequency		Hz
	Rated breaking capacity (I _{cn}) acc. to IEC /EN 60947-2		A
	Rated residual breaking capacity I _{Δm}	with S 800 N	kA
		with S 800 S	kA
	Rated impulse withstand voltage (1.2/50) U _{imp}		kV
Dielectric test voltage at ind. freq. for 1 min.		kV	
Surge current resistance (wave 8/20)		A	
Mechanical features	Toggle		
	Electrical life		
	Mechanical life		
	Protection degree	housing terminals	
	Tropicalization acc. to IEC /EN 60068-2	humid heat constant climatic conditions variable climatic conditions	°C/RH °C/RH °C/RH
	Ambient temperature (with daily average ≤ +35 °C)		°C
	Storage temperature		°C
	Terminal size for cables	flexible rigid	mm ² mm ²
	Tightening torque		N*m
	Mounting		
Dimensions and weight	Dimensions (H x D x W)	2P 3P 4P	mm mm mm
	Weight	2P	g
		3P	g
		4P	g
	Combination with MCBs	Combinable with:	S 800 N S 800 S



DDA 800 AC	DDA 800 A		DDA 800 A AP-R	DDA 800 A S	
IEC/EN 60947-2 Ann. B					
AC	A		A	A	
2P, 3P, 4P					
63	63	100	63-100	63	100
0.03-0.3	0.03-0.3-0.5	0.3-0.5	0.03	0.3-1	0.3-0.5*-1
230/400 - 240/415 - 400/690					
690					
690					
195					
50...60					
according to the breaking capacity of the associated MCB					
according to the Icu of the associated MCB					
according to the Icu of the associated MCB					
6					
2.5					
250			3000	5000	
blue operating just from OFF position					
10000					
20000					
IP4X					
IP2X					
28 cycles with 55/95...100					
23/83 - 40/93 - 55/20					
25/95 - 40/95					
-25...+60					
-40...+70					
6...50					
6...70					
min. 3 / max. 4					
on DIN rail EN 60715 (35 mm) by means of rapid fixing device					
108.2 x 82.3 x 81					
108.2 x 82.3 x 117					
108.2 x 82.3 x 117					
300 for 63 A - 415 for 100 A					
400 for 63 A - 640 for 100 A					
460 for 63 A - 765 for 100 A					
yes					
yes					

* only on 3P and 4P versions

AC



2CSC400177F0201

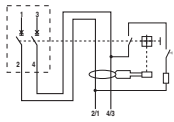

3



2CSC400178F0201

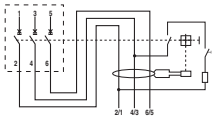

2CSC400179F0201

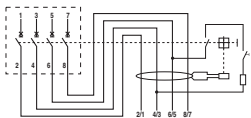

DDA 800 AC type for MCBs S800

Function: RCD-block for assembly on site with MCBs S800 series up to 63 A. Protection against the effects of sinusoidal alternating earth fault currents; protection against indirect contacts and additional protection against direct (with $I_{\Delta n}=30$ mA) contacts.

Application: commercial, industrial.

Standard: IEC/EN 60947-2 Ann. B

Number of poles	Rated residual current	Rated current	Order details	Bbn	Price 1 piece	Price group	Weight 1 piece	Pack unit
	$I_{\Delta n}$ mA	I_n A	Type code	Order code	EAN		kg	pc.
2	30	63	DDA802AC-63/0.03	2CSB802001R1630	919704		0.300	1
	300	63	DDA802AC-63/0.3	2CSB802001R3630	919902		0.300	1
3	30	63	DDA803AC-63/0.03	2CSB803001R1630	922001		0.400	1
	300	63	DDA803AC-63/0.3	2CSB803001R3630	922209		0.400	1
4	30	63	DDA804AC-63/0.03	2CSB804001R1630	924401		0.460	1
	300	63	DDA804AC-63/0.3	2CSB804001R3630	924609		0.460	1

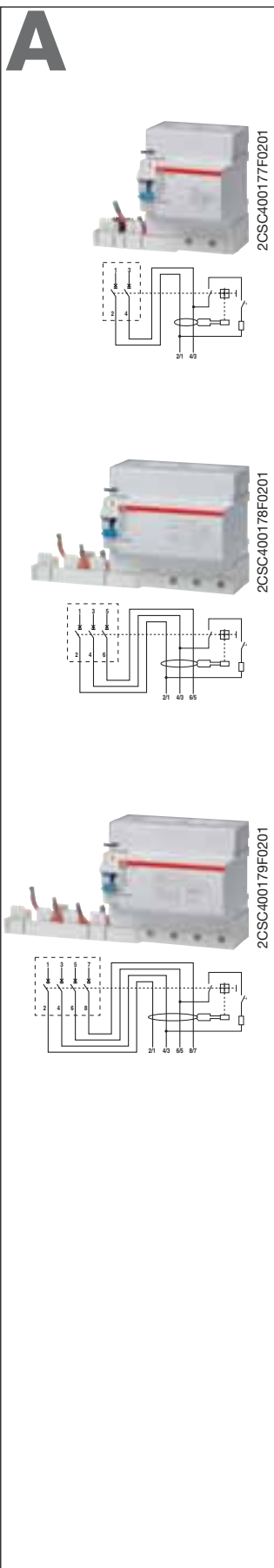

DDA 800 A type for MCBs S800

Function: RCD-block for assembly on site with MCBs S800 up to 100 A. Protection against the effects of sinusoidal alternating and direct pulsating earth fault currents; protection against indirect contacts and additional protection against direct (with $I_{\Delta n}=30$ mA) contacts.

Application: commercial, industrial.

Standard: IEC/EN 60947-2 Ann. B

Number of poles	Rated residual current $I_{\Delta n}$ mA	Rated current I_n A	Order details	Bbn 8012542	Price 1 piece	Price group	Weight 1 piece kg	Pack unit pc.
			Type code	Order code	EAN			
2	30	63	DDA802 A-63/0.03	2CSB802101R1630	920007		0.300	1
	300	63	DDA802 A-63/0.3	2CSB802101R3630	920205		0.300	1
		100	DDA802 A-100/0.3	2CSB802101R3000	545033		0.415	1
	500	63	DDA802 A-63/0.5	2CSB802101R4630	920403		0.300	1
		100	DDA802 A-100/0.5	2CSB802101R4000	542636		0.415	1
3	30	63	DDA803 A-63/0.03	2CSB803101R1630	922308		0.400	1
	300	63	DDA803 A-63/0.3	2CSB803101R3630	922506		0.400	1
		100	DDA803 A-100/0.3	2CSB803101R3000	544135		0.640	1
	500	63	DDA803 A-63/0.5	2CSB803101R4630	922704		0.400	1
		100	DDA803 A-100/0.5	2CSB803101R4000	541738		0.640	1
4	30	63	DDA804 A-63/0.03	2CSB804101R1630	924807		0.460	1
	300	63	DDA804 A-63/0.3	2CSB804101R3630	925002		0.460	1
		100	DDA804 A-100/0.3	2CSB804101R3000	547532		0.765	1
	500	63	DDA804 A-63/0.5	2CSB804101R4630	925200		0.460	1
		100	DDA804 A-100/0.5	2CSB804101R4000	544937		0.765	1

A



2CSC400177F0201

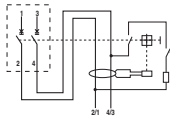

2CSC400178F0201

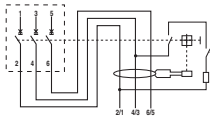

2CSC400179F0201

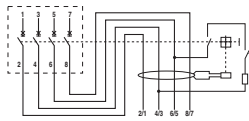

DDA 800 A AP-R type for MCBs S800

Function: RCD-block for assembly on site with MCBs S800 up to 100 A. Protection against the effects of sinusoidal alternating and direct pulsating earth fault currents, providing the best compromise between safety and continuity in the service thanks to the resistance to unwanted trippings; protection against indirect contacts and additional protection against direct (with $I_{\Delta n}=30$ mA) contacts.

Application: commercial, industrial.

Standard: IEC/EN 60947-2 Ann. B

Number of poles	Rated residual current $I_{\Delta n}$ mA	Rated current I_n A	Order details		Bbn 8012542	Price 1 piece	Price group	Weight 1 piece kg	Pack unit pc.
			Type code	Order code					
2	30	63	DDA802 A-63/0.03 AP-R	2CSB802401R1630	921400			0.300	1
		100	DDA802 A-100/0.03 AP-R	2CSB802401R1000	544630			0.415	1
3	30	63	DDA803 A-63/0.03 AP-R	2CSB803401R1630	923800			0.400	1
		100	DDA803 A-100/0.03 AP-R	2CSB803401R1000	542230			0.640	1
4	30	63	DDA804 A-63/0.03 AP-R	2CSB804401R1630	927709			0.460	1
		100	DDA804 A-100/0.03 AP-R	2CSB804401R1000	547136			0.765	1

3

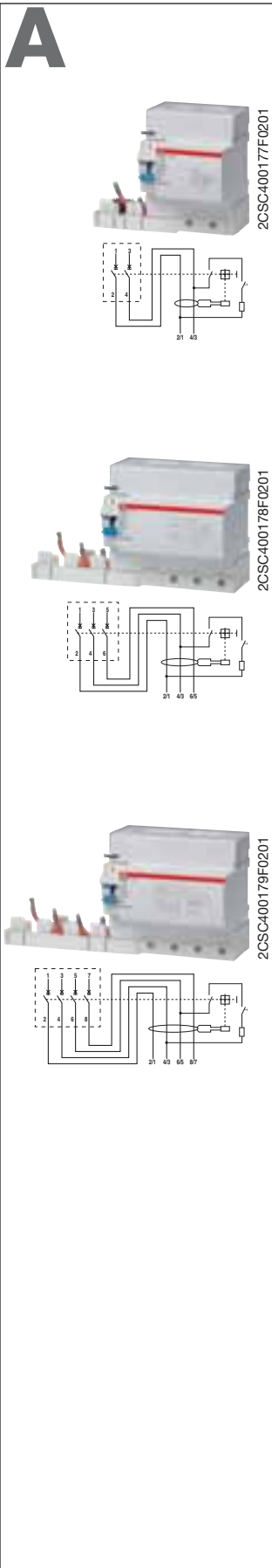

DDA 800 A selective type for MCBs S800

Function: RCD-block for assembly on site with MCBs S800 series up to 100 A. Protection against the effects of sinusoidal alternating and direct pulsating earth fault currents with an intentional tripping delay, which permits to realize the selectivity with downstream instantaneous devices (for more information about selectivity see the technical guide).

Application: commercial, industrial.

Standard: IEC/EN 60947-2 Ann. B

Number of poles	Rated residual current IΔn mA	Rated current In A	Order details		Bbn 8012542	Price 1 piece	Price group	Weight 1 piece kg	Pack unit pc.
			Type code	Order code					
2	300	63	DDA802 A S-63/0.3	2CSB802201R3630	920601			0.300	1
			DDA802 A S-100/0.3	2CSB802201R3000	542537		0.415		
	1000	63	DDA802 A S-63/1	2CSB802201R5630	920809			0.300	1
			DDA802 A S-100/1	2CSB802201R5000	547433		0.415	1	
3	300	63	DDA803 A S-63/0.3	2CSB803201R3630	922902			0.400	1
			DDA803 A S-100/0.3	2CSB803201R3000	544838		0.640	1	
	500	100	DDA803 A S-100/0.5	2CSB803201R4000	542438			0.640	1
			1000	63	DDA803 A S-63/1	2CSB803201R5630	923206		0.400
DDA803 A S-100/1	2CSB803201R5000	547334				0.640	1		
3	300	63	DDA804 A S-63/0.3	2CSB804201R3630	926207			0.460	1
			DDA804 A S-100/0.3	2CSB804201R3000	544739		0.765	1	
	500	100	DDA804 A S-100/0.5	2CSB804201R4000	542339			0.765	1
			1000	63	DDA804 A S-63/1	2CSB804201R5630	926504		0.460
DDA804 A S-100/1	2CSB804201R5000	547235				0.765	1		

3

TECHNICAL CHARACTERISTICS

Standards

Electrical features	Operating characteristic: type (wave form of the earth leakage sensed)		
	Poles		
	Rated sensitivity $I\Delta n$		A
	Rated current I_n		A
	Rated voltage U_e		V
	Insulation voltage U_i		V
	Max. operating voltage of circuit test		V
	Min. operating voltage of circuit test		V
	Rated frequency		Hz
	Short-circuit breaking capacity ultimate I_{cu}	240/415 V	kA
		254/440 V	kA
	acc. to IEC/EN 60947-2	289/500 V	kA
	(AC) 50/60 Hz	400/690 V	kA
	Short-circuit breaking capacity service I_{cs}	240/415 V	kA
		254/440 V	kA
	acc. to IEC/EN 60947-2	289/500 V	kA
	(AC) 50/60 Hz	400/690 V	kA
	Rated impulse withstand voltage (1.2/50) U_{imp}		kV
	Dielectric test voltage at ind. freq. for 1 min.		kV
	Thermomagnetic release characteristic	B: $3 I_n \leq I_m \leq 5 I_n$ C: $5 I_n \leq I_m \leq 10 I_n$ D: $10 I_n \leq I_m \leq 20 I_n$ K: $8 I_n \leq I_m \leq 14 I_n$	
Surge current resistance acc. to VDE 0432 Part 2 (wave 8/20)		A	
Mechanical features	Toggle		
	Electrical life		
	Mechanical life		
	Protection degree	housing terminals	
	Tropicalization acc. to IEC /EN 60068-2	humid heat constant climatic conditions variable climatic conditions	°C/RH °C/RH °C/RH
	Ambient temperature (with daily average $\leq + 35$ °C)		°C
	Storage temperature		°C
	Installation	Terminal size for cables	flexible rigid
Tightening torque			N*m
Mounting			
Dimensions and weight	Dimensions (H x D x W)	2P 3P 4P	mm mm mm
	Weight	2P	g
		3P	g
		4P	g
	Combination with auxiliary elements	Combinable with:	
auxiliary contact			
signal contact/auxiliary switch			
shunt trip undervoltage release			

(*) 1A on 2P and 4P versions, while 0.3A only on 4P ones.



DS800S A	DS800N A	DS800S A S	DS800N A S	DS800S A AP-R	DS800N A AP-R
IEC/EN 60947-2					
A		A		A	
2P, 3P, 4P		2P,4P		2P, 3P, 4P	
0.3		0.3-1(*)		0.03	
125					
230/400-240/415-400/690					
690					
690					
195					
50...60					
50	36	50	36	50	36
30	20	30	20	30	20
10	10	10	10	10	10
4.5	4.5	4.5	4.5	4.5	4.5
40	30	40	30	40	30
15	10	15	10	15	10
5	5	5	5	5	5
3	3	3	3	3	3
6					
2.5					
■ ■ ■ ■	■ ■ ■	■ ■ ■ ■	■ ■ ■	■ ■ ■ ■	■ ■ ■
250	250	5000	5000	3000	3000
black (MCB) sealable in ON-OFF position + blue (RCD) operating just from OFF position					
10000					
20000					
IP4X					
IP2X					
28 cycles with 55/95...100					
23/83 - 40/93 - 55/20					
25/95 - 40/95					
-25...+60					
-40...+70					
6...50					
6...70					
min. 3 / max. 4					
on DIN rail EN 60715 (35 mm) by means of rapid fixing device					
108,2 x 82,3 x 133.5					
108,2 x 82,3 x 196					
108,2 x 82,3 x 223					
790					
1140					
1440					
yes					
yes					
yes					
yes					

DS800S, A type

Function: protection against overload and short-circuit currents; protection against the effects of sinusoidal alternating earth fault currents; protection against indirect contacts; command and isolation of resistive and inductive loads.

Application: industrial.

Standard: IEC/EN 60947-2

Icu=50 kA



2CCA13257F0001

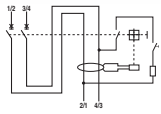

2CCA13258F0001

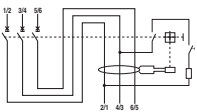

2CCA13259F0001

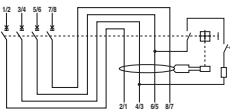

Number of poles	Curve	Rated residual current I Δ n mA	Rated current In A	Order details		Bbn 7612271	Price 1 piece	Price group	Weight 1 piece	Pack unit
				Type code	Order code					
2	B	300	125	DS802S-B125/0.3A	2CCA862005R0845	211721			0.790	1
	C	300	125	DS802S-C125/0.3A	2CCA862005R0844	211738			0.790	1
	D	300	125	DS802S-D125/0.3A	2CCA862005R0841	211745			0.790	1
	K	300	125	DS802S-K125/0.3A	2CCA862005R0647	211752			0.790	1
3	B	300	125	DS803S-B125/0.3A	2CCA863005R0845	211769			1.14	1
	C	300	125	DS803S-C125/0.3A	2CCA863005R0844	211776			1.14	1
	D	300	125	DS803S-D125/0.3A	2CCA863005R0841	211783			1.14	1
	K	300	125	DS803S-K125/0.3A	2CCA863005R0647	211790			1.14	1
4	B	300	125	DS804S-B125/0.3A	2CCA864005R0845	211806			1.44	1
	C	300	125	DS804S-C125/0.3A	2CCA864005R0844	211813			1.44	1
	D	300	125	DS804S-D125/0.3A	2CCA864005R0841	211820			1.44	1
	K	300	125	DS804S-K125/0.3A	2CCA864005R0647	211837			1.44	1

DS800N, A type

Function: protection against overload and short-circuit currents; protection against the effects of sinusoidal alternating earth fault currents; protection against indirect contacts; command and isolation of resistive and inductive loads.

Application: industrial.

Standard: IEC/EN 60947-2

Icu=36 kA

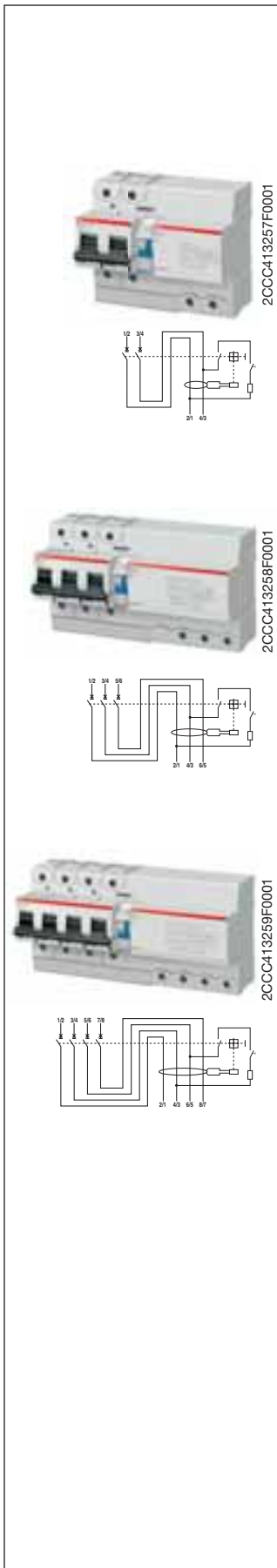

Number of poles	Curve	Rated residual current IΔn mA	Rated current In A	Order details Type code	Order code	Bbn 7612271	Price 1 piece	Price group	Weight 1 piece	Pack unit
2	B	300	125	DS802N-B125/0.3A	2CCA892005R0845	211844			0.790	1
	C	300	125	DS802N-C125/0.3A	2CCA892005R0844	211851			0.790	1
	D	300	125	DS802N-D125/0.3A	2CCA892005R0841	211868			0.790	1

3	B	300	125	DS803N-B125/0.3A	2CCA893005R0845	211875			1.14	1
	C	300	125	DS803N-C125/0.3A	2CCA893005R0844	211882			1.14	1
	D	300	125	DS803N-D125/0.3A	2CCA893005R0841	211899			1.14	1

4	B	300	125	DS804N-B125/0.3A	2CCA894005R0845	211905			1.44	1
	C	300	125	DS804N-C125/0.3A	2CCA894005R0844	211912			1.44	1
	D	300	125	DS804N-D125/0.3A	2CCA894005R0841	211929			1.44	1

3



2CCC413257F0001

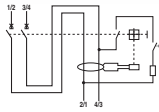

2CCC413259F0001

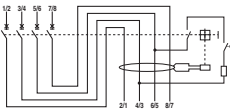

DS800S, A selective type

Function: protection against overload and short-circuit currents; protection against the effects of sinusoidal alternating earth fault currents with an intentional tripping delay, which allows to realize the selectivity with downstream instantaneous devices (for more information about selectivity see the technical guide); protection against indirect contacts; command and isolation of resistive and inductive loads.

Application: industrial.

Standard: IEC/EN 60947-2

Icu=50 kA

Number of poles	Curve	Rated residual current I Δ n mA	Rated current In A	Order details Type code	Order code	Bbn 7612271 EAN	Price 1 piece	Price group	Weight 1 piece kg	Pack unit pc.
2	B	1000	125	DS802S-B125/1AS	2CCC862006R0845	211516			0.790	1
	C	1000	125	DS802S-C125/1AS	2CCC862006R0844	211523			0.790	1
	D	1000	125	DS802S-D125/1AS	2CCC862006R0841	211530			0.790	1
	K	1000	125	DS802S-K125/1AS	2CCC862006R0647	211547			0.790	1
4	B	300	125	DS804S-B125/0.3AS	2CCC864005R0845	211554			1.44	1
		1000	125	DS804S-B125/1AS	2CCC864006R0845	211592			1.44	1
	C	300	125	DS804S-C125/0.3AS	2CCC864005R0844	211561			1.44	1
		1000	125	DS804S-C125/1AS	2CCC864006R0844	211608			1.44	1
	D	300	125	DS804S-D125/0.3AS	2CCC864005R0841	211578			1.44	1
		1000	125	DS804S-D125/1AS	2CCC864006R0841	211615			1.44	1
	K	300	125	DS804S-K125/0.3AS	2CCC864005R0647	211685			1.44	1
		1000	125	DS804S-K125/1AS	2CCC864006R0647	211622			1.44	1

DS800N, A selective type

Function: protection against overload and short-circuit currents; protection against the effects of sinusoidal alternating earth fault currents with an intentional tripping delay, which allows to realize the selectivity with downstream instantaneous devices (for more information about selectivity see the technical guide); protection against indirect contacts; command and isolation of resistive and inductive loads.

Application: industrial.

Standard: IEC/EN 60947-2

Icu=36 kA



2CCC413257F0001

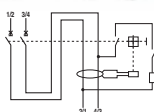

2CCC413259F0001

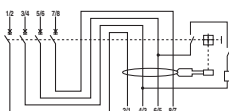

Number of poles	Curve	Rated residual current I Δ n mA	Rated current In A	Order details	Order code	Bbn	Price 1 piece	Price group	Weight 1 piece	Pack unit
				Type code		EAN				
2	B	1000	125	DS802N-B125/1AS	2CCC892006R0845	211639			0.790	1
	C	1000	125	DS802N-C125/1AS	2CCC892006R0844	211646			0.790	1
	D	1000	125	DS802N-D125/1AS	2CCC892006R0841	211653			0.790	1

4	B	300	125	DS804N-B125/0.3AS	2CCC894005R0845	211660			1.44	1
		1000	125	DS804N-B125/1AS	2CCC894006R0845	211691			1.44	1
C	300	125	DS804N-C125/0.3AS	2CCC894005R0844	211677			1.44	1	
	1000	125	DS804N-C125/1AS	2CCC894006R0844	211707			1.44	1	
D	300	125	DS804N-D125/0.3AS	2CCC894005R0841	211684			1.44	1	
	1000	125	DS804N-D125/1AS	2CCC894006R0841	211714			1.44	1	

3

DS800S AP-R, A type

Function: protection against the effects of sinusoidal alternating earth fault currents, providing the best compromise between safety and continuity in the service thanks to the resistance to unwanted trippings; protection against indirect contacts and additional protection against direct ($I_{\Delta n}=30$ mA) contacts; protection and isolation of resistive and inductive loads.

Application: industrial.

Standard: IEC/EN 60947-2

Icu=50 kA



2CCB413257F0001

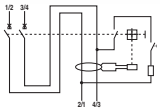

2CCB413258F0001

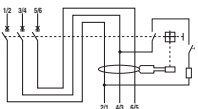

2CCB413259F0001

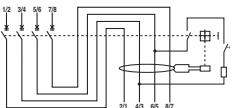

Number of poles	Curve	Rated residual current $I_{\Delta n}$ mA	Rated current I_n A	Order details Type code	Order code	Bbn 7612271	Price 1 piece	Price group	Weight 1 piece	Pack unit
						EAN			kg	pc.
2	B	30	125	DS802SB125/.03AP-R	2CCB862004R0845	211301			0.790	1
	C	30	125	DS802SC125/.03AP-R	2CCB862004R0844	211318			0.790	1
	D	30	125	DS802SD125/.03AP-R	2CCB862004R0841	211325			0.790	1
	K	30	125	DS802SK125/.03AP-R	2CCB862004R0647	211332			0.790	1
3	B	30	125	DS803SB125/.03AP-R	2CCB863004R0845	211349			1.14	1
	C	30	125	DS803SC125/.03AP-R	2CCB863004R0844	211356			1.14	1
	D	30	125	DS803SD125/.03AP-R	2CCB863004R0841	211363			1.14	1
	K	30	125	DS803SK125/.03AP-R	2CCB863004R0647	211370			1.14	1
4	B	30	125	DS804SB125/.03AP-R	2CCB864004R0845	211387			1.44	1
	C	30	125	DS804SC125/.03AP-R	2CCB864004R0844	211394			1.44	1
	D	30	125	DS804SD125/.03AP-R	2CCB864004R0841	211400			1.44	1
	K	30	125	DS804SK125/.03AP-R	2CCB864004R0647	211417			1.44	1

DS800N AP-R, A type

Function: protection against the effects of sinusoidal alternating earth fault currents, providing the best compromise between safety and continuity in the service thanks to the resistance to unwanted trippings; protection against indirect contacts and additional protection against direct ($I_{\Delta n}=30$ mA) contacts; protection and isolation of resistive and inductive loads.

Application: industrial.

Standard: IEC/EN 60947-2

Icu=36 kA

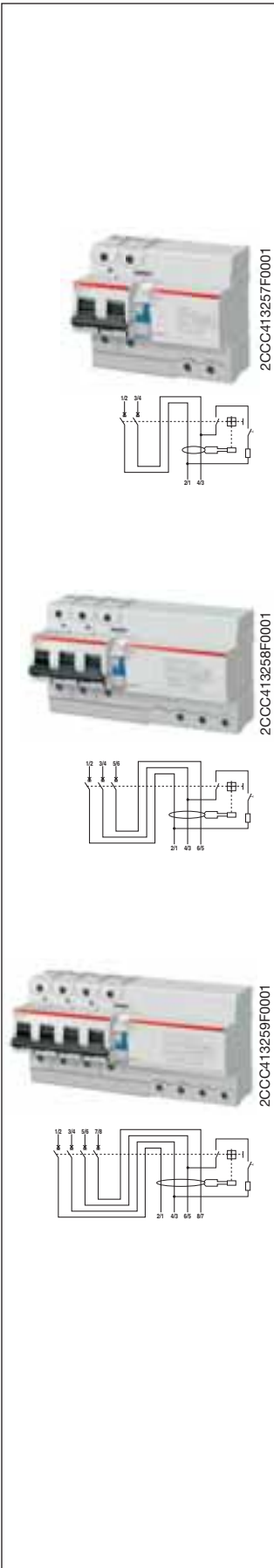

Number of poles	Curve	Rated residual current $I_{\Delta n}$ mA	Rated current I_n A	Order details		Bbn 7612271	Price 1 piece	Price group	Weight 1 piece	Pack unit	
				Type code	Order code						
2	B	30	125	DS802NB125/.03AP-R	2CCB892004R0845	211424			0.790	1	
	C	30	125	DS802NC125/.03AP-R	2CCB892004R0844						211431
	D	30	125	DS802ND125/.03AP-R	2CCB892004R0841						211448
3	B	30	125	DS803NB125/.03AP-R	2CCB893004R0845	211455			1.14	1	
	C	30	125	DS803NC125/.03AP-R	2CCB893004R0844						211462
	D	30	125	DS803ND125/.03AP-R	2CCB893004R0841						211479
4	B	30	125	DS804NB125/.03AP-R	2CCB894004R0845	211486			1.44	1	
	C	30	125	DS804NC125/.03AP-R	2CCB894004R0844						211493
	D	30	125	DS804ND125/.03AP-R	2CCB894004R0841						211509

3

TECHNICAL CHARACTERISTICS

	Standards			
Electrical features	Type (wave form of the earth leakage sensed)			
	Poles			
	Rated current I_n		A	
	Rated sensitivity $I_{\Delta n}$		A	
	Rated voltage U_e		V	
	Insulation voltage U_i			
	Max. operating voltage		V	
	Min. operating voltage		V	
	Rated frequency		Hz	
	Rated breaking capacity acc. to IEC/EN 61009	ultimate I_{cn}		A
	Rated breaking capacity acc. to IEC/EN 60947-2	ultimate I_{cu}		kA
	1P+N @230 VAC, 2P, 3P, 4P @400 VAC	service I_{cs}		kA
	Rated residual breaking capacity $I_{\Delta m}$			kA
	Rated impulse withstand voltage (1.2/50) U_{imp}			kV
	Dielectric test voltage at ind. freq. for 1 min.			kV
	Thermomagnetic release characteristic	B: $3 I_n \leq I_m \leq 5 I_n$ C: $5 I_n \leq I_m \leq 10 I_n$		
Surge current resistance (wave 8/20)			A	
Mechanical features	Toggle			
	Electrical life			
	Mechanical life			
	Protection degree	housing terminals		
	Tropicalization acc. to IEC /EN 60068-2	humid heat constant climatic conditions variable climatic conditions		°C/RH °C/RH °C/RH
	Reference temperature for setting of thermal element			°C
	Ambient temperature (with daily average $\leq +35$ °C)			°C
	Storage temperature			°C
Installation	Terminal type	top bottom		
	Terminal size top/bottom for cables	1P+N line side load side	mm ² mm ² mm ²	
	Tightening torque top/bottom	1P+N	N*m	
	Mounting			
Dimensions and weight	Dimensions (H x D x W)	1P+N	mm	
	Weight	1P+N	g	
Combination with auxiliary elements	Combinable with:	auxiliary contact signal contact shunt trip undervoltage release		



DS 271 AC		DS 271 A
	IEC 61009, BSEN 61009-2-2	
AC		A
	1P+N	
	$6 \leq I_n \leq 40$	
0.01-0.03-0.1-0.3		0.01-0.03-0.1-0.3
	230-240	
	500	
	254	
	85	
	50...60	
	10000	
	-	
	7.5	
	6	
	5	
	2.5	
	■	
	■	
	250	
	black sealable in on-off position	
	10000	
	20000	
	IP4X	
	IP2X	
	28 cycles with 55/95...100	
	23/83 - 40/93 - 55/20	
	25/95 - 40/95	
	30	
	-25...+55	
	-25...+70	
	cage (shock protected)	
	cage (shock protected)	
	-	
	L1: 1 up to 25; N: flexible 4; FE: flexible 0.5	
	L1 and N: 1 up to 10	
	2 top; 1.2 bottom	
	on DIN rail EN 60715 (35 mm) by means of fast clip device	
	120 x 67.6 x 17.5	
	205	
	no	
	no	
	no	
	no	

B

DS 271 AC type, B and C characteristics

Function: protection against overload and short-circuit currents; protection against the effects of sinusoidal alternating earth fault currents; protection against indirect contacts and additional protection against direct contacts ($I_{\Delta n}=30$ mA).

Application: residential, commercial, industrial.

Standard: IEC 61009, BSEN61009-2-2

$I_{cn}=10$ kA



Characteristics/ Curve	Rated residual current $I_{\Delta n}$ mA	Rated current I_n A	Order details Type code	Order code	Bbn 8012542	Price 1 piece	Price group	Weight 1 piece kg	Pack unit pc.
B	10	6	DS271 AC-B6/0.01 ELN	2CSR175092R0065	036753			0.205	1
		10	DS271 AC-B10/0.01 ELN	2CSR175092R0105	036852			0.205	1
		16	DS271 AC-B16/0.01 ELN	2CSR175092R0165	036951			0.205	1
		20	DS271 AC-B20/0.01 ELN	2CSR175092R0205	037057			0.205	1
		25	DS271 AC-B25/0.01 ELN	2CSR175092R0255	037156			0.205	1
	30	32	DS271 AC-B32/0.01 ELN	2CSR175092R0325	037255			0.205	1
		6	DS271 AC-B6/0.03 ELN	2CSR175092R1065	037354			0.205	1
		10	DS271 AC-B10/0.03 ELN	2CSR175092R1105	037453			0.205	1
		16	DS271 AC-B16/0.03 ELN	2CSR175092R1165	037552			0.205	1
		20	DS271 AC-B20/0.03 ELN	2CSR175092R1205	037651			0.205	1
		25	DS271 AC-B25/0.03 ELN	2CSR175092R1255	037750			0.205	1
		32	DS271 AC-B32/0.03 ELN	2CSR175092R1325	037859			0.205	1/20

C

C	10	6	DS271 AC-C6/0.01 ELN	2CSR175092R0064	038559			0.205	1
		10	DS271 AC-C10/0.01 ELN	2CSR175092R0104	038658			0.205	1
		16	DS271 AC-C16/0.01 ELN	2CSR175092R0164	038757			0.205	1/20
		20	DS271 AC-C20/0.01 ELN	2CSR175092R0204	038856			0.205	1
		25	DS271 AC-C25/0.01 ELN	2CSR175092R0254	038955			0.205	1
	30	32	DS271 AC-C32/0.01 ELN	2CSR175092R0324	039051			0.205	1/20
		6	DS271 AC-C6/0.03 ELN	2CSR175092R1064	039150			0.205	1
		10	DS271 AC-C10/0.03 ELN	2CSR175092R1104	039259			0.205	1
		16	DS271 AC-C16/0.03 ELN	2CSR175092R1164	039358			0.205	1
		20	DS271 AC-C20/0.03 ELN	2CSR175092R1204	039457			0.205	1
100	25	DS271 AC-C25/0.03 ELN	2CSR175092R1254	039556			0.205	1	
	32	DS271 AC-C32/0.03 ELN	2CSR175092R1324	039655			0.205	1	
	40	DS271 AC-C40/0.03 ELN	2CSR175092R1404	128755			0.205	1	
	6	DS271 AC-C6/0.1 ELN	2CSR175092R2064	039754			0.205	1	
	10	DS271 AC-C10/0.1 ELN	2CSR175092R2104	039853			0.205	1/20	
300	16	DS271 AC-C16/0.1 ELN	2CSR175092R2164	039952			0.205	1/20	
	20	DS271 AC-C20/0.1 ELN	2CSR175092R2204	040057			0.205	1/20	
	25	DS271 AC-C25/0.1 ELN	2CSR175092R2254	040156			0.205	1	
	32	DS271 AC-C32/0.1 ELN	2CSR175092R2324	040255			0.205	1	
	6	DS271 AC-C6/0.3 ELN	2CSR175092R3064	040354			0.205	1	
300	10	DS271 AC-C10/0.3 ELN	2CSR175092R3104	040453			0.205	1	
	16	DS271 AC-C16/0.3 ELN	2CSR175092R3164	040552			0.205	1	
	20	DS271 AC-C20/0.3 ELN	2CSR175092R3204	040651			0.205	1	
	25	DS271 AC-C25/0.3 ELN	2CSR175092R3254	040750			0.205	1	
	32	DS271 AC-C32/0.3 ELN	2CSR175092R3324	040859			0.205	1	
		40	DS271 AC-C40/0.3 ELN	2CSR175092R3404	128854			0.205	1



DS 271 A type, B and C characteristics

Function: protection against overload and short-circuit currents; protection against the effects of sinusoidal alternating and direct pulsating earth fault currents; protection against indirect contacts and additional protection against direct contacts ($I_{\Delta n}=30$ mA).

Application: commercial, industrial.

Standard: IEC 61009, BSEN61009-2-2

$I_{cn}=10$ kA

Characteristics/ Curve	Rated residual current $I_{\Delta n}$ mA	Rated current I_n A	Order details		Bbn 8012542	Price 1 piece	Price group	Weight 1 piece kg	Pack unit pc.
			Type code	Order code					
B	10	6	DS271 A-B6/0.01 ELN	2CSR175192R0065	032557			0.205	1
		10	DS271 A-B10/0.01 ELN	2CSR175192R0105	032656			0.205	1
		16	DS271 A-B16/0.01 ELN	2CSR175192R0165	032755			0.205	1
		20	DS271 A-B20/0.01 ELN	2CSR175192R0205	032854			0.205	1
		25	DS271 A-B25/0.01 ELN	2CSR175192R0255	032953			0.205	1
		32	DS271 A-B32/0.01 ELN	2CSR175192R0325	033059			0.205	1
	30	6	DS271 A-B6/0.03 ELN	2CSR175192R1065	033158			0.205	1
		10	DS271 A-B10/0.03 ELN	2CSR175192R1105	033257			0.205	1
		16	DS271 A-B16/0.03 ELN	2CSR175192R1165	033356			0.205	1
		20	DS271 A-B20/0.03 ELN	2CSR175192R1205	033455			0.205	1
		25	DS271 A-B25/0.03 ELN	2CSR175192R1255	033554			0.205	1
		32	DS271 A-B32/0.03 ELN	2CSR175192R1325	033653			0.205	1



C	10	6	DS271 A-C6/0.01 ELN	2CSR175192R0064	034353			0.205	1
		10	DS271 A-C10/0.01 ELN	2CSR175192R0104	034452			0.205	1
		16	DS271 A-C16/0.01 ELN	2CSR175192R0164	034551			0.205	1
		20	DS271 A-C20/0.01 ELN	2CSR175192R0204	034650			0.205	1
		25	DS271 A-C25/0.01 ELN	2CSR175192R0254	034759			0.205	1
		32	DS271 A-C32/0.01 ELN	2CSR175192R0324	034858			0.205	1
	30	6	DS271 A-C6/0.03 ELN	2CSR175192R1064	034957			0.205	1
		10	DS271 A-C10/0.03 ELN	2CSR175192R1104	035053			0.205	1/20
		16	DS271 A-C16/0.03 ELN	2CSR175192R1164	035152			0.205	1/20
		20	DS271 A-C20/0.03 ELN	2CSR175192R1204	035251			0.205	1/20
		25	DS271 A-C25/0.03 ELN	2CSR175192R1254	035350			0.205	1
		32	DS271 A-C32/0.03 ELN	2CSR175192R1324	035459			0.205	1
	100	6	DS271 A-C6/0.1 ELN	2CSR175192R2064	035558			0.205	1
		10	DS271 A-C10/0.1 ELN	2CSR175192R2104	035657			0.205	1
		16	DS271 A-C16/0.1 ELN	2CSR175192R2164	035756			0.205	1
		20	DS271 A-C20/0.1 ELN	2CSR175192R2204	035855			0.205	1
		25	DS271 A-C25/0.1 ELN	2CSR175192R2254	035954			0.205	1
		32	DS271 A-C32/0.1 ELN	2CSR175192R2324	036050			0.205	1
	300	6	DS271 A-C6/0.3 ELN	2CSR175192R3064	036159			0.205	1
		10	DS271 A-C10/0.3 ELN	2CSR175192R3104	036258			0.205	1
		16	DS271 A-C16/0.3 ELN	2CSR175192R3164	036357			0.205	1
		20	DS271 A-C20/0.3 ELN	2CSR175192R3204	036456			0.205	1
		25	DS271 A-C25/0.3 ELN	2CSR175192R3254	036555			0.205	1
		32	DS271 A-C32/0.3 ELN	2CSR175192R3324	036654			0.205	1
		40	DS271 A-C40/0.3 ELN	2CSR175192R3404	128656		0.205	1	



Residual current relays with external toroidal transformer can detect leakage currents. Through minidip you can set sensitivity and intervention time.

RD2 residual current relays

Operating voltage V	Order details Type code	Order code	Bbn 8012542 EAN	Price 1 piece	Price group	Weight 1 piece kg	Pack unit pc.
230...400 a.c.	RD2	2CSM142120R1201	058007			0.125	1
48...150 a.c./d.c.	RD2-48	2CSM242120R1201	537809			0.125	1

3

Technical features

Operating voltage	[V]	230÷400 a.c. (RD2) and 48÷150 a.c./d.c. (RD2-48)
Type		A
Frequency	[Hz]	50÷60
Sensitivity settings IΔn	[A]	0.03; 0.1; 0.3; 0.5; 1; 2
Intervention time settings	[s]	Fast (instantaneous); 0.3; 0.5; 1; 2; 5
Contact capacity	[A]	10 at 250 V a.c. (ohmic)
Contact type		NC-C-NO
Operating temperature	[°C]	-5...+40
Modules	[No.]	2
Standards		IEC/EN 62020

Selection of calibration

$I_{\Delta n}$ (A) 0.03 0.1 0.3 0.5 1 2

Fast 0.3 0.5 1 2 5 Time (sec.)

Indications
Green LED: supply voltage present
Red LED: alarm status

More functions
The connection between the toroidal transformer and the residual current relay is continually checked by the relay; if the connection interrupts, the residual current relay enters the "alarm" status. The "test" pushbutton simulates - internally to the RD2 - the residual current conditions for the RD2 to operate. If pushed, the RD2 must enter the alarm status. The "reset" pushbutton allows the residual current relay to return to the starting condition.

OEPN0295

If the configuration is not appropriate, the device will automatically consider as valid the first configuration (according to the diagram) and enter the maximum safety.



RD3 residual current relays

The RD3 family of electronic residual current relays provides residual current protection and monitoring functions according to IEC/EN 60947-2:2006 annex M and can be used in conjunction with all S 200 automatic devices and Tmax range moulded case devices up to T5, for industrial installations.

The RD3 residual current relays can provide status indications through two output contacts.

Operating voltage V	Order details Type code	Order code	Bbn 8012542 EAN	Price 1 piece	Price group	Weight 1 piece kg	Pack unit pc.
12-48 a.c./d.c.	RD3-48	2CSJ201001R0001	748236			0.13	1
230-400 a.c.	RD3	2CSJ201001R0002	734833			0.25	1
12-48 a.c./d.c.	RD3M-48	2CSJ202001R0001	733935			0.13	1
230-400 a.c.	RD3M	2CSJ202001R0002	747031			0.25	1
12-48 a.c./d.c.	RD3P-48	2CSJ203001R0001	734734			0.13	1
230-400 a.c.	RD3P	2CSJ203001R0002	733836			0.25	1

Technical features

	RD3/RD3-48	RD3M/RD3M-48	RD3P/RD3P-48
Operating voltage	RD3: 230-400 Vac +10% / -15% RD3-48: 12-48 Vac/Vdc +10% / -15%	RD3M: 230-400 Vac +10% / -15% RD3M-48: 12-48 Vac/Vdc +10% / -15%	RD3P: 230-400 Vac +10% / -15% RD3P-48: 12-48 Vac/Vdc +10% / -15%
Auxiliary supply frequency	50-60 Hz	50-60 Hz	50-60 Hz
Network monitored frequency	50 Hz -150 Hz*	50 Hz -150 Hz*	50 Hz -150 Hz*
Frequency filter	-	150 Hz fT = 400 Hz	150 Hz fT = 400 Hz
Type	A (up to IΔn=5 A), AC (for higher current)	A (up to IΔn=5 A) AC (for higher current)	A (up to IΔn=5 A) AC (for higher current)
Operating temperature	-25...+70 °C	-25...+70 °C	-25...+70 °C
Maximum power consumption	<3.6 W (RD3), <600 mW (RD3-48)	<3.6W (RD3M), <600mW (RD3M-48)	<3.6 W (RD3P), <600 mW (RD3P-48)
Sensitivity settings IΔn	0.03-0.1-0.3-0.5-1-2-3-5-10-30	0.03-0.1-0.3-0.5-1-2-3-5-10-30	0.03-0.1-0.3-0.5-1-2-3-5-10-30
Tripping time settings Δt	0-0.06-0.2-0.3-0.5-1-2-3-5-10	0-0.06-0.2-0.3-0.5-1-2-3-5-10	0-0.06-0.2-0.3-0.5-1-2-3-5-10
Pre-alarm threshold	-	60%	60%
Max. resistance connection between toroidal transformer and relay	3 W	3 W	3 W
Max. length connection of remote reset button	15 m	15 m	15 m
Output Contact capacity (7-8-9); (10-11-12)	8 A, 250 V a.c.	8 A, 250 V a.c.	8 A, 250 V a.c.
Led bar indicator	-	-	Yes
Max. cable terminals section	2.5 mm ²	2.5 mm ²	2.5 mm ²
Modules	3	3	3
Dimensions	52.8 × 85 × 64.7 mm	52.8 × 85 × 64.7 mm	52.8 × 85 × 64.7 mm
Protection degree	IP20	IP20	IP20
Standards	IEC/EN 60947-2 annex. M	IEC/EN 60947-2 annex. M	IEC/EN 60947-2 annex. M

*RD3 can detect, as a monitor, sinusoidal earth fault currents in networks with frequencies between 50 Hz and 150 Hz.



RD front panel residual current relays

RD front panel residual current relays achieve their protective function in combination with an external toroidal transformer. You can set the sensitivity between 0.025 A and 25 A, the tripping time can vary from 0.02 to 5 seconds.

Residual current relays are available in 48 mm x 48 mm, 72 mm x 72 mm and 96 mm x 96 mm versions.

The RD296 version is provided of dip switch to select the fail safe function (the output contacts will switch both for differential current over the threshold that for the lack of input current). The RD296-S is provided of fail safe function and memory led. The RD296-DIG version is provided of fail safe function (as the precedent). The digital display allows the visualization of differential current $I_{\Delta n}$.

Operating voltage V	Order details Type code	Order code	Bbn 8012542 EAN	Price 1 piece	Price group	Weight 1 piece kg	Pack unit pc.
24, 48 V a.c./V d.c.	RD148-24	2CSG452211R1201	540908			0.112	1
115 V a.c./ d.c., 230 V a.c.	RD148-230	2CSG252211R1201	541004			0.112	1
24, 48 V a.c./V d.c.	RD172-24	2CSG452120R1201	747406			0.322	1
115 V a.c./ d.c., 230 V a.c.	RD172-230	2CSG252120R1201	747505			0.322	1
24, 48 V a.c./V d.c.	RD272-24	2CSG452424R1201	742302			0.322	1
115 V a.c./V d.c.	RD272-115	2CSG352424R1201	742401			0.322	1
115, 230, 400 V a.c.	RD272-230	2CSG152424R1201	742500			0.322	1
24, 48 V a.c./V d.c.	RD196-24	2CSG452130R1201	541103			0.383	1
115 V a.c./ d.c. and 230, 400 V a.c.	RD196-230	2CSG252130R1201	541202			0.383	1
24, 48, 115 V a.c./ V d.c.	RD296-24	2CSG452434R1201	541301			0.383	1
115 V a.c./ V d.c.	RD296-115	2CSG352434R1201	742906			0.383	1
115 V a.c./V d.c. and 230, 400 V a.c.	RD296-230	2CSG152434R1201	541400			0.383	1
24, 48, 115 V a.c./ V d.c.	RD296-S-24	2CSG452435R1201	541509			0.383	1
115 V a.c./ V d.c.	RD296-S-115	2CSG352435R1201	743002			0.383	1
115 V a.c./V d.c. and 230, 400 V a.c.	RD296-S-230	2CSG152435R1201	541608			0.383	1
24, 48 V a.c./ V d.c.	RD296-DIG-24	2CSG452436R1201	743101			0.383	1
115 V a.c./V d.c.	RD296-DIG-115	2CSG352436R1201	743200			0.383	1
115, 230, 400 V a.c.	RD296-DIG-230	2CSG152436R1201	743309			0.383	1

Technical features

	RD148	RD172	RD272	RD196	RD296	RD296-S RD296-DIG
Type	A	A	A	A	A	A
Operating voltage [V]	24, 48, 115, 230 a.c./ 24, 48, 115 d.c.	24, 48, 115, 230 a.c./ 24, 48, 115 d.c.	24, 48, 115, 230, 400 a.c./ 24, 48, 115 d.c.	24, 48, 115, 230, 400 a.c./ 24, 48, 115 d.c.	24, 48, 115, 230, 400 a.c./ 24, 48, 115 d.c.	24, 48, 115, 230, 400 a.c./ 24, 48, 115 d.c.
Operating frequency [Hz]	50 – 60	50 – 60	50 – 60	50 – 60	50 – 60	50 – 60
Current tripping thresholds $I_{\Delta n}$ [A]	from 0.025 to 25	from 0.025 to 25	from 0.025 to 25	from 0.025 to 25	from 0.025 to 25	from 0.025 to 25 (S) from 0.03 to 30 (DIG)
Tripping times [sec.]	from 0.02 to 5	from 0.02 to 5	from 0.02 to 5	from 0.02 to 5	from 0.02 to 5	from 0.02 to 5
Number of contacts [No.]	2	1	2	1	2	2
Contact capacity [A]	5 (250 V a.c.)	5 (250 V a.c.)	5 (250 V a.c.)	5 (250 V a.c.)	5 (250 V a.c.)	5 (250 V a.c.)
Contact type	change over	change over	change over	change over	change over	change over
Working temperature [°C]	-10...+60	-10...+60	-10...+60	-10...+60	-10...+60	-10...+60
Storage temperature [°C]	-10...+70	-10...+70	-10...+70	-10...+70	-10...+70	-10...+70
Dissipated power [W]	7 max.	7 max.	7 max.	7 max.	7 max.	7 max.
Dimensions W x H [mm]	48 x 48	72 x 72	72 x 72	96 x 96	96 x 96	96 x 96
Display	-	-	-	-	-	yes
Applicable standards	EN 62020 IEC 62020	EN 62020 IEC 62020	EN 62020 IEC 62020	EN 62020 IEC 62020	EN 62020 IEC 62020	EN 62020 IEC 62020



2CSG400494FD201

Toroidal transformers

Dimension Ø mm	Order details Type code	Order code	Bbn 8012542 EAN	Price 1 piece	Price group	Weight 1 piece kg	Pack unit pc.
29 (modular version)	TRM	2CSM029000R1211	020707			0.170	1
35	TR1	2CSG035100R1211	020301			0.212	1
60	TR2	2CSG060100R1211	020400			0.274	1
80	TR3	2CSG080100R1211	020509			0.454	1
110	TR4	2CSG110100R1211	020608			0.530	1
110 (openable version)	TR4/A	2CSG110200R1211	743408			0.600	1
160	TR160	2CSG160100R1211	743507			1.350	1
160 (openable version)	TR160A	2CSG160200R1211	743606			1.600	1
210	TR5	2CSG210100R1211	024804			1.534	1
210 (openable version)	TR5/A	2CSG210200R1211	065708			1.856	1

3



2CSC400263F0201



2CSC400189F0201



2CSC400187F0201

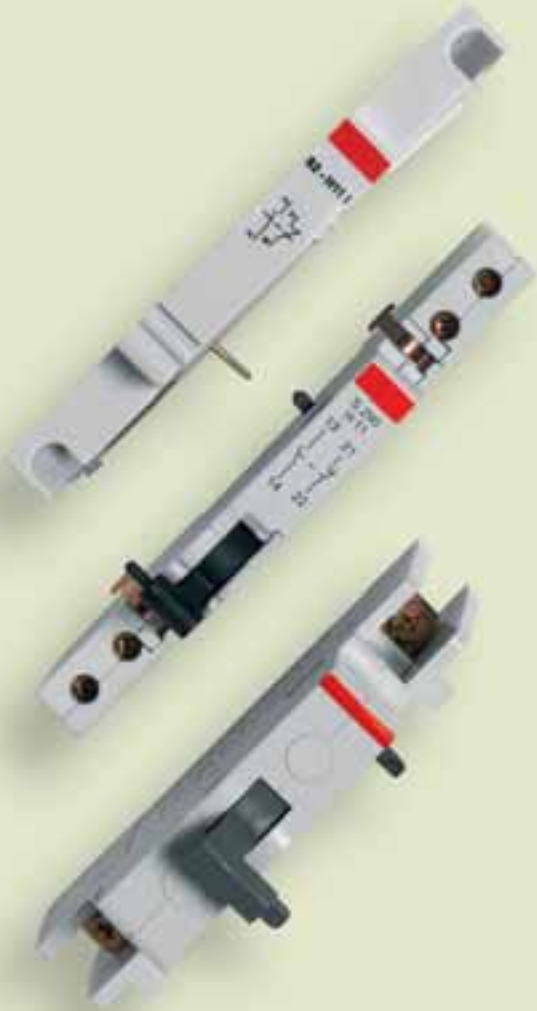

Index

Auxiliary elements and accessories for MCBs S 200 and SN 201, RCDs F 200, DS201, DS202C and DS 200 series	4/3
Auxiliary elements and accessories for MCBs S 280, S 290, S 700, S800 and S 500 series and for RCD-blocks DDA 800	4/45

New System pro *M* compact range of auxiliary elements and accessories is universal: in fact it is suitable for MCBs S 200 and SN 201 range, for RCDs F 200 range and also for RCBOs DS 200 range and it is useful in terms of stock management.

The auxiliary elements range (composed by auxiliary and signal contacts, shunt trips, undervoltage releases and automatic reclosing units) is quite wide and there are different possible schemes for assemblage with devices. Thus MCBs and RCDs performances are improved, even because innovative and integrated solutions can be used in every installation.

The connection accessories range (busbars, connection terminals, feeder terminals) allows any kind of wiring. The range of standard accessories (labels, covers) permits to customize the installation.



2CSC400258F0201



2CSC400263F0201

ABB Auxiliary elements and accessories for MCBs S 200 and SN 201, RCDs F 200, DS201, DS202C and DS 200 series



Index

Schemes for combination of auxiliary elements and S 200, SN 201, F 200, DS201, DS202C and DS 200 series and accessories for MCBs S 200 and SN 201, RCDs F 200, DS201, DS202C and DS 200 series	4/4
Technical features of auxiliary elements and accessories for MCBs S 200 and SN 201, RCDs F 200, DS201, DS202C and DS 200 series	4/6
Technical features - Busbars for MCBs S 200 and SN 201, RCDs F 200, DS201, DS202C and DS 200 series	4/8
Selection tables of auxiliary elements and accessories for MCBs S 200 and SN 201, RCDs F 200, DS201, DS202C and DS 200 series	
Signal/auxiliary contacts	4/12
Auxiliary contacts	4/12
Bottom-fitting auxiliary contacts for S 200, S 200 M, S 200 P	4/12
Auxiliary contact bridge for bottom-fitting auxiliary contacts	4/12
Signal contacts for SN 201	4/12
Auxiliary contact/interface module for SN 201.....	4/12
Signal/auxiliary contacts for F 200 125 A and F 200 B.....	4/13
Clamping cover for F 200 125 A and F 200 B.....	4/13
Shunt trips.....	4/13
Undervoltage releases.....	4/14
Overvoltage releases.....	4/14
Hand operated neutral	4/14
Accessories for S 200 U and S 200 UP	4/15
Mechanical tripping device	4/15
Plug-in base	4/15
Motor operating devices	4/16
Auto-reclosing units	4/16
Home automatic resetting unit.....	4/16
Home automatic resetting unit with autotest	4/16
Modular DIN rail device with USB cable	4/22
Busbars	4/23
Other accessories	4/36

Combination of auxiliary elements with S 200, DDA 200 + S 200 or DS 200

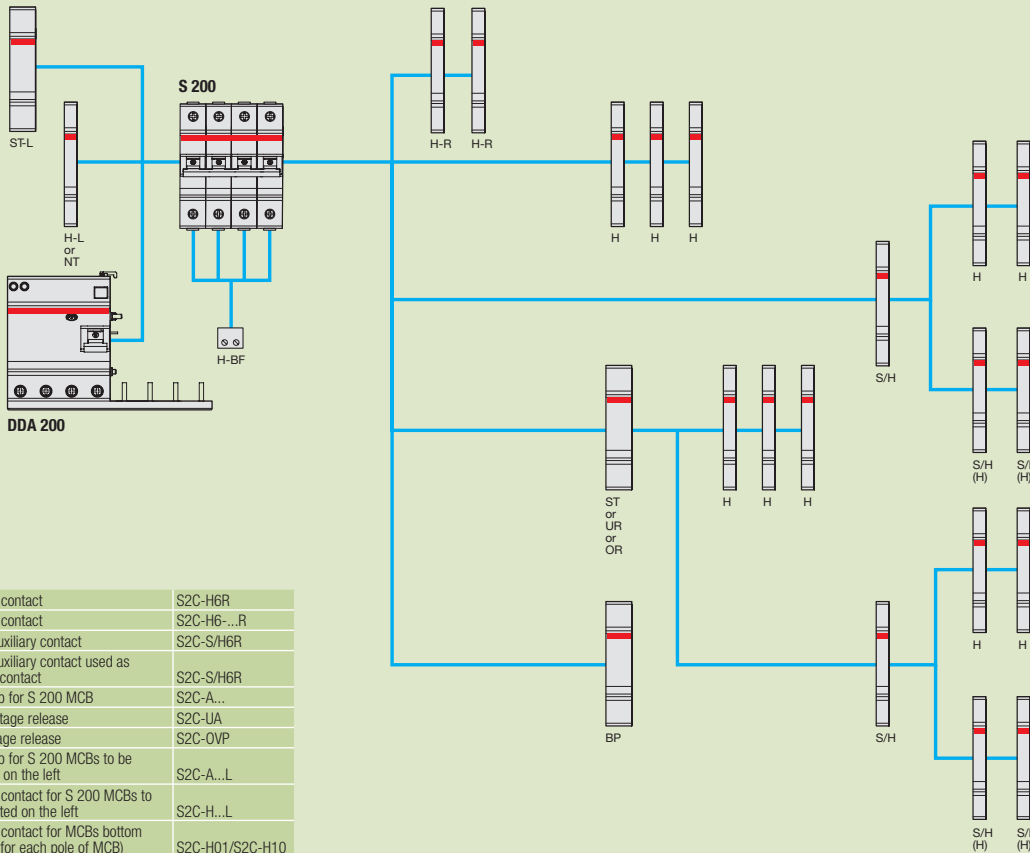

H	Auxiliary contact	S2C-H6R
H-R	Auxiliary contact	S2C-H6-...R
S/H	Signal/Auxiliary contact	S2C-S/H6R
S/H (H)	Signal/Auxiliary contact used as auxiliary contact	S2C-S/H6R
ST	Shunt trip for S 200 MCB	S2C-A...
UR	Undervoltage release	S2C-UA
OR	Oversvoltage release	S2C-OVP
ST-L	Shunt trip for S 200 MCBs to be mounted on the left	S2C-A...L
H-L	Auxiliary contact for S 200 MCBs to be mounted on the left	S2C-H...L
H-BF	Auxiliary contact for MCBs bottom fitting (1 for each pole of MCB)	S2C-H01/S2C-H10
BP	Mechanical tripping device	S2C-BP
NT	Switched neutral	S2C-Nt

2CSC400010F0202

Combination of S 200 with motor operating device

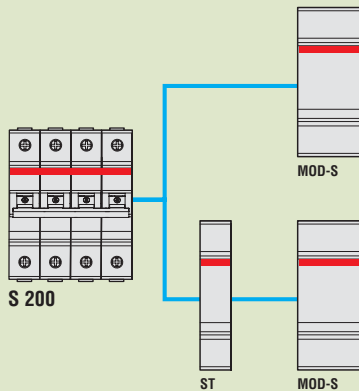

ST	Shunt trip for S 200 MCB S	S2C-A...
MOD-S*	Motor operating device	S2C-CM...

* in case of using S 200 coupled with DDA 200, MOD-S doesn't operate in case of earth-leakage fault

2CSC400011F0202

Combination of auxiliary elements with SN 201

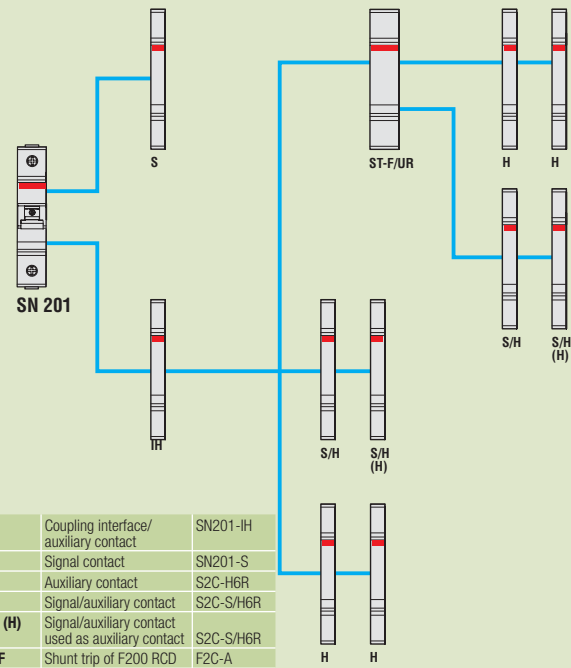

IH	Coupling interface/auxiliary contact	SN201-IH
S	Signal contact	SN201-S
H	Auxiliary contact	S2C-H6R
S/H	Signal/auxiliary contact	S2C-S/H6R
S/H (H)	Signal/auxiliary contact used as auxiliary contact	S2C-S/H6R
ST-F	Shunt trip of F200 RCD	F2C-A
UR	Undervoltage release	S2C-UA

2CSC400011F0202

System

pro *M* compact®

Schemes for combination

Auxiliary elements and accessories for MCBs S 200 and SN 201, RCDs F 200, DS201, DS202C and DS 200 series

Combination of home automatic resetting unit with F 200

F 200 *

ARH Home automatic resetting unit F2C-ARH

* F 202 30 mA, max 63 A

2CSC400011F0202

Combination of auxiliary elements with F 200

F 200

AR/MOD-F

STF or UR or OR

H or S/H

H	Auxiliary contact	S2C-H6R
S/H	Signal/Auxiliary contact	S2C-S/H6R
S/H (H)	Signal/Auxiliary contact used as auxiliary contact	S2C-S/H6R
UR	Undervoltage release	S2C-UA
OR	Oversvoltage release	S2C-OVP
AR	Auto reclosing unit	F2C-ARI
MOD-F	Motor operating device	F2C-CM
ST-F	Shunt trip for F 200 RCCB	F2C-A

2CSC400010F0202

Combination of auxiliary elements with F 204 125 A, B type, PV B

F2 125 A S/H

F 204 125 A
F 204 B type
F 204 PV B

F2 125 A S/H Signal/Auxiliary contact

2CSC400010F0202

Combination of auxiliary elements with DS201, DS202C

DS201
DS202C

+ MOD-DS

+ S/H + H

+ S/H + S/H (H)

+ H + H

+ ST-F + H + H

+ ST-F + S/H + S/H (H)

+ UR + H + H
+ OR + H + H

+ UR + S/H + S/H (H)
+ OR + S/H + S/H (H)

H	Auxiliary contact	S2C-H6R
S/H	Signal/Auxiliary contact	S2C-S/H6R
S/H (H)	Signal/Auxiliary contact used as auxiliary contact	S2C-S/H6R
ST-F	Shunt trip for F 200 RCCB	F2C-A
UR	Undervoltage release	S2C-UA
OR	Oversvoltage release	S2C-OVP
MOD-DS	Motor operating device	DS2C-CM

2CSC400012F0202

System

pro M compact®

Technical features

Auxiliary elements and accessories for MCBs S 200 and SN 201, RCDs F 200, DS201, DS202C and DS 200 series

Auxiliary contact and signal/auxiliary contact			S2C-H6R, S2C-H11L, S2C-H20, S2C-H02 and S2C-S/H6R											
Rated current		A	10											
Min. rated voltage UBmin	AC	V	24											
	DC	V	24											
Min. rated operational current/voltage			10 mA at 12 V; 5 mA at 24 V											
Short-circuit withstand capacity		V	230 a.c. 100A with S201 K4											
Overvoltage category			III											
Surge voltage (1.2/50 ms)		kV	4											
Connection cross section		mm ²	0.75...2.5 (up to 2 x 1.5 mm ² for S2C-H11L, S2C-H20L and S2C-H02L)											
Tightening torque		Nm	1.2 (max. 0.8 for S2C-H11L, S2C-H20L and S2C-H02L)											
Contact stability in vibration test according to DIN IEC 68-2-6			5g, 20 sweep cycles 5...150...5 Hz at 24 V AC/DC, 5 mA automatic reclosing < 10 ms											
Mechanical service life			10000 operations											
Dimensions (H x D x W)		mm	85 x 69 x 8.8											
Auxiliary contact and signal/auxiliary contact			S2C-H6-11R, S2C-H6-20R, S2C-H6-02R											
Rated current		A	10											
Min. rated voltage UBmin	AC	V	24											
	DC	V	24											
Min. rated operational current/voltage			10 mA at 12 V; 5 mA at 24 V											
Overvoltage category			III											
Surge voltage (1.2/50 ms)		kV	4											
Connection cross section		mm ²	0.75...2.5											
Tightening torque		Nm	1.2											
Mechanical service life			10000 operations											
Dimensions (H x D x W)		mm	85 x 69 x 8.8											
Bottom-fitting auxiliary contact			S2C-H10 and S2C-H01											
Contact complement			1NO (1 make contact), 1NC (1 normally closed contact), leading make contact, late closing											
Contact load			AC14 2 A/230 V - DC 12 identical DC13/DC13 1 A /50 V, 2 A/30 V											
Min. rated voltage		V	12 AC/DC at 0.1 VA											
Short-circuit withstand capacity			230 VAC 1000 A, fault protection with S 201-K2 or Z2											
Electrical serviceable life			> 4000 switchover cycles											
Standard			VDE 0106 Part 101											
Connection cross-section		mm ²	0.75 to 2.5											
Tightening torque		N*m	0.5											
Signal auxiliary contact for F 200 125A and F 200 B			F2 125A-S/H											
Rated current	AC	A	6											
	DC	A	1											
Min. rated voltage Ub min	AC	V	230											
	DC	V	110											
Connection cross section		mm ²	1...1.5											
Tightening torque		Nm	0.8											
Dimensions (H x D x W)		mm	85 x 69 x 8.8											
Shunt trip for S 200 MCBs			S2C-A1						S2C-A2					
Rated voltage	AC	V	12...60						110...415					
	DC	V	12...60						110...250					
Max release duration		ms	<10						<10					
Min. release voltage	AC	V	7						55					
	DC	V	10						80					
Consumption on release	Ub	V	12 DC	12 AC	24 DC	24 AC	60 DC	60 AC	110 DC	110 AC	220 DC	230 AC	415 AC	
	Ib max	A	2.2	2.5	4.5	5	14	8.8	0.35	0.5	1.1	1.0	2.7	
Coil resistance		Ω	3.7						225					
Terminals		mm ²	16						16					
Tightening torque		Nm	2.5						2.5					
Dimensions (H x D x W)		mm	85 x 69 x 17.5						85 x 69 x 17.5					
Shunt trip for F 200 RCCBs			F2C-A1						F2C-A2					
Rated voltage	AC	V	12...60						110...415					
	DC	V	12...60						110...250					
Max release duration		ms	10						10					
Min. release voltage	AC	V	6						75					
	DC	V	4.5						55					
Consumption on release	Ub	V	12 DC	12 AC	24 DC	60 DC	60 AC	110 DC	110 AC	250 DC	415 AC			
	Ib max	A	0.88	0.65	1.58	5.8	5	0.05	0.03	0.1	0.16			
Coil resistance		Ω	5.5						1355					
Terminals		mm ²	2x1.5						2x1.5					
Tightening torque		Nm	0.2						0.2					
Dimensions (H x D x W)		mm	85 x 69 x 17.5						85 x 69 x 17.5					

System

pro M compact®

Technical features

Auxiliary elements and accessories for MCBs S 200 and SN 201, RCDs F 200, DS201, DS202C and DS 200 series

Undervoltage release			S2C-UA 12 DC	S2C-UA 24 AC	S2C-UA 24 DC	S2C-UA 48 AC	S2C-UA 48 DC	S2C-UA 110 AC	S2C-UA 110 DC	S2C-UA 230 AC	S2C-UA 230 DC	S2C-UA 230 DC	S2C-UA 400 AC
Standards			IEC/EN 60947-1										
Rated voltage	AC	V		24		48		110		230			400
	DC	V	12		24		48		110		230		
Frequency		Hz	50...60										
Release trip		V	0.35 Un ≥ V ≥ 0.7 Un										
Terminals		mm ²	2x1.5										
Consumption		VA	2.2	3.6	2	3.6	2.1	3.5	2.2	3.7	2.3	2.4	
Resistance to corrosion		°C/RH	constant atmosphere: 23/83 - 40/93 - 55/20; variable atmosphere: 25/95 - 40/93										
Protection degree			IPXXB/IP2X										
Tightening torque		Nm	0.4										
Dimensions (H x D x W)		mm	85 x 69 x 17.5										

Overvoltage release			S2C - OVP2				S2C - OVP1			
Rated voltage		VAC					230			
Rated frequency		Hz					50			
Max non-tripping voltage AC		V					253			
Max tripping voltage AC		V	290				275			
Tripping time	@ 290V AC	s					t<1			
	@ 380V AC	s					t<0.1			
Peak current	@ 315V AC	A					1			
	@ 440V AC	A					1.8			
Max duration of impulse command		ms					7			
Operating temperature		°C					-5...+40			

Hand operated neutral left side mounted			S2C-Nt			
Rated current		A	max. 40			
Terminal		mm ²	10; box terminal			
Tightening torque		Nm	1.2			
Dimensions (H x D x W)		mm	85 x 69 x 8.8			

Signal and auxiliary contacts			SN201-S			SN201-IH		
Terminals		mm ²				2x1,5		
Tightening torque		N				1.2		
Dimensions		mm	H: 85 x D: 68 x W: 8.9			H: 85 x D: 68,7 x W: 8.9		
Rated voltage		V				230		
Rated current		A				2		

Utilization category and contact capacity SN201-S, SN201-IH					
AC14	Ue	V	400		230
	Ie	A	1		2
DC12	Ue	V	220		110
	Ie	A	1		1,5
DC13	Ue	V	60		24
	Ie	A	2		4

Busbars PS, PS...SP, PS...BP

Materials	Busbar: E – Cu 58 F25 insulation: PS PC / ABS PS...SP PC / ABS PS...BP PA 66
Heat deflection temp.	PS VST B 120 – ISO 306 = 113 °C – UL94-V0/1,5 PS...SP VST B 120 – ISO 306 = 113 °C – UL94-V0/1,5 PS...BP HDT B – ISO179 = 200 °C – UL94-V0/0,4 mm
Climate stability	according to DIN EN 60068
Insulation coordination	Overvoltage category III / Pollution degree 2
Comparative tracking index	600 V
Standards	PS DIN EN 60947-1 VDE 0660 part 100 = IEC 60947-1:2004 PS...SP DIN EN 60947-1 VDE 0660 part 100 = IEC 60947-1:2004; UL1077 PS...BP DIN EN 60947-1 VDE 0660 part 100 = IEC 60947-1:2004; UL489
Dielectric strength	PS 32 kV/mm PS...SP 32 kV/mm PS...BP 30 kV/mm
Impulse voltage strength	PS 4.5 kV PS...SP 9.5 kV PS...BP 9.5 kV
Operation voltage	PS 690 VAC PS...SP 480 VAC PS...BP 480 VAC
Busbar cross section	10/16/30 mm ²
Max. current Is phase	see chart below
Short circuit withstand capacity	PS 25 kA with back up fuse NH3 355 A gG/gL500V PS...SP 10 kA with back up fuse NH3 355 A gG/gL500V PS...BP 10 kA with back up fuse NH3 355 A gG/gL500V

4

Current carrying capacity at 35 °C (depending on feeding)

End feeding		busbar blocks PS		
cross section/mm ²		10	16	30
max. supply current I _s /phase	A	63	80 ¹⁾	120*

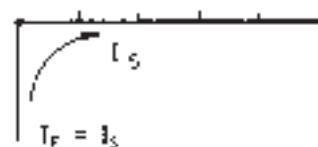

Non-end feeding (center or elsewhere on the rail)

Non-end feeding (center or elsewhere on the rail)		busbar blocks PS		
cross section/mm ²		10	16	30
max. current in branch I _z /phase	A	100	130 ¹⁾²⁾	160*
max. supply current I _s /phase	A	depends on cross section		



* If fed via the terminals, always ensure that 130 A (110 A for terminals 16 mm²) are not exceeded, irrespective of the current carrying capacity (I_s) of the busbar

¹⁾ PS...BP 115 A if cubicle size ≥ 30" x 30" x 10"

²⁾ PS...SP 100 A

System

pro M compact®

Technical features

Auxiliary elements and accessories for MCBs S 200 and SN 201, RCDs F 200, DS201, DS202C and DS 200 series

Undervoltage release			S2C-UA 12 DC	S2C-UA 24 AC	S2C-UA 24 DC	S2C-UA 48 AC	S2C-UA 48 DC	S2C-UA 110 AC	S2C-UA 110 DC	S2C-UA 230 AC	S2C-UA 230 DC	S2C-UA 400 AC
Standards			IEC/EN 60947-1									
Rated voltage	AC	V		24	24	48		110		230		400
	DC	V	12				48		110		230	
Frequency		Hz	50...60									
Release trip		V	0.35 Un ≥ V ≥ 0.7 Un									
Terminals		mm ²	2x1.5									
Consumption		VA	2.2	3.6	2	3.6	2.1	3.5	2.2	3.7	2.3	2.4
Resistance to corrosion		°C/RH	constant atmosphere: 23/83 - 40/93 - 55/20; variable atmosphere: 25/95 - 40/93									
Protection degree			IPXXB/IP2X									
Tightening torque		Nm	0.4									
Dimensions (H x D x W)		mm	85 x 69 x 17.5									

Overvoltage release			S2C - OVP2				S2C - OVP1			
Rated voltage		VAC					230			
Rated frequency		Hz					50			
Max non-tripping voltage AC		V					253			
Max tripping voltage AC		V	290				275			
Tripping time	@ 290V AC	s					t<1			
	@ 380V AC	s					t<0.1			
Peak current	@ 315V AC	A					1			
	@ 440V AC	A					1.8			
Max duration of impulse command		ms					7			
Operating temperature		°C					-5...+40			

Hand operated neutral left side mounted			S2C-Nt			
Rated current		A	max. 40			
Terminal		mm ²	10; box terminal			
Tightening torque		Nm	1.2			
Dimensions (H x D x W)		mm	85 x 69 x 8.8			

4

System

pro M compact®

Technical features

Auxiliary elements and accessories for MCBs S 200 and SN 201, RCDs F 200, DS201, DS202C and DS 200 series

Motor operating devices			S2C-CM	F2C-CM
Supply	V		12 ... 30 V a.c. +10% - 15% (50-60Hz); 12 ... 48 V d.c. +10% - 15%	
Power consumption during the operation	12 V a.c.	VA	< 15	
	24 V a.c.	VA	< 22	
	30 V a.c.	VA	< 25	
	12 ... 48 V d.c.	VA	< 20	
Power consumption at rest	VA	< 1.5		
Make-time at ambient temperature	sec	< 1		
Opening time at ambient temperature	sec	< 0.5		
Number of operations		< 20.000		
Operating temperature	°C	- 25 ... + 55		
Cables length of control circuit	m	< 1500		
Cables cross-section	mm ²	< 2.5		
Signal contact (terminals 3 – 4 – 5)	Current carrying capacity	1NA + 1NC (change-over contact) 5 A (250 V AC) (inductive-ohmic load)		
Auxiliary contact (terminals 6 – 7 – 8)	Current carrying capacity	1NA + 1NC (change-over contact) 3 A (250 V AC) (inductive-ohmic load)		
Remote control*		By means of dry contacts		
Remote control terminals		Terminal 9 = make contact; Terminal 10 = opening contact Terminal 11 = common reference for control contacts, +5V d.c. (supplied by the motor operating device)		

- * Note:
- 1- After having powered the device, wait 5 seconds before activating the control functions.
 - 2- In case of the device opening due to a fault, please wait 8 seconds before attempting to reclose the motor operator.

Motor operating devices			DS2C-CM
Supply	V		12 ... 30 V a.c. +10% - 15% (50-60Hz); 12 ... 48 V d.c. +10% - 15%
Insulation voltage	V		2500 for 1 minute
Power consumption during the operation	12 V a.c.	VA	< 15
	24 V a.c.	VA	< 22
	30 V a.c.	VA	< 25
	12 ... 48 V d.c.	VA	< 20
Power consumption at rest	VA	< 1.5	
Remote control *		by means of dry contacts	
Make-time at ambient temperature	sec	< 1	
Opening time at ambient temperature	sec	< 0.5	
Time before attempting to reclose the motor operator	sec	8	
Number of operations		< 20.000	
Operating temperature	°C	- 25 ... + 55	
Storage temperature	°C	- 40 ... + 70	
Mounting		on DIN rail EN 60715 by means of fast clip device	
Protection degree (EN 60529)		terminals: IP2X enclosure: IP4X	
Cables length of control circuit	m	< 1500	
Cables cross-section	mm ²	< 2.5	
Signal contact (terminals 3 – 4 – 5)	Current carrying capacity	1NO + 1NC (change-over contact) 5 A (250 V AC) (resistive load)	
Auxiliary contact (terminals 6 – 7 – 8)	Current carrying capacity	1NO + 1NC (change-over contact) 3 A (250 V AC) (resistive load)	
Remote control terminals		Terminal 9 = make contact; Terminal 10 = opening contact Terminal 11 = common reference for control contacts, +5 V d.c. (supplied by the motor operating device)	

- * Note:
- 1- After having powered the device, wait 5 seconds before activating the control functions.
 - 2- In case of the device opening due to a fault, please wait 8 seconds before attempting to reclose the motor operator.

System

pro M compact®

Technical features

Auxiliary elements and accessories for MCBs S 200 and SN 201, RCDs F 200, DS201, DS202C and DS 200 series

Auto-reclosing unit		F2C-ARI		F2C-ARI30	
Supply	V	12 ... 30 V a.c. +10% - 15% (50-60Hz); 12 ... 48 V d.c. +10% - 15%			
Number of automatic reset attempts		3			
Time of reset of the auto-reset meter	sec	16		45	
Power consumption during the operation	12Va.c.	VA	< 15		
	24Va.c.	VA	< 22		
	30Va.c.	VA	< 25		
	12 ... 48Vd.c.	VA	< 20		
Power consumption at rest	VA	< 1.5			
Waiting time between auto-reset attempts	sec	3		30	
Closing time at ambient temperature	sec	< 1			
Opening time at ambient temperature	sec	< 0.5			
Number of operations		< 20.000			
Operating temperature	°C	- 25 ... + 55			
Cables length of control circuit	m	< 1500			
Cables cross-section	mm ²	< 2.5			
Signaling contact to signal a locked state following three auto-reset attempts (terminals 3 – 4 – 5)		1NA + 1NC (change-over contact)			
Current carrying capacity		5 A (250 V AC) (ohmic load)			
Auxiliary contact (terminals 6 – 7 – 8)		1NA + 1NC (change-over contact)			
Current carrying capacity		3 A (250 V AC) (ohmic load)			
Remote control		By means of dry contacts			
Remote control terminals		Terminal 9 = closing and remote reset contact for locked state; Terminal 10 = opening contact Terminal 11 = common reference for control contacts, +5V d.c. (supplied by the motor operating device)			

* After having powered the device, wait 5 seconds before activating the control functions.

Home automatic resetting unit		F2C-ARH /F2C-ARH-T	
Power supply	VAC	230	
Number of automatic reclosing attempts		1	
Reset time for counter of automatic reclosing attempts	sec	12	
Power absorbed during the operation	VA	(t<0.5s) 20 max	
Power consumption in stand-by	W	0.4 max	
Number of operations		≤ 10.000	
Operating temperature	°C	-25 ... + 55	
Signal contact cable section	mm ²	≤ 2.5	
Signal contact for the locked state (terminals 1-2)		1NA (change-over contact)	
Signal contact rated current	A	3 (250V AC)	

Accessories for range S 200 U and S 200 UP acc. to UL 489/CSA-22.2 No.5

Auxiliary contact and signal contact		S2C-H6R U, S2C-S/6R U	
Rated current	A	10	
Min. rated voltage UBmin	AC	24	
	DC	24	
Min. rated operational current/voltage		10 mA at 12 V; 5 mA at 24 V	
Short-circuit withstand capacity	V	230 a.c. 100A with S201 K4	
Overtoltage category		III	
Surge voltage (1.2/50 ms)	kV	4	
Connection cross section	mm ²	0.75...2.5	
Tightening torque	Nm	1.2	
Contact stability in vibration test		5g, 20 sweep cycles 5...150...5 Hz according to DIN IEC 68-2-6 at 24 V AC/DC, 5 mA automatic reclosing < 10 ms	
Mechanical service life		10000 operations	
Dimensions (H x D x W)	mm	100 x 69 x 8.8	

Shunt trip		S2C-A1 U						S2C-A2 U					
Rated voltage	AC	V	12...60						110...415				
	DC	V	12...60						110...250				
Max release duration		ms	<10						<10				
Min. release voltage	AC	V	7						55				
	DC	V	10						80				
Consumption on release	Ub	V	12 DC	12 AC	24 DC	24 AC	60 DC	60 AC	110 DC	110 AC	220 DC	230 AC	415 AC
	lb max	A	2.2	2.5	4.5	5	14	8.8	0.35	0.5	1.1	1.0	2.7
Coil resistance		Ω	3.7						225				
Terminals		mm ²	16						16				
Tightening torque		Nm	2						2				
Dimensions (H x D x W)		mm	100 x 69 x 17.5						100 x 69 x 17.5				

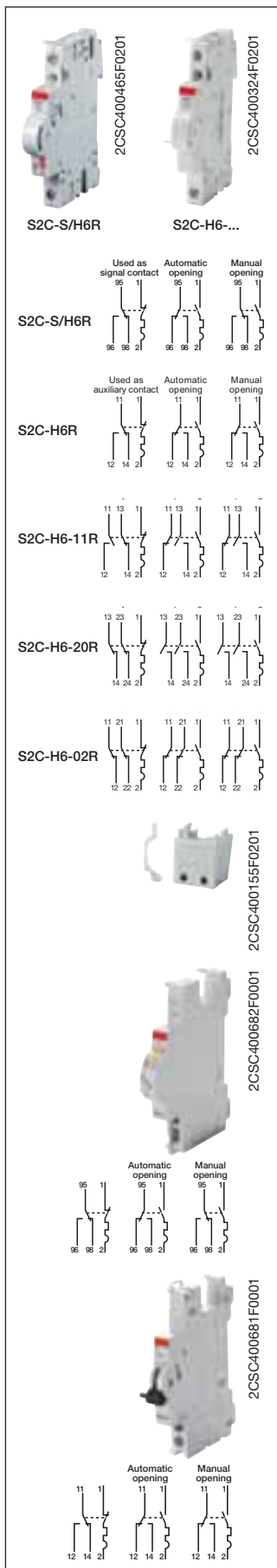

Signal/auxiliary contacts

Function S2C-S/H6R: choice through a selector between indication of the position of the device's contacts and signalling of the fault (overcurrent/short-circuit for MCBs and RCBOs; earth fault for RCCBs and RCBOs). Suitable for MCBs S 200 series, RCCBs F 200 series, RCBOs DS201, DS202C, DS 200 series.

Function S2C-H6R: indication of the position of the device's contacts. Suitable for MCBs S200 series. To be mounted on the left side of the MCBs thanks to the special pin. They are not suitable to be mounted together with RCD-block DDA200.

Function S2C-H6-xxR: indication of the position of the MCB contact. Mounted on the right side. They are not suitable to be mounted together with RCD-block DDA200 and/or other auxiliary contacts.

Description	Order details	Bbn	Price	Price group	Weight	Pack unit
Type code	Order code	EAN	1 piece		1 piece	pc.
Signal contact/ auxiliary switch 1CO	S2C-S/H6R	2CDS200922R0001	563819		0.04	1
Auxiliary contact 1CO	S2C-H6R	2CDS200912R0001	563826		0.04	1
Auxiliary contact 1NO/1NC	S2C-H6-11R	2CDS200946R0001	697941		0.04	1
Auxiliary contact 2NO	S2C-H6-20R	2CDS200946R0002	697958		0.04	1
Auxiliary contact 2NC	S2C-H6-02R	2CDS200946R0003	697965		0.04	1

Auxiliary contacts mounting on the left side

Description	Order details	Bbn	Price	Price group	Weight	Pack unit
Type code	Order code	EAN	1 piece		1 piece	pc.
Auxiliary contact 1 NO/1NC	S2C-H11L	2CDS200936R0001	648820		0.04	1
Auxiliary contact 2 NO	S2C-H20L	2CDS200936R0002	648837		0.04	1
Auxiliary contact 2 NC	S2C-H02L	2CDS200936R0003	648844		0.04	1

Bottom-fitting auxiliary contacts for S 200, S 200 M, S 200 P

1 NC	S 2C-H01	2CDS 200 970 R0001	64551 5		0.01	1
1 NO	S 2C-H10	2CDS 200 970 R0002	64552 2		0.01	1

packing unit 15 parts

1 NC	S 2C-H01 15x	2CDS 200 970 R0011	64677 2		0.01	15
1 NO	S 2C-H10 15x	2CDS 200 970 R0012	64681 9		0.01	15

Auxiliary contact bridge for bottom-fitting auxiliary contacts

Wire jumper for integrated auxiliary contact (MCB S 200 H or auxiliary contacts S2C-H01/S2C-H10 for series connections (HKB) or parallel connections (HKB1).

1/2 mod.	HKB	GH V036 0504 R0100	523134		0.001	1000
1 mod.	HKB 1	GH V036 0504 R0101	524209		0.001	1000

Signal contact for SN201 MCBs

Function: indication of the device contact positions only after the automatic release of the MCBs due to overcurrent.

Description	Order details	Bbn	Price	Price group	Weight	Pack unit
Type code	Order code	EAN	1 piece		1 piece	pc.
Signal contact 1NO + 1 NC	SN201-S	2CSS200924R0001	104957		0.040	1

Auxiliary contact / interface module for SN201 MCBs

Function: indication of the device contact positions. The auxiliary contact can be used as an interface module between SN201 and other compact auxiliary elements.

Description	Order details	Bbn	Price	Price group	Weight	Pack unit
Type code	Order code	EAN	1 piece		1 piece	pc.
Interface module/Aux. Contact 1NO+1NC	SN201-IH	2CSS200923R0001	104858		0.050	1



Signal/auxiliary contact for F 200 125A and F 200 B

Function: choice through a selector between indication of the position of the device's contacts and signalling of the earth fault. Suitable for RCCBs F 200 125A and F 200 B series

Description	Order details		Bbn	Price	Price	Weight	Pack
	Type code	Order code	8012542	1 piece	group	1 piece	unit
			EAN			kg	pc.
Signal/auxiliary contact	F2 125A-S/H	2CSS200922R0001	941408			0.04	1

Clamping cover for F200 125A-F200 B type

	Order details		Bbn	Price	Price	Weight	Pack
	Type code	Order code	8012542	1 piece	group	1 piece	unit
			EAN			kg	pc.
	CPV B	2CSF200988R0001	999638				1

Shunt trips

Function: remote opening of the device when a voltage is applied. Suitable for MCBs S 200 series and RCBOs DS 200 series.

Rated voltage	Order details		Bbn	Price	Price	Weight	Pack
	Type code	Order code	4016779	1 piece	group	1 piece	unit
			EAN			kg	pc.
AC/DC 12...60 V	S2C-A1	2CDS200909R0001	570992			0.15	1
AC 110...415 V/ DC 110...250 V	S2C-A2	2CDS200909R0002	571005			0.15	1

Function: remote opening of the device when a voltage is applied. Suitable for RCCBs F 200 series and RCBOs DS201 and DS202C.

It can be used with MCBs SN201 series by means of SN201-IH interface module.

Rated voltage	Order details		Bbn	Price	Price	Weight	Pack
	Type code	Order code	8012542	1 piece	group	1 piece	unit
			EAN			kg	pc.
AC/DC 12...60V	F2C-A1	2CSS200933R0011	974901			0.15	1
AC 110...415V / DC 110...250V	F2C-A2	2CSS200933R0012	975007			0.15	1



2CSC400471 F0201



2CSC400013 F0202



2CSC400325F0201

Undervoltage releases

Function: protection of the load in the event of a voltage drop (between 70% and 35% of its rated value); positive safety (device's tripping when the voltage is disconnected) emergency stop by means of a button. Suitable for MCBs S 200 series, RCCBs F200 series and RCBOs DS201, DS202C, DS 200 series It can be used with MCBs SN201 series by means of SN201-IH interface module.

Rated voltage	Order details		Bbn 8012542	Price 1 piece	Price group	Weight 1 piece kg	Pack unit pc.
	Type code	Order code	EAN				
12VDC	S2C-UA 12 DC	2CSS200911R0001	839705			0.09	1
24VAC	S2C-UA 24 AC	2CSS200911R0002	839804			0.09	1
24VDC	S2C-UA 24 DC	2CSS200911R0007	896401			0.09	1
48VAC	S2C-UA 48 AC	2CSS200911R0003	839903			0.09	1
48VDC	S2C-UA 48 DC	2CSS200911R0008	896500			0.09	1
110VAC	S2C-UA 110 AC	2CSS200911R0004	840008			0.09	1
110VDC	S2C-UA 110 DC	2CSS200911R0009	896609			0.09	1
230VAC	S2C-UA 230 AC	2CSS200911R0005	840107			0.09	1
230VDC	S2C-UA 230 DC	2CSS200911R0010	896708			0.09	1
400VAC	S2C-UA 400 AC	2CSS200911R0006	840206			0.09	1



2CSC400677F0001

Overvoltage releases

Function: monitoring voltage between the neutral and phase; when an overvoltage reaches the threshold value, the OVP device causes the tripping of the associated MCB or RCCB. Suitable for MCBs of the S200 series up to 63 A, and RCCBs of the F200 series up to 100 A and RCBOs DS201 and DS202C series.

Description	Order details		Bbn 8012542	Price 1 piece	Price group	Weight 1 piece kg	Pack unit pc.
	Type code	Order code	EAN				
Overvoltage release (max tripping voltage AC: 275V)	S2C-OVP1	2CSS200910R0005	748137			0.100	1/5
Overvoltage release (max tripping voltage AC: 290V)	S2C-OVP2	2CSS200993R0005	952039			0.100	1/5



2CSC400055F0201

Hand operated neutral

The hand operated neutral has to be mounted to the left side of the MCB and be snapped on the DIN rail. It is used for measuring duties where the neutral conductor must be in the open position. Due to the special design of the handle - when switching ON the MCB - the neutral will make before the MCB is closed.

The S2C - Nt is not to switch with a tool (screw driver).

Description	Order details		Bbn 4016779	Price 1 piece	Price group	Weight 1 piece kg	Pack unit pc.
	Type code	Order code	EAN				
Max 40A	S2C-Nt	2CDS200918R0001	647625			0.06	1

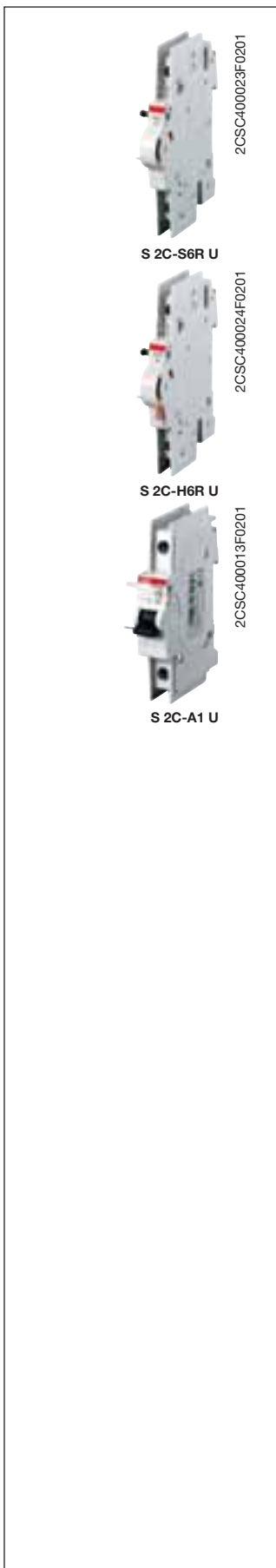

Accessories for S 200 U and S 200 UP acc. UL 489 and CSA-22.2 No. 5

Auxiliary contact (switch)

only for range U and UP	S 2C-H6R U	2CDS 200 914 R0001	61561 7	0.035	1
-------------------------	-------------------	--------------------	----------------	-------	---

Signal contact (bell alarm)

only for range U and UP	S 2C-S6R U	2CDS 200 924 R0001	64677 2	0.035	1
-------------------------	-------------------	--------------------	----------------	-------	---

Shunt trip only for range U and UP

12 - 60 V AC/DC	S 2C-A1 U	2CDS 200 908 R0001	64472 3	0.15	1
110-415 V AC, 110-250V DC	S 2C-A2 U	2CDS 200 908 R0002	64473 0	0.15	1



2CSC400573F0201

Mechanical tripping device

Function: it causes the automatic tripping of the circuit-breakers which it is associated to, when the panel or the door of the electrical switchboard are opened or removed.
Suitable for MCBs S 200 series (on both sides of the devices) and for DS 200 (only on the right side, because on the left side there's RCD-block DDA 200).

Description	Order details	Bbn	Price	Price	Weight	Pack
	Type code	Order code	1 piece	group	1 piece	unit
					kg	pc.
Mechanical tripping device	S2C-BP	2CSS200998R0001	941309		0.048	1



2CSC400568F0201

Plug-in base

Function: it is possible to transform a standard circuit-breaker of the S 200 and F 200 range in a plug-in device which can be pulled out of the circuit where it is installed in one operation.
Suitable for MCBs S 200 series and for RCCBs F 200 series up to 63 A and RCBOs DS201 and DS202C.

Plug-in base	S2C-EST	2CSS200999R0001	940708		0.115	1
--------------	----------------	-----------------	---------------	--	-------	---

4



Motor operating devices

Function: S2C-CM, F2C-CM and DS2C-CM allow the remote control (opening or closing) of the coupled device. Suitable for S200 MCBs up to 63 A, F 200 RCCBs up to 100 A and RCBOs DS201 and DS202C.

Description	Order details	Order code	Bbn	Price 1 piece	Price group	Weight 1 piece kg	Pack unit pc.
	Type code		8012542				
Motor operating device for 1P S200 MCBs	S2C-CM1	2CSS201997R0013	026259			0,166	1
Motor operating device for 2P and 3P S200 MCBs	S2C-CM2/3	2CSS203997R0013	026358			0,166	1
Motor operating device for 4P S200 MCBs	S2C-CM4	2CSS204997R0013	026457			0,166	1
Motor operating device for 2P and 4P F200 RCCBs	F2C-CM	2CSF200997R0013	026556			0,166	1
Motor operating device for 1P+N and 2P DS201, DS202C RCBOs	DS2C-CM	2CSR201997R0013	135951			0,166	1

Auto-reclosing units

Function: F2C-ARI and F2C-ARI30 allow the auto-reclosing of the coupled device in case of unwanted tripping. Suitable for F 200 RCCBs up to 100 A.

Auto-reclosing unit for 2P and 4P F200 RCCBs	F2C-ARI	2CSF200996R0013	026655			0,166	1
Auto-reclosing unit for 2P and 4P F200 RCCBs (30")	F2C-ARI30	2CSF200995R0013	064350			0,166	1

Home automatic resetting unit (for domestic and similar applications)

Function: recloses the associated residual current device (2-pole RCCBs up to 63 A - 30 mA), only after having checked that there are no effective faults in the the system protected by the RCCB. Suitable for 2-pole RCCB series with 30 mA sensitivity

Home automatic resetting unit	F2C-ARH	2CSF200992R0005	732433			0,200	1
-------------------------------	----------------	-----------------	---------------	--	--	-------	---

Home automatic resetting unit with autotest (for domestic and similar applications)

Function: recloses the associated residual current device (2-pole RCCBs up to 63 A - 30 mA), only after having checked that there are no effective faults in the system protected by RCCB. Suitable for 2-pole RCCB series with 30 mA sensitivity. F2C-ARH-T allows the RCCBs automatic test every six months.

Home automatic resetting unit with RCCBs autotest	F2C-ARH-T	2CSF200991R0005	733232			0,200	1
---	------------------	-----------------	---------------	--	--	-------	---

Wiring diagrams for S2C-CM motor operating devices

Low voltage use: 12...30 V AC, 12...48 V DC

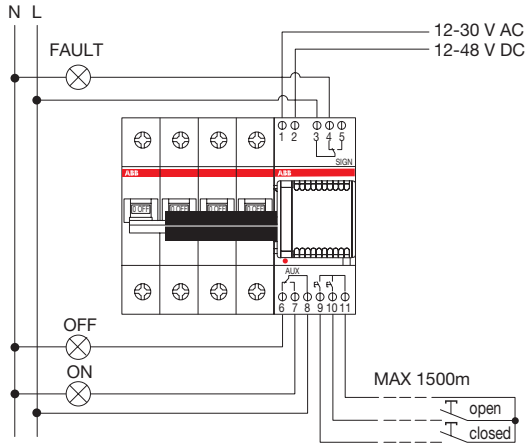

Use at 230 V AC via a TM15/12 bell transformer

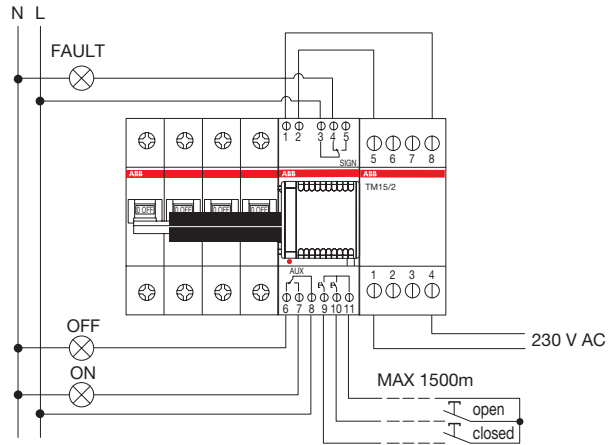

Low voltage use of several motor operating devices: 12...30 V AC, 12...48 V DC

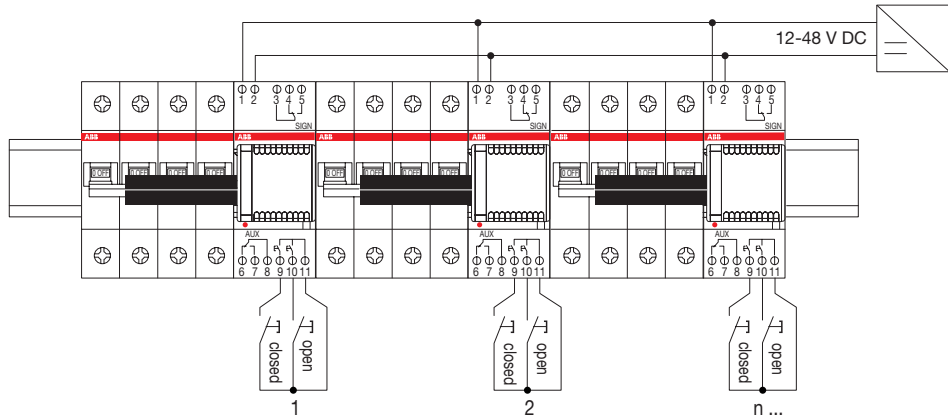

Use of several motor operating devices at 230 V AC via a single safety transformer

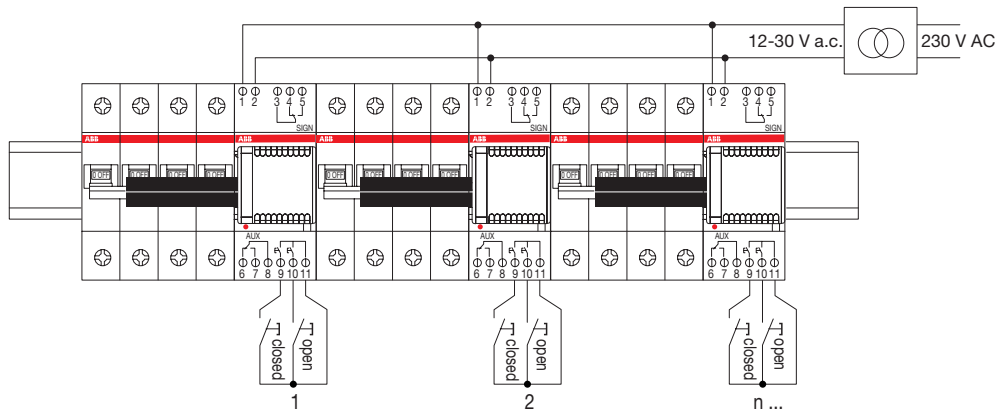

Modular transformer	Secondary voltage	N° max S2C-CM 4 usable
TM15/12	12 V	1
TM15/24	24 V	1
TS16/12	12 V	1
TM30/24	12 V	2
TM30/24	24 V	3
TS 25/12-24 C	12, 24 V	5
TS 40/12-24 C	12, 24 V	6
TS 63/12-24 C	12, 24 V	7

2CSC400015F0202

Wiring diagrams for DS2C-CM motor operating devices

Low voltage use 12...30 V AC, 12...48 V DC

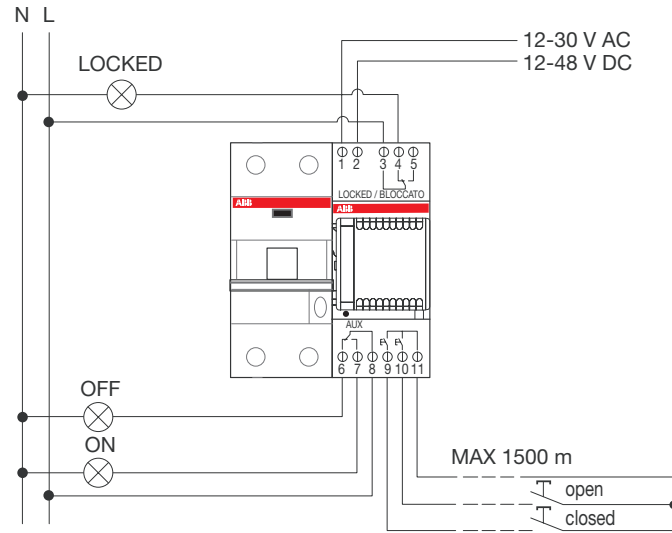

Use at 230 V AC via a TN15/12 transformer

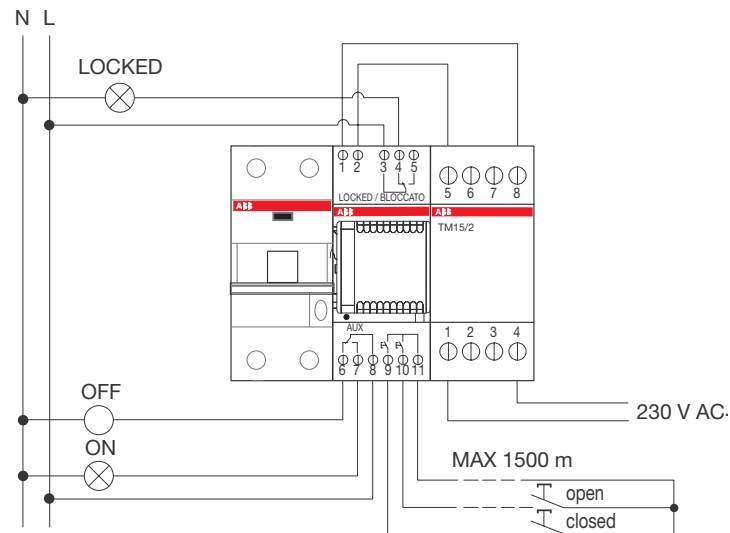

Wiring diagrams for motor operating device F2C-CM and F2C-ARI auto-reclosing unit

Low voltage use: 12...30 V AC, 12...48 V DC

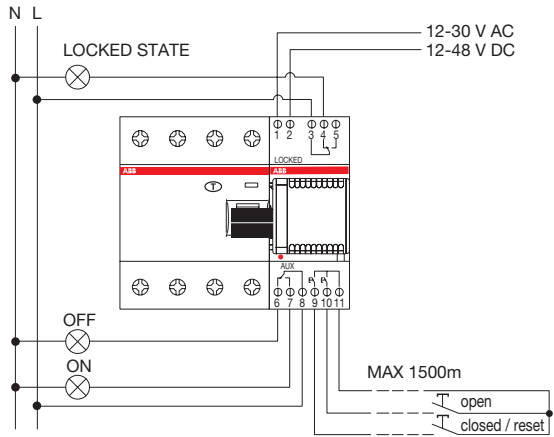

Use at 230 V AC via a TM15/12 bell transformer

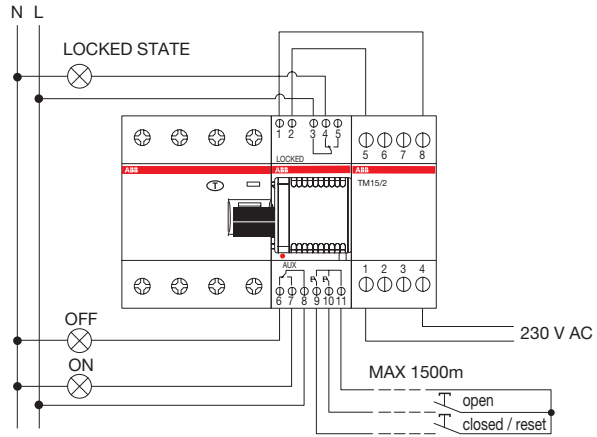

Low voltage use of several motor operating devices or auto-reclosing units: 12-30 V AC, 12-48 V DC

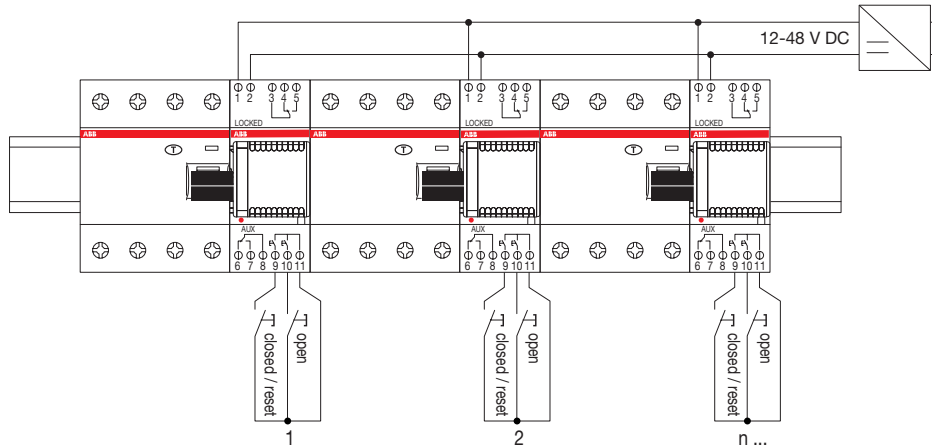

Use of several motor operating devices or auto-reclosing units at 230 V AC via a single transformer

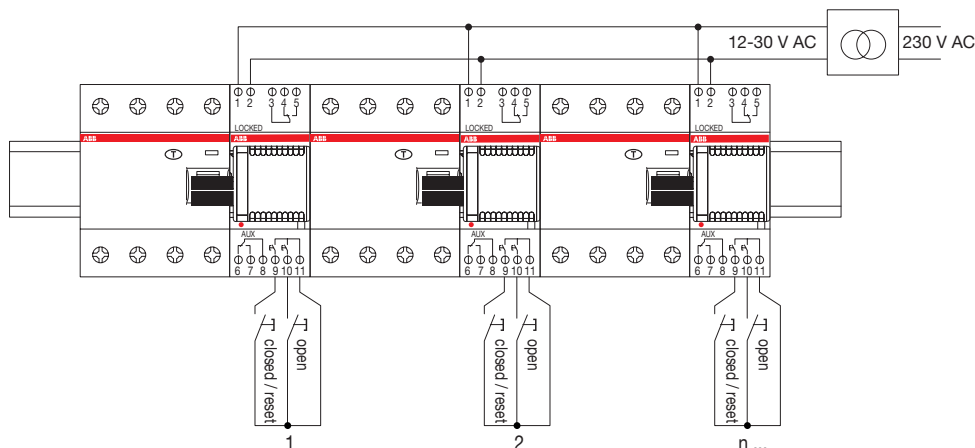

Modular transformer	Secondary voltage	N° max F2C-CM or F2C-ARI usable
TM15/12	12 V	1
TM15/24	24 V	1
TS16/12	12 V	1
TM30/24	12 V	5
TM30/24	24 V	8
TS 25/12-24 C	12, 24 V	10
TS 40/12-24 C	12 V	10
TS 63/12-24 C	12, 24 V	10

2CSC-400016F0202

Wiring diagram for F2C-ARH and F2C-ARH-T

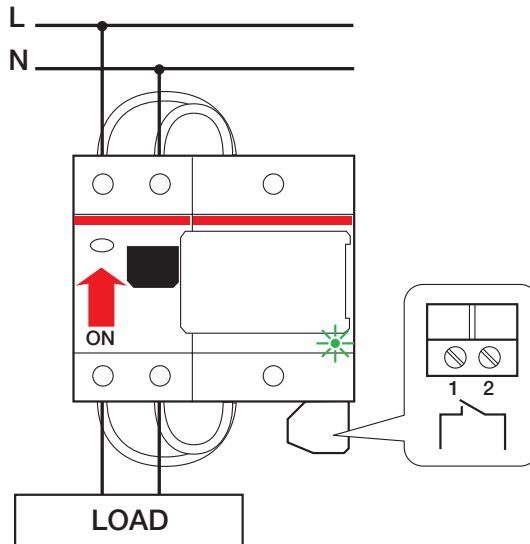

2CSC400017F0202

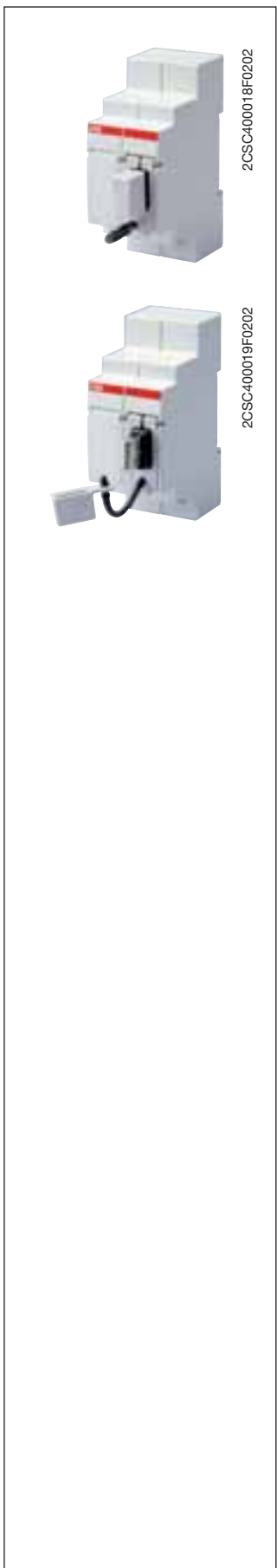

USB Modular DIN rail device

Function: Modular DIN rail device to store electronic information, files and applications. All the data required will be available in the switchboard. No supply is required.

ATTENTION!

MeMo2 is available with built in USB cable. MeMo4 is available with USB port (USB cable not included).

Description	Storage	Order details		Bbn	Price	Price	Weight	Pack
		Type code	Order code	8012542	1 piece	group	1 piece	unit
				EAN			kg	pc.
Modular data memory	2 GB	MeMo2	2CSS200960R0001	128052			0.200	1
Modular data memory	4 GB	MeMo4	2CSS200960R0002	144656			0.200	1

4

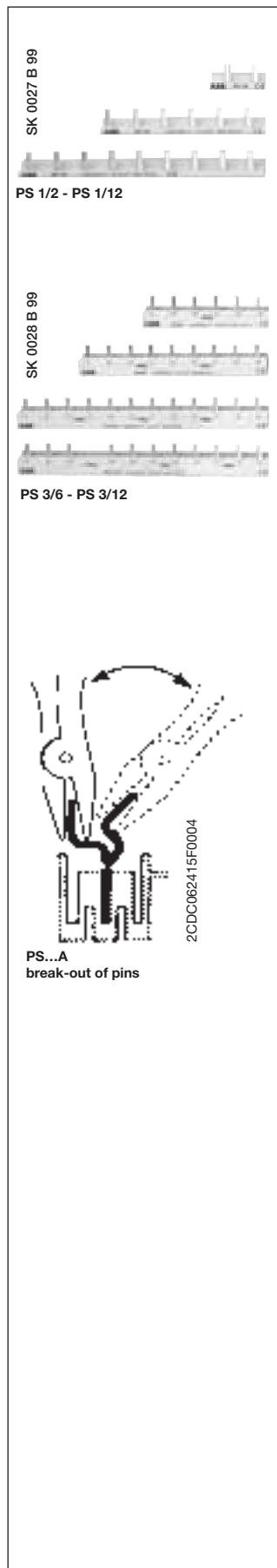

No. of pins	Phases	mm ²	Order details	Bbn 4016779	Price 1 piece	Price group	Cu-No. kg	Weight 1 piece kg	Pack unit pc.
			Type code	Order code	EAN				

Pre-assembled busbars (not to be cut)

1-phase busbars, pin distance 17.6 mm, end caps PS-END 0

2	1	10	PS1/2	2CDL 210 001 R1002	463003		0.01	0.01	180
3	1	10	PS1/3	2CDL 210 001 R1003	514651		0.03	0.03	120
4	1	10	PS1/4	2CDL 210 001 R1004	648233		0.03	0.03	100
6	1	10	PS1/6	2CDL 210 001 R1006	463102		0.03	0.03	60
9	1	10	PS1/9	2CDL 210 001 R1009	463201		0.04	0.04	30
12	1	10	PS1/12	2CDL 210 001 R1012	463300		0.05	0.05	30
12	1	10	PS1/12A ②	2CDL 210 010 R1012	682985		0.05	0.05	30

3-phase busbars, pin distance 17.6 mm

6	3	10	PS3/6	2CDL 231 001 R1006	463409		0.04	0.04	60
9	3	10	PS3/9	2CDL 231 001 R1009	463508		0.07	0.07	30
12	3	10	PS3/12	2CDL 231 001 R1012	463607		0.10	0.10	30
12	3	10	PS3/12FI *	2CDL 231 002 R1012	463706		0.10	0.09	50

* phase sequence: L1, L2, L3, free, L2, L3, L1, ...

Busbars suitable for cutting

1-phase busbars, pin distance 17.6 mm, end caps PS-END 0

60	1	10	PS1/60	2CDL 210 001 R1060	514668		0.26	0.26	20
60	1	10	PS1/60A ②	2CDL 210 010 R1060	682992		0.26	0.28	50
60	1	16	PS1/60/16	2CDL 210 001 R1660	516655		0.41	0.41	20
60	1	16	PS1/60/16A ②	2CDL 210 010 R1660	683005		0.41	0.39	50
5	1	30	PS1/5/30 ①	2CDL 210 001 R3005	653244		0.04	0.04	100
7	1	30	PS1/7/30 ①	2CDL 210 001 R3007	653251		0.06	0.06	100
10	1	30	PS1/10/30 ①	2CDL 210 001 R3010	653268		0.09	0.09	100
11	1	30	PS1/11/30 ①	2CDL 210 001 R3011	653275		0.09	0.10	100
14	1	30	PS1/14/30 ①	2CDL 210 001 R3014	653282		0.120	0.120	50
15	1	30	PS1/15/30 ①	2CDL 210 001 R3015	653299		0.130	0.130	50
18	1	30	PS1/18/30 ①	2CDL 210 001 R3018	653305		0.150	0.150	50
19	1	30	PS1/19/30 ①	2CDL 210 001 R3019	653312		0.160	0.160	50
60	1	30	PS1/60/30	2CDL 210 001 R3060	653596		0.520	0.520	20

1-phase busbars, connection of 1-pole devices with auxiliary, end caps PS-END 0

38	1	10	PS1/38H	2CDL 210 001 R1038	586139		0.27	0.27	30
38	1	16	PS1/38/16H	2CDL 210 001 R1638	586146		0.45	0.45	30

1-phase busbars, connection of neutral (blue insulation), end caps END 1.1

28	1	10	PS1/28N	2CDL 210 001 R1028	629546		0.24	0.14	50
28	1	16	PS1/28/16N	2CDL 210 001 R1628	629560		0.32	0.20	50
57	1	10	PS1/57NA ②	2CDL 210 011 R1057	579728		0.24	0.14	50
57	1	10	PS1/57N	2CDL 210 001 R1057	629539		0.24	0.14	50
57	1	16	PS1/57/16NA ②	2CDL 210 011 R1657	579735		0.32	0.20	50
57	1	16	PS1/57/16N	2CDL 210 001 R1657	629553		0.32	0.20	50

1-phase busbars, connection of auxiliaries, end caps END 1.1 except PS 1/57/6

23	1	6	PS1/23/6	2CDL 210 005 R0623	584739		0.16	0.09	50
29	1	6	PS1/29/6	2CDL 210 005 R0629	580823		0.14	0.10	50
38	1	6	PS1/38/6	2CDL 210 005 R0638	580816		0.14	0.09	50
57	1	6	PS1/57/6	2CDL 210 005 R0657	585309		0.11	0.08	50

① inclusive of end caps
② pre-cutted pins

③ use end cap PS-END 3
④ use end cap PS-END 3.1

⑤ removal of installed MCB not possible

No. of pins	Phases	mm ²	Order details		Bbn 4016779	Price 1 piece	Price group	Cu-No.	Weight 1 piece	Pack unit
			Type code	Order code	EAN			kg	kg	pc.

1-phase busbars, connection of hand operated neutral S2C-Nt (blue insulation), end caps END 1.1

38	1	10	PS1/38 NT	2CDL 210 002 R1038	655361			0.410		10
----	---	----	------------------	--------------------	---------------	--	--	-------	--	----

2-phase busbars, pin distance 17.6 mm, end caps PS-END

12	2	10	PS2/12 ①	2CDL 220 001 R1012	556521			0.07	0.08	50
12	2	10	PS2/12A ①②	2CDL 220 010 R1012	584616			0.07	0.08	50
12	2	16	PS2/12/16	2CDL 220 001 R1612	646918			0.11	0.09	50
58	2	10	PS2/58	2CDL 220 001 R1058	556552			0.32	0.36	10
58	2	16	PS2/58/16	2CDL 220 001 R1658	556569			0.55	0.49	10
58	2	16	PS2/58/16A ②	2CDL 220 010 R1658	584746			0.55	0.49	10
58	2	30	PS2/58/30 ③⑤	2CDL 220 010 R3058	654272			1.81	1.81	10

Note: PS...A is a busbar with removable pin

2-phase busbars, connection of 2-pole devices with auxiliary, end caps PS-END

48	2	10	PS2/48H	2CDL 220 001 R1048	556538			0.47	0.35	10
48	2	16	PS2/48/16H	2CDL 220 001 R1648	556545			0.68	0.48	10
48	2	16	PS2/48/16HA ②	2CDL 220 012 R1648	584630			0.68	0.48	10

3-phase busbars, pin distance 17.6 mm, end caps PS-END

11	3	10	PS3/11 ①	2CDL 230 001 R1011	649926			0.10	0.08	50
12	3	10	PS3/12 ①	2CDL 230 001 R1012	576116			0.09	0.09	50
12	3	10	PS3/12A ①②	2CDL 230 010 R1012	584647			0.09	0.09	50
12	3	16	PS3/12/16 ①	2CDL 230 001 R1612	562805			0.16	0.12	50
60	3	10	PS3/60	2CDL 230 001 R1060	514699			0.51	0.47	10
60	3	10	PS3/60A ②	2CDL 230 010 R1060	563758			0.51	0.47	10
60	3	16	PS3/60/16	2CDL 230 001 R1660	514705			0.76	0.65	10
60	3	16	PS3/60/16A ②	2CDL 230 010 R1660	563765			0.76	0.65	10
60	3	30	PS3/60/30 ③⑤	2CDL 230 001 R3060	654289			2.65	2.65	10

3-phase busbars, connection of 1-pole devices with auxiliary, end caps PS-END

39	3	10	PS3/39H	2CDL 230 001 R1039	556590			0.51	0.43	10
39	3	16	PS3/39/16H	2CDL 230 001 R1639	556606			0.76	0.60	10

3-phase busbars, connection of 2-pole devices (Phase+N) with auxiliary, end caps PS-END

24	3	10	PS3/24H	2CDL 230 001 R1024	556576			0.80	0.41	10
----	---	----	----------------	--------------------	---------------	--	--	------	------	----

3-phase busbars, connection of 2-pole devices (Phase+Phase) with auxiliary, end caps PS-END

46	3	16	PS3/46/16H-IT	2CDL 230 001 R1646	662109			0.98	0.98	10
----	---	----	----------------------	--------------------	---------------	--	--	------	------	----

3-phase busbars, connection of 3-pole devices with auxiliary, end caps PS-END

48	3	10	PS3/48H	2CDL 230 001 R1048	556613			0.51	0.43	10
48	3	16	PS3/48/16H	2CDL 230 001 R1648	556644			0.76	0.60	10
48	3	16	PS3/48/16HA ②	2CDL 230 012 R1648	584654			0.76	0.60	10

3-phase busbars, connection of 1+N or RCBOs, end caps PS-END

30	3	10	PS3/30	2CDL 230 001 R1030	556583			0.50	0.42	10
----	---	----	---------------	--------------------	---------------	--	--	------	------	----

① inclusive of end caps
② pre-cutted pins

③ use end cap PS-END 3
④ use end cap PS-END 3.1

⑤ removal of installed MCB
not possible

No. of pins	Phases	mm ²	Order details		Bbn 4016779	Price 1 piece	Price group	Cu-No.	Weight 1 piece	Pack unit
			Type code	Order code	EAN			kg	kg	pc.

3-phase busbars, N of the RCD omitted, end caps PS-END

9	3	10	PS3/9FI ①	2CDL 230 002 R1009	517515			0.10	0.06	50
10	3	10	PS3/10FI ①	2CDL 230 002 R1010	517522			0.10	0.07	50
12	3	10	PS3/12FI ①	2CDL 230 002 R1012	571074			0.11	0.09	50
57	3	10	PS3/57FI	2CDL 230 002 R1057	556651			0.55	0.46	10

3-phase busbars, N of the RCD omitted, with auxiliary at RCD end caps PS-END

12	3	10	PS3/12FIH ①	2CDL 230 003 R1012	571081			0.11	0.09	50
----	---	----	--------------------	--------------------	---------------	--	--	------	------	----

4-phase busbars, pin distance 17.6 mm, end caps PS-END 1

12	4	10	PS4/12 ①	2CDL 240 101 R1012	656054			0.12	0.11	30
12	4	10	PS4/12A ①②	2CDL 240 110 R1012	656061			0.12	0.11	30
12	4	16	PS4/12/16 ①	2CDL 240 101 R1612	656078			0.24	0.16	30
60	4	10	PS4/60	2CDL 240 101 R1060	656085			0.80	0.64	10
60	4	16	PS4/60/16	2CDL 240 101 R1660	656092			1.21	0.89	10
60	4	16	PS4/60/16A ②	2CDL 240 110 R1660	656108			1.21	0.89	10
60	4	30	PS4/60/30 ④⑤	2CDL 240 001 R3060	654296			3.37	3.37	10

Note: PS...A is a busbar with removable pin

4-phase busbars, connection of 4-pole devices with auxiliary, end caps PS-END 1

52	4	16	PS4/52/16H	2CDL 240 101 R1652	656115			1.30	0.78	10
52	4	16	PS4/52/16HA ②	2CDL 240 212 R1652	656122			1.30	0.78	10

4-phase busbars, connection of 1+N or RCBOs, end caps PS-END 1

12	4	10	PS4/12NA ①②	2CDL 240 213 R1012	656139			0.14	0.10	30
58	4	10	PS4/58N	2CDL 240 101 R1058	656146			0.80	0.59	10
58	4	16	PS4/58/16N	2CDL 240 101 R1658	656153			1.21	0.77	10
58	4	16	PS4/58/16NA ②	2CDL 240 213 R1658	656221			1.21	0.77	10

4-phase busbars, connection of 1+N or RCBOs with auxiliary, end caps PS-END 1

48	4	16	PS4/48/16NHA ②	2CDL 240 114 R1648	656160			1.48	0.76	10
----	---	----	-----------------------	--------------------	---------------	--	--	------	------	----

4-phase busbars, connection of 4-pole RCD with 1+N , end caps PS-END 1

58	4	10	PS4/58NNA ②	2CDL 240 110 R1058	656177			0.80	0.58	10
58	4	16	PS4/58/16NNA ②	2CDL 240 110 R1658	656184			1.21	0.80	10

① inclusive of end caps
② pre-cutted pins

③ use end cap PS-END 3
④ use end cap PS-END 3.1

⑤ removal of installed MCB not possible



PS2/6/16 BP

2CDC06100750010



BSK BP

2CDC 061 095 F0007



AST35/15BP

2CDC061002S0010



SZ-ESK BP

2CDC061003S0010

No. of pins	Phases	mm ²	Order details		Bbn 4016779	Price 1 piece	Price group	Cu-No.	Weight 1 piece	Pack unit
			Type code	Order code	EAN			kg	kg	pc.

Pre-assembled busbars (not to be cut) UL 489

1-phase busbars, pin distance 17.6 mm, UL 489

6	1	16	PS 1/6/16 BP	2CDL 210 489 R1606	644969			0.04	0.05	1
12	1	16	PS 1/12/16 BP	2CDL 210 489 R1612	644976			0.07	0.11	1
18	1	16	PS 1/18/16 BP	2CDL 210 489 R1618	644983			0.11	0.16	1

2-phase busbars, pin distance 17.6 mm, UL489

6	2	16	PS 2/6/16 BP	2CDL 220 489 R1606	644990			0.07	0.06	1
12	2	16	PS 2/12/16 BP	2CDL 220 489 R1612	645003			0.14	0.13	1
18	2	16	PS 2/18/16 BP	2CDL 220 489 R1618	645010			0.21	0.20	1

3-phase busbars. pin distance 17.6 mm. UL 489

6	3	16	PS 3/6/16 BP	2CDL 230 489 R1606	645027			0.11	0.07	1
12	3	16	PS 3/12/16 BP	2CDL 230 489 R1612	645034			0.22	0.15	1
18	3	16	PS 3/18/16 BP	2CDL 230 489 R1618	645041			0.33	0.24	1

Shock-protection caps for PS...BP (UL 489)

3 parts	BSK BP	2CDL 200 489 R0001	656368					0.001	10
---------	--------	--------------------	--------	--	--	--	--	-------	----

Conn. capacity mm ²	Order details		Bbn 4016779	Price 1 piece	Price group	Cu-No.	Weight 1 piece	Pack unit
	Type code	Order code	EAN			kg	kg	pc.

Feeder Terminals for PS...BP (UL 489)

Terminal, insulated with pin contact

35	AST 35/15 BP	2CDL 201 489 R3515	710350			0.035	0.035	25
----	--------------	--------------------	--------	--	--	-------	-------	----

Feeder Terminal

single-pole terminal, can be mounted side by side, feed on the pin of the busbar

50	SZ-ESK BP	2CDL 201 489 R5001	710367			0.038	50
----	-----------	--------------------	--------	--	--	-------	----

- ① inclusive of end caps
- ② pre-cutted pins

- ③ use end cap PS-END 3
- ④ use end cap PS-END 3.1

- ⑤ removal of installed MCB not possible

Technical features

Feeder terminals SZ-ESK BP / AST 35/15 BP

Max. operating voltage		480 VAC
Max. current		115 A ¹⁾
Protection degree		IP 20
Wire range	SZ-ESK PB	35 mm ² finely stranded with ferrule 50 mm ² solid/stranded
	AST 35/15 BP	25 mm ² finely stranded with ferrule 35 mm ² solid/stranded

1) regardless of the rated current of the feeder terminal the maximum current rating of the device terminal may not be exceeded

No. of pins	Phases	mm ²	Order details	Bbn	Price	Price	Cu-No.	Weight	Pack
			Type code	Order code	4016779	1 piece	group	1 piece	unit
					EAN		kg	kg	pc.

Busbars (suitable for cutting) UL 1077

1-phase busbars, pin distance 17.6 mm, end caps PS-END 0

60	1	10	PS 1/60 SP	2CDL 210 111 R1060	830409			0.26	0.26	20
60	1	16	PS 1/60/16 SP	2CDL 210 111 R1660	830423			0.41	0.41	20

1-phase busbars, connection of 1-pole devices with auxiliary, PS-END 0

38	1	10	PS 1/38H SP	2CDL 210 111 R1038	830430			0.27	0.27	30
38	1	16	PS 1/38/16H SP	2CDL 210 111 R1638	830447			0.45	0.45	30

2-phase busbars, pin distance 17.6 mm, end caps PS-END SP

58	2	10	PS 2/58 SP	2CDL 220 111 R1058	646413			0.42		10
58	2	16	PS 2/58/16 SP	2CDL 220 111 R1658	646420			0.69		10

2-phase busbars, connection of 2-pole devices with auxiliary, end caps PS-END SP

48	2	16	PS 2/48/16 SP	2CDL 220 112 R1648	646437			0.68		10
----	---	----	---------------	--------------------	--------	--	--	------	--	----

3-phase busbars, pin distance 17.6 mm, end caps PS-END SP

60	3	10	PS 3/60 SP	2CDL 230 111 R1060	646444			0.68		10
60	3	16	PS 3/60/16 SP	2CDL 230 111 R1660	646451			1.02		10

3-phase busbars, connection of 3-pole devices with auxiliary, end caps PS-END SP

48	3	16	PS 3/48/16 SP	2CDL 230 112 R1648	646468			1.16		10
----	---	----	---------------	--------------------	--------	--	--	------	--	----

4-phase busbars, pin distance 17.6 mm, PS-END 1 SP

60	4	16	PS 4/60/16 SP	2CDL 240 311 R1660	656191			1.97		10
----	---	----	---------------	--------------------	--------	--	--	------	--	----

4-phase busbars, connection of 4-pole devices with auxiliary, end caps PS-END 1 SP

52	4	16	PS 4/52/16H SP	2CDL 240 312 R1652	656207			1.90		10
----	---	----	----------------	--------------------	--------	--	--	------	--	----

4-phase busbars, connection of 1+N and RCBO, end caps PS-END 1 SP

58	4	16	PS4/58/16N SP	2CDL 240 313 R1658	656214			1.86		10
----	---	----	---------------	--------------------	--------	--	--	------	--	----

Shock-protection caps for PS...SP (UL 1077)

5 parts	BSK SP	2CDL 200 111 R0001	710398				0.001		100
---------	--------	--------------------	--------	--	--	--	-------	--	-----

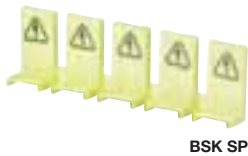

2CDC061006S0010

BSK SP



2CDC061004S0010

AST 35/15 SP



2CDC061006S0010

SZ-ESK SP

Conn. capacity mm ²	Order details	Bbn	Price	Price	Cu-No.	Weight	Pack
	Type code	Order code	4016779	1 piece	group	1 piece	unit
			EAN		kg	kg	pc.

Feeder Terminals for PS...SP (UL 1077)

Terminal, insulated with pin contact

35	AST 35/15 SP	2CDL 200 111 R0001	710398			0.038	0.025	25
----	--------------	--------------------	--------	--	--	-------	-------	----

Feeder Terminal

single-pole terminal, can be mounted side by side, feed on the pin of the busbar

50	SZ-ESK SP	2CDL 200 489 R5001	710381			0.038	0.032	50
----	-----------	--------------------	--------	--	--	-------	-------	----

Technical features

Feeder terminals SZ-ESK SP / AST 35/15 SP

Max. operating voltage		480 VAC
Max. current		115 A ¹⁾
Protection degree		IP 20
Wire range	SZ-ESK SP	35 mm ² finely stranded with ferrule 50 mm ² solid/stranded
	AST 35/15 SP	25 mm ² finely stranded with ferrule 35 mm ² solid/stranded

1) regardless of the rated current of the feeder terminal the maximum current rating of the device terminal may not be exceeded

No. of pins	Phases	mm ²	Order details	Order code	Bbn 4016779 EAN	Price 1 piece	Price group	Cu-No. kg	Weight 1 piece kg	Pack unit pc.
-------------	--------	-----------------	---------------	------------	-----------------------	------------------	----------------	--------------	-------------------------	---------------------

Busbars (suitable for cutting) for DDA 200 and DS 200 – bottom mounting (RCD)

3-phase busbars, connection of DDA 202 and DS 202, end caps PSB-END 3 (phase sequence L1-L2-free-free-L3-L1.....without N)

30	3	10	PS 3/30-DDA 202	2CDL 230 202 R1030	647472			0.97	0.41	10
30	3	16	PS 3/30/16-DDA 202	2CDL 230 202 R1630	647502			1.46	0.55	10

3-phase busbars, connection of DDA 202 and DS 202 with auxiliary, end caps PSB-END 3 (phase sequence L1-L2-aux.(free)-free-free-L3-L1-aux.(free).....without N)

26	3	16	PS 3/26/16H-DDA 202	2CDL 230 202 R1626	648912					
----	---	----	---------------------	--------------------	--------	--	--	--	--	--

4-phase busbars, connection of DDA 204 63 A and DS 204 50 A and 63 A, end caps PSB-END 4 (phase sequence L1-L2-L3-N-free-free-free-free-L1.....)

32	4	10	PS 4/32-DDA 204	2CDL 240 204 R1032	647458			1.41	0.56	10
32	4	16	PS 4/32/16-DDA 204	2CDL 240 204 R1632	647465			2.12	0.77	10

No. of pins	Phases	mm ²	Order details Type code	Order code	Bbn 4016779 EAN	Price 1 piece	Price group	Cu-No. kg	Weight 1 piece kg	Pack unit pc.
-------------	--------	-----------------	----------------------------	------------	-----------------------	------------------	----------------	--------------	-------------------------	---------------------

Busbars (suitable for cutting) for DDA 200 and DS 200 – top side mounting (MCB)

2-phase busbars, connection of DDA 202 and DS 202, end caps PSB-END 3
(phase sequence L1-L2/N-free-free-.....)

30	2	16	PS 2/30/16N-DDA 202T	2CDL 020 202 R1630	697675			0.512	10
----	---	----	----------------------	--------------------	--------	--	--	-------	----

3-phase busbars, connection of DDA 202 and DS 202, end caps PSB-END 3
(phase sequence L1-L2-free-free-L3-L1.....without N)

30	3	16	PS 3/30/16-DDA 202T	2CDL 033 202 R1630	652629			1.25	10
----	---	----	---------------------	--------------------	--------	--	--	------	----

3-phase busbars, connection of DDA 202 and DS 202 with auxiliary, end caps PSB-END 3
(phase sequence L1-L2-aux.(free)-free-free-L3-L1-aux.(free).....without N)

28	3	16	PS 3/28/16H-DDA 202T	2CDL 034 202 R1628	652636			1.31	10
----	---	----	----------------------	--------------------	--------	--	--	------	----

4-phase busbars, connection of DDA 202 and DS 202, end caps PSB-END 4
(phase sequence L1-N-free-free-L2-N...)

30	4	16	PS 4/30/16N-DDA 202T	2CDL 040 202 R1630	652852			1.67	10
----	---	----	----------------------	--------------------	--------	--	--	------	----

4-phase busbars, connection of DDA 202 and DS 202 with auxiliary, end caps PSB-END 4
(phase sequence L1-N-aux.(free)-free-free-L2-N-aux.(free)...))

30	4	16	PS 4/30/16NH-DDA 202T	2CDL 041 202 R1630	652599			1.72	10
----	---	----	-----------------------	--------------------	--------	--	--	------	----

4-phase busbars, connection of DDA 204 25 A and 40 A and DS 204 up to 40 A,
end caps PSB-END 4
(phase sequence L1-L2-L3-N-free-free-L1.....)

40	4	16	PS 4/40/16-DDA 204T	2CDL 040 204 R1640	652605			1.79	10
----	---	----	---------------------	--------------------	--------	--	--	------	----

4-phase busbars, connection of DDA 204 25 A and 40 A and DS 204 up to 40 A with auxiliary, end caps PSB-END 4
(phase sequence L1-L2-L3-N-aux.(free)-free-free-free-free-L1)

36	4	16	PS 4/36/16H-DDA 204T	2CDL 041 204 R1636	652612			1.73	10
----	---	----	----------------------	--------------------	--------	--	--	------	----



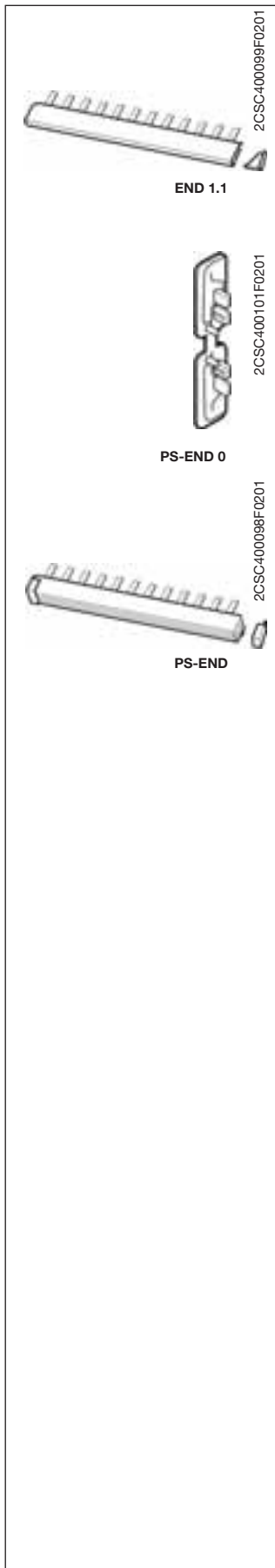

Conn. capacity mm ²	Module	Phases	Order details Type code	Order code	Bbn 4016779 EAN	Price 1 piece	Price group	Weight 1 piece kg	Pack unit pc.
-----------------------------------	--------	--------	----------------------------	------------	-----------------------	------------------	-------------	-------------------------	------------------

End caps

			END 1.1	2CDL 200 011 R0011	638913			0.001	50
			PS-END 0	2CDL 200 001 R0004	652261			0.001	50
			PS-END	2CDL 200 001 R0001	514729			0.001	50
			PS-END 1	2CDL 200 001 R0002	570114			0.001	50
			PS-END SP	2CDL 200 110 R0001	646505			0.001	50
			PS-END 1 SP	2CDL 200 110 R0002	646512			0.001	50
			PS-END 3	2CDL 200 001 R3001	654302			0.001	50
			PS-END 3.1	2CDL 200 001 R3002	654319			0.001	50
			PSB-END 3	GHV0 361 325 R0001	556304 ①			0.001	50
			PSB-END 4	GHV0 361 325 R0002	556403 ①			0.001	50

① bbn-No. 4012233

System pro M compact®

Selection tables

Busbars and accessories for MCBs S 200,
SN 201, RCDs F 200 and DS 200 series

Accessories S 200, SN 201, F 200, DS 200 and other series

PS 1/...
PS 1/.../16
PS 1/.../30

2CDC062166F0003

PS 1/29/6

2CDC062389F0003

PS 3/...
(2CDL 231 ...)

2CDC062021F0004

PS 1/38/6

2CDC062390F0003

PS 3/39 H
PS 3/39/16 H

s0061z02

PS 1/57/6 H
(integrierter
Hilfskontakt)

2CDC062527F0003

PS 1/38 H
PS 1/38/16 H

2CDC062528F0003

PS 2/12
PS 2/58
PS 2/58/16
PS 2/12 A
PS 2/58/16 A
PS 2/58 SP
PS 2/58/16 SP

2CSC400010F0202

PS 1/38 NT

2CDC062148F0008

PS 2/48 H
PS 2/48/16 H
PS 2/48/16 HA
PS 2/48/16 SP

s0059z02

PS 1/23/6

2CDC062019F0004

PS 3/46/16 H-IT

2CDC062092F0007

PS 3/12
PS 3/12 A
PS 3/12/16
PS 3/60
PS 3/60/16
PS 3/60/30
PS 3/60 A
PS 3/60/16 A
PS 3/60 SP
PS 3/60/16 SP

L1 L2 L3 L1 L2 L3

s0060z02

PS 4/48/16 NH A

L1 L2 L3 L1 L2 L3

2CDC062530F0003

PS 3/48 H
PS 3/48/16 H
PS 3/48/16 HA
PS 3/48/16 SP

L1 L2 L3 L1 L2 L3

s0062z02

PS 4/58/ NN A
PS 4/58/16 NN A

L1 L2 L3 L1 L2 L3 L1 L2 L3 L1 L2 L3

PS 3/12 E 463

L1 L2 L3 L1 L2 L3

s0023z01

Example for overlap

PS 3/6
PS 3/12

s0250z02

PS 4/12
PS 4/12/16
PS 4/60
PS 4/60/16
PS 4/12 A
PS 4/60/16 A
PS 4/60/16 SP

L1 L2 L3 N L1 L2 L3

s0063z02

PS 4/52/16 H
PS 4/52/16 HA
PS 4/52/16 SP

L1 L2 L3 N L1 L2 L3

s0056z02

PS 4/12 NA
PS 4/58 N
PS 4/58/16 N
PS 4/58/16 NA
PS 4/58/16 N SP

L1 L2 L3 N L1 L2 L3

SK00665z02

PS 3/30-DDA 202
PS 3/30/16-DDA 202 DS 202 + DS 202 + (DDA 202 + S 202) + (DDA 202 + S 202) ...

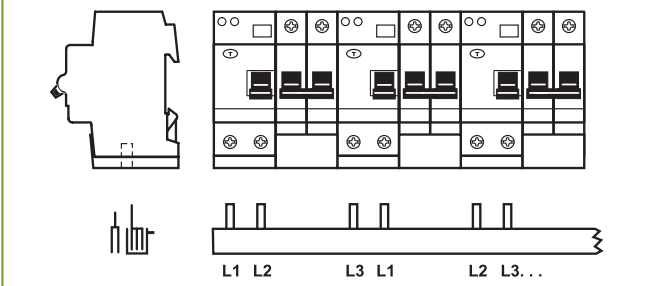

PS 2/30/16N-DDA 202T
DS 202 + DS 202 + (DDA 202 + S 202) ...

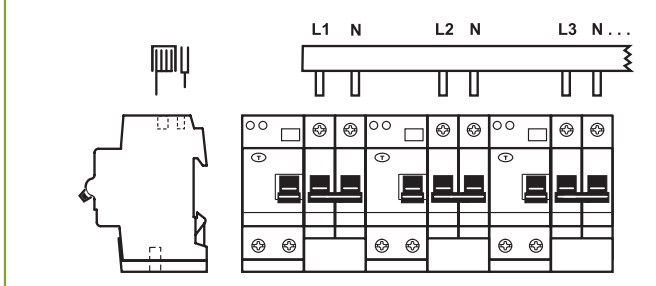

PS 3/26/16H-DDA 202
DS 202 + S2C-S/H6R + DS 202 + S2C-S/H6R + DDA 202
+ S 202 + S2C-S/H6R + DDA 202 + S 202 + S2C-S/H6R ...

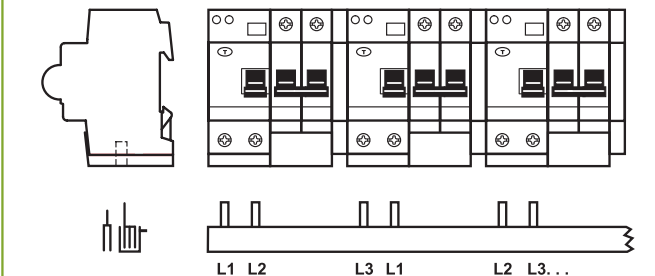

PS 4/30/16N-DDA 202 T
DS 202 + DS 202 + (DDA 202 + S 202) ...

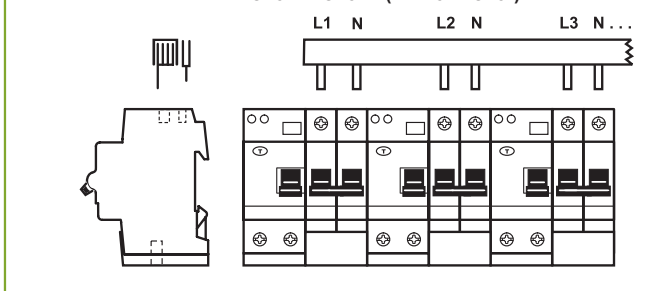

PS 4/32-DDA 204 **PS 4/32/16-DDA 204**
DS 204 (50/63 A) + (DDA 204 (63 A) + S 204) ...

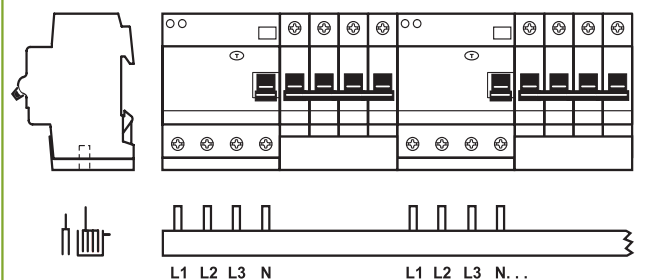

PS 4/30/16NH-DDA 202 T
DS 202 + S2C-S/H6R + DS 202 + S2C-S/H6R + (DDA 202 + S 202)
+ S2C-S/H6R + (DDA 202 + S 202) + S2C-S/H6R ...

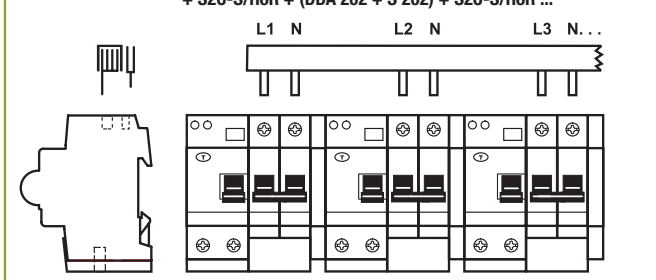

PS 3/30/16-DDA 202 T
DS 202 + DS 202 + DA 202 + S 202 + DDA 202 + S 202 ...

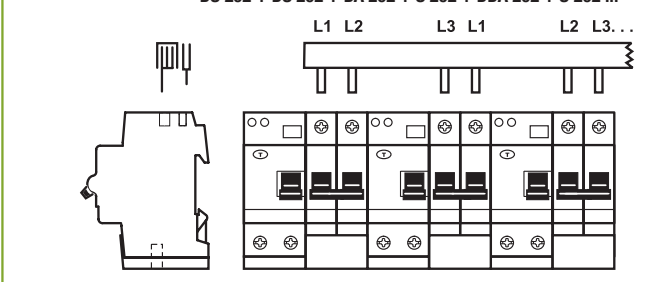

PS 4/40/16-DDA 204 T
DS 204 (≤ 40 A) + DS 204 (≤ 40 A) + DDA 204 (≤ 40 A) + S 204
+ DDA 204 (≤ 40 A) + S 204 ...

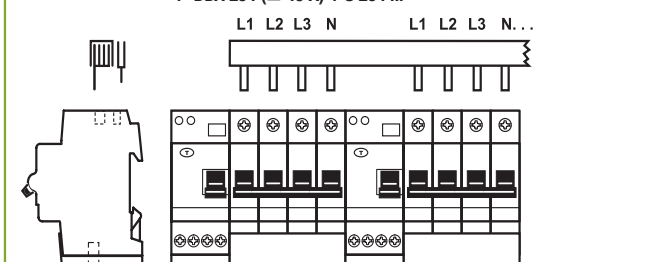

PS 3/28/16 H-DDA 202 T
DS 202 + S2C-S/H6R + (DDA 202 + S 202) + S2C-S/H6R ...

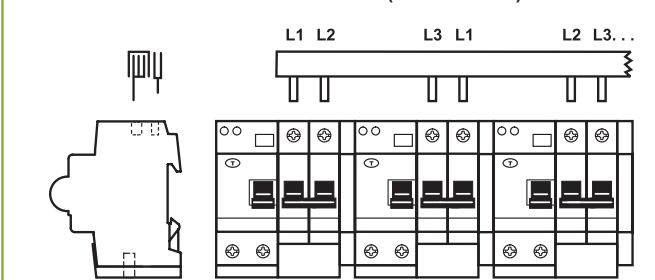

PS 4/36/16 H-DDA 204 T
DS 204 (≤ 40 A) + S2C-S/H6R + DS 204 (≤ 40 A) + S2C-S/H6R
+ DDA 204 (≤ 40 A) + S 204 + S2C-S/H6R + DDA 204 (≤ 40 A)
+ S 204 + S2C-S/H6R

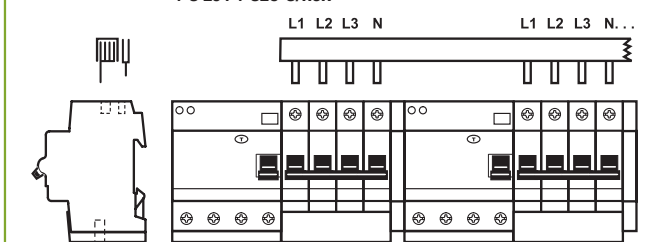

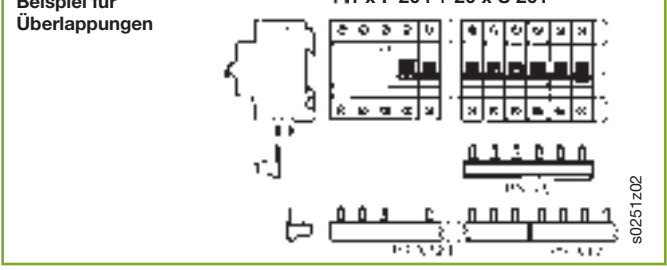
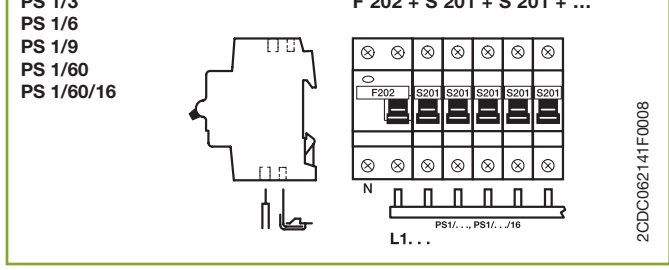
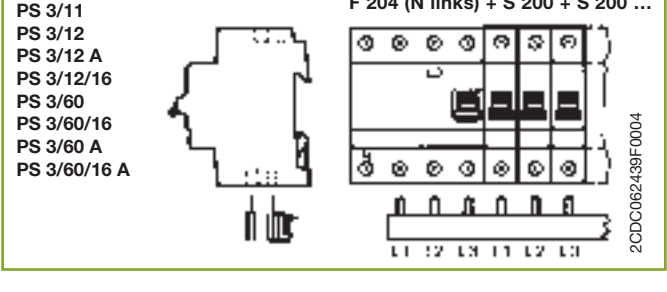
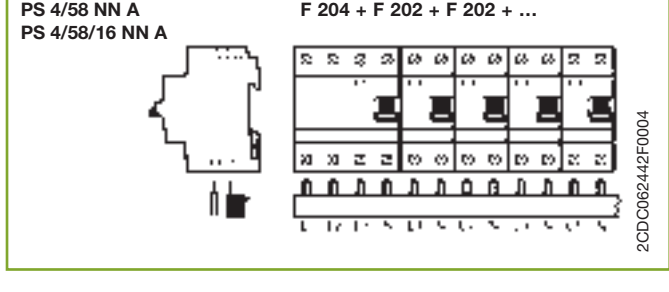
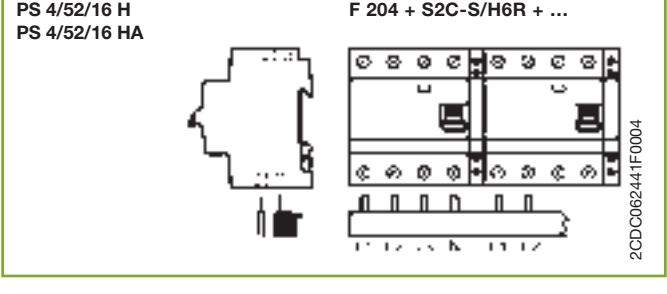
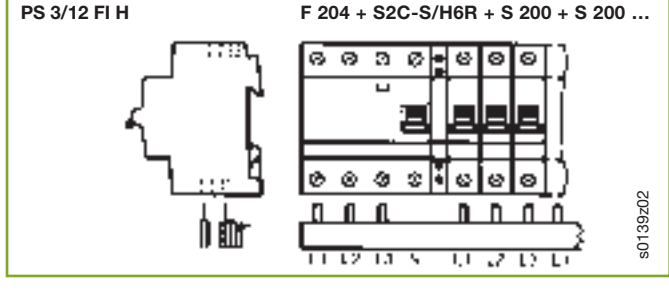
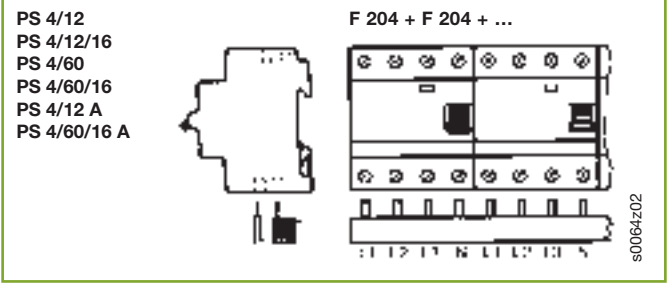
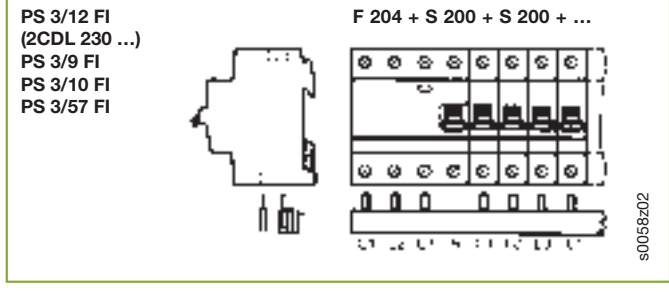
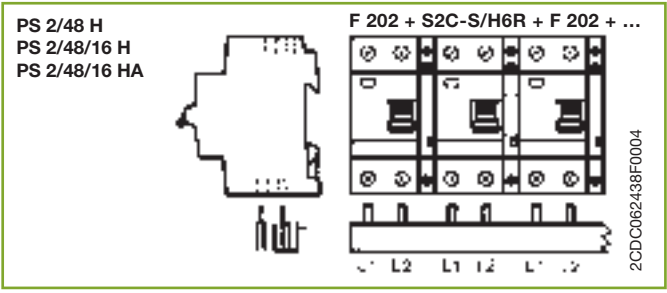
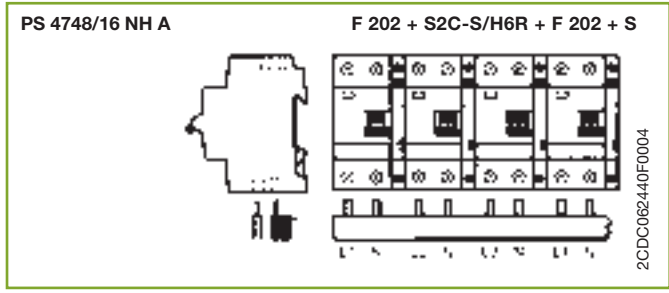
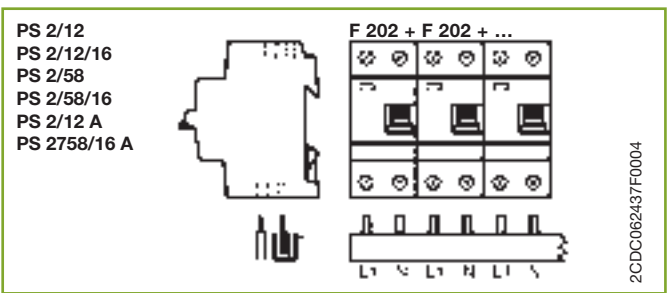
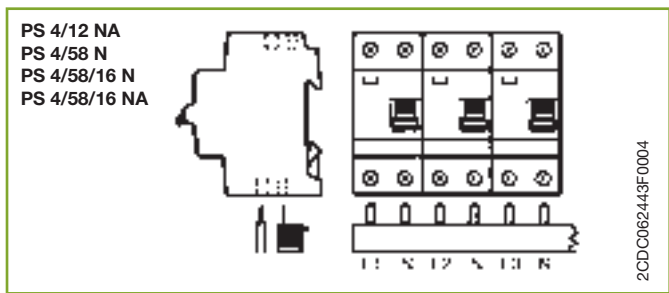

System pro M compact®

Selection tables

Busbars and accessories for MCBs S 200,
SN 201, RCDs F 200 and DS 200 series

Accessories S 200, SN 201, F 200, DS 200 and other series

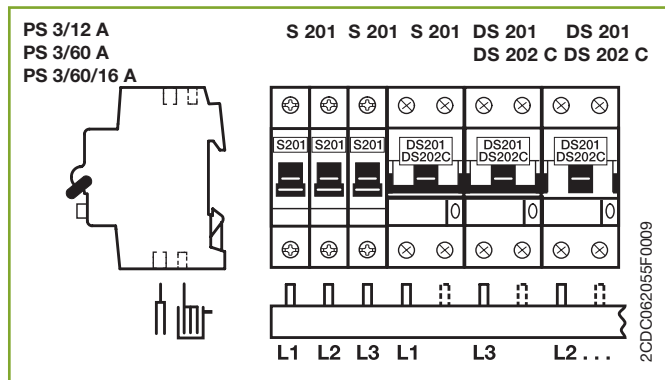
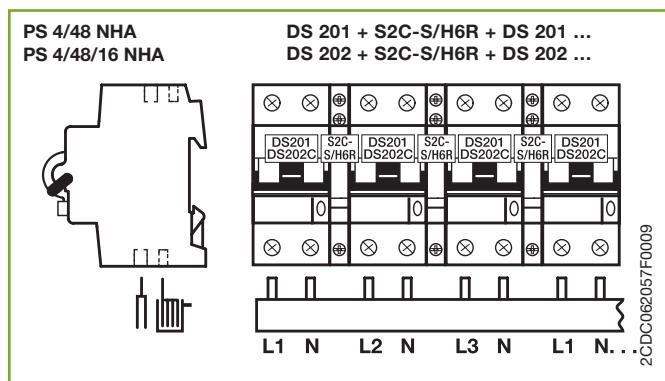
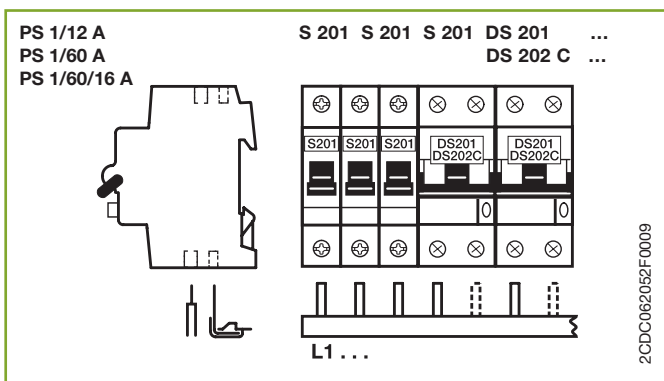
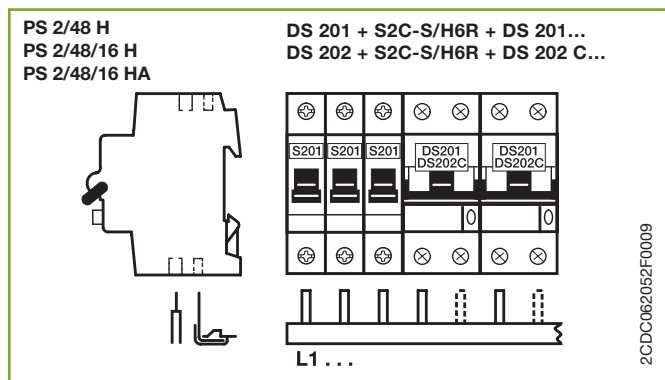
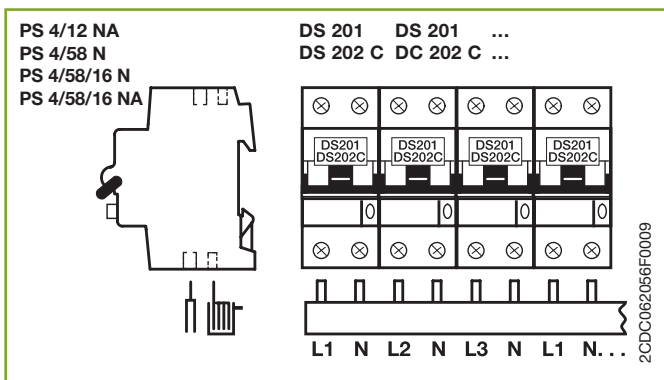
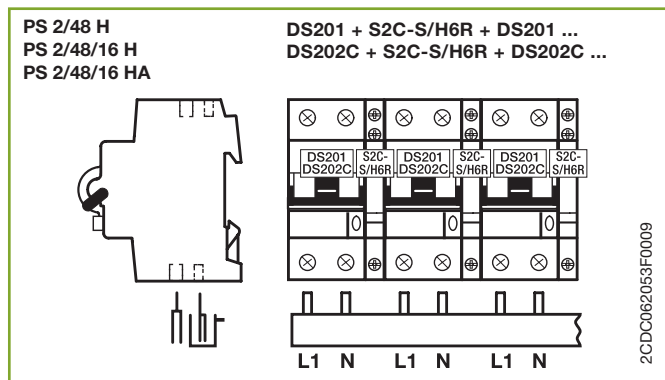
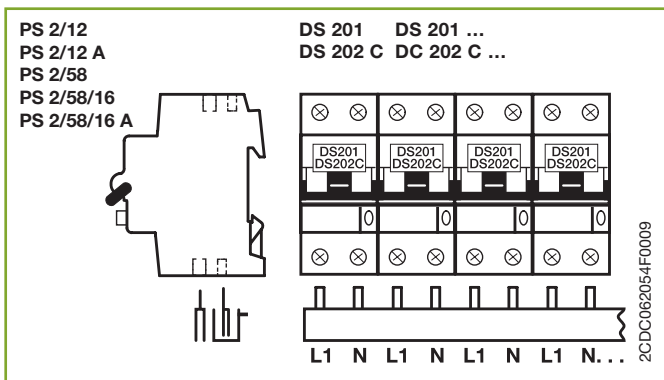

4



Rail connectors

For wiring of component rails in the consumer unit, rail-to-rail clearance 125 mm. In the case of the 4-pole connector, the color of the N conductor is blue.

10	3-pole	RV 3	GH V036 0504 R0023	512381	0.080	25
10	4-pole	RV 4	GH V036 0504 R0024	512244	0.114	25

Auxiliary contact bridge for bottom-fitting auxiliary contacts

Wire jumper for integrated auxiliary contact (MCB S200 H or auxiliary contacts S2C-H01/S2C-H10) for series connections (HKB) or parallel connections (HKB1).

1/2 mod.	HKB	GH V036 0504 R0100	523134	0.001	1000
1 mod.	HKB 1	GH V036 0504 R0101	524209	0.001	1000

Shock-protection caps for PS...

5 parts	SZ-BSK	2CDL 200 001 R0011	420006	0.003	10
5 parts	BSK*	2CDL 200 001 R0012	649834	0.003	10

* closed version

Shock-protection caps for busbars

PS...BP - see page 4/26

PS...SP - see page 4/27

Labelling system

Package comes with 40 labels, marked or blank. Blank labels can be labeled by hand with an indelible, waterproof pen or using a computerised labelling system (plotter).

identification labels blank	BS	GH S200 1946 R0001	478106	0.004	30
identification labels with pictograms	BS Pikto	GH S200 1946 R0002	478205	0.004	30
identification labels marked 4 x 1 – 10	BS 1/10	GH S200 1946 R0003	478304	0.004	30
identification labels marked 2 x 1 – 20	BS 1/20	GH S200 1946 R0004	478403	0.004	30
identification labels marked 1 – 40	BS 1/40	GH S200 1946 R0005	478502	0.004	30
identification labels marked 41 – 80	BS 41 – 80	GH S200 1946 R0006	585910	0.004	30
identification labels marked 81 – 120	BS 81 – 120	GH S200 1946 R0007	585927	0.004	30
identification labels marked 121 – 160	BS 121/160	GH S200 1946 R0008	585934	0.004	30

Identification system ILS

The ILS individual identification system for labels is a DIN A5 polyester film for ink jet and laser printers with high temperature resistance. (If laser printers are used, please check whether self-adhesive film with thickness of 250 µm can be fed.) Adhesive coating 3MTM9471 LE has obtained UL approval (file No. MH 11410). There are two types of sheet: uncut for making individual labels or precut with 23 stripes (6 x 191 mm each) for labelling 11 devices (1-module width) per stripe. Word template can be downloaded from www.abb.de/stotz-kontakt. Can also be used as write-on labels (ink, ballpoint pen, pencil, marker).

1 sheet DIN A5 uncut for laser printer	ILS-L	2CDL 200 002 R0003	663076	0.011	1
1 sheet DIN A5 precut in 23 stripes (6 x 191 mm) for laser printer	ILS-LS	2CDL 200 002 R0004	663083	0.011	1
1 sheet DIN A5 uncut for inkjet printer	ILS-I	2CDL 200 002 R0005	663090	0.011	1
1 sheet DIN A5 precut in 23 stripes (6 x 191 mm) for inkjet printer	IILS-IS	2CDL 200 002 R0006	663106	0.011	1

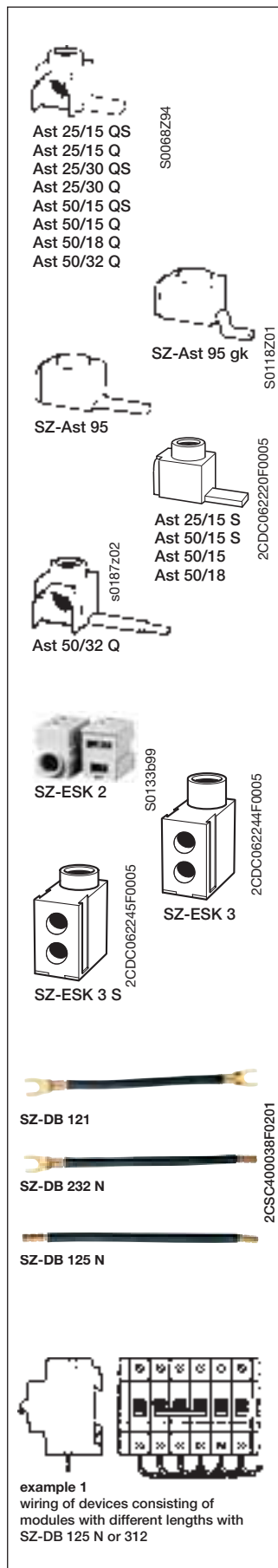

Conn. capacity	Terminal lug	Type of connection	Order details	Bbn	Cu No.	Price	Price	Weight	Pack
mm ²	LxW mm		Type code	Order code	4016779	1 piece	group	1 piece	unit
					EAN			kg	pc.

Terminals, insulated with pin contact

6-25	15/4	90°	Ast 25/15 QS	2CDL200010R2515	656535	0.012			50
6-25	15/4	straight	Ast 25/15 S	2CDL200011R2515	656542	0.012			50
6-25	15/6	90°	Ast 25/15 Q	2CDL200000R2515	656474	0.012			50
6-25	22/4	90°	Ast 25/22 QS	2CDL200010R2522	669436	0.012			50
6-25	30/4	90°	Ast 25/30 QS	2CDL200010R2530	656481	0.012			50
6-25	30/6	90°	Ast 25/30 Q	2CDL200000R2530	656498	0.014			50
6-50	15/4	90°	Ast 50/15 QS	2CDL200000R5015	656504	0.014			50
6-50	15/4	straight	Ast 50/15 S	2CDL200011R5015	656566	0.014			50
6-50	15/7	90°	Ast 50/15 Q	2CDL200010R5015	656559	0.014			50
6-50	15/7	straight	Ast 50/15	2CDL200001R5015	656511	0.014			50
5-50	17.5/7	90°	Ast 50/18 Q	2CDL200100R5018	656580	0.019			50
6-50	17.5/7	straight	Ast 50/18	2CDL200101R5018	656573	0.019			50
6-50	32/6	90°	Ast 50/32 Q	2CDL200000R5032	656528	0.017			50
25-95	21/6.5	straight	SZ-Ast 95 gk*	GHV0360501R0012	522618	0.06		0.067	50
25-95	21/6.5	straight	SZ-Ast 95*	GHV0360501R0013	522625	0.06		0.067	50

Abbreviations: Q terminal 90°
S narrow connection pin
* not for pro M compact

Technical features

Connection capacity	6-25 mm ²	6-50 mm ²	25-95 mm ²
Max. electrical load	63 A	100 A	225 A
Max. operating voltage	600 V AC	600 V AC	690 V AC
Max. tightening torque	2 Nm	3 Nm	19 Nm

Feeder terminals

Single-pole terminals can be mounted side by side with multipole terminals.

6-35	SZ-ESK 2	2CDL200001R3501	646765		0.024	10
6-50	SZ-ESK 3	2CDL200003R5001	652575		0.025	10
6-50	SZ-ESK 3 S	2CDL200003R5003	652889		0.024	10

Flexible connecting wires

with fork-type cable lug (black)

Conn. capacity	Length	Order details	Bbn	Cu No.	Price	Price	Weight	Pack
mm ²		Type code	Order code	4012233	1 piece	group	1 piece	unit
				EAN			kg	pc.
6	125	SZ-DB 121	GH V036 1425 R0001	55650 2	0.006		0.025	1000/50
10	135	SZ-DB 122 N	GH V036 1425 R0031	55670 0	0.010		0.02	500/25
6	260	SZ-DB 231 N	GH V036 1425 R0032	55680 9	0.014		0.02	500/25
10		SZ-DB 232 N	GH V036 1425 R0033	55690 8	0.022		0.04	250/25
10	330	SZ-DB 311	GH V036 1425 R0034	55700 4	0.029		0.05	100/25

with fork-type cable lug and ultrasonic compacted cable ends (black)

6	125	SZ-DB 123	GH V036 1425 R0006	55660 1	0.007		0.01	1000/50
10	135	SZ-DB 124 N	GH V036 1425 R0035	55710 3	0.012		0.02	500/25
6	260	SZ-DB 235	GH V036 1425 R0036	55720 2	0.014		0.02	500/25
10		SZ-DB 236	GH V036 1425 R0037	55730 1	0.024		0.04	250/25

Advantages:

- smaller dimensions for the same cross-section (more space in terminal)
- nearly no transition resistances
- more reliability; conductor sleeves could be loosen under specific conditions

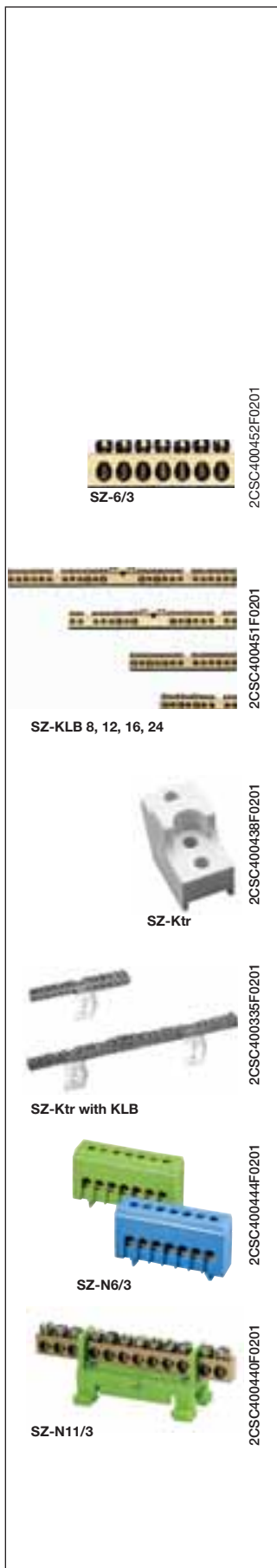

with ultrasonic compacted cable ends (black)

6	125	SZ-DB 125 N	GH V036 1425 R0038	55740 0	0.007	0.01	1000/50
6	260	SZ-DB 233 N	GH V036 1425 R0039	55750 9	0.015	0.02	500/25
10	135	SZ-DB 126 N	GH V036 1425 R0040	55760 8	0.013	0.02	500/25
10	260	SZ-DB 234 N	GH V036 1425 R0041	55770 7	0.025	0.04	250/25
10	330	SZ-DB 312	GH V036 1425 R0042	55780 6	0.032	0.05	100/25

with ultrasonic compacted cable ends (blue)

10	135	SZ-DB 10/135 N	2CDL 200 301 R0135	66352 6	0.013	0.02	25
10	260	SZ-DB 10/260 N	2CDL 200 301 R0260	66353 3	0.025	0.04	25
10	330	SZ-DB 10/330 N	2CDL 200 301 R0330	66354 0	0.032	0.05	25

Advantages:

- smaller dimensions for the same cross-section (more space in terminal)
- nearly no transition resistances
- more reliability; conductor sleeves could be loosen under specific conditions

Input	Output	Order details	Bbn	Price	Price	Weight	Pack
mm ²	mm ²	Type code	Order code	1 piece	group	1 piece	unit
				4012233		kg	pc.
				EAN			

Neutral or protective-conductor terminals without insulation holder

1 x 16	6 x to 16	SZ-6/3	GH V036 0876 R0003	50592 5 ①		0.022	10
1 x 16	2 x to 16 6 x to 10	SZ-KLB 8	GJ I232 0131 R0001	59660 7		0.025	30
1 x 16	2 x to 16 10 x to 10	SZ-KLB 12	GJ I232 0071 R0013	59530 3		0.035	30
1 x 35	4 x to 16 12 x to 10	SZ-KLB 16	GJ I232 0072 R0017	59540 2		0.077	30
1 x 35	4 x to 16 20 x to 10	SZ-KLB 24	GJ I232 0073 R0016	59550 1		0.100	30

Holders for SZ-KLB terminals

Screw-fixing
SZ-KLB 8 and 12 each 1 piece required
SZ-KLB 16 and 24 each 2 pieces required

	SZ-Ktr	GJ I202 4027 R0001	59450 4		0.003	100
--	---------------	--------------------	----------------	--	-------	-----

Neutral and protective-conductor terminals with insulation holder for quick fastening onto DIN rails EN 50022

Neutral with blue insulation holder; type C finger safe, conductor opening closed on one side

1 x 16	6 x 16	SZ-N 6/3	GH V036 0876 R0001	55570 3		0.027	20
1 x 16	11 x 16	SZ-N 11/3	GH V036 0876 R0002	55580 2		0.043	20
1 x 16	6 x 16	SZ-N 6/3 C	GH V036 0876 R0011	57095 4 ①		0.028	20
1 x 16	6 x 16	SZ-N 11/3 C	GH V036 0876 R0012	57096 1 ①		0.046	20

Protective conductor with green/yellow insulation holder; type C finger safe, conductor opening closed on one side

1 x 16	6 x 16	SZ-PE 6/3	GH V036 0876 R0004	55600 7		0.027	20
1 x 16	11 x 16	SZ-PE 11/3	GH V036 0876 R0005	55610 6		0.043	20
1 x 16	6 x 16	SZ-PE 6/3 C	GH V036 0876 R0014	57097 8 ①		0.028	20
1 x 16	11 x 16	SZ-PE 11/3 C	GH V036 0876 R0015	57098 5 ①		0.046	20

① bbn-No. 40 16779

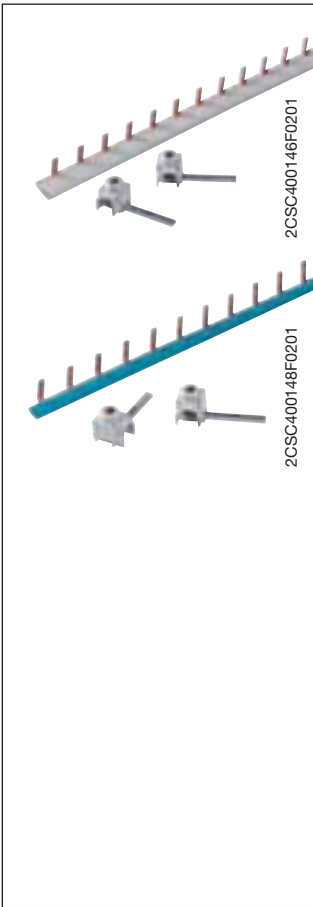

Busbars for SN 201 range

No. pins	Phases	Cross section mm ²	Order details Type code	Order code	Bbn 8012542 EAN	Price 1 piece	Price group	Weight 1 piece kg	Pack unit pc.
12	1	10	BS9 1/12	2CSL910001R1012	047650			0.050	10
12	1	10	BS9 1/12 NA	2CSL910011R1012	047759			0.050	10
56	1	10	BS9 1/56	2CSL910001R1056	047353			0.140	10
56	1	10	BS9 1/56 NA	2CSL910011R1056	047452			0.140	10
12	3	10	BS9 3/12	2CSL930001R1012	047551			0.090	5
57	3	10	BS9 3/57	2CSL930001R1057	047858			0.470	5

Busbars for F200/S200 and SN 201 range

2 + 10 x 1+N	2	10	BF2-S9 UP 1N/12	2CSL920009R1012	046950			0,110	5
4 + 8 x 1+N	4	10	BF2-S9 UP 3N/12	2CSL940009R1012	047056			0,110	5
2 + 10 x 1+N	2	10	BF2-S9 DOWN 1N/12	2CSL920002R1012	047155			0,110	5
4 + 8 x 1+N	4	10	BF2-S9 DOWN 3N/12	2CSL940002R1012	047254			0,110	5

Terminals, insulated

Conn. capacity mm ²	Type of connect.	Terminal lug L mm	Order details Type code	Order code	Bbn 8012542 EAN	Price 1 piece	Price group	Weight 1 piece kg	Pack unit pc.
25	pin	15	FEED-IN 25/15 1P	2CSL980001R2515	047957			0.010	5
25	pin	30	FEED-IN 25/30 3P	2CSL980001R2530	048053			0.010	5

End caps

Order details Type code	Order code	Bbn 8012542 EAN	Price 1 piece	Price group	Weight 1 piece kg	Pack unit pc.
BS9-END 3P ①	2CSL980001R0001	064251			0.001	20

① In combination with BS9 3/57

4

Example of application with SN 201 breakers

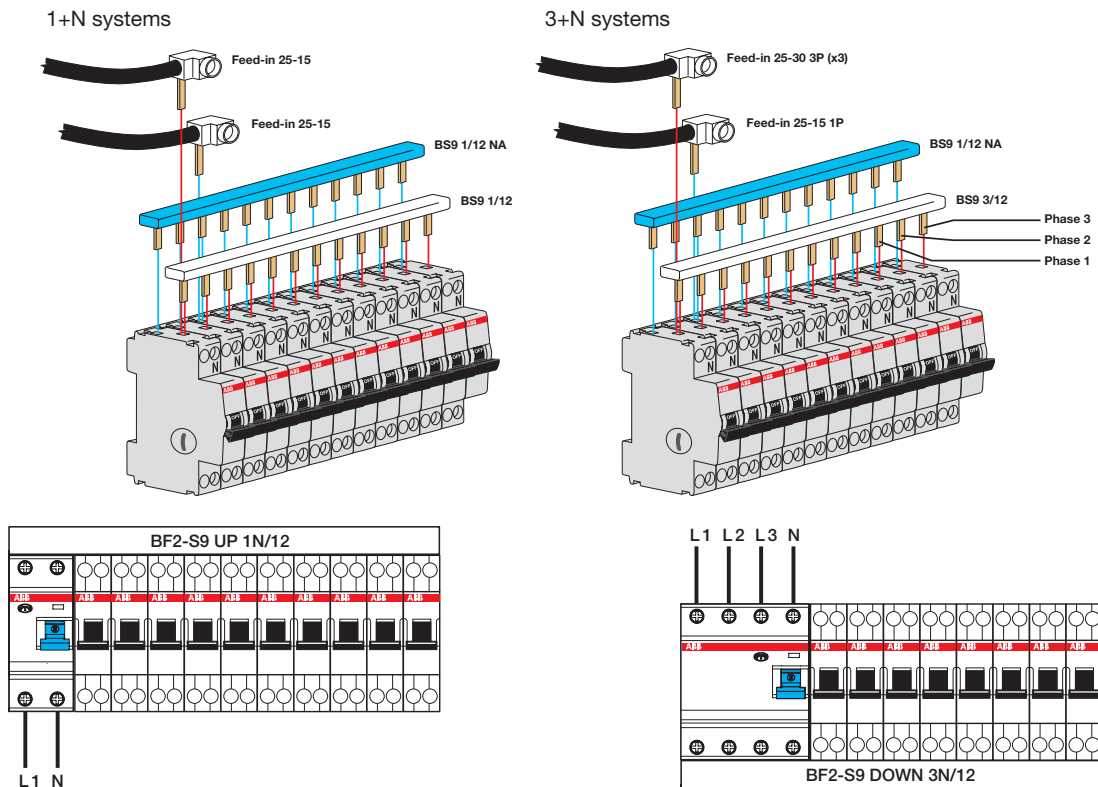

2CSC400020F0202

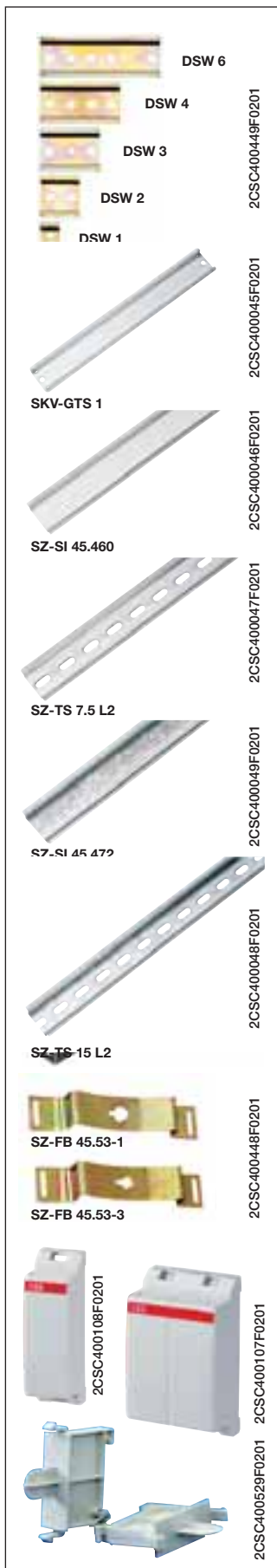

Length mm	Order details Type code	Order code	Bbn 4012233 EAN	Price 1 piece	Price group	Weight 1 piece kg	Pack unit pc.
--------------	-------------------------------	------------	-----------------------	------------------	----------------	-------------------------	---------------------

DIN rails

DIN rails (DIN EN 60 715 – 35 x 7.5) for individual installation with 2 screws on an even surface (1 module = 17.5 mm)

for 1 module	DSW 1	GH S210 1926 R0001	13580 6			0.060	10
for 2 modules	DSW 2	GH S210 1926 R0002	13590 5			0.012	10
for 3 modules	DSW 3	GH S210 1926 R0003	13600 1			0.018	10
for 4 modules	DSW 4	GH S210 1926 R0004	13610 0			0.024	10
for 6 modules	DSW 6	GH S210 1926 R0006	13620 9			0.036	10

DIN rail DIN EN 60 715, 35 x 7.5, material thickness 1 mm, surface protected, galvanised.

241	SKV-GTS 1	GH L110 1915 R0001	04090 2			0.09	40
-----	------------------	--------------------	----------------	--	--	------	----

DIN rails DIN EN 60 715, 35 x 7.5, material thickness 1 mm, surface galvanised.

1000	SZ-SI 45.460	GJ I232 2218 R0001	59730 7			0.35	10
2000	SZ-TS 7.5 L2	GJ I232 2218 R0007	59760 4			0.70	20

DIN rails DIN EN 60 715, 35 x 15, material thickness 1.5 mm, surface galvanised

2000	SZ-SI 45.472	GJ I232 2218 R0010	59780 2			1.30	10
2000	SZ-TS 15 L2	GJ I232 2218 R0009	59770 3			0.78	10

Spring catch for mounting devices onto DIN rails (DIN EN 60 715, 35 x 7.5)

for screw type M4	SZ-FB 45.53-3	GJ I184 2013 P0003	64560 2			0.03	50
for screw type M5	SZ-FB 45.53-1	GJ I184 2013 P0004	64580 0			0.03	50

False poles

Description	Order details Type code	Order code	Bbn 8012542 EAN	Price 1 piece	Price group	Weight 1 piece kg	Pack unit pc.
False pole - 1 module	FP1	16021765	061304			0.01	100
False pole - 2 modules	FP2	16021773	061403			0.014	50
False pole - 4 modules	FP4	16021781	061502			0.022	30
False pole - 6 modules	FP6	16021799	061601			0.031	20
Support for false pole	SFP	16021831	061700			0.012	100



Height of cutout/color	Width	Order details	Bbn	Price	Price	Weight	Pack
mm	mm	Type code	Order code	1 piece	group	1 piece	unit
				EAN		kg	pc.

Blanking plates

For device covers with materials of a thickness of 1 to 3 mm, width: 1 module = 17.5 mm; color: grey RAL 7035, white RAL 9001

46/grey	213	SZ-BP 1	GH L530 1904 R0001	06050 4		0.028	100
46/white	17.5	SZ-BP	GH S270 1913 R0001	12857 4 ①		0.005	
46/grey	17.5	SZ-BP 2	GH S270 1913 R0002	12861 1 ①		0.005	
46/grey	220	SZ-BP 12 G	2CDL 000 001 R1220	65227 8 ①		0.022	50
46/white	220	SZ-BP 12 W	2CDL 000 001 R2220	66355 7 ②		0.020	50

Description	Order details	Bbn	Price	Price	Weight	Pack
	Type code	Order code	1 piece	group	1 piece	unit
			EAN		kg	pc.

Locking devices for SZ-BP 12 G	SZ-BP R	2CDL 000 001 R1001	652285 ①		0.001	30
--------------------------------	----------------	--------------------	-----------------	--	-------	----

Sealing plate

Seal-proof locking of stamped-out device covers. Detachable only from the inside of the device cover. Can be used for device covers with 1.5 to 3 mm material thickness.

Height of cutout/color	Width	Order details	Bbn	Price	Price	Weight	Pack
mm	mm	Type code	Order code	1 piece	group	1 piece	unit
				EAN		kg	pc.

46/grey	1500	SZ-VP 1500	GJ I995 9038 R0001	60290 2		0.366	10
---------	------	-------------------	--------------------	----------------	--	-------	----

Rotary operating mechanism

For the actuation of 2-, 3- or 4pole miniature circuit-breakers in closed distribution boards for drive-axes of 5 or 6 mm² (square)

	S2C-DH	GH S200 1901 R0003	57960 5 ①		0.01	25
--	---------------	--------------------	------------------	--	------	----

End bracket

Prevents lateral shifting of built-in devices mounted on DIN rails according to DIN EN 60 715, 35 x 7.5 mm.

	END	GJ I100 1814 R0001	59090 2		0.02	50
--	------------	--------------------	----------------	--	------	----

Filling piece

e.g. for heat dissipation of closely mounted devices that generate much heat. Width 8.75 mm, as spacer, two different heights, breakable, for DIN rails according to DIN EN 60 715, 35 x 7.5 mm.

8.75	SZ-FST 2	GH L530 1908 R0002	06070 2		0.01	25
------	-----------------	--------------------	----------------	--	------	----

Spring piece

Holder for device covers, various heights available (in connection with FST 2 filling piece)

	SZ-FDT 2	GH L530 1908 R0005	06080 1		0.002	25
--	-----------------	--------------------	----------------	--	-------	----

Filling piece

Two different heights, breakable, for DIN rails according to DIN EN 60 715, 35 x 7.5 mm for MCBs S 220 (3 different heights)

8.75	SZ-FST	GH I148 0003 R0001	59410 8		0.01	25
------	---------------	--------------------	----------------	--	------	----

① bbn-Nr. 4016779



SZ-ES 68/83

2CDC051130F0008



SA 1

2CSC400453F0201



SA 2

2CSC400454F0201

2CSC400053F0201



KA 27 H + KA 27 S



PCD 2 N



PCD 4 N

2CSC400435F0201



PCD 8 N

2CSC400437F0201

Description	Order details	Bbn 4012233	Price 1 piece	Price group	Weight 1 piece	Pack unit
	Type code	Order code	EAN		kg	pc.

Elevation piece

Compensates for different size of built-in devices with a mounting height of 68 mm and power MCBs of series S500 (83 mm)

SZ-ES 68/83	GH V021 1425 R0001	53390 9			0.003	100
-------------	--------------------	---------	--	--	-------	-----

Locking device for MCBs and switches

Prevents unauthorised or dangerous operation of the operating lever. An adaptor makes it possible to block the operating lever whether switched ON or OFF. The lever is blocked with a padlock having a cross bar section of 3 or, as the case may be, 6 mm max. For multipole devices, one lock may be fitted per pole.

The lock adaptor can be used for all MCBs of the S 220, S 280 series as well as for switches E 200. The lock adaptor SA 1/S 290 can be used for all MCBs of the S 290 series.

locking devices for padlock bar	3 mm	SA 1	GJ F110 1903 R0001	58760 5 ②		0.004	10
	6 mm	SA 1E	GJ F110 1903 R0004	58790 2 ②		0.004	10
locking devices for S 290, padlock bar	3 mm	SA 1/S 290	GJ F110 1903 R0007	58261 2 ①		0.004	10
padlock with 2 keys		SA 2	GJ F110 1903 R0002	58770 4 ②		0.02	10
padlock, identical locking with 2 keys		SA 2 i	GJ F110 9999 R0001	96940 1 ②		0.02	10
lock adaptor incl. padlock with 3 keys in transparent box		SA 3	GJ F110 1903 R0003	58780 3 ②		0.05	10

Terminal cover KA 27

Provides overall touch protection of live parts. Suitable for installations acc. to DIN EN 50274 (DIN VDE 0660 Part 514) and BGV A2.

End parts can be snapped onto mounting rails EN 60 715, 35 mm. Covers are 486 mm = 27 modules (18 mm each) long. Knockouts for each half module for individualised use.

cover, 1 piece	KA 27 H	GH S210 1933 R0001	13630 8		0.104	10
end part, 1 piece	KA 27 S	GH S210 1934 R0001	13640 7		0.027	10

Terminal covers with base plate, protection IP 40

Material: high-impact and flame-retardant (UL 94 V-0), color: white (RAL 9001), glow-wire test 960 °C according to IEC 695-2-1

The base plate has an integrated top-hat rail for snap-on fixing of MCBs, RCDs, modular built-in devices, etc.

for 2 modules	PCD 2 N	GH S270 1921 R0002	12402 6 ①		0.09	1
for 4 modules	PCD 4 N	GH S270 1921 R0004	12404 0 ①		0.15	1
for 6 modules	PCD 6 N	GH S270 1921 R0006	12406 4 ①		0.2	1
for 8 modules	PCD 8 N	GH S270 1921 R0008	12408 8 ①		0.7	1

Common terminals for terminal covers PCD

for PCD 4 N and 6 N	KL-PCD 4/6	GH S270 1912 R0004	12502 3 ①		0.017	
for PCD 8 N	KL-PCD 8	GH S270 1912 R0008	12592 7 ①		0.079	

① bbn-No. 80 00126 ② bbn-No. 40 16779

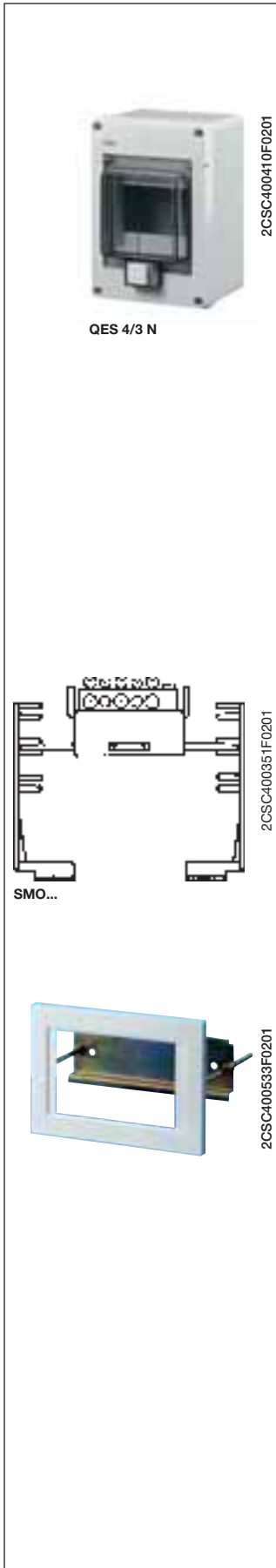

Insulated housings IP 55

come with DIN rail according to DIN EN 60 715 and cable entry grommet without N + PE common terminals (see SMO)

Material: high-impact and flame-retardant (UL 94 V-0), color grey (RAL 7035), glow-wire test 960 °C according to IEC 695-2-1

Type with knock-outs ø in mm	Enclosed cable grommets	Order details Type code	Order code	Bbn 8000126 EAN	Price 1 piece	Price group	Weight 1 piece kg	Pack unit pc.
---------------------------------	-------------------------	----------------------------	------------	-----------------------	------------------	-------------	-------------------------	------------------

housings for 4 modules

2 x Ø 27	2	QES 4/3 N	GH L111 2304 R0013	12644 0			0.370	18
----------	---	------------------	--------------------	----------------	--	--	-------	----

housings for 6 modules

2 x Ø 27	2	QES 6/3 N	GH L111 2306 R0013	12646 4			0.440	12
----------	---	------------------	--------------------	----------------	--	--	-------	----

housings for 10 modules

6 x Ø 32	3	QES 10/3 N	GH L111 2310 R0013	12650 1			0.690	10
----------	---	-------------------	--------------------	----------------	--	--	-------	----

N + PE common terminals for QES (IP 55)

Neutral and protective-conductor terminals with insulation holder for screw-fixing

Description	Order details Type code	Order code	Bbn 4012233 EAN	Price 1 piece	Price group	Weight 1 piece kg	Pack unit pc.
for QES 4/3 N	SMO 4	GH L430 1910 R0004	12880 2			0.093	10
for QES 6/3 N	SMO 6	GH L430 1910 R0006	12882 6			0.125	10
for QES 10/3 N	SMO 10	GH L430 1910 R0010	12884 0			0.105	10

Flanges

Description	Order details Type code	Order code	Bbn 8012542 EAN	Price 1 piece	Price group	Weight 1 piece kg	Pack unit pc.
Flange for rear board fixing 1 module - IP40	ME 1	16219300	304401			0.040	1
Flange for rear board fixing 2 modules - IP40	ME 2	16219318	304500			0.045	1
Flange for rear board fixing 3 modules - IP40	ME 3	16219326	304609			0.055	1
Flange for rear board fixing 4 modules - IP40	ME 4	16219334	304708			0.060	1
Flange for rear board fixing 6 modules - IP40	ME 6	16219342	304807			0.070	1
Flange for rear board fixing 8 modules - IP40	ME 8	16219359	304906			0.080	1

The S 280 and S 280 UC series of MCBs are supported by a whole group of auxiliary elements with many functions and configurations. Undervoltage releases, shunt trips, auxiliary contacts, signal contacts, mechanical interlocks are available. A wide range of auxiliary elements considerably improves the performance of the MCBs and enables innovative and integrated solutions to be used in every installation.

The S 290 circuit-breakers are supplied with special shunt trips, undervoltage releases and contacts (auxiliary and signal). All the accessories are installed to the right of the circuit-breaker. The left part is used for installing RCD blocks.

Also S800 MCBs series is completed with a wide range of accessories which includes auxiliary and signal contacts, separating neutral, rotary handles and interchangeable adapter kits.

All the auxiliary elements are installed to the left side of the circuit breakers.

The right part is used for installing DDA 800 RCD blocks.



ABB Auxiliary elements and accessories for MCBs S 280, S 290 and S800 series and for RCD-blocks DDA 800

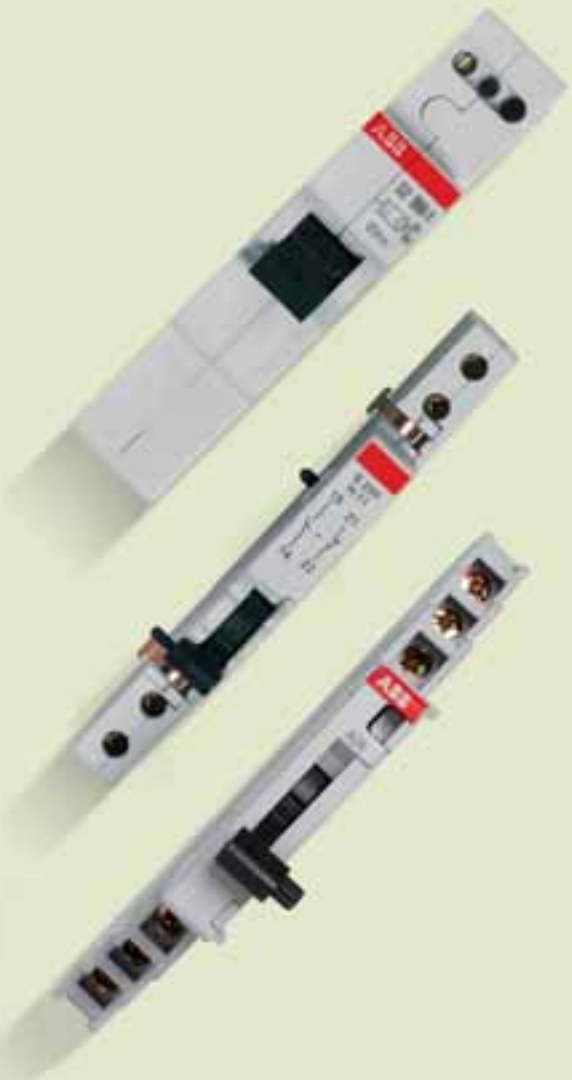

Index

Schemes for combination of auxiliary elements and MCBs S 280 series	4/46
Technical features of auxiliary elements for MCBs S 280 series	4/46
Selection tables of auxiliary elements for MCBs S 280 series	
Shunt trips.....	4/48
Auxiliary contacts	4/48
Signal/auxiliary contacts	4/48
Undervoltage releases.....	4/49
Hand operated neutral	4/49
Schemes for combination of auxiliary elements and accessories for MCBs S 290 series	4/50
Technical features of auxiliary elements and accessories for MCBs S 290 series ...	4/51
Selection tables of auxiliary elements for MCBs S 290 series	
Shunt trips.....	4/52
Signal/auxiliary contact	4/52
Undervoltage releases.....	4/52
Technical features S700 series	4/53
Selection tables of accessories for S700	4/54
Schemes for combination of auxiliary elements and accessories for MCBs S800 series	4/55
Technical features of auxiliary elements for MCBs S800 series	4/56
Selection tables of auxiliary elements and accessories for MCBs S800 series	
Short-circuit current limiters with cage terminal	4/58
Short-circuit current limiters with ring terminal cable connection.....	4/58
Auxiliary contact.....	4/58
Signal/auxiliary contact	4/58
Separating neutral	4/58
Remote switching.....	4/58
Shunt operation releases	4/59
Under voltage releases.....	4/59
Accessories	4/53
Auxiliary elements and accessories for MCBs S500 series	4/61
Auxiliary elements and accessories for DDA800 RCD-blocks	4/61

Combination between auxiliary elements and S 280

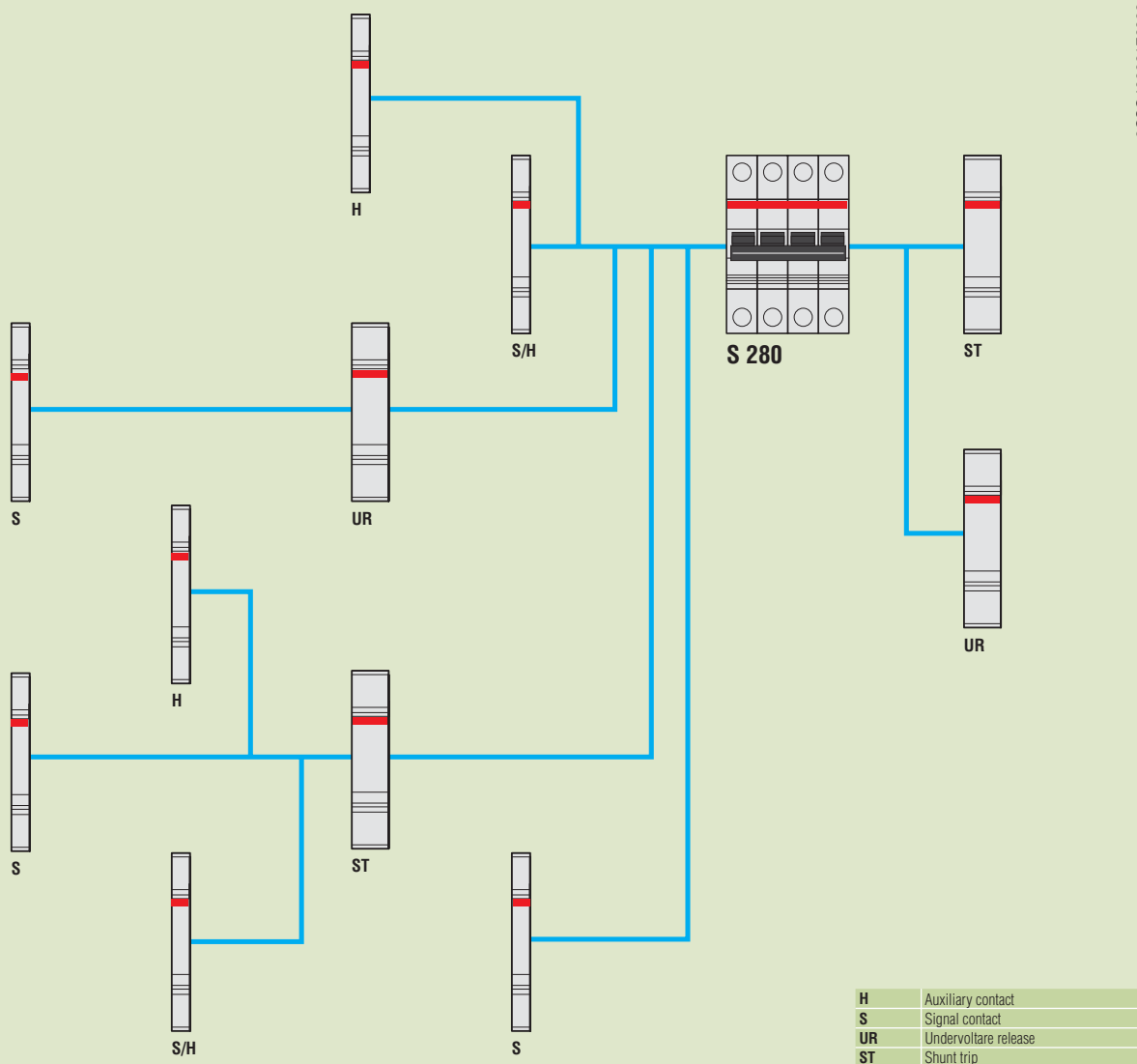

Technical characteristics of auxiliary and signal contacts

Type	S2-H11 I S2-H11 X	S2-H20 I S2-H20 X	S2-H02 I S2-H02 X	S2-H21	S2-H12	S2-H30	S2-H03
Description	1NO+1NC	2NO	2NC	2NO+1NC	1NO+2NC	3NO	3NC
Alternating current	Ue [V]			240 415			
	Ie [A]			6 2			
Direct current	Ue [V]		24	60 110 250			
	Ie [A]		4	2 1.5 1			
Min. operating voltage	[V]			12 a.c.-12 d.c.			
Min. operating current	[mA]			12			
Terminals	[mm ²]			up to 2x1.5			
Dielectric strength	[kV]			3			
Resistance to short-circuit at 240 V a.c.	[A]		1000 (protected with S 2 breaker characteristic K - 6 A)				
Impulse voltage withstand capacity	[kV]			4			
Tightening torque	[Nm]			0.7			
Dimensions (WxDxH)	[mm]			8.75x68x90			

NB: the auxiliary contacts S2-H11 X, S2-H20 X, S2-H02 X differ from the contacts S2-H11, S2-H20, S2-H02 in that they do not have a terminal to tighten the cable which is replaced by a bayonet for the Faston connection.

Technical characteristics of shunt trips

Type		S2-A1	S2-A2
Rated voltage	[V]		
	a.c.	12 - 60	110 - 415
	d.c.	12 - 60	110 - 250
Max. release duration	[ms]	<10	<10
Min. release voltage	[V]		
	a.c.	7	55
	d.c.	10	80
Consumption on release	[VA]		
	12 V a.c.	35	
	12 V d.c.	30	
	24 V a.c.	140	
	24 V d.c.	100	
	48 V a.c.	600	
	48 V d.c.	330	
	110 V a.c.		40
	110 V d.c.		40
	220 V a.c.		180
220 V d.c.		170	
Coil resistance	[Ω]	3.7	225
Terminals	[mm ²]	25	25
Tightening torque	[Nm]	2	2
Dimens.(WxDxH)	[mm]	17.5x68x90	17.5x68x90

Technical characteristics of undervoltage releases

Type		S2-UA 12	S2-UA 24	S2-UA 48	S2-UA 110	S2-UA 220	S2-UA 380
Standards		VDE0660 part I - IEC EN 60947.1					
Rated voltage	[V] a.c.	-	24	48	110	220-240	380
	[V] d.c.	12	24	-	110	220-240	380
Frequency	[Hz]	50...60					
Release trip	[V]	0.35 Un ≤ V ≤ 0.7 Un					
Terminals	[mm ²]	2 x 1.5					
Consumption	[mA]	10					
Resistance to corrosion	[°C/RH]	const. climatic cond.: 23/83-40/93-55/20; var. climatic cond.: 25/95-40/93					
Protection degree		IP20					
Tightening torque	[Nm]	0.4					
Dimensions (WxDxH)	[mm]	17.5x68x90					

	S2-S	S2-SH
	1 change over	2 change over
		240 415
		6 2
	250	110 60 24
	0.5	1 1 4
	12 a.c.-12 d.c.	
	12	
	up to 2x1.5	
	3	
	1000 (protected with S 2 breaker characteristic K - 6 A)	
	4	
	0.7	
	8.75x68x90	



2CSC400495F0201

S2-A1 I,
S2-A2 I

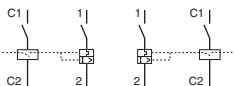

Description	Order details		Bbn 4012233 EAN	Price 1 piece	Price group	Weight 1 piece kg	Pack unit pc.
	Type code	Order code					

Shunt trips

Function: remote opening of the device when a voltage is applied
Suitable for MCBs S 280 and S 280 UC series

12-60 VAC/VDC shunt trip	S2-A1	GH S280 1909 R0001	42930 1			0.145	1
110-415 VAC and 110-250 VDC shunt trip	S2-A2	GH S280 1909 R0002	42940 0			0.145	1

Auxiliary contacts

Function: indication of the position of the device's contacts
Suitable for MCBs S 280 and S 280 UC series

Signal contacts

Function: indication of the position of the device's contacts only after the automatic release of the MCBs and RCBOs due to an overload or a short-circuit
Suitable for MCBs S 280 and S 280 UC series

Auxiliary contact 1 NO + 1 NC (1/2 module)	S2-H11	GH S270 1916 R0001	61500 1			0.04	1
Auxiliary contact 2 NO (1/2 module)	S2-H20	GH S270 1916 R0002	61510 0			0.04	1
Auxiliary contact 2 NC (1/2 module)	S2-H02	GH S270 1916 R0003	61520 9			0.04	1
Auxiliary contact 1 NO + 1 NC (1/2 module) with Faston connections	S2-H11X	GH S270 1917 R0001	61530 8			0.04	1
Auxiliary contact 2 NO (1/2 module) with Faston connections	S2-H20X	GH S270 1917 R0002	61540 7			0.04	1
Auxiliary contact 2 NC (1/2 module) with Faston connections	S2-H02X	GH S270 1917 R0003	61550 6			0.04	1
Auxiliary contact 2 NO + 1 NC (1/2 module)	S2-H21	GH S270 1936 R0001	01370 3*			0.05	1
Auxiliary contact 1 NO + 2 NC (1/2 module)	S2-H12	GH S270 1936 R0002	01380 2 *			0.05	1
Auxiliary contact 3 NO (1/2 module)	S2-H30	GH S270 1936 R0003	01390 1*			0.05	1
Auxiliary contact 3 NC (1/2 module)	S2-H03	GH S270 1936 R0004	01400 7*			0.05	1
Signal contact (1/2 module)	S2-S	GH S280 1902 R0008	12770 7*			0.07	1
Signal contact + Auxiliary contact (1/2 module)	S2-S/H	GH S280 1901 R0008	42900 4			0.05	1

* Bbn 4016779

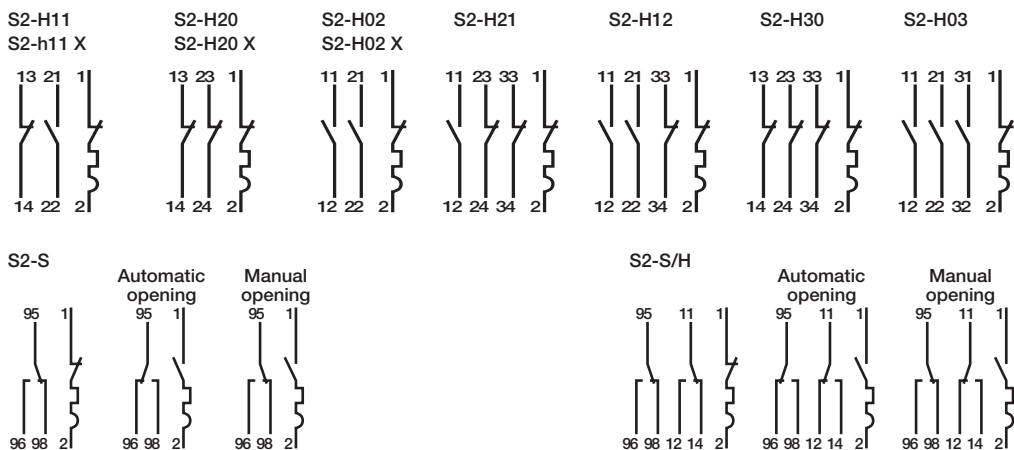

2CSC400497F0201



2CSC400498F0201



2CSC400499F0201

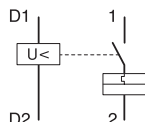

Undervoltage releases

Function: protection of the load in the event of a voltage drop (between 70% and 35% of its rated value); positive safety (device's tripping when the voltage is disconnected) emergency stop by means of a button.

Suitable for MCBs S 280 and S 280 UC series

Description	Order details	Bbn	Price 4012233	Price 1 piece	Weight group	Pack 1 piece	unit
Undervoltage release 12V DC (1 module)	S2-UA 12	GH S280 1911 R0001	42970 7			0.09	1
Undervoltage release 24V AC/DC (1 module)	S2-UA 24	GH S280 1911 R0002	42980 6			0.09	1
Undervoltage release 48V AC/DC (1 module)	S2-UA 48	GH S280 1911 R0003	79360 0			0.09	1
Undervoltage release 110V AC/DC (1 module)	S2-UA 110	GH S280 1911 R0004	43000 0			0.09	1
Undervoltage release 220V AC/DC (1 module)	S2-UA 220	GH S280 1911 R0005	43010 9			0.09	1
Undervoltage release 380V AC (1 module)	S2-UA 380	GH S280 1911 R0006	79370 9			0.09	1

Hand operated neutral

The hand operated neutral has to be mounted to the left side of the MCB and be snapped on the DIN rail. It is used for measuring duties where the neutral conductor must be in the open position. Due to the special design of the handle - when switching ON the MCB – the neutral will make before the MCB is closed.

The S2C - Nt is not to switch with a tool (screw driver).

Hand operated neutral	S2-NT	GH S270 1908 R0001	36610 1			0.06	1
-----------------------	--------------	--------------------	----------------	--	--	------	---

Combination between auxiliary elements and S 290

4

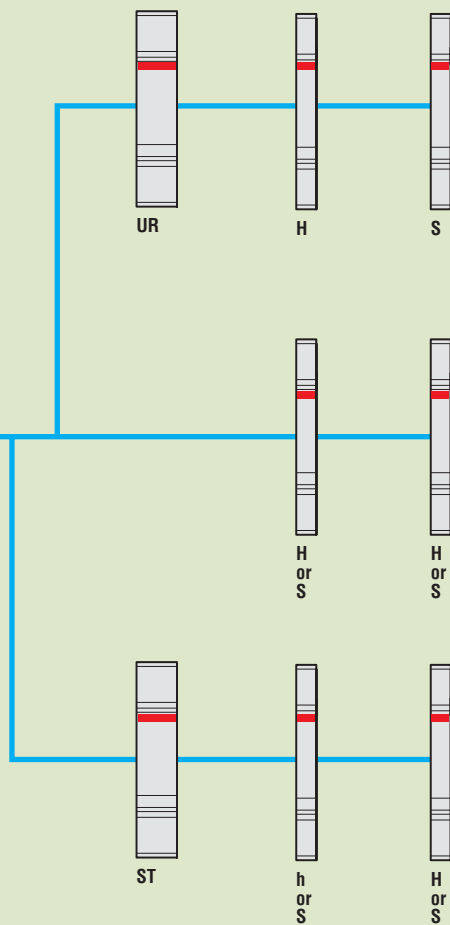
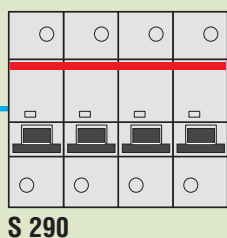
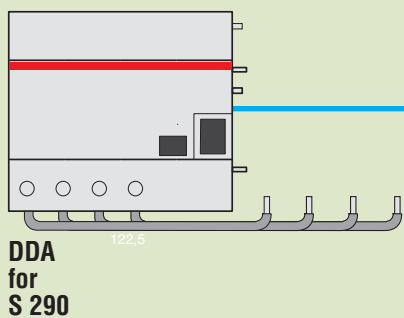

H	Auxiliary contact
S	Signal contact
ST	Shunt trip
UR	Undervoltare release

2CSC400022F0202

Technical characteristics of shunt trips

Type		S 290 A1	S 290 A2
Rated voltage	[V] a.c.	110...415	24...48
	d.c.	110	24...48
Max. release duration	[ms]	<10	<10
Peak-up power	[W]	110 V AC/ DC: 8 415 V AC: 153	24 V AC/ DC: 23 48 V AC/ DC: 108
	Terminals		
	solid conductor [mm ²]		2 x 1.5 max
	strandet conductor		2 x 1 max
	flexible conductor		2 x 1 max
Tightening torque	[Nm]	2	2
Dimensions (WxDxH)	[mm]	17.5x68x90	17.5x68x90

Technical characteristics of auxiliary and signal contacts

Type		S 290 H11 S 290 S
Description		1NO+1NC
Alternating current (AC 13)	Ue [V]	230/400
	Ie [A]	6/2
Direct current (DC 13)	Ue [V]	24/60/110/220
	Ie [A]	6/3/1/1
Min. operating voltage	[V]	12 a.c.-12 d.c.
Min. operating current	[mA]	5
Terminals	solid conductor [mm ²]	1 x 0.5 ... 1 x 4
	strandet conductor	1 x 1.5 ... 1 x 2.5
	flexible conductor	1 x 0.5 ... 1 x 2.5
Dielectric strength	[kV]	3
Resistance to short-circuit at 240 V a.c.	[A]	1000 (protected with breaker char. K 6 A)
Impulse voltage withstand capacity	[kV]	4
Tightening torque	[Nm]	0.5
Dimensions (WxDxH)	[mm]	8.75x68x90

Technical characteristics of undervoltage releases

Type		S290-UA 24	S290-UA 110	S 290-UA 230
Standards		VDE0660 part I - IEC EN 60947.1		
Rated voltage	[V] a.c.	230		
	[V] d.c.	-		
Frequency	[Hz]	50...60		
Release trip threshold	[V]	0.35 Un ≤ V ≤ 0.7 Un		
Terminals	[mm ²]	2x1.5		
Consumption [W]		2,3	1,74	1,44
Resistance to corrosion	[°C/RH]	constant atmosphere: 23/83-40/93-55/20; variable atmosphere: 25/95-40/93		
Protection degree		IPXXB/IP2X		
Tightening torque	[Nm]	0.4		
Dimensions (WxDxH)	[mm]	17.5x68x90		



2CSC400496F0201

S 290 A1
S 290 A2

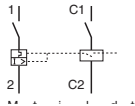

2CSC400500F0201

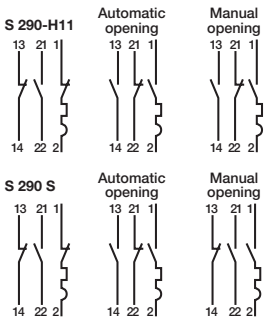

2CSC400397F0201

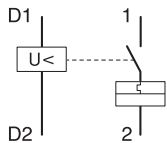

Description	Order details	Bbn	Price	Price	Weight	Pack
	Type code	Order code	1 piece	group	1 piece	unit
		EAN			kg	pc.

Shunt trips

Function: remote opening of the device when a voltage is applied
Suitable for MCBs S 290 series

110-415V AC/110 DC shunt trip	S 290 A1	GH S290 1909 R0011	57033 6	0,09	1
24-48V AC/DC	S 290 A2	GH S290 1909 R0012	57034 3	0,09	1

Auxiliary contact

Function: indication of the position of the device's contacts
Suitable for MCBs S 290 series

Signal contact

Function: indication of the position of the device's contacts only after the automatic release of the MCBs and RCBOs due to an overload or a short-circuit
Suitable for MCBs S 290 series

Auxiliary contact 1 NO + 1 NC (1/2 module)	S 290 H11	GH S290 1916 R0011	57031 2	0,05	1
Signal contact (1/2 module)	S 290-S11	GH S290 1902 R0018	57032 9	0,05	1

Undervoltage releases

Function: protection of the load in the event of a voltage drop (between 70% and 35% of its rated value); positive safety (device's tripping when the voltage is disconnected) emergency stop by means of a button.

Suitable for MCBs S 290 series

Undervoltage release DC 24 V	S 290-UA 24	GH S290 1911 R0012	57035 0	0,09	1
Undervoltage release DC 110 V	S 290-UA 110	GH S290 1911 R0014	57036 7	0,09	1
Undervoltage release AC 230 V	S 290-UA 230	GH S290 1911 R0015	57037 4	0,09	1

Auxiliary switch S700 + H2WR

2 Switch-over contacts

Conv. thermal current I_{th}	10 A
Min. operating voltage	24 V AC/DC
Min. switching power	5 VA ①
Short-circuit withstand capability	1000 A @ 230 V AC with S 200 K6 back-up
Isolation coordination	
– overvoltage category	III
– pollution degree	2
– surge withstand capability	4 kV (1.2/50 μ s)
Wiring	up to 2 x 1.5 mm ²
Contact reliability under	5 g, 20 cycles 5...150...5 Hz @ 24 V AC/DC, 5 mA –> contact

① the min. operating current under operating conditions acc. to EN 60204-1 and EN 60439-1
(indoor installation): 24 V AC/DC, 5 mA (AC 12, DC 12)

AC 14	Ue	400 V	230 V
	Ie	2 A	6 A
DC 12	Ue	220 V	110 V
	Ie	1 A	1.5 A
DC 13	Ue	60 V	24 V
	Ie	2 A	4 A

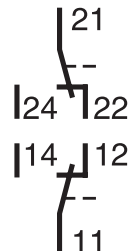



Mounting adapters

Application	Order details	Bbn	Price	Price group	Weight	Pack unit
	Type code	Order code	1 piece		1 piece	pc.
		EAN			kg	

DIN rail adapter

for mounting S 700 onto 1 or 2 DIN rails 35 mm acc. to EN 50022 (distance of DIN rails 125 mm when using 2 DIN rails)

no. to be used:

S701: 1 pc.	S 700 BT 3	GHS7 001 902 R0003	28440 0 ①			10
S 702, S703, S704: 2 pc						

Busbar adapter

for mounting onto 40 mm busbar systems, 4 or 5 pole, with busbars 5 x 12 mm or 10 x 12 mm

single phase:

L1 or L2 or L3 (adjustable)	S 700 SA 1	GHS7 001 917 R0001	25430 4 ①		0.105	1
3-phase	S 700 QA	GHS7 001 106 R0001	52793 4 ①		0.35	1

Terminal covers, 2 per pole

within the shape of S 700	S 700 KA 1	GHS7 001 903 R0001	52050 3		0.001	6
for cutouts of 160 mm	S 700 KA 2	GHS7 001 907 R0001	52090 9		0.01	6
for cutouts of 175 mm	S 700 KA 3	GHS7 001 908 R0001	52100 5		0.01	6
with cable entry	S 700 KA 4	GHS7 001 913 R0001	52140 1		0.015	6
for IP20 protection (front)	S 700 KA 5	GHS7 001 903 R0005	24300 1 ①		0.003	6

Handle covers, 1 per pole

to prevent manual switch-off	S 700 SPA	GHS7 001 905 R0001	52060 2		0.001	10
to prevent manual switch-off/-on transparent	S 700 SPB 1	GHS7 001 906 R0001	52070 1		0.002	10
grey	S 700 SPB 2	GHS7 001 906 R0002	52080 0		0.002	10

Locking for 3 mm padlock

locking plate 3 pole	S 700 SPE	GHS7 001 909 R0001	52110 4		0.002	10
----------------------	------------------	--------------------	----------------	--	-------	----

① bbn-No. 4016779

System pro M compact® Schemes for combination Auxiliary elements and accessories for MCBs S800 series

Combination between auxiliary elements and S800

2CSC400023F0202

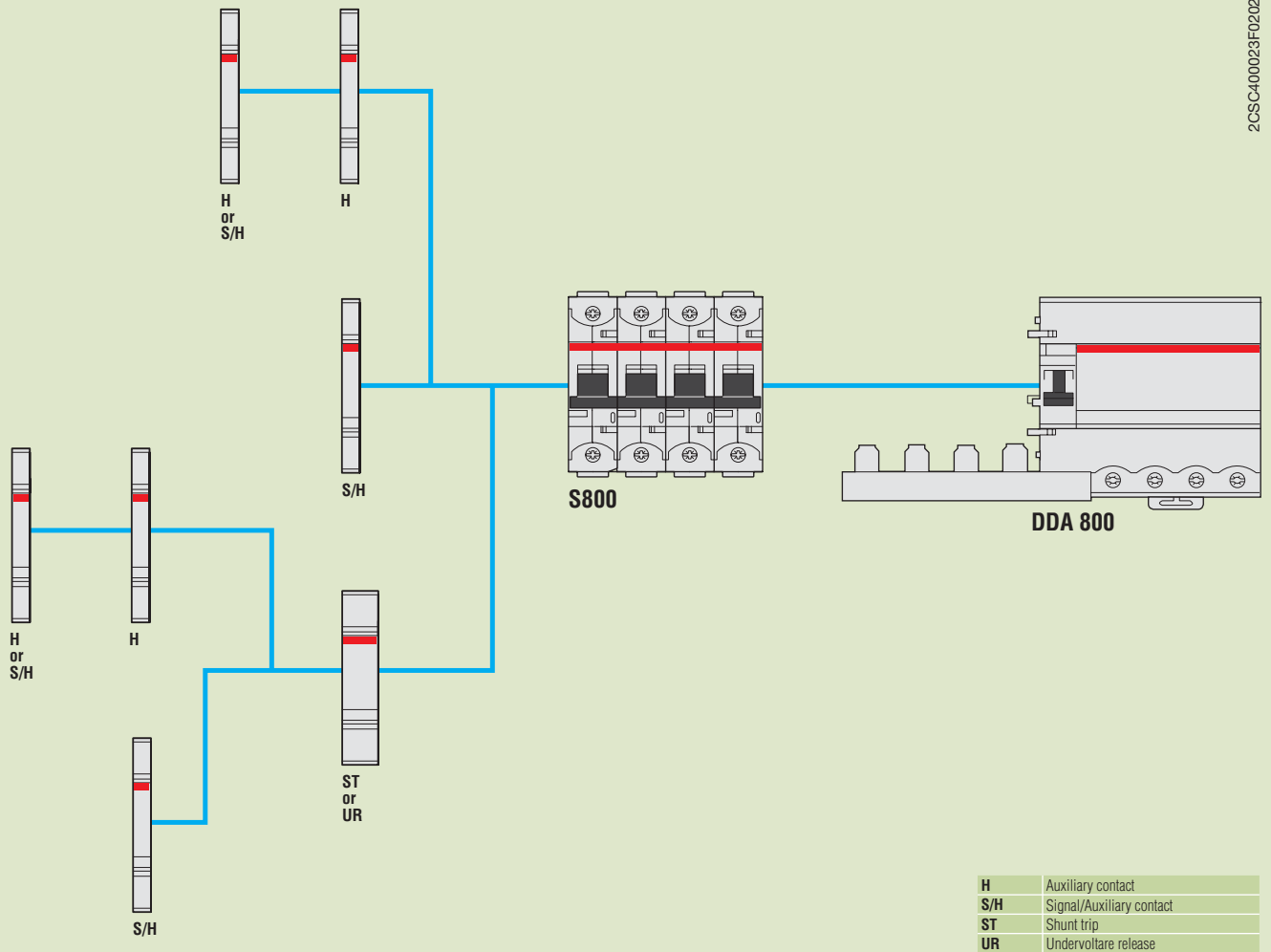

4

Remote switch unit S800-RSU-H

Operating voltage	[V]	24 DC
Current consumption I _{rms}	[A]	2.5
Stand-by current	[mA]	< 50
Switching time OFF-ON	[ms]	< 500
Switching time ON-OFF	[ms]	< 250
Ambient operation temperature	[°C]	-25...+70
Switching cycles over lifetime		10000
Standard		IEC 60947-2 Annex N
Protection		IP20
Weight	[g]	300
Connection		10 pole Micro Fit 3.0

4 Short circuit limiter S803S-SCL

Max. rated continuous current I _n	[A]	32, 63, 125
Poles		3
Rated operating voltage U _e (AC) 50/60Hz	[V]	400/690
Rated insulation voltage U _i	[V]	690
Rated impulse withstand voltage U _{imp}	[kV]	8
Ultimate short-circuit breaking capacity I _{cu} in accordance with IEC 60947-2		
400VAC	[kA]	100
440VAC	[kA]	100
690VAC	[kA]	50

Valid combination see: <http://www.abb.com/product>
Low Voltage Products and Systems/Modular DIN Rail Products/High
Performance Circuit Breakers HPCBs/Software

Service short-circuit breaking capacity I _{cs} in accordance with IEC 60947-2		100% I _{cu}
Rated frequency	[Hz]	50/60
Mounting position		any
Disconnecter properties according to IEC 60947-2		yes
Standard		IEC 60947-2
Connection Cu	[mm ²]	1...25 strand 1...35 cable
Connection Cu > 32 A	[mm ²]	6...50 strand 6...70 cable
Tightening torque	[Nm]	min. 3/max. 4
Supply		any
Mounting on DIN top hat rail		EN 60715
Permissible ambient temperature for operations	[°C]	-25...+60
Storage temperature	[°C]	-40...+70
Type of protection		IP20 IP40 (only actuation side)
Classification in accordance with NF-16-101, NF16-102		I3F2
Resistance to vibration		IEC 60068-2-27; IEC 60068-2; EN 61373 Cat.1/ class B

Rated current I _n	Internal resistance R _i	Power loss P _v
[A]	[m Ω]	[W]
32	1.7	1.7
63	1.0	4.0
125	0.6	9.4

Auxiliary contact S800-AUX

Utilisation category		AC15 400/2A AC15 240/6A DC13 250/0.55A DC13 125V/1.1A DC13 60V/2A DC13 24V/4A
Continuous thermal current I _n	[A]	6
Rated insulation voltage U _i	[V]	690
Number of contacts		2
Rated impulse withstand voltage U _{imp}	[kV]	6
Pollution degree		3
Function of contact		Changeover contacts
Connection Cu	[mm ²]	1 x 2.5 2 x 1.5
Tightening torque	[Nm]	1
AC/DC supply		any
Mounting on DIN top hat rail		EN 60715
Type of protection		IP20
Permissible ambient temperature for operations	[°C]	-25...+60
Storage temperature	[°C]	-40...+70
Mech. device service life		6000 switching cycles
I _{cu} with S450E	[A]	1000
Resistance to vibration		IEC 60068-2-6; EN 61373 Cat.1/class B 5g, 20 frequency cycle 5...150...5Hz at 24V AC/DC, 5mA brief interrupt <10ms

Combined auxiliary and signal contact S800 AUX/ALT

Utilisation category		AC15 400/2A AC15 240/6A DC13 250/0.55A DC13 125V/1.1A DC13 60V/2A DC13 24V/4A
Continuous thermal current I _n	[A]	6
Rated insulation voltage U _i	[V]	690
Number of contacts		2 (1x AUX, 1 x AUX/ALT)
Rated impulse withstand voltage U _{imp}	[kV]	6
Pollution degree		3
Function of contact		Changeover contacts
Connection Cu	[mm ²]	1 x 2.5 2 x 1.5
Tightening torque	[Nm]	1
AC/DC supply		any
Mounting on DIN top hat rail		EN 60715
Type of protection		IP20
Permissible ambient temperature for operations	[°C]	-25...+60
Storage temperature	[°C]	-40...+70
Mech. device service life		6000 switching cycles
I _{cu} with S450E	[A]	1000
Resistance to vibration		IEC 60068-2-6; EN 61373 Cat.1/class B 5g, 20 frequency cycle 5...150...5Hz at 24V AC/DC, 5mA brief interrupt <10ms

System pro M compact®

Technical features

Auxiliary elements for MCBs S800 series

Auxiliary elements for S800 series

Shunt Operation Release S800-SOR

		S800-SOR24	S800-SOR130	S800-SOR250	S800-SOR400
Rated voltage Ue	[V AC/DC]	24	48...130	110...250	220...400/250 ①
Operating range	[%] Ue			70...110	
Rated insulation voltage Ui	[V]			690	
Coil pull in consumption	[W/VA]	16.6/17 ①	41.9...307.3 42...310 ①	23...119 20...105 ①	45...148.1
Rated frequency	[Hz]			DC; 50/60	
Pollution degree				3	
Connection Cu	[mm²]			1...25 strand 1...35 cable	
Tightening torque	[Nm]			min.3/ max.4	
AC/DC supply				any	
DIN top hat rail				EN 60715	
Type of protection				IP20 IP40 (only actuation side)	
Permissible ambient temperature of operations	[°C]			-25...+60	
Storage temperature	[°C]			-40...+70	
Resistance to vibration				IEC 60068-2-6; EN61373 Cat.1/class B	

Undervoltage Release S800-UVR

		S800-UVR36	S800-UVR60	S800-UVR130	S800-UVR250
Rated voltage Ue	[V AC/DC]	24...36	48...60	110...130	220...250
Operating range					
Operating opening	[%] Ue			35...70	
Operating closing	[%] Ue			85	
Rated insulation voltage Ui	[V]			690	
Coil pull in consumption	[W/VA]	1.11...1.14/1.2	1.14...1.25/1.3 ①	1.3...1.41/1.4 ①	1.71...1.91/1.9 ①
Rated frequency	[Hz]			DC; 50/60	
Pollution degree				3	
Standard				IEC 60947-5-1, UL 489	
Connection Cu	[mm²]			1...25 strand 1...35 cable	
Tightening torque	[Nm]			min.3/ max.4	
AC/DC supply				any	
DIN top hat rail				EN 60715	
Type of protection				IP20 IP40 (only actuation side)	
Permissible ambient temperature of operations	[°C]			-25...+60	
Storage temperature	[°C]			-40...+70	
Resistance to vibration				IEC 60068-2-6; EN61373 Cat.1/class B	

① according to UL 489

Busbar S803-BB250

Max. rated continuous current In		
Side supply	[A]	125
Central supply	[A]	250
Conditional short circuit current I_p [kA eff] 100 protected by Tmax		
Poles		3
Rated operating voltage Ue		
(AC) 50/60Hz	[V]	400/690
Rated insulation voltage Ui	[V]	690
Rated impulse withstand voltage U _{imp}	[kV]	8
Rated frequency	[Hz]	50
Standards		EN 60439-2:2000
Material of the bars		E-Cu 58 half-hard rolled F25
Material of the insulation profile		Cyclopol C 3600; UL94 V-0 at 1.5mm
Material of the end caps		Polyamide PA66+PA6; UL94 V-0 at 0.4mm Free of halogen and phosphorus
Busbar cross-sections	[mm²]	60
Overvoltage category		III
Pollution degree		2

Busbar Power Connector S803-BBPC120

Max. rated continuous current In	[A]	250
Poles		3
Rated operating voltage Ue	[V]	400/690
Rated frequency	[Hz]	50
Standards		EN 60439-2:2000
Material of the terminals		CuZn39Pb2; material no.:2.0380
Casing material		Polyamide PA66+PA6; UL94 V-0 at 0.4mm Free of halogen and phosphorus
Tightening torque		
At supply end	[Nm]	19
At busbar end	[Nm]	3
Connection cross-section	[mm²]	1.6...120
Pollution degree		2



Description	Order details	Bbn	Price	Price group	Weight	Pack
Type code	Order code	7612271	1 piece		1 piece	unit
		EAN			kg	pc.

Remote switching unit

Remote switching unit	S800-RSU-H	2CCS800900R0501	411244		0.300	1
-----------------------	-------------------	-----------------	---------------	--	-------	---

Description	Order details	Bbn	Price	Price group	Weight	Pack
[A]	Type code	Order code	7612271	1 piece	1 piece	unit
			EAN		kg	pc.

Short-circuit current limiters with cage terminal

32	S803S-SCL32	2CCS800900R0291	208912		0.735	1
63	S803S-SCL63	2CCS800900R0301	208929		0.735	1
125	S803S-SCL125	2CCS800900R0281	208905		0.735	1

Short-circuit current limiters with ring terminal cable connection

32	S803S-SCL32-R	2CCS800900R0332	408916		0.735	1
63	S803S-SCL63-R	2CCS800900R0331	208950		0.735	1
125	S803S-SCL125-R	2CCS800900R0311	208936		0.735	1

Description	Order details	Bbn	Price	Price group	Weight	Pack
Type code	Order code	7612271	1 piece		1 piece	unit
		EAN			kg	pc.

Auxiliary contact

Auxiliary contact	S800-AUX	2CCS800900R0011	206802		0.049	1
-------------------	-----------------	-----------------	---------------	--	-------	---

Combined auxiliary and signal contact

Auxiliary/signal contact	S800-AUX/ALT	2CCS800900R0021	206819		0.050	1
--------------------------	---------------------	-----------------	---------------	--	-------	---

Separating neutral

Separating neutral 63A	S800-NT	2CCS800900R0061	208196		0.115	1
------------------------	----------------	-----------------	---------------	--	-------	---



Description	Order details	Bbn	Price	Price	Weight	Pack
	Type code	7612271	1 piece	group	1 piece	unit
		EAN			kg	pc.

Shunt operation releases

12VAC/DC	S800-SOR12	2CCS800900R0191	212070		0.15	1
24VAC/DC	S800-SOR24	2CCS800900R0191	208318		0.15	1
48...130VAC/DC	S800-SOR130	2CCS800900R0221	208349		0.15	1
110...250VAC/DC	S800-SOR250	2CCS800900R0211	208332		0.15	1
220...400VAC/DC	S800-SOR400	2CCS800900R0231	208356		0.15	1

Under voltage releases

24...36VAC/DC	S800-UVR36	2CCS800900R0241	208363		0.15	1
48...60VAC/DC	S800-UVR60	2CCS800900R0251	208370		0.15	1
110...130VAC/DC	S800-UVR130	2CCS800900R0261	208387		0.15	1
220...250VAC/DC	S800-UVR250	2CCS800900R0271	208394		0.15	1

Rotary drive adapter for 3-4-pole High Performance MCB

Rotary Drive	S800-RD	2CCS800900R0041	208172		0.080	1
--------------	----------------	-----------------	---------------	--	-------	---

Order details	Bbn	Price	Price	Weight	Pack
Type code	8015644	1 piece	group	1 piece	unit
	EAN			kg	pc.

Anthracite/Standard rotary handle for door assembly

Anthracite rotary handle	S800-RHE-H	1SDA060150R1	625771		0.21	1
--------------------------	-------------------	--------------	---------------	--	------	---

Red/Emergency rotary handle for door assembly

Red rotary handle	S800-RHE-EM	1SDA060151R1	625764		0.21	1
-------------------	--------------------	--------------	---------------	--	------	---

Axial extension of rotary drive – rotary handle 500mm

Axial extension 500mm for RHE	S800-RHE-S	1SDA060179R1	626242		0.19	1
----------------------------------	-------------------	--------------	---------------	--	------	---



IP54 protection for rotary handle

IP54 kit	S800-RHE-IP54	1SDA060180R1	626259	0.075	1
----------	----------------------	--------------	---------------	-------	---

Description	Order details		Bbn	Price	Price	Weight	Pack
	Type code	Order code	7612271	1 piece	group	1 piece	unit
			EAN			kg	pc.

Intermediate piece

Intermediate Piece 9mm	S800-IP9	2CCS800900R0031	208202	0.011	1
------------------------	-----------------	-----------------	---------------	-------	---

Padlock device

Padlock Lever Lock with 4mm hasp	S800-PLL	2CCS800900R0051	208189	0.0015	1
----------------------------------	-----------------	-----------------	---------------	--------	---

UL locking device

UL locking device	S800U-PLL	2CCS800017R0001	215057	0.03	2
-------------------	------------------	-----------------	---------------	------	---

Interchangeable adapter kit

Cage Terminal	S800N-CT2125	2CCS800900R0471	212049	0.03	2
Cage Terminal	S800N-CT4125	2CCS800900R0461	212032	0.06	4

Interchangeable adapter kit

Ring Terminal cable connection	S800-RT2125	2CCS800900R0161	208240	0.03	2
Ring Terminal cable connection	S800-RT4125	2CCS800900R0131	208219	0.06	4

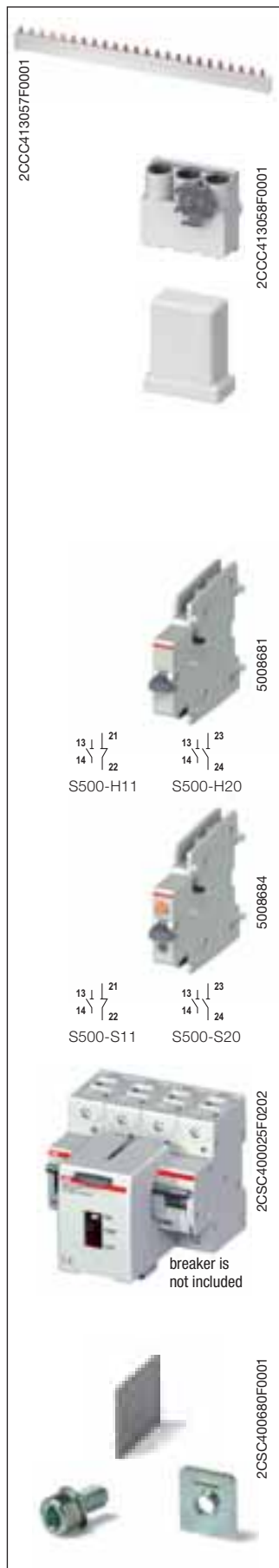

Busbar

Busbar 250A	S803-BB250	2CCS800900R0071	208288	1.5	1
-------------	-------------------	-----------------	---------------	-----	---

Supply block

Busbar Power Connector 120mm ²	S803-BBPC120	2CCS800900R0101	208301	0.46	1
---	---------------------	-----------------	---------------	------	---

Contact protection cap

Busbar Isolation Cap	S800-BBIC	2CCS800900R0081	208967	0.02	12
----------------------	------------------	-----------------	---------------	------	----

End cap

End cap	S800-END	2CCS800900R0091	208295	0.04	10
---------	-----------------	-----------------	---------------	------	----

S 800-ILS

Identification Labeling System 168x6x11.5mm	S800-ILS	2CCS800900R0121	208271	0.011	1
---	-----------------	-----------------	---------------	-------	---

Auxiliary elements and accessories for S500

Description	Order details	Bbn	Price	Price	Weight	Pack
	Type code	Order code	761227	group	1 piece	unit
			EAN		kg	pc.

Auxiliary contact

1 NO and 1 NC contact	S500-H11	2CCF008681R0001	0305506	0.06	1
2 NO contacts	S500-H20	2CCF008682R0001	0305513	0.06	1

Signal contact

1 NO and 1 NC contact	S500-S11	2CCF008684R0001	0305537	0.06	1
2 NO contacts	S500-S20	2CCF008685R0001	0305544	0.06	1

Remote switch unit

Remote switch unit	S500-RSU-H	2CCF017987R0001	1407780	0.3	1
--------------------	-------------------	-----------------	----------------	-----	---

Auxiliary elements and accessories for DDA 800 RCD-blocks

Description	Order details	Bbn	Price	Price	Weight	Pack
	Type code	Order code	8012542	group	1 piece	unit
			EAN		kg	pc.

Ring tongue terminal kit	DDA 800-RT	2CSB100913R0001	987406	0.01	1/12
--------------------------	-------------------	-----------------	---------------	------	------

The following chapter shows other protection devices in addition to the MCBs and RCDs ones.:

Surge protective devices

OVR: they are aimed at protecting electrical and electronic equipment against overvoltages and impulse currents (such as switching and lightning surges).

SPDs feature the following two functions:

- they limit overvoltage to a level acceptable by the equipment to be protected
- they divert surge currents

Fuse holders can protect against short circuits and overloads.

They are available in the following versions:

- E 90 fuse switch disconnectors that can disconnect circuits under load
- E 90 and E 930 fuse holders ranges suitable for use with gG and aM cylindrical fuse
- E 90 PV fuse disconnectors, designed for operating voltages of 1000 V d.c. with utilization category DC-20

Cylindrical fuses

gG and aM cylindrical fuse series to protect against short circuits and overloads. The range can cover a wide range of sizes, up to 690 V AC, and in PV version up to 1000 V DC. The E 9F series is the ideal completion for the ABB range of E 90 fuse switch disconnectors, E 9F fuseholders and E 930 fuse disconnectors.



Insulation monitoring devices

Moreover ABB offers a wide range of insulation monitoring devices:

For medical location

- ISOLTESTER/ SELVTESTER insulation monitoring devices for medical locations
- QSD remote signalling panel

For industrial environments

- ISL insulation monitoring devices

TI insulating transformers for medical use: permanently connected to an IT power supply system they provide galvanic separation between the distribution network and the loads.

QSO Complete electrical switchboard for medical locations : they are the ideal solution for distribution within group II medical locations, allowing monitoring of all network parameters.



Index

Technical features of OVR Surge Protective Devices	5/2
Selection tables	
OVR Surge Protective Devices.....	5/7
E 90 Fuse switch disconnectors, fuse holders and fuse disconnectors.....	5/12
E 930 Fuse disconnectors.....	5/19
E 9F cylindrical fuses.....	5/22
E 9F PV cylindrical fuses for photovoltaic applications	5/31
ILTS switch-disconnectors	5/33
D0 fuse carrier ISS	5/34
EPD24 electronic protection devices	5/36
ISOLTESTER-DIG insulation monitoring devices	5/40
SELVTESTER Insulation monitoring device for insulated networks at 24 V a.c./d.c.....	5/42
QSD-DIG 230/24 Remote signalling panel for insulation monitoring devices.....	5/42
TI insulating transformers for medical locations	5/44
QSO switchboards for medical locations	5/45
ISL industrial insulation monitoring devices.....	5/46

System **pro M compact®** Technical features

OVR Surge Protective Devices Type 1 & Type 1+2

SPDs



Type 1
OVR T1 ■ **25** ■ **TS**
Triggered spark-gap

TECHNICAL FEATURES

Technology

Electrical features

Standard		IEC 61643-1 / EN 61643-11					
Type / test class		1 / 1					
Poles		1P ■	1P ■ , 2P ■	3P ■	4P ■	1P+N ■	3P+N ■
Types of networks		IT - TNS	TNS-TNC	TNC	TNS	TT - TNS	TT - TNS
Type of current		A.C.					
Nominal voltage Un (L-N/L-L)	V	400	230	230/400		230/400	230/400
Max. cont. operating voltage Uc	V	440		255		-	-
Max. cont. operating voltage U _c (L-N / N-⊥)	V	-	-	-		255 / 255	255 / 255
Impulse current I _{imp} (10/350) per pole	kA	25		25		-	-
Impulse current I _{imp} (10/350) (L-N / N-⊥)	kA	-	-	-		25 / 50	25 / 100
I _{max} discharge current (8/20) per pole (I _{max})	kA	-	-	-		-	-
I _{max} discharge current (8/20) (L-N/N-terre) (I _{max})	kA	-	-	-		-	-
Nominal discharge current In (8/20) per pole	kA	25		25		-	-
Nominal discharge current In (8/20) (L-N / N-⊥)	kA	-	-	-		25 / 50	25 / 100
Voltage protection level Up	kV	2		2.5		-	-
Voltage protection level Up (L-N / N-⊥)	kV	-	-	-		2.5 / 2	2.5 / 2
Follow current interrupting rating I _f	kArms	50		50		-	-
Follow current interrupting rating I _f (L-N / N-⊥)	kArms	-	-	-		50 / 0.1	50 / 0.1
TOV (Temporary overvoltage) withstand U _T (5s.)	V	690		400		-	-
TOV (Temporary overvoltage) withstand U _T (L-N: 5s. / N-⊥ : 200ms.)	V	-	-	-		400 / 1200	400 / 1200
Continuous operating current I _c	mA					None	
Short-circuit withstand capability	kArms					50	
Load current I _{load} (for V-wiring)	A					125	
Maximum back-up fuse gG/gL						-	
Parallel Connection	A					≤125	
Serial Connection (V-wiring)	A					≤125	

Mechanical features

Stocking and operating temperature	°C					-40 to +80	
Degree of protection						IP 20	
Fire resistance according to UL 94						V0	
Colour of Housing						Polyarylamide grey RAL 7035	
State indicator						Option (with TS)	
TS remote indicator						Option (TS)	

Installation

Wire range (L, N, ⊥)							
solid wire	mm ²					2.5 ... 50	
stranded wire	mm ²					2.5 ... 35	
Stripping length (L, N, ⊥)	mm					15	
Tightening torque (L, N, ⊥)	Nm					3.5	

TECHNICAL FEATURES OF THE INTEGRATED AUXILIARY CONTACT (TS)

Electrical features

Contact complement		1NO (1 normally open contact), +1NC (1 normally closed contact)
Min. load		6 V D.C. - 10 mA
Max. load		250 V A.C. - 5 A
Continuous operating current	mA	10

Installation

Connection cross-section	mm ²	1.5
--------------------------	-----------------	-----

System **pro M compact®** Technical features

OVR Surge Protective Devices Type 1 & Type 1+2

SPDs



Type 1 OVR T1 25 255-7 Triggered spark-gap	Type1+2 OVR T1+2 25 255 TS Triggered spark-gap/varistor	Type 1+2 OVR T1+2 15 255-7 Triggered spark-gap	Type 1+2 OVR T1+2 7 275 s P Varistor
IEC 61643-1 / EN 61643-11 1 / I	IEC 61643-1 / EN 61643-11 1 / I	IEC 61643-1 / EN 61643-11 1 / I	IEC 61643-1 / EN 61643-11 1 / I
1P 1P TNS-TNC TT - TNS	3P+N 3N TNS - TNC	1P 1P TNS-TNC TT - TNS	1P 1P 3P 3P 4P 4L TNS-TNC TNC TNS TT - TNS TT - TNS
A.C.		A.C.	
230 230/400	230	230 230/400	230 230/400 230/400 230/400
255 -	255	255 -	275 275 275 / 255
- 255 / 255	-	- 255 / 255	-
25 -	25	15 -	7 -
- 25 / 100	-	- 15 / 50	- 7 / 12 7 / 12
- -	40	60 -	- 70 -
- -	-	- 60/60	- 70/70 70/70
25 -	25	15 -	6 -
- 25 / 100	-	- 15 / 50	- 6 6
2.5 -	1.5	1.5 -	0.9 -
- 2.5 / 1.5	-	- 1.5 / 1.5	- 0.9 / 1.4 0.9 / 1.5
7 -	15	7 -	NA -
- 7 / 0.1	-	- 7 / 0.1	- NA / 0.1 NA / 0.1
650 -	334	650 -	334 -
- 650 / 1200	-	- 650 / 1200	- 334 / 1200
< 2 (LED)	< 1 (Varistor leakage)	< 2 (LED)	< 1
50	50	50	50
-	125	-	-
≤125	≤125	≤125	≤50
NA	125	NA	NA
-40 to +80	-40 to +80	-40 to +80	-40 to +80
IP 20	IP 20	IP 20	IP 20
V0	V0	V0	V0
Polyarylamide grey RAL 7035	Polyarylamide grey RAL 7035	Polyarylamide grey RAL 7035	PC grey RAL 7035
Yes	Yes	Yes	Yes
No	Yes	No	No
2.5 ... 50	2.5 ... 50	2.5 ... 50	2.5 ... 25
2.5 ... 35	2.5 ... 35	2.5 ... 35	2.5 ... 16
15	15	15	12.5
3.5	3.5	3.5	2.8
-	1NO (1 normally open contact), +1NC (1 normally closed contact)	-	-
-	12V D.C. - 10 mA	-	-
-	250V A.C. - 1 A	-	-
-	None	-	-
-	1.5	-	-

5

System **pro M compact®** Technical features

OVR Surge Protective Devices Type 2

SPDs



TECHNICAL FEATURES

Type 2 (pluggable)
OVR T2 ■ ■ ■ (s) P (TS)
Varistor

Technology

Electrical features

Standard	IEC 61643-1 / EN 61643-11									
Type / test class	2 / II									
Poles	1P ■	3P ■	4P ■	3P+N ■	1P ■	3P ■	4P ■	1P+N ■	3P+N ■	
Types of networks	IT - TNS			TT - TNS			TNS-TNC			TT-TNS
Type of current	A.C.			A.C.			A.C.			A.C.
Nominal voltage Un (L-N/L-L)	V	400	230/400	230/400	230	230	400	230	230/400	
Max. cont. operating voltage Uc	V	440	440	-	275					
Max. cont. operating voltage Uc (L-N / N-PE)	V	-	-	440 / 255	-			275 / 255		
Max. cont. operating voltage Ucpv	V									
Maximum discharge current Imax (8/20) per pole	kA	15 40 70	40 70	- - -	15 40 70	40 70		- - -		
Maximum discharge current Imax (8/20) (L-N / N-PE)	kA	- - -	- - -	15 /70 40 /70 70 /70	- - -	- - -		15 /70 40 /70 70 /70		
Nominal discharge current In (8/20) (L-N / N-PE)	kA	5 20 30	20 30	- - -	5 20 30	30		- - -		
Nominal discharge current In (8/20) (L-N / N-PE)	kA	- - -	- - -	5/30 20/30 30/30	- - -	- - -		5/30 20/30 30/30		
Voltage protection level Up	kV	1.5 1.9 2	1.9 2	- - -	1 1.4 1.5			- - -		
Voltage protection level Up (L-N / N-PE)	kV	- - -	- - -	1.5/1.4 1.9/1.4 2/1.4	- - -	- - -		1/1.4 1.4/1.4 1.5/1.4		
Residual voltage Ures at 3 kA per pole	kV	1.4 1.4 1.3	1.4 1.3	- - -	0.9 0.9 0.85			- - -		
Residual voltage Ures at 3kA (L-N / N-PE)	kV	- - -	- - -	1.4/1.2 1.4/1.2 1.3/1.2	- - -	- - -		0.9/1.2 0.9/1.2 0.85/1.2		
Follow current interrupting rating Ifi	kArms	NA	NA	- - -	NA			- - -		
Follow current interrupting rating Ifi (L-N / N-PE)	kArms	-	-	NA / 0.1	-			NA / 0.1		
TOV (Temporary overvoltage) withstand Ut (5s.)	V	440 440 440	440	-	334			-		
TOV (Temporary overvoltage) withstand Ut (L-N: 5s./N-PE: 200ms)	V	-	-	440 / 1200	-			334 / 1200		
Continuous operating current Ic	mA	< 1	< 1	< 1	< 1			< 1		
Short-circuit withstand capability	kArms	50	50	50	50			50		
Short-circuit D.C. current withstand capability Iscwpv	A									
Disconnecter										
gG -gL fuse	A	≤50	≤50	≤50	≤50			≤50		
curve C circuit breaker	A	≤50	≤50	≤50	≤50			≤50		

Mechanical features

Stocking and operating temperature	°C	-40 to +80								
Degree of protection		IP 20								
Fire resistance according to UL 94		V0								
Material of Housing		PC grey RAL 7035								
Pluggable cartridge		Yes								
Integrated thermal disconnecter		Yes								
State indicator		Yes								
Safety reserve		Option (s)								
TS remote indicator		Option (TS)								

Installation

Wire range (L, N, \pm)										
solid wire	mm ²	2.5 ... 25								
stranded wire	mm ²	2.5 ... 16								
Stripping length (L, N, \pm)	mm	12.5								
Tightening torque (L, N, \pm)	Nm	2.8								

TECHNICAL FEATURES OF THE INTEGRATED AUXILIARY CONTACT (TS)

Electrical features

Contact complement		1NO (1 make contact), +1NC (1 normally closed contact)								
Min. load		12V D.C. - 10 mA								
Max. load		250V A.C. - 1 A								
Continuous operating current	mA	None								

Installation

Connection cross-section	mm ²	1.5								
--------------------------	-----------------	-----	--	--	--	--	--	--	--	--

System **pro M compact®** Technical features

OVR Surge Protective Devices Type 2

SPDs



Type 2 (non pluggable) OVR Plus N1 40	OVR Plus N3 15	OVR Plus N3 40	Type 2 (non pluggable) OVR T2 275 Varistor
IEC 61643-1 / EN 61643-11	EN 61643-11, IEC 61643-1	EN 61643-11, IEC 61643-1	IEC 61643-1 / EN 61643-11
2 / II	T2/II	T2/II	2 / II
1P+N N1	4	4	1P - 4P 4L
TT - TNS	TT-TNS	TT-TNS	TT* - TNS - TNC TNS
A.C.	A.C.	A.C.	A.C.
230/400	230/400	230/400	230 230/400
320	320	320	275
-	-	-	-
-	-	-	-
20 / 40	15/60	40/60	15 40
-	-	-	-
20	5/40	20/40	5 20
-	-	-	-
1.6 / 1.5	1.3/1.5	2/1.5	1 1.4
-	-	-	-
1/0.6	1.1/1	1.1/1	1 0.9
NA	-	-	NA
-	-	-	-
-	-	-	334
-	334/1200	334/1200	-
< 1	<0.1	<0.1	< 1
15	10	15	50
Integrated MCB	Integrated MCB	Integrated MCB	
-			≤50
-			≤50
-40 to +80			-40 to +80
IP 20			IP 20
V0			V0
PC grey RAL 7035			PC grey RAL 7035
No	No	No	No
Yes	Yes	Yes	Yes
Yes (MCB)	Yes (MCB)	Yes (MCB)	Yes
No	No	No	No
Optional (S2C-H6R) ABB (2CDS200912R0001)	Optional (S2C-H6R) ABB (2CDS200912R0001)	Optional (S2C-H6R) ABB (2CDS200912R0001)	No
2.5 ... 25	2.5 ... 25	2.5 ... 25	2.5 ... 25
2.5 ... 16	2.5 ... 16	2.5 ... 16	2.5 ... 16
11	11	11	12.5
2.8	2,8	2,8	2,8
-	-	-	-
-	-	-	-
-	-	-	-
-	-	-	-
-	-	-	-

5

System pro M compact® OVR Surge Protective Devices Type 2

SPDs



TECHNICAL FEATURES

Type 2 Photovoltaic OVR PV ■ ■ P (TS)

Telecom / Dataline OVR TC ■ VP

Technology	Varistor		Low current						
Electrical features									
Standard	IEC 61643-1 / EN 61643-11 / UTE C 61-740-51		IEC 61643-21						
Type / test class	2 / II		TC						
Poles	3		1 pair						
Types of networks	Photovoltaic		D.C.:						
Type of current	D.C.	D.C.	Low current						
Nominal voltage Un (L-N/L-L)	V	600	1000	6	12	24	48	200	200FR
Max. cont. operating voltage U _c	V	-	-	7	14	27	53	220	220
Max. cont. operating voltage U _{cpv}	V	670	1000	-					
Maximum discharge current I _{max} (8/20) per pole	kA	40	40	10					
Nominal discharge current I _n (8/20) per pole	kA	20	20	5					
Nominal discharge current I _n (8/20) (L-N / N-PE)	kA	-	-	-					
Voltage protection level U _p	kV	1.4	3.8	15	20	35	70	700	400
Residual voltage U _{res} at 3 kA per pole	kV								
Residual voltage U _{res} at 3kA (L-N / N-PE)	kV								
Follow current interrupting rating I _f	kArms	-	-	-					
Follow current interrupting rating I _f (L-N / N-PE)	kArms	-	-	-					
TOV (Temporary overvoltage) withstand U _t (5s.)	V	-	-	-					
TOV (Temporary overvoltage) withstand U _t (L-N: 5s./N-PE: 200ms)	V	-	-	-					
Continuous operating current I _c	mA	< 0.05	< 0.05	140					
Short-circuit withstand capability	kArms	-	-	-					
Short-circuit D.C. current withstand capability I _{scwpv}	A	100	100	-					
Disconnecter		If DC current >100 A	If DC current >100 A						
gG -gL fuse	A	E90PV	E90PV	-					
Circuit breaker	A	S802PV-S10	S804PV-S10	-					
Mechanical features									
Stocking and operating temperature	°C	-40 to +80		-40 to +80					
Degree of protection		IP 20		IP 20					
Fire resistance according to UL 94		V0		V0					
Material of Housing		PC grey RAL 7035		PC grey RAL 7035					
Pluggable cartridge		Yes		Yes					
Integrated thermal disconnecter		Yes (specific PV)		Yes	Yes	Yes	Yes	No	Yes
State indicator		Yes		No					
Safety reserve		No		No					
TS remote indicator		Yes (TS option)		No					
Installation									
Wire range (L, N, \pm)									
solid wire	mm ²	2.5 ... 25		0.5 ... 2.5					
stranded wire	mm ²	2.5 ... 16		0.5 ... 2.5					
Stripping length (L, N, \pm)	mm	12.5		-					
Tightening torque (L, N, \pm)	Nm	2.8		-					

TECHNICAL FEATURES OF THE INTEGRATED AUXILIARY CONTACT (TS)

Electrical features		
Contact complement		-
Min. load		-
Max. load		-
Continuous operating current	mA	-
Installation		
Connection cross-section	mm ²	-

T1



2CSC400306F0201

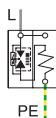

2CSC400315F0201

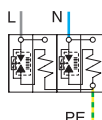

2CSC400315F0201

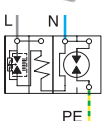

2CSC400316F0201

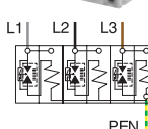

2CSC400313F0201

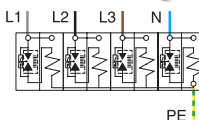

2CSC400313F0201

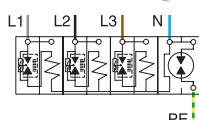

Surge Protective Devices, Type 1 / Type 1+2

Function: Type 1 and Type 1+2 SPDs are Lightning Current Arresters. They can handle and divert high energy from lightning.

They are necessary when the installation is exposed to direct lightning (for example when the building is equipped with external lightning protection system or powered by aerial lines). They shall be installed at the line entrance of the installation (meter board or main distribution board).

ABB Type 1 and Type 1+2 SPDs are tested with wave-shape 10/350. Additionally, Type 1+2 SPDs are also tested with wave-shape 8/20 to guarantee protection against overvoltage of low energy from remote lightning stroke or from switching operations.

ABB Type 1+2 SPDs feature a better voltage protection level (Up) than Type 1 SPDs which make them suitable for protection of most of electrical and electronic equipment.

Type 1 Neutral SPDs are for TT networks when used in combination with phase SPDs Type 1 or Type 1+2.

Application: residential, commercial, industrial

Standard: IEC 61643-1 / EN 61643-11

10/350 current wave for SPDs Type 1, 10/350 & 8/20 for SPDs Type 1+2, spark-gap technology (no blow-out).

Nb. of poles	Impulse current (10/350) kA	Follow current interrupting level If ₁ kArms	Voltage protection level Up kV	Nominal protection voltage Un V	Max. operating voltage Uc V	Order details	Bbn	Price	Price group	Weight	Pack
						Type code				kg	pc.

Type 1 (If₁ = 50 kA)

TNS, TNC

1	25	50	2.5	230	255	OVR T1 25 255	2CTB815101R0100	510877		0.25	1
---	----	----	-----	-----	-----	----------------------	-----------------	---------------	--	------	---

IT (230 / 400 V), TNC (400 / 690 V)

1	25	50	2	400	440	OVR T1 25 440-50	2CTB815101R9300	514929		0.27	1
---	----	----	---	-----	-----	-------------------------	-----------------	---------------	--	------	---

TNS (1 Ph+N)

2	25 ⁽¹⁾	50	2.5	230	255	OVR T1 2L 25 255	2CTB815101R1200	510891		0.50	1
2	25 ⁽¹⁾	50	2.5	230	255	OVR T1 2L 25 255 TS⁽³⁾	2CTB815101R1100	510945		0.60	1

TT (1 Ph+N), TNS

1+N	25/50 ⁽¹⁾	50/0.1 ⁽¹⁾	2.5/2 ⁽¹⁾	230	255/255 ⁽¹⁾	OVR T1 1N 25 255	2CTB815101R1500	510921		0.50	1
1+N	25/50 ⁽¹⁾	50/0.1 ⁽¹⁾	2.5/2 ⁽¹⁾	230	255/255 ⁽¹⁾	OVR T1 1N 25 255 TS⁽³⁾	2CTB815101R1000	510976		0.60	1

TNC

3	25 ⁽²⁾	50	2.5	230	255	OVR T1 3L 25 255	2CTB815101R1300	510907		0.75	1
3	25 ⁽²⁾	50	2.5	230	255	OVR T1 3L 25 255 TS⁽³⁾	2CTB815101R0600	510952		0.85	1

TNS (3 Ph+N)

4	25 ⁽²⁾	50	2.5	230	255	OVR T1 4L 25 255	2CTB815101R1400	510914		1.00	1
4	25 ⁽²⁾	50	2.5	230	255	OVR T1 4L 25 255 TS⁽³⁾	2CTB815101R0800	510969		1.10	1

TT (3 Ph+N), TNS

3+N	25/100 ⁽¹⁾	50/0.1 ⁽¹⁾	2.5/2 ⁽¹⁾	230	255/255 ⁽¹⁾	OVR T1 3N 25 255	2CTB815101R1600	510938		1.00	1
3+N	25/100 ⁽¹⁾	50/0.1 ⁽¹⁾	2.5/2 ⁽¹⁾	230	255/255 ⁽¹⁾	OVR T1 3N 25 255 TS⁽³⁾	2CTB815101R0700	510983		1.10	1

(1) L-N / N-PE.

(2) per pole.

(3) TS: telesignal contact for remote control of the status of the Surge Protective Device.

5

T1

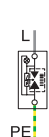

2CSC400297F0201



2CSC400299F0201



2CSC400299F0201

T1+T2

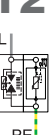

2CSC400300F0201

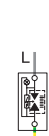

2CSC400297F0201



2CSC400299F0201

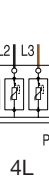

2CSC400299F0201

T1 (N+PE)



2CSC400306F0201



Nb. of poles	Impulse current limp (10/350) kA	Follow current 75% If _f kArms	Voltage protection level Up kV	Nominal voltage Un V	Max. cont. operating voltage Uc V	Order details	Bbn	Price	Price group	Weight	Pack
						Type code	Order code	EAN	kg	pc.	

Type 1 (Ifi = 7 kA)

TNS, TNC

1	25	7	2.5	230	255	OVR T1 25 255-7	2CTB815101R8700	514110		0.12	1
---	----	---	-----	-----	-----	------------------------	-----------------	---------------	--	------	---

TT (3 Ph+N), TNS

3+N	25/100 ⁽¹⁾	7/0.1 ⁽¹⁾	2.5/1.5 ⁽¹⁾	230	255/255 ⁽¹⁾	OVR T1 3N 25 255-7	2CTB815101R8800	514127		0.60	1
-----	-----------------------	----------------------	------------------------	-----	------------------------	---------------------------	-----------------	---------------	--	------	---

OVR HL (Type 1 with varistors)

TT, TNS, TNC, IT

1	15	NA	1.4	400	440	OVR HL 15 440 s P TS	2CTB815201R0800	509802		0.25	1
---	----	----	-----	-----	-----	-----------------------------	-----------------	---------------	--	------	---

TNS

2	15	NA	1.4	400	440	OVR HL 2L 15 440 s P TS	2CTB815303R0400	509826		0.5	1
---	----	----	-----	-----	-----	--------------------------------	-----------------	---------------	--	-----	---

Type 1+2 (limp = 25 kA)

TNS, TNC

1	25	15	1.5	230	255	OVR T1+2 25 255 TS⁽³⁾	2CTB815101R0300	510884		0.30	1
---	----	----	-----	-----	-----	---	-----------------	---------------	--	------	---

Type 1+2 (limp = 15 kA)

TNS, TNC

1	15	7	1.5	230	255	OVR T1+2 15 255-7	2CTB815101R8900	514134		0.12	1
---	----	---	-----	-----	-----	--------------------------	-----------------	---------------	--	------	---

TT (3 Ph+N), TNS

3+N	15/50 ⁽¹⁾	7/0.1 ⁽¹⁾	1.5/1.5 ⁽¹⁾	230	255/255 ⁽¹⁾	OVR T1+2 3N 15 255-7	2CTB815101R9000	514141		0.60	1
-----	----------------------	----------------------	------------------------	-----	------------------------	-----------------------------	-----------------	---------------	--	------	---

Type 1+2 (limp = 7 kA)

1	7	0	0.9	230	275	OVR T1+2 7 275s P	2CTB815101R3900	513403		0.12	1
2	7	0	0.9/1.4	230	275	OVR T1+2 1N 7 275s P	2CTB815302R1000	515728		0.27	1
4	7	0	0.9/1.4	230	275	OVR T1+2 3N 7 275s P	2CTB815502R1000	515735		0.5	1
3	7	0	0.9	230	275	OVR T1+2 3L 7 275s P	2CTB815101R4000	513410		0.4	1
4	7	0	0.9	230	275	OVR T1+2 4L 7 275s P	2CTB815101R4100	513427		0.5	1
-	7	0	0.9	230	275	OVR T1+2 7 275s C	2CTB815101R3800	513458		0.1	1
-	7	0	1.4	230	275	OVR T1+2 70 NC	2CTB815101R5100	515742		0.05	1

Type 1 Neutral

For TT networks when used in combination with phase SPDs Type 1 or Type 1+2

1	25	0.1	< 4	-	690	OVR T1 25 N	2CTB815101R9700	517043		0.25	1
1	50	0.1	1.5	-	255	OVR T1 50 N	2CTB815101R0400	510853		0.25	1
1	100	0.1	2	-	255	OVR T1 100 N	2CTB815101R0500	510860		0.25	1

(1) L-N / N-⊥.

(3) TS: telesignal contact for remote control of the status of the Surge Protective Device.

Bus bar

For TT (3Ph+N) networks, this bus bar can be used to connect four single pole Type 1 & Type 1+2 SPDs (except for Type 1 with Ifi = 7 kA)

-	-	-	-	-	-	Bus bar 3N	2CTB815102R0400	516091		0.005	50
---	---	---	---	---	---	-------------------	-----------------	---------------	--	-------	----

T2

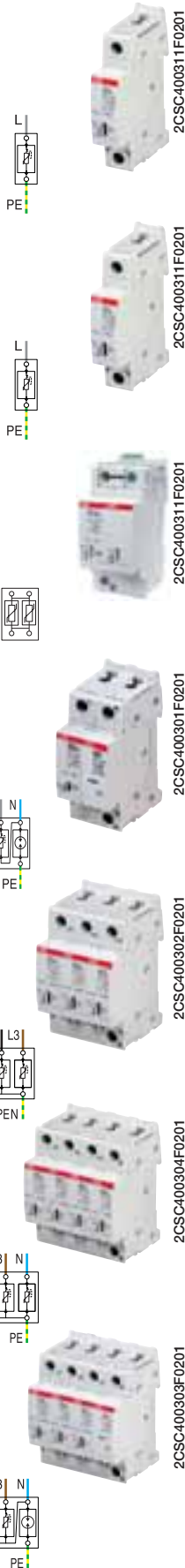

Surge Protective Devices, Type 2

Function: Type 2 SPDs are surge arresters. They can handle energy from distant/ indirect lightning strikes or from switching operations. Type 2 SPDs can not discharge high energies from direct lightning like Type 1 SPDs but they feature lower protection level (Up). They are recommended at the incoming of installation for locations with no exposure to direct lightning impulses.

Application: residential, commercial, industrial

Standard: IEC 61643-1 / EN 61643-11

8/20 current wave, varistor technology

Nb. of poles	Maxi. discharge current I _{max} (8/20) kA	Nominal discharge current I _n (8/20) kA	Voltage protection level U _p kV	Nom. voltage U _n V	Max. cont. operating voltage U _c V	Order details	Bbn 3660308	Price 1 piece	Price group	Weight 1 piece	Pack unit
						Type code	Order code	EAN			

Type 2 (pluggable)

TNS, TNC

1	15	5	1.0	230	275	OVR T2 15 275 P	2CTB803851R2400	512840		0.12	1
1	40	20	1.4	230	275	OVR T2 40 275 P	2CTB803851R2300	512833		0.12	1
1	40	20	1.4	230	275	OVR T2 40 275s P	2CTB803851R2000	512826		0.12	1
1	40	20	1.4	230	275	OVR T2 40 275 P TS	2CTB803851R1700	514363		0.14	1
1	40	20	1.4	230	275	OVR T2 40 275s P TS ⁽³⁾	2CTB803851R1400	512802		0.15	1
1	70	30	1.5	230	275	OVR T2 70 275 s P	2CTB803851R1900	512819		0.12	1
1	70	30	1.5	230	275	OVR T2 70 275s P TS ⁽³⁾	2CTB803851R1300	512796		0.15	1

IT, TNS

1	15	5	1.5	400	440	OVR T2 15 440 P	2CTB803851R1100	512772		0.12	1
1	40	20	1.9	400	440	OVR T2 40 440 P	2CTB803851R1200	512789		0.12	1
1	40	20	1.9	400	440	OVR T2 40 440 s P	2CTB803851R0800	512765		0.12	1
1	40	20	1.9	400	440	OVR T2 40 440 P TS	2CTB803851R0500	514370		0.14	1
1	40	20	1.9	400	440	OVR T2 40 440s P TS ⁽³⁾	2CTB803851R0200	512741		0.15	1
1	70	30	2	400	440	OVR T2 70 440 s P	2CTB803851R0700	512758		0.12	1
1	70	30	2.0	400	440	OVR T2 70 440s P TS ⁽³⁾	2CTB803851R0100	512734		0.15	1

TNS, TNC, IT

1	120	60	2.5	400	440	OVR T2 120 440s P TS ⁽³⁾	2CTB803951R1300	517036		0.12	1
---	-----	----	-----	-----	-----	-------------------------------------	-----------------	--------	--	------	---

TT, TN-S (1 Ph+N) (Common + Differential mode protection)

1+N	15/70 ⁽¹⁾ 5 ⁽¹⁾	1.0/1.4 ⁽¹⁾	230	275/255 ⁽¹⁾	OVR T2 1N 15 275 P	2CTB803952R1200	513106		0.22	1
1+N	40/70 ⁽¹⁾ 20 ⁽¹⁾	1.4/1.4 ⁽¹⁾	230	275/255 ⁽¹⁾	OVR T2 1N 40 275 P	2CTB803952R1100	513250		0.27	1
1+N	40/70 ⁽¹⁾ 20 ⁽¹⁾	1.4/1.4	230	275/255	OVR T2 1N 40 275s P	2CTB803952R0800	513090		0.27	1
1+N	40/70 ⁽¹⁾ 20 ⁽¹⁾	1.4/1.4 ⁽¹⁾	230	275/255 ⁽¹⁾	OVR T2 1N 40 275 P TS	2CTB803952R0500	514387		0.27	1
1+N	40/70 ⁽¹⁾ 20 ⁽¹⁾	1.4/1.4 ⁽¹⁾	230	275/255 ⁽¹⁾	OVR T2 1N 40 275s P TS ⁽³⁾	2CTB803952R0200	513076		0.27	1
1+N	70/70 ⁽¹⁾ 30 ⁽¹⁾	1.5/1.4	230	275/255	OVR T2 1N 70 275 s P	2CTB803952R0700	513083		0.27	1
1+N	70/70 ⁽¹⁾ 30 ⁽¹⁾	1.5/1.4 ⁽¹⁾	230	275/255 ⁽¹⁾	OVR T2 1N 70 275s P TS ⁽³⁾	2CTB803952R0100	513069		0.27	1

TNC (common mode protection)

3	15 ⁽²⁾ 5 ⁽²⁾	1.0	230	275	OVR T2 3L 15 275 P	2CTB803853R3400	512987		0.35	1
3	40 ⁽²⁾ 20 ⁽²⁾	1.4	230	275	OVR T2 3L 40 275 P	2CTB803853R2400	513366		0.35	1
3	40 ⁽²⁾ 20 ⁽²⁾	1.4	230	275	OVR T2 3L 40 275sP	2CTB803853R2200	512963		0.35	1
3	40 ⁽²⁾ 20 ⁽²⁾	1.4	230	275	OVR T2 3L 40 275 P TS	2CTB803853R2500	514400		0.40	1
3	40 ⁽²⁾ 20 ⁽²⁾	1.4	230	275	OVR T2 3L 40 275s P TS ⁽³⁾	2CTB803853R2300	512970		0.40	1
3	70 ⁽²⁾ 30 ⁽²⁾	1.5	230	275	OVR T2 3L 70 275 s P	2CTB803853R4100	512994		0.35	1
3	70 ⁽²⁾ 30 ⁽²⁾	1.5	230	275	OVR T2 3L 70 275s P TS ⁽³⁾	2CTB803853R4400	513007		0.40	1

TNS (3 Ph+N)

4	15 ⁽²⁾ 5 ⁽²⁾	1.0	230	275	OVR T2 4L 15 275 P	2CTB803853R6000	513038		0.45	1
4	40 ⁽²⁾ 20 ⁽²⁾	1.4	230	275	OVR T2 4L 40 275 P	2CTB 803853R5600	513274		0.45	1
4	40 ⁽²⁾ 20 ⁽²⁾	1.4	230	275	OVR T2 4L 40 275sP	2CTB803853R5400	513021		0.45	1
4	40 ⁽²⁾ 20 ⁽²⁾	1.4	230	275	OVR T2 4L 40 275 P TS	2CTB803853R5200	514417		0.50	1
4	40 ⁽²⁾ 20 ⁽²⁾	1.4	230	275	OVR T2 4L 40 275s P TS ⁽³⁾	2CTB803853R5000	513014		0.50	1
4	70 ⁽²⁾ 30 ⁽²⁾	1.5	230	275	OVR T2 4L 70 275 s P	2CTB803919R0200	513045		0.45	1
4	70 ⁽²⁾ 30 ⁽²⁾	1.5	230	275	OVR T2 4L 70 275s P TS ⁽³⁾	2CTB803919R0400	513052		0.50	1

TT, TN-S (3 Ph+N) (Common + Differential mode protection)

3+N	15/70 ⁽¹⁾ 5 ⁽¹⁾	1.0/1.4 ⁽¹⁾	230	275/255 ⁽¹⁾	OVR T2 3N 15 275 P	2CTB803953R1200	513151		0.45	1
3+N	40/70 ⁽¹⁾ 20 ⁽¹⁾	1.4/1.4 ⁽¹⁾	230	275/255 ⁽¹⁾	OVR T2 3N 40 275 P	2CTB803953R1100	513267		0.45	1
3+N	40/70 ⁽¹⁾ 20 ⁽¹⁾	1.4/1.4	230	275/255	OVR T2 3N 40 275sP	2CTB803953R0800	513144		0.45	1
3+N	40/70 ⁽¹⁾ 20 ⁽¹⁾	1.4/1.4 ⁽¹⁾	230	275/255 ⁽¹⁾	OVR T2 3N 40 275 P TS	2CTB803953R0500	514394		0.50	1
3+N	40/70 ⁽¹⁾ 20 ⁽¹⁾	1.4/1.4 ⁽¹⁾	230	275/255 ⁽¹⁾	OVR T2 3N 40 275s P TS ⁽³⁾	2CTB803953R0200	513120		0.50	1
3+N	70/70 ⁽¹⁾ 30 ⁽¹⁾	1.5/1.4	230	275/255	OVR T2 3N 70 275 s P	2CTB803953R0700	513137		0.45	1
3+N	70/70 ⁽¹⁾ 30 ⁽¹⁾	1.5/1.4 ⁽¹⁾	230	275/255 ⁽¹⁾	OVR T2 3N 70 275s P TS ⁽³⁾	2CTB803953R0100	513113		0.50	1

(1) L-N / N-PE. (2) per pole. (3) TS: tele-signal contact for remote control of the status of the Surge Protective Device. The safety reserve(s) ensures a preventive maintenance of the installation.
TT*: in TT network for L/N protection only

T2

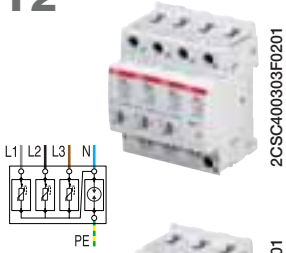

2CSC400303F0201



2CSC400309F0201

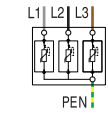

2CSC400309F0201

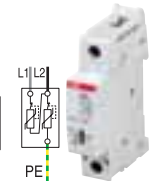
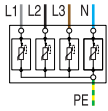

2CSC400309F0201

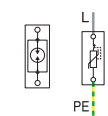

2CSC400310F0201



2CSC400307F0201



2CSC400310F0201



T2+T3

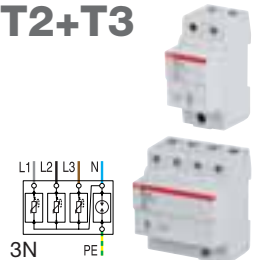

3N

Nb. of poles	Maxi. discharge current I _{max} (8/20) kA	Nominal discharge current I _n (8/20) kA	Voltage protection level Up kV	Voltage protection level at U _{oc} kV	Nom. voltage Un V	Max. cont. operating voltage U _c V	Order details	Bbn	Price 1 piece	Price group	Weight 1 piece	Pack unit
							Type code	Order code	EAN			
											kg	ppc.

TT (3 Ph+N), TNS

3+N	15	5	1.5/1.4 (1)	230	440/255 ⁽¹⁾	440	OVR T2 3N 15-440 P	2CTB803953R1300	3660308516800		0.45	1
3+N	40	20	1.9/1.4 (1)	230	440/255 ⁽¹⁾	440	OVR T2 3N 40-440 P	2CTB803953R1400	3660308516817		0.45	1
3+N	40	20	1.9/1.4 (1)	230	440/255 ⁽¹⁾	440	OVR T2 3N 40-440 P TS⁽⁸⁾	2CTB803953R1500	3660308516824		0.45	1
3+N	40	20	1.9/1.4 (1)	230	440/255 ⁽¹⁾	440	OVR T2 3N 40-440s P TS⁽⁸⁾	2CTB803953R1600	3660308516831		0.45	1
3+N	70	30	2/1.4 (1)	230	440/255 ⁽¹⁾	440	OVR T2 3N 70-440s P	2CTB803953R1700	3660308516848		0.45	1
3+N	70	30	2/1.4 (1)	230	440/255 ⁽¹⁾	440	OVR T2 3N 70-440s P TS⁽⁸⁾	2CTB803953R1800	3660308516855		0.45	1

TNC (3 Ph), IT

3	40	20	1.9	230	440	440	OVR T2 3L 40-440 P	2CTB803853R2600	516879		0.35	1
3	40	20	1.9	230	440	440	OVR T2 3L 40-440 P TS	2CTB803853R2700	516886		0.40	1
3	70	30	2	230	440	440	OVR T2 3L 70-440s P	2CTB803853R4200	516893		0.35	1
3	70	30	2	230	440	440	OVR T2 3L 70-440s P TS	2CTB803853R4300	516909		0.40	1

TNS, IT (3 Ph+N)

4	40	20	1.9/1.4 ⁽¹⁾	230	440	440	OVR T2 4L 40-440 P	2CTB803853R5100	516916		0.45	1
4	40	20	1.9/1.4 ⁽¹⁾	230	440	440	OVR T2 4L 40-440 P TS	2CTB803853R5300	516923		0.50	1
4	70	30	2/1.4 ⁽¹⁾	230	440	440	OVR T2 4L 70-440s P	2CTB803853R7000	516930		0.45	1
4	70	30	2/1.4 ⁽¹⁾	230	440	440	OVR T2 4L 70-440s P TS	2CTB803853R7100	516947		0.50	1

Type 2 Neutral

1	70	30	1.4	230	255	255	OVR T2 70 N P	2CTB803953R1900	516862			
---	----	----	-----	-----	-----	-----	----------------------	-----------------	--------	--	--	--

OVR Type 2 Special 24/48V AC & DC

These type 2 SPD's can be used in very low voltages & data lines for current higher than 140mA.

1	15	5	0.3	57	75	75	OVR 15 75 P	2CTB813851R2800	504647		0.12	1
1	15	5	0.3	57	75	75	OVR 15 75 P TS	2CTB813851R2700	504630		0.13	1
2	15	5	0.3/0.6	57	75	75	OVR 2 15 75 P	2CTB813852R1700	504609		0.22	1
2	15	5	0.3/0.6	57	75	75	OVR 2 15 75 P TS	2CTB813852R1600	504593		0.23	1
2	15	5	0.3/0.6	57	75	75	OVR 2 15 75s P TS	2CTB813852R1300	504579		0.23	1

Back-up protection by fuse: 16A gG under AC, 16A gR under DC

Replacement cartridges for Surge Protective Devices Type 2

Phase cartridge, 75 V

-	15	5	0.3	57	75	75	OVR 15 75 C	2CTB813854R1400	508892		0.10	1
---	----	---	-----	----	----	----	--------------------	-----------------	--------	--	------	---

Phase cartridge, 275 V

-	15	5	1.0	230	275	275	OVR T2 15 275 C	2CTB803854R1200	513168		0.10	1
-	40	20	1.4	230	275	275	OVR T2 40 275 C	2CTB803854R1000	513182		0.10	1
-	40	20	1.4	230	275	275	OVR T2 40 275s C⁽¹⁾	2CTB803854R0900	513199		0.10	1
-	70	30	1.5	230	275	275	OVR T2 70 275s C⁽¹⁾	2CTB803854R0700	513229		0.10	1

Neutral cartridge for products OVR T2 1N (..) & OVR T2 3N (..), 275 V

-	70	30	1.4	-	440	440	OVR T2 70 N C	2CTB803854R0000	513243		0.05	1
---	----	----	-----	---	-----	-----	----------------------	-----------------	--------	--	------	---

Phase cartridge, 440 V

-	15	5	1.5	400	440	440	OVR T2 15 440 C	2CTB803854R0600	513175		0.10	1
-	40	20	1.9	400	440	440	OVR T2 40 440 C	2CTB803854R0400	513205		0.10	1
-	40	20	1.9	400	440	440	OVR T2 40 440s C⁽¹⁾	2CTB803854R0300	513212		0.10	1
-	70	30	2.0	400	440	440	OVR T2 70 440s C⁽¹⁾	2CTB803854R0100	513236		0.10	1

Nb. of poles	Maxi. discharge current I _{max} (8/20) kA	Nominal discharge current I _n (8/20) kA	Voltage protection level Up kV	Voltage protection level at U _{oc} kV	Voltage wave combination U _{oc} kV	Nom. voltage Un V	Max. cont. operating voltage U _c V	Order details	Bbn	Price 1 piece	Price group	Weight 1 piece	Pack unit
								Type code	Order code	EAN			
												kg	ppc.

Type 2 & Type 3 (non pluggable)

1+N	10	3	0.9/1.4	0.9/1.4	6	230	275	OVR 1N 10 275	2CTB813912R1000	509208		0.25	1
3+N	10	3	0.9/1.4	0.9/1.4	6	230	275	OVR 3N 10 275	2CTB813913R1000	509215		0.45	1

T2



2CSC400309F0201

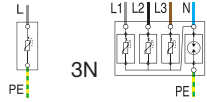

3N

auto-protected



2CSC400309F0201

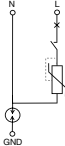

TC



2CSC400309F0201

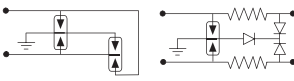

OVR TC P 200 V
in parallel

OVR TC P / xx V /
200 FR in series

PV



2CSC400309F0201

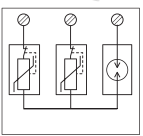

OVR PV 600 V

Nb. of poles	Maxi. discharge current I _{max} (8/20) kA	Nominal discharge current I _n (8/20) kA	Voltage protection level U _p kV	Nom. voltage U _n V	Max. cont. operating voltage U _c V	Order details	Bbn 3660308	Price 1 piece	Price group	Weight 1 piece	Pack unit
						Type code	Order code	EAN		kg	ppc.

Type 2 (non pluggable)

1	15	5	1	230	275	OVR T2 15 275	2CTB804200R0100	514882		0.12	1
1	40	20	1,4	230	275	OVR T2 40 275	2CTB804201R0100	514103		0.12	1
4	15	5	1	230	275	OVR T2 4L 15 275	2CTB804600R0500	515612		0.45	1
4	40	20	1.4	230	275	OVR T2 4L 40 275	2CTB804601R0500	515988		0.45	1

OVR Plus with integrated end of life protection (auto-protected)

N+1	40 ¹ /40	20/40	1.6/1.5	230	320/255	OVR Plus N1 40	2CTB803701R0100	517005		0.26	1
N+3	15/60	5/40	1.3/1.5	230/400	320	OVR Plus N3 15	2CTB803701R0400	517081		0.79	1
N+3	40/60	20/40	2/1.5	230/400	320	OVR Plus N3 40	2CTB803701R0300	517074	NEW	0.79	1

*I_m = I_{max} MOV

Surge Protective Devices, Low current

The transmission line pluggable surge arresters (OVR TC P) provide protection against transient overvoltages for equipment connected to telephone lines (digital or analog), computer links or current loops, for applications such as RS-485, or 4-20 mA.

1	10	5	0.015	6		OVR TC 6V P	2CTB804820R0000	515230		0.05	1
1	10	5	0.02	12		OVR TC 12V P	2CTB804820R0100	515247		0.05	1
1	10	5	0.035	24		OVR TC 24V P	2CTB804820R0200	515254		0.05	1
1	10	5	0.07	48		OVR TC 48V P	2CTB804820R0300	515261		0.05	1
1	10	5	0.7	200		OVR TC 200V P	2CTB804820R0400	515278		0.05	1
1	10	5	0.3	200		OVR TC 200FR P	2CTB804820R0500	515285		0.05	1
-	10	5	0.015	7		OVR TC 6V C	2CTB804821R0000	515292		0.02	1
-	10	5	0.02	14		OVR TC 12V C	2CTB804821R0100	515308		0.02	1
-	10	5	0.035	27		OVR TC 24V C	2CTB804821R0200	515315		0.02	1
-	10	5	0.07	53		OVR TC 48V C	2CTB804821R0300	515322		0.02	1
-	10	5	0.7	220		OVR TC 200V C	2CTB804821R0400	515339		0.02	1
-	10	5	0.3	220		OVR TC 200FR C	2CTB804821R0500	515346		0.02	1
1	-	-	-	-	-	Base OVR TC RJ11	2CTB804840R1000	515599		0.02	1
2	-	-	-	-	-	Base OVR TC RJ45	2CTB804840R1100	515605		0.04	1

Surge Protective Devices, Photovoltaic

The specific OVR PV range offer a safe and efficient protection against transient overvoltages for equipments on photovoltaic installations.

The OVR PV range comply with the UTE C 61-740-51 on surge protective devices connected to photovoltaic generators.

Nb. of poles	Maxi. discharge current I _{max} (8/20) kA	Nominal discharge current I _n (8/20) kA	Voltage protection level U _p kV	Max. Cont. Voltage V	Short circuit DC current I _{scwpv} A	Order details	Bbn 3660308	Price 1 piece	Price group	Weight 1 piece	Pack unit
						Type code	Order code	EAN		kg	ppc.
3	40	20	1.4	670	100	OVR PV 40 600 P	2CTC803953R5300	516510		0.27	1
3	40	20	1.4	670	100	OVR PV 40 600 P TS	2CTC803953R5400	516527		0.27	1
3	40	20	3.8	1000	100	OVR PV 40 1000 P	2CTC803953R6400	516534		0.27	1
3	40	20	3.8	1000	100	OVR PV 40 1000 P TS	2CTC803953R6500	516541		0.27	1

Replacement cartridges for Surge Protective Devices OVR PV

-	40	20	1.4	670	100	OVR PV 40-600 C	2CTB803950R0000	516558		0.10	1
-	40	20	1.9	1000	100	OVR PV 40-1000 C	2CTB803950R0100	516565		0.10	1
-	70	30	1.4	1000	-	OVR PV MC*	2CTB803950R0300	516756		0.10	1

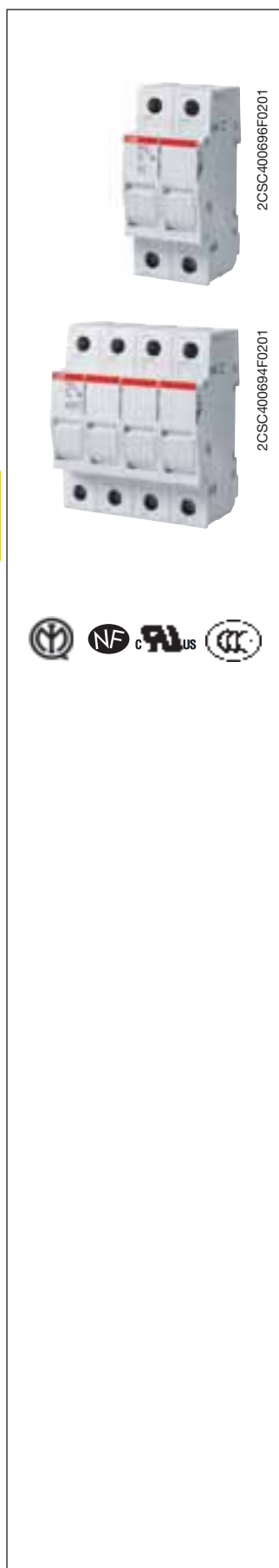

E 90 fuse switch disconnectors

E 90 series fuse switch disconnectors are designed for switching circuits under load, providing protection against short circuits and overloads. The case is made of self-extinguishing thermoplastic material resistant to high temperatures (all materials are UL listed) while the contact clips are in silver plated copper.

E 90 fuse switch disconnectors can be sealed or padlocked to ensure operator safety during maintenance. Versions with blown fuse indicator allow to check whether the fuse is still working correctly or not. For easy and quick installation E 90 range is totally compatible with connecting bars, terminals and caps of S 200 MCBs.

Thanks to cURus approval, they can be installed in UL certified machines.

E 90 fuse switch disconnectors for 10.3 x 38 mm fuses (AC-22B)



Poles	Rated current In	Modules	Order details Type code	Order code	Bbn 8012542 EAN	Price 1 piece	Price group	Weight 1 piece kg	Pack unit pc.
1	32	1	E 91/32	2CSM200923R1801	009238			0.061	6
1	32	1	E 91/32s	2CSM202483R1801	024835			0.062	6
1+N	32	2	E 91N/32	2CSM200893R1801	008934			0.130	3
2	32	2	E 92/32	2CSM200883R1801	008835			0.122	3
3	32	3	E 93/32	2CSM204753R1801	047537			0.183	2
3+N	32	4	E 93N/32	2CSM204733R1801	047339			0.252	1
4	32	4	E 94/32	2CSM204723R1801	047230			0.244	1

s: version with blown fuse indicator light

E 90 fuse switch disconnectors for 8.5 x 31.5 mm fuses (AC-22B)

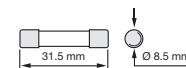

1	20	1	E 91/20	2CSM200983R1801	009832			0.061	6
1	20	1	E 91/20s	2CSM202423R1801	024231			0.062	6
2	20	2	E 92/20	2CSM200953R1801	009535			0.122	3
3	20	3	E 93/20	2CSM200943R1801	009436			0.183	2

s: version with blown fuse indicator light

Technical features

Type		E 90/20	E 90/32
Fuse	[mm]	8 x 31	10 x 38
Current type			a.c. / d.c.
Rated frequency	[Hz]		= / 50-60
Rated current	[A]	20	32
Max power dissipation	[W]	2.5	3
Tightening torque	[Nm]		PZ2 2-2.5
Terminal cross section	[mm ²]		25
Protection degree			IP20
Can be padlocked (open)			■
Can be sealed (closed)			■

IEC 60947-3

Rated operating voltage	[V]	400	400
Utilization category			AC-22B
Markings			IMQ, NF

Alternate current characteristics according to IEC 60947-3

Rated operating voltage	[V]	400	690
Utilization category			AC-22B

Direct current characteristics according to IEC 60947-3

Rated operating voltage	[V]	400	690
Utilization category			DC-20B*

IEC 60269-1

Rated a.c. voltage	[V]	400	690
Rated d.c. voltage	[V]	400	690

IEC 60269-2

Fuse system			F
Rated a.c. voltage	[V]	400	690
Rated d.c. voltage	[V]	250	440
Breaking capacity	[kA]	200 (a.c.) – 100 (d.c.)	

IEC 60269-3

Fuse system			B
Rated a.c. voltage	[V]		400

IEC 60269-4

Fuse system			F
Rated a.c. voltage	[V]	400	690
Rated d.c. voltage	[V]	400	690

UL 4248

Markings			cURus
----------	--	--	-------

* If the product is used with direct current, switching under load is not permitted. In this case, the warning "do not open under load" must be visible in the front of the device.

Electrical symbols

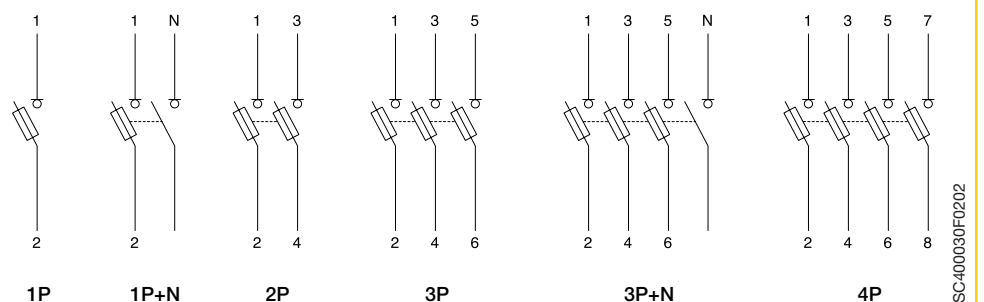

Materials

Plastic parts	Case:	Material PA 6 +30% glass fibre
		Self extinguishing class: V2 (UL94)
		Temperature resistance: 130 °C
	Opening handle	Material PA 66 +25% glass fibre
Self-extinguishing class V0 (UL94)		
Temperature resistance: 140 °C		
Metal parts	Clips	Silver plated copper
	Clip spring	Stainless steel
	Terminals	Galvanized steel

The E 90 series is environmental friendly and protects the health of people: all used materials are conform to the RoHS and REACH directives and they completely exclude hazardous substances and halogen.

5

Utilization category

Current type	Utilization category	Typical applications
Alternating current	AC-20A - AC-20B	Connecting and disconnecting under no load (in this case the devices must be marked "Do not disconnect under load")
	AC-21A - AC-21B	Switching of resistive loads, including moderate overloads
	AC-22A - AC-22B	Switching of mixed resistive/inductive loads, including moderate overloads
	AC-23A - AC-23B	Switching of motors and other highly inductive loads
Direct current	DC-20A - DC-20B	Connecting and disconnecting under no load (in this case the devices must be marked "Do not open under load")
	DC-21A - DC-21B	Switching of resistive loads, including moderate overloads
	DC-22A - DC-22B	Switching of mixed resistive / inductive loads, including moderate overloads
	DC-23A - DC-23B	Switching of motors or other highly inductive loads
	Suffix A	Frequent use
	Suffix B	Infrequent use

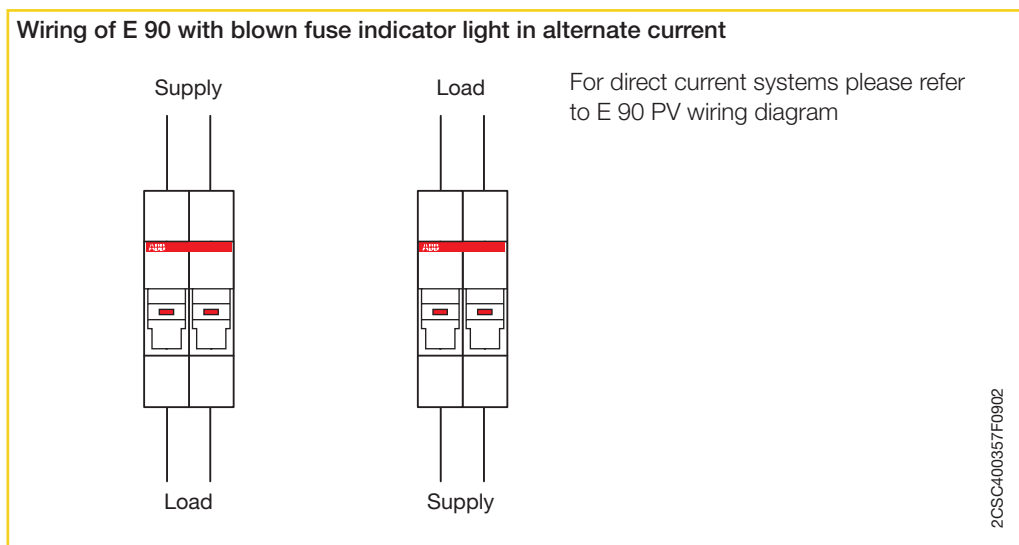



E 90h fuseholders

E 90h fuseholders are suitable for protection against overloads and short circuits. Available in a single module 1P+N version and in a three-module 3P+N version, they are designed for use with gG and aM cylindrical fuse links. The body is made from self-extinguishing material resistant to high temperatures, while the contact clips are in silver-plated copper. E 90h fuseholders can be sealed or padlocked to assure operator safety during maintenance. Versions with blown fuse indicator allow to check whether the fuse is still working correctly or not.

E 90h fuseholders for 10.3 x 38 mm fuses

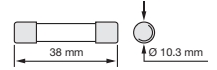

Poles	Rated current In	Modules	Order details Type code	Order code	Bbn 8012542 EAN	Price 1 piece	Price group	Weight 1 piece kg	Pack unit pc.
1+N	32	1	E 91hN/32	2CSM200913R1801	009139			0.070	6
1+N	32	1	E 91hN/32s	2CSM206573R1801	065739			0.071	6
3+N	32	3	E 93hN/32	2CSM204743R1801	047438			0.192	2

s: version with blown fuse indicator light

E 90h fuseholders for 8.5 x 31.5 mm fuses

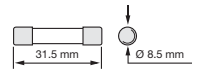

Poles	Rated current In	Modules	Order details Type code	Order code	Bbn 009634 EAN	Price 1 piece	Price group	Weight 1 piece kg	Pack unit pc.
1+N	20	1	E 91hN/20	2CSM200963R1801	009634			0.070	6
1+N	20	1	E 91hN/20s	2CSM200703R1801	007036			0.071	6
3+N	20	3	E 93hN/20	2CSM200933R1801	009337			0.192	2

s: version with blown fuse indicator light

Fuse indicator LED



2CSC400030F0202

Technical features

Type		E 90hN/20	E 90hN/32
Fuse	[mm]	8 x 31	10 x 38
Current type			a.c. / d.c.
Rated frequency	[Hz]		= / 50-60
Rated current	[A]	20	32
Max power dissipation	[W]	2.5	3
Tightening torque	[Nm]		PZ2 0.8-1.2
Terminal cross section	[mm ²]		16
Protection degree			IP20
Can be padlocked (open)		■	■
Can be sealed (closed)		■	■
IEC 60269-1			
Rated a.c. voltage	[V]	400	690
Rated d.c. voltage	[V]	400	690
IEC 60269-2			
Fuse system			F
Rated a.c. voltage	[V]	400	690
Rated d.c. voltage	[V]	250	440
Breaking capacity	[kA]	200 (a.c.) – 100 (d.c.)	
IEC 60269-3			
Fuse system			B
Rated a.c. voltage	[V]	400	690
Markings			IMQ
IEC 60269-4			
Fuse system			F
Rated a.c. voltage	[V]	400	690
Rated d.c. voltage	[V]	400	690
UL 4248			
Mark			cURus

Electrical symbols

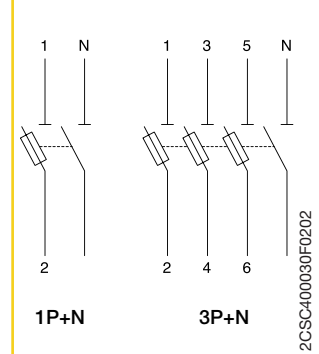

2CSC400030F0202



E 90 PV fuse disconnectors

E 90 PV series fuse disconnectors, designed for operating voltages of 1000 V d.c. with utilization category DC-20B, are particularly suited for protection against overcurrents of photovoltaic systems. The single-pole or two-pole E 90 PV disconnectors for 10.3 x 38 mm cylindrical fuse links offer a reliable, compact and affordable solution for photovoltaic installations. Versions with blown fuse indicator allow to check whether the fuse is still working correctly or not.

E 90 PV fuse disconnectors for 10.3 x 38 mm fuses (DC-20B)



Poles	Rated current In	Modules	Order details Type code	Order code	Bbn 8012542 EAN	Price 1 piece	Price group	Weight 1 piece kg	Pack unit pc.
1	32	1	E 91/32 PV	2CSM204713R1801	047131			0.061	6
1	32	1	E 91/32 PVs	2CSM204693R1801	046936			0.062	6
2	32	2	E 92/32 PV	2CSM204703R1801	047032			0.122	3
2	32	2	E 92/32 PVs	2CSM256913R1801	569138			0.233	3

s: version with blown fuse indicator light

5

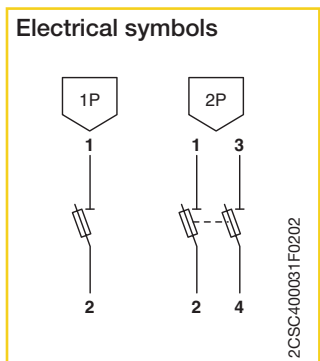

Technical features

Type	E 90/32 PV	
Fuse	[mm]	10 x 38
Current type		d.c.
Rated frequency	[Hz]	-
Rated current	[A]	32
Max power dissipation	[W]	3
Tightening torque	[Nm]	PZ2 2-2.5
Terminal cross section	[mm ²]	25
Protection degree		IP20
Can be padlocked (open)		■
Can be sealed (closed)		■
IEC 60947-3		
Rated operating voltage	[V]	1000
Utilization category		DC-20B

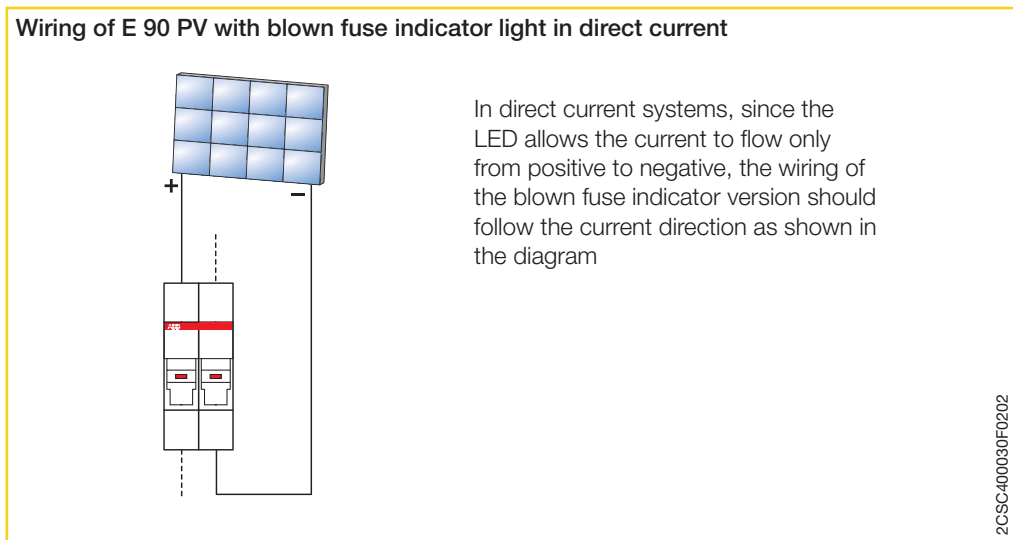

Protection and disconnection of 1000 V DC lines

String protection

To avoid equipments damage on DC lines and to ensure isolation of the PV system in case of maintenance, E90 PV disconnectors fuses can be installed downstream the inverter to protect each single string. The fuses must be selected according to the rated current of the line and to the maximum dissipated power.

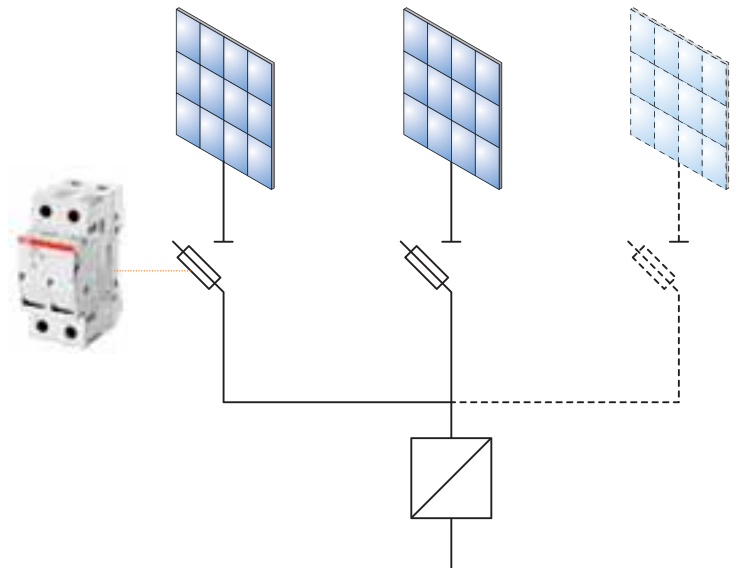

Back-Up Download

When the I_{cc} short circuit current, at the point of installation, is greater than 100 A DC, the OVR PVs Surge Protective Devices require a back-up protection with a specific type gR fuse.

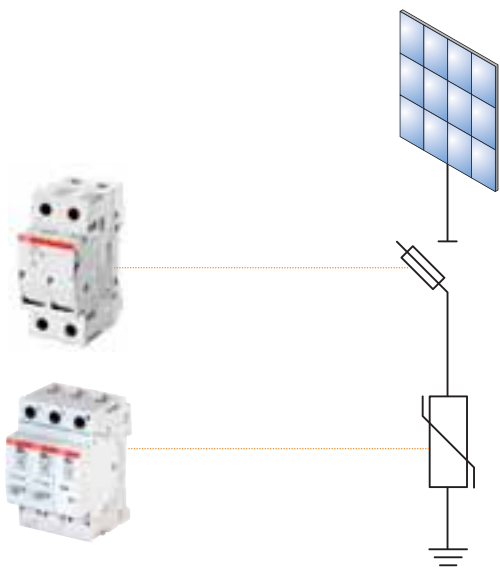

DC side of the inverter

For small size photovoltaic systems, E 90 PV fuse disconnectors can be used to protect the DC side of the inverter. The fuse should be chosen according to the rated current of the inverter.

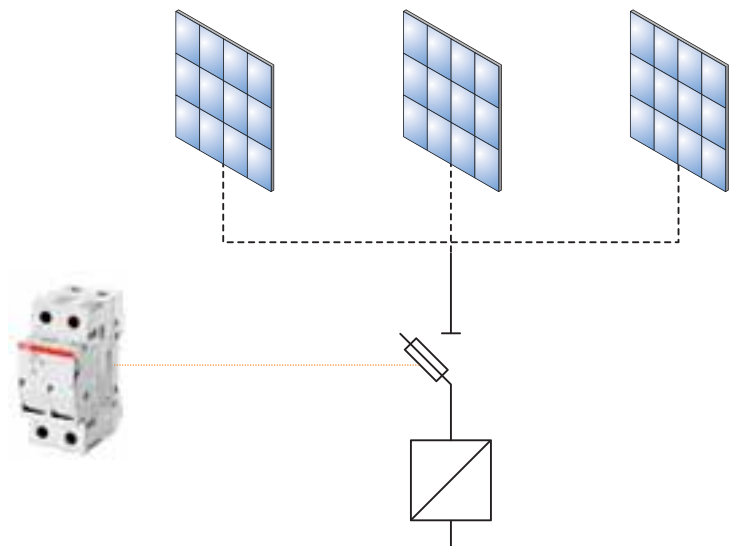

2CSC400032F0202



The E 90 fuse carriers for Class CC cylindrical fuse links are specifically designed for the North American market in compliance with the UL standards. In accordance with the reference standards UL 4248-1 and UL 4248-4, they come in voltage and current ratings up to 600V and 30A. They are available in 1P, 1P+N, 2P, 3P, 3P+N and 4P versions. They can be padlocked open and sealed closed.

The E 90 fuse carriers are the ideal solution for process control and industrial systems, automation systems, industrial installations and control circuits. The versions with blown fuse indicator light provide a visual signal of the fuse break condition

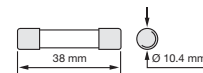

E 90 for class CC cartridge fuses

Poles	Rated current In	Modules	Order details Type code	Order code	Bbn 8012542 EAN	Price 1 piece	Price group	Weight 1 piece kg	Pack unit pc.
1	30	1	E 91/30	2CSM205833R1801	058335			0,061	6
1	30	1	E 91/30s	2CSM251533R1801	515333			0,062	6
1+N	30	2	E 91N/30	2CSM200693R1801	006930			0,13	3
2	30	2	E 92/30	2CSM202443R1801	024439			0,122	3
3	30	3	E 93/30	2CSM200683R1801	006831			0,183	2
3+N	30	4	E 93N/30	2CSM202433R1801	024330			0,252	1
4	30	4	E 94/30	2CSM200673R1801	006732			0,244	1

s: version with blown fuse indicator light

5

Technical features

			30A
Rated voltage Un	[V]		600 a.c. /d.c.
Rated current In	[A]		30
Rated frequency	[Hz]		=/50-60
Fuse size	[mm]		10.4 x 38.1
Tightening torque	[Nm]		PZ2 2-2.5
Rated temperature	[°C]		75
Can be sealed closed			■
Can be padlocked open			■
Markings			UL CSA
Standards			UL 4248-1 (General) UL 4248-4 (Class CC)

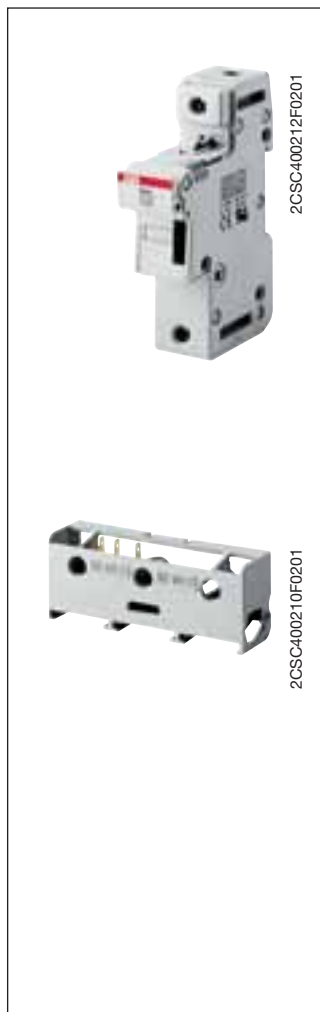

E 930 fuse disconnectors

The E 930 fuse disconnector range, for current of 50 A and 125 A, is specifically intended for industrial circuit protection. The E 930 can carry any type of cylindrical fuses 14x51 and 22x58 mm, they are padlockable in open position to ensure operator safety during maintenance operations. The E 930 also support MCR microswitches, through which you can get a complete remote monitoring of the device state. The microswitch makes it possible to report: the fuse intervention, the opening of the drawer and the fuse absence with closed drawer.

E 930 fuse disconnectors for 14 x 51 mm fuses (AC-20B)

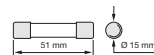

Poles	Rated current In	Modules	Order details Type code	Order code	Bbn 8012542 EAN	Price 1 piece	Price group	Weight 1 piece kg	Pack unit pc.
1	50	1.5	E 931/50	2CSM361610R1801	446804			0.200	6
1+N	50	3	E 931N/50	2CSM365610R1801	446903			0.400	3
2	50	3	E 932/50	2CSM362610R1801	447009			0.400	3
3	50	4.5	E 933/50	2CSM363610R1801	447108			0.600	1
3+N	50	6	E 933N/50	2CSM367610R1801	447207			0.800	1

E 930 fuse disconnectors for 22 x 58 mm fuses (AC-20B)



1	125	2	E 931/125	2CSM371710R1801	447504			0.200	6
1+N	125	4	E 931N/125	2CSM375710R1801	447603			0.400	3
2	125	4	E 932/125	2CSM372710R1801	447702			0.400	3
3	125	6	E 933/125	2CSM373710R1801	447801			0.600	1
3+N	125	8	E 933N/125	2CSM377710R1801	447900			0.800	1

Microswitches for series E 930 fuse disconnectors

1	50	1	E 930/MCR1P50	2CSM060019R1801	451006			0.030	1
3	50	3	E 930/MCR3P50	2CSM060029R1801	451105			0.030	1
1	125	1	E 930/MCR1P125	2CSM070019R1801	451204			0.030	1
3	125	3	E 930/MCR3P125	2CSM070029R1801	451303			0.030	1

Technical features

		50 A	125 A
Rated voltage Un	[V]		750 a.c./d.c.
Insulation voltage	[V]		8000
Rated current In	[A]	50	125
Short circuit current Icc	[A]		see fuse link
Rated frequency	[Hz]		50-60
Fuse size	[mm]	14 x 51	22 x 58
Utilization category			AC-20B/DC-20B
Max power dissipation	[W]	5	9.5
Terminals	[mm ²]	25	35
Can be sealed closed			■
Can be padlocked open			■
Protection degree			IP20
Markings			UL, CSA
Standards			IEC 60947-3

Electrical symbols

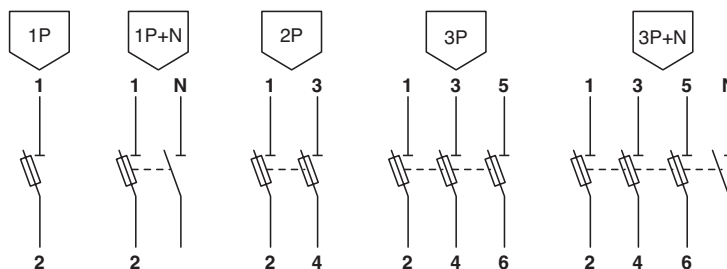

2CSC400031F0202

Padlocked in open position

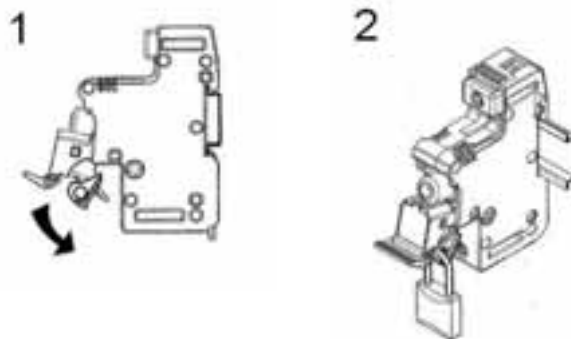

2CSC400033F0202

State of the E 930/MCR microswitch contact

Closed fuseholders with fuse

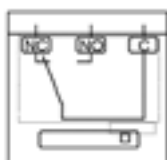

Open fuseholders without fuse

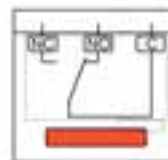

2CSC400034F0202

Microswitch functions

a - fuse blown : indicates fuse break condition

b - pre-opening: indicates when the fuseholders cover is open

c - presence: indicates when the cover is closed but there is no fuse

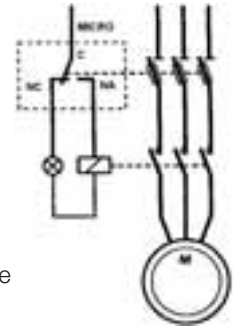

2CSC400036F0202

Microswitch assembly and disassembly steps

1- assembly

2- disassembly

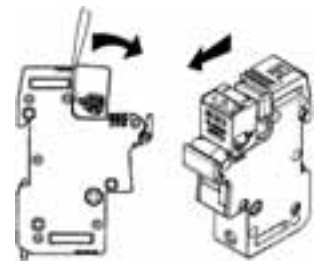
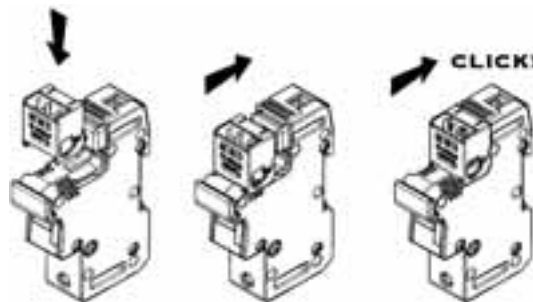

2CSC400036F0202

Protection system selection

Maximum fuse rated current

		Fuseholder			
		E 90/20 8.5 x 31.5 mm	E 90/32 10.3 x 38 mm	E 930/50 14 x 51 mm	E 930/125 22 x 58 mm
400 V a.c.	gG	20 A	32 A	50 A	125 A
	aM	10 A	32 A	50 A	125 A
500 V a.c.	gG	-	25 A	40 A	100 A
	aM	-	25 A	40 A	100 A
690 V a.c.	gG	-	10 A	25 A	80 A
	aM	-	-	25 A	80 A

In the table above you will find indication about the highest rated current fuse that you can host inside a fuseholder, depending on the rated voltage of the circuit, the fuse size and the tripping curve characteristic.

ABB fuses and fuseholders comply with all regulatory requirements and sometimes they allow to install a fuse with rated current higher than the one set by the Standard IEC EN 60269-2-1.

Multiple poles pole installation

E 91/32		E 91hN/32	
Poles	Maximum current	Poles	Maximum current
1...4	I_n	1...3	I_n
5...7	$0.8 \times I_n$	4...9	$0.7 \times I_n$
more than	$0.7 \times I_n$	more than 10	$0.6 \times I_n$

Climate conditions

Maximum temperature	20 °C	30 °C	40 °C	50 °C
Maximum humidity	95%	90%	80%	50%
Maximum current	I_n	$I_n \times 0.95$	$I_n \times 0.9$	$I_n \times 0.8$

In case of several paired poles or installation in special climate conditions, take into account the derating parameters listed in the table according to rated current, the number of paired poles or temperature and relative humidity.

E 9F gG cylindrical fuses

The E 9F gG cylindrical fuses, coupled with E 90 and E 930 fuse disconnectors, are the ideal solution for protection against overload and short-circuit. They feature a fast tripping curve that is ideal for protecting electronic devices, transformers and electric cables. The E 9F gG series is available for all the main sizes (8.5 x 31.5 mm, 10.3 x 38 mm, 14 x 51 mm e 22 x 58 mm) and with a wide range of rated current values (from 1 A to 125 A and up to 690 V a.c.). All the E 9F series fuses conform to the RoHS directive and are type-approved in accordance with the most important international naval marks.

E 9F 8 gG cylindrical fuses 8.5 x 31.5 mm

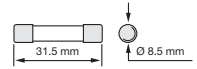

Rated current In	Size mm	Order details Type code	Order code	Bbn 8012542 EAN	Price 1 piece	Price group	Weight 1 piece kg	Pack unit pc.
1	8.5x31.5	E 9F8 GG1	2CSM257573R1801	575733			0.004	10
2	8.5x31.5	E 9F8 GG2	2CSM256393R1801	563938			0.004	10
4	8.5x31.5	E 9F8 GG4	2CSM258663R1801	586630			0.004	10
6	8.5x31.5	E 9F8 GG6	2CSM257483R1801	574835			0.004	10
8	8.5x31.5	E 9F8 GG8	2CSM256303R1801	563037			0.004	10
10	8.5x31.5	E 9F8 GG10	2CSM277573R1801	775737			0.004	10
12	8.5x31.5	E 9F8 GG12	2CSM277353R1801	773535			0.004	10
16	8.5x31.5	E 9F8 GG16	2CSM277133R1801	771333			0.004	10
20	8.5x31.5	E 9F8 GG20	2CSM277503R1801	775034			0.004	10

E 9F 10 gG cylindrical fuses 10.3 x 38 mm

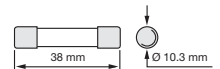

Rated current In	Size mm	Order details Type code	Order code	Bbn 8012542 EAN	Price 1 piece	Price group	Weight 1 piece kg	Pack unit pc.
0.5	10.3x38	E 9F10 GG05	2CSM277333R1801	773337			0.007	10
1	10.3x38	E 9F10 GG1	2CSM277113R1801	771135			0.007	10
2	10.3x38	E 9F10 GG2	2CSM258723R1801	587231			0.007	10
4	10.3x38	E 9F10 GG4	2CSM257543R1801	575436			0.007	10
6	10.3x38	E 9F10 GG6	2CSM256363R1801	563631			0.007	10
8	10.3x38	E 9F10 GG8	2CSM258633R1801	586333			0.007	10
10	10.3x38	E 9F10 GG10	2CSM257453R1801	574538			0.007	10
12	10.3x38	E 9F10 GG12	2CSM256273R1801	562733			0.007	10
16	10.3x38	E 9F10 GG16	2CSM277543R1801	775430			0.007	10
20	10.3x38	E 9F10 GG20	2CSM277323R1801	773238			0.007	10
25	10.3x38	E 9F10 GG25	2CSM277103R1801	771036			0.007	10
32	10.3x38	E 9F10 GG32	2CSM258713R1801	587132			0.007	10

E 9F 14 gG cylindrical fuses 14 x 51 mm

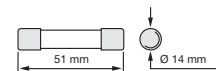

Rated current In	Size mm	Order details Type code	Order code	Bbn 8012542 EAN	Price 1 piece	Price group	Weight 1 piece kg	Pack unit pc.
2	14x51	E 9F14 GG2	2CSM277523R1801	775232			0.018	10
4	14x51	E 9F14 GG4	2CSM277303R1801	773030			0.018	10
6	14x51	E 9F14 GG6	2CSM277083R1801	770831			0.018	10
8	14x51	E 9F14 GG8	2CSM291003R1801	910039			0.018	10
10	14x51	E 9F14 GG10	2CSM290983R1801	909835			0.018	10
12	14x51	E 9F14 GG12	2CSM290963R1801	909637			0.018	10
16	14x51	E 9F14 GG16	2CSM258783R1801	587835			0.018	10
20	14x51	E 9F14 GG20	2CSM257603R1801	576037			0.018	10
25	14x51	E 9F14 GG25	2CSM256423R1801	564232			0.018	10
32	14x51	E 9F14 GG32	2CSM258693R1801	586937			0.018	10
40	14x51	E 9F14 GG40	2CSM257513R1801	575139			0.018	10
50	14x51	E 9F14 GG50	2CSM256333R1801	563334			0.018	10



2CSC400037F0202



2CSC400038F0202



2CSC400039F0202

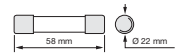

E 9F 22 gG cylindrical fuses 22 x 58 mm

Rated current	Size	Order details	Bbn	Price	Price	Weight	Pack
In	mm	Type code	Order code	8012542	1 piece	group	1 piece
			EAN			kg	pc.
4	22x58	E 9F22 GG4	2CSM257183R1801	571834		0.048	10
6	22x58	E 9F22 GG6	2CSM259283R1801	592839		0.048	10
8	22x58	E 9F22 GG8	2CSM258103R1801	581031		0.048	10
10	22x58	E 9F22 GG10	2CSM256923R1801	569237		0.048	10
12	22x58	E 9F22 GG12	2CSM259403R1801	594031		0.048	10
16	22x58	E 9F22 GG16	2CSM258223R1801	582236		0.048	10
20	22x58	E 9F22 GG20	2CSM257043R1801	570431		0.048	10
25	22x58	E 9F22 GG25	2CSM259533R1801	595335		0.048	10
32	22x58	E 9F22 GG32	2CSM258353R1801	583530		0.048	10
40	22x58	E 9F22 GG40	2CSM257173R1801	571735		0.048	10
50	22x58	E 9F22 GG50	2CSM259393R1801	593935		0.048	10
63	22x58	E 9F22 GG63	2CSM258213R1801	582137		0.048	10
80	22x58	E 9F22 GG80	2CSM257033R1801	570332		0.048	10
100	22x58	E 9F22 GG100	2CSM259523R1801	595236		0.048	10
125	22x58	E 9F22 GG125	2CSM258343R1801	583431		0.048	10

Technical features

Rated voltage	[V]	400, 500, 690 AC
Rated current	[A]	0,5...125
Breaking capacity	[kA]	20, 80, 120
Overall dimensions	[mm]	8.5x31.5, 10.3x38, 14x51, 22x58
Weight	[g]	4, 7, 18, 48
Standards		IEC 60269-2; ROHS 2002/98/CE
Marks		LLOYD, NF, BV

E 9F 8 gG cylindrical fuses 8.5 x 31.5 mm

Type	Rated current [A]	Rated voltage [V AC]	Breaking capacity [kA]
E 9F8 GG1	1	400	20
E 9F8 GG2	2	400	20
E 9F8 GG4	4	400	20
E 9F8 GG6	6	400	20
E 9F8 GG8	8	400	20
E 9F8 GG10	10	400	20
E 9F8 GG12	12	400	20
E 9F8 GG16	16	400	20
E 9F8 GG20	20	400	20

E 9F 10 gG cylindrical fuses 10.3 x 38 mm

Type	Rated current [A]	Rated voltage [V AC]	Breaking capacity [kA]
E 9F10 GG05	0.5	500	120
E 9F10 GG1	1	500	120
E 9F10 GG2	2	500	120
E 9F10 GG4	4	500	120
E 9F10 GG6	6	500	120
E 9F10 GG8	8	500	120
E 9F10 GG10	10	500	120
E 9F10 GG12	12	500	120
E 9F10 GG16	16	500	120
E 9F10 GG20	20	500	120
E 9F10 GG25	25	500	120
E 9F10 GG32	32	400	120

E 9F 14 gG cylindrical fuses 14 x 51 mm

Type	Rated current [A]	Rated voltage [V AC]	Breaking capacity [kA]
E 9F14 GG2	2	690	80
E 9F14 GG4	4	690	80
E 9F14 GG6	6	690	80
E 9F14 GG8	8	690	80
E 9F14 GG10	10	690	80
E 9F14 GG12	12	690	80
E 9F14 GG16	16	690	80
E 9F14 GG20	20	690	80
E 9F14 GG25	25	690	80
E 9F14 GG32	32	500	120
E 9F14 GG40	40	500	120
E 9F14 GG50	50	400	120

E 9F 22 gG cylindrical fuses 22 x 58 mm

Type	Rated current [A]	Rated voltage [V AC]	Breaking capacity [kA]
E 9F22 GG4	4	690	80
E 9F22 GG6	6	690	80
E 9F22 GG8	8	690	80
E 9F22 GG10	10	690	80
E 9F22 GG12	12	690	80
E 9F22 GG16	16	690	80
E 9F22 GG20	20	690	80
E 9F22 GG25	25	690	80
E 9F22 GG32	32	690	80
E 9F22 GG40	40	690	80
E 9F22 GG50	50	690	80
E 9F22 GG63	63	690	80
E 9F22 GG80	80	690	80
E 9F22 GG100	100	500	120
E 9F22 GG125	125	400	120

Power dissipation [W]

In [A]	Size		
	10.3x38	14x51	22x58
0.5	2		
1	2.5	3.4	
2	0.70	1	1.20
4	0.80	1.10	1.30
6	0.90	1.20	1.40
8	1.10	1.50	1.65
10	1.35	1.80	2
12	1.55	2.10	2.40
16	1.90	2.55	3
20	2.30	3	3.40
25	2.80	3.50	3.80
32	3	3.80	4.30
40		4.40	5.10
50		4.70	5.50
63			6.70
80			8
100			9
125			12.5

It is important verify that the power dissipation by the fuse does not exceed the limit allowed by the fuse it is hosted. In blue are shown the maximum values of power dissipation according with the range E 90 and E 930 specifications.

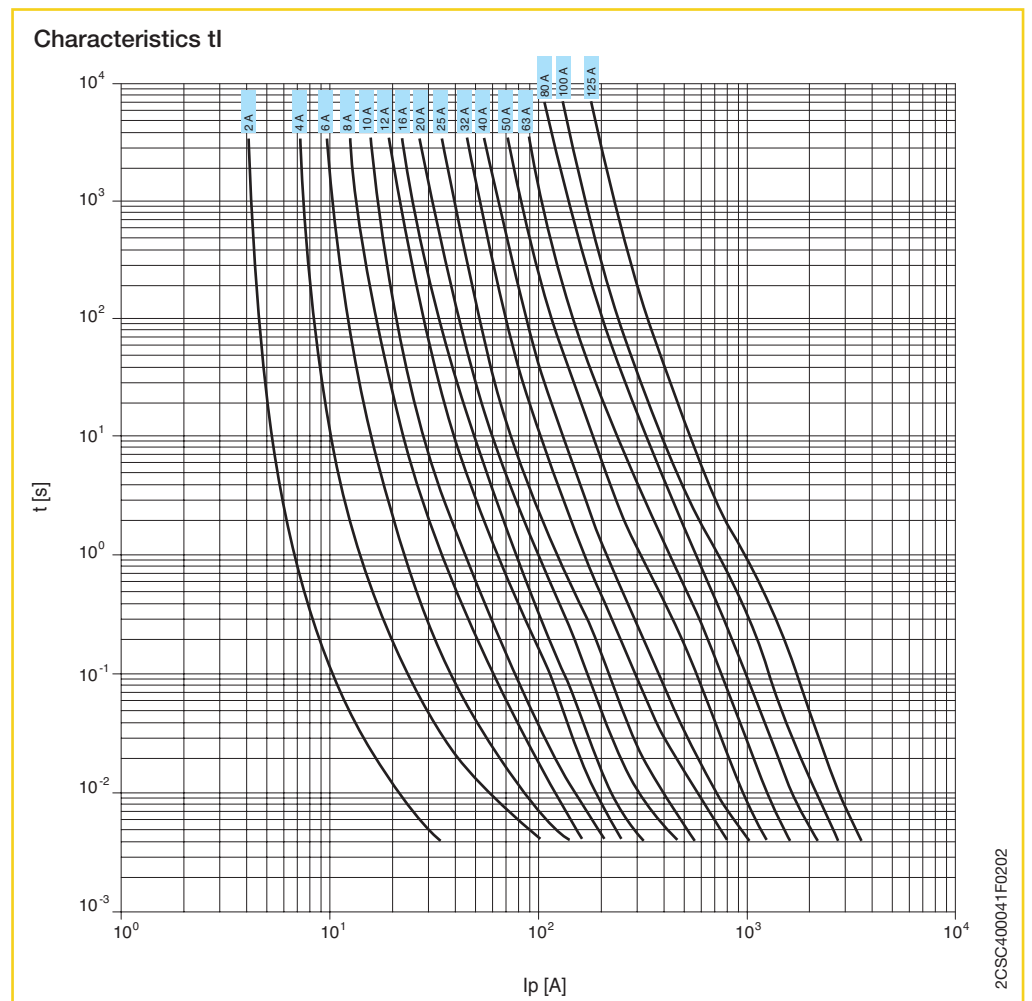

5

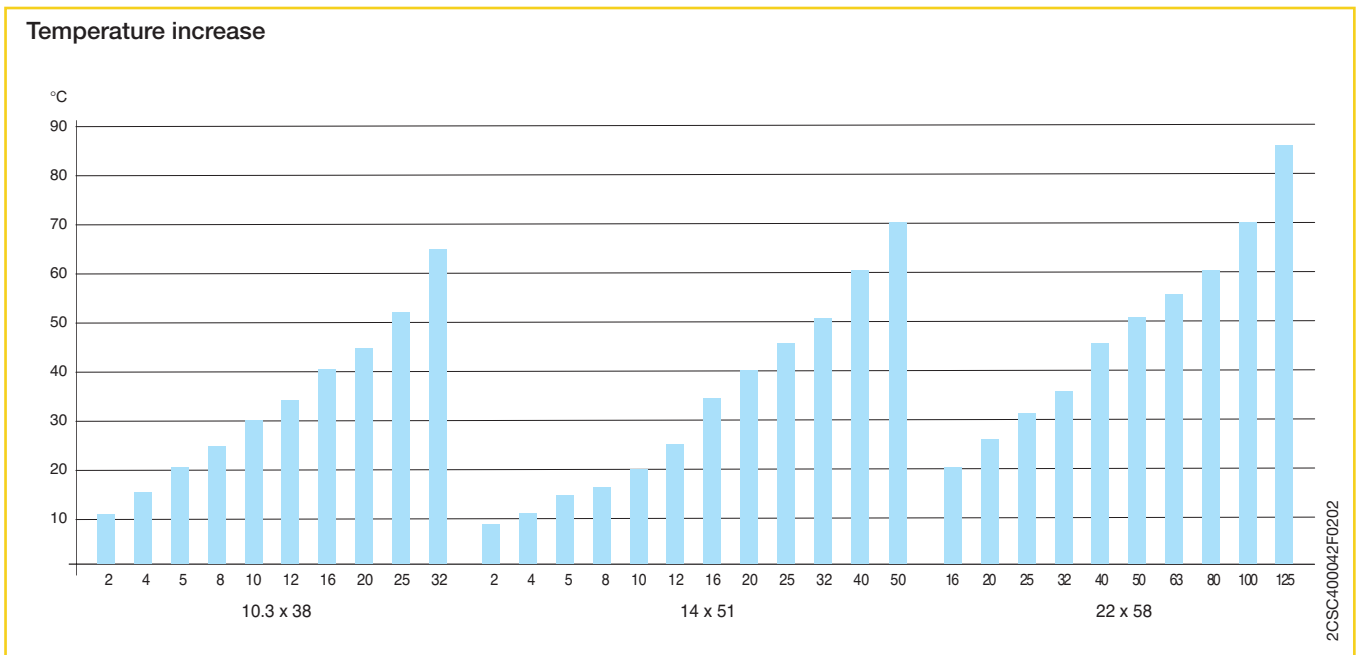
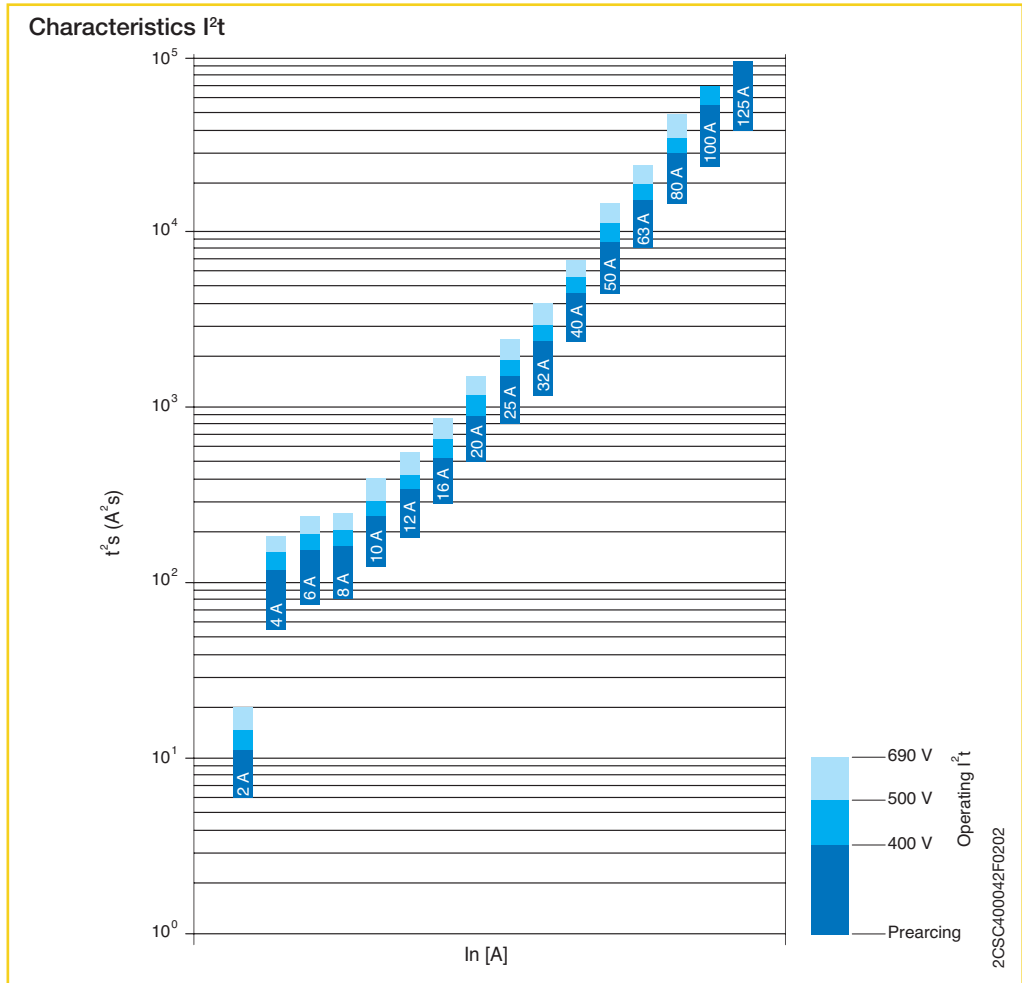

E 9F aM cylindrical fuses

The E 9F aM cylindrical fuses, coupled with E 90 and E 930 fuse disconnectors, are the ideal solution for protection against overload and short-circuit. They feature a delayed tripping curve and are therefore ideal for protecting industrial motors that require high inrush current during the starting phase. The E 9F aM series is available for all the main sizes (8.5 x 31.5 mm, 10.3 x 38 mm, 14 x 51 mm e 22 x 58 mm) and with a wide range of rated current values (from 1 A to 125 A and up to 690 V a.c.). All the E 9F series fuses conform to the RoHS directive and are type-approved in accordance with the most important international naval marks.

E 9F 8 aM cylindrical fuses 8.5 x 31.5 mm

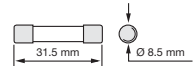

Rated current In	Size mm	Order details Type code	Order code	Bbn 8012542 EAN	Price 1 piece	Price group	Weight 1 piece kg	Pack unit pc.
1	8.5x31.5	E 9F8 AM1	2CSM277283R1801	772835			0.004	10
2	8.5x31.5	E 9F8 AM2	2CSM277063R1801	770633			0.004	10
4	8.5x31.5	E 9F8 AM4	2CSM258743R1801	587439			0.004	10
6	8.5x31.5	E 9F8 AM6	2CSM257563R1801	575634			0.004	10
8	8.5x31.5	E 9F8 AM8	2CSM256383R1801	563839			0.004	10
10	8.5x31.5	E 9F8 AM10	2CSM258653R1801	586531			0.004	10

E 9F 10 aM cylindrical fuses 10.3 x 38 mm

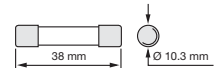

Rated current In	Size mm	Order details Type code	Order code	Bbn 8012542 EAN	Price 1 piece	Price group	Weight 1 piece kg	Pack unit pc.
0.5	10.3x38	E 9F10 AM05	2CSM257473R1801	574736			0.007	10
1	10.3x38	E 9F10 AM1	2CSM256293R1801	562931			0.007	10
2	10.3x38	E 9F10 AM2	2CSM277563R1801	775638			0.007	10
4	10.3x38	E 9F10 AM4	2CSM277343R1801	773436			0.007	10
6	10.3x38	E 9F10 AM6	2CSM277123R1801	771234			0.007	10
8	10.3x38	E 9F10 AM8	2CSM258733R1801	587330			0.007	10
10	10.3x38	E 9F10 AM10	2CSM257553R1801	575535			0.007	10
12	10.3x38	E 9F10 AM12	2CSM256373R1801	563730			0.007	10
16	10.3x38	E 9F10 AM16	2CSM258643R1801	586432			0.007	10
20	10.3x38	E 9F10 AM20	2CSM257463R1801	574637			0.007	10
25	10.3x38	E 9F10 AM25	2CSM256283R1801	562832			0.007	10
32	10.3x38	E 9F10 AM32	2CSM277553R1801	775539			0.007	10

E 9F 14 aM cylindrical fuses 14 x 51 mm



Rated current In	Size mm	Order details Type code	Order code	Bbn 8012542 EAN	Price 1 piece	Price group	Weight 1 piece kg	Pack unit pc.
1	14x51	E 9F14 AM1	2CSM257533R1801	575337			0.018	10
2	14x51	E 9F14 AM2	2CSM256353R1801	563532			0.018	10
4	14x51	E 9F14 AM4	2CSM258623R1801	586234			0.018	10
6	14x51	E 9F14 AM6	2CSM257443R1801	574439			0.018	10
8	14x51	E 9F14 AM8	2CSM256263R1801	562634			0.018	10
10	14x51	E 9F14 AM10	2CSM277533R1801	775331			0.018	10
12	14x51	E 9F14 AM12	2CSM277313R1801	773139			0.018	10
16	14x51	E 9F14 AM16	2CSM277093R1801	770930			0.018	10
20	14x51	E 9F14 AM20	2CSM258703R1801	587033			0.018	10
25	14x51	E 9F14 AM25	2CSM257523R1801	575238			0.018	10
32	14x51	E 9F14 AM32	2CSM256343R1801	563433			0.018	10
40	14x51	E 9F14 AM40	2CSM258613R1801	586135			0.018	10
45	14x51	E 9F14 AM45	2CSM257433R1801	574330			0.018	10
50	14x51	E 9F14 AM50	2CSM256253R1801	562535			0.018	10



2CSC400037F0202



2CSC400038F0202



2CSC400039F0202

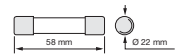

E 9F 22 aM cylindrical fuses 22 x 58 mm

Rated current In	Size mm	Order details Type code	Order code	Bbn 8012542 EAN	Price 1 piece	Price group	Weight 1 piece kg	Pack unit pc.
6	22x58	E 9F22 AM6	2CSM258603R1801	586036			0.048	10
8	22x58	E 9F22 AM8	2CSM257423R1801	574231			0.048	10
10	22x58	E 9F22 AM10	2CSM256243R1801	562436			0.048	10
12	22x58	E 9F22 AM12	2CSM277513R1801	775133			0.048	10
16	22x58	E 9F22 AM16	2CSM277293R1801	772934			0.048	10
20	22x58	E 9F22 AM20	2CSM277073R1801	770732			0.048	10
25	22x58	E 9F22 AM25	2CSM277493R1801	774938			0.048	10
32	22x58	E 9F22 AM32	2CSM277273R1801	772736			0.048	10
40	22x58	E 9F22 AM40	2CSM277053R1801	770534			0.048	10
50	22x58	E 9F22 AM50	2CSM259413R1801	594130			0.048	10
63	22x58	E 9F22 AM63	2CSM258233R1801	582335			0.048	10
80	22x58	E 9F22 AM80	2CSM257053R1801	570530			0.048	10
100	22x58	E 9F22 AM100	2CSM259543R1801	595434			0.048	10
125	22x58	E 9F22 AM125	2CSM258363R1801	583639			0.048	10

5

Technical features

Rated voltage	[V]	400, 500, 690 AC
Rated current	[A]	0,5...125
Breaking capacity	[kA]	20, 80, 120
Overall dimensions	[mm]	8.5x31.5, 10.3x38, 14x51, 22x58
Weight	[g]	4, 7, 18, 48
Standards		IEC 60269-2; ROHS 2002/98/CE
Marks		LLOYD, NF, BV

E 9F8 aM cylindrical fuses 8.5 x 31.5 mm

Type	Rated current [A]	Rated voltage [V AC]	Breaking capacity [kA]
E 9F1 AM1	1	400	20
E 9F8 AM2	2	400	20
E 9F8 AM4	4	400	20
E 9F8 AM6	6	400	20
E 9F8 AM8	8	400	20
E 9F8 AM10	10	400	20

E 9F10 aM cylindrical fuses 10.3 x 38 mm

Type	Rated current [A]	Rated voltage [V AC]	Breaking capacity [kA]
E 9F10 AM05	0.5	500	120
E 9F10 AM1	1	500	120
E 9F10 AM2	2	500	120
E 9F10 AM4	4	500	120
E 9F10 AM6	6	500	120
E 9F10 AM8	8	500	120
E 9F10 AM10	10	500	120
E 9F10 AM12	12	500	120
E 9F10 AM16	16	500	120
E 9F10 AM20	20	500	120
E 9F10 AM25	25	400	120
E 9F10 AM32	32	400	120

E 9F14 aM cylindrical fuses 14 x 51 mm

Type	Rated current [A]	Rated voltage [V AC]	Breaking capacity [kA]
E 9F14 AM1	1	690	80
E 9F14 AM2	2	690	80
E 9F14 AM4	4	690	80
E 9F14 AM6	6	690	80
E 9F14 AM8	8	690	80
E 9F14 AM10	10	690	80
E 9F14 AM12	12	690	80
E 9F14 AM16	16	690	80
E 9F14 AM20	20	690	80
E 9F14 AM25	25	690	80
E 9F14 AM32	32	500	120
E 9F14 AM40	40	500	120
E 9F14 AM45	45	500	120
E 9F14 AM50	50	400	120

E 9F22 aM cylindrical fuses 22 x 58 mm

Type	Rated current [A]	Rated voltage [V AC]	Breaking capacity [kA]
E 9F22 AM6	6	690	80
E 9F22 AM8	8	690	80
E 9F22 AM10	10	690	80
E 9F22 AM12	12	690	80
E 9F22 AM16	16	690	80
E 9F22 AM20	20	690	80
E 9F22 AM25	25	690	80
E 9F22 AM32	32	690	80
E 9F22 AM40	40	690	80
E 9F22 AM50	50	690	80
E 9F22 AM63	63	690	80
E 9F22 AM80	80	690	80
E 9F22 AM100	100	500	120
E 9F22 AM125	125	400	120

Power dissipation [W]

In [A]	Size		
	10.3x38	14x51	22x58
0.5	0.50	0.75	
1	0.13	0.18	0.20
2	0.20	0.25	0.30
4	0.30	0.40	0.50
6	0.45	0.55	0.65
8	0.55	0.65	0.75
10	0.65	0.75	0.85
12	0.75	0.85	1
16	0.90	1.20	1.40
20	1.10	1.50	1.70
25	1.40	1.80	2
32	2	2.10	2.60
40		2.60	3.20
45		2.80	
50		2.90	3.90
63			4.60
80			5.60
100			6.50
125			9.50

5

It is important verify that the power dissipation by the fuse does not exceed the limit allowed by the fuse it is hosted. In blue are shown the maximum values of power dissipation according with the range E 90 and E 930 specifications.

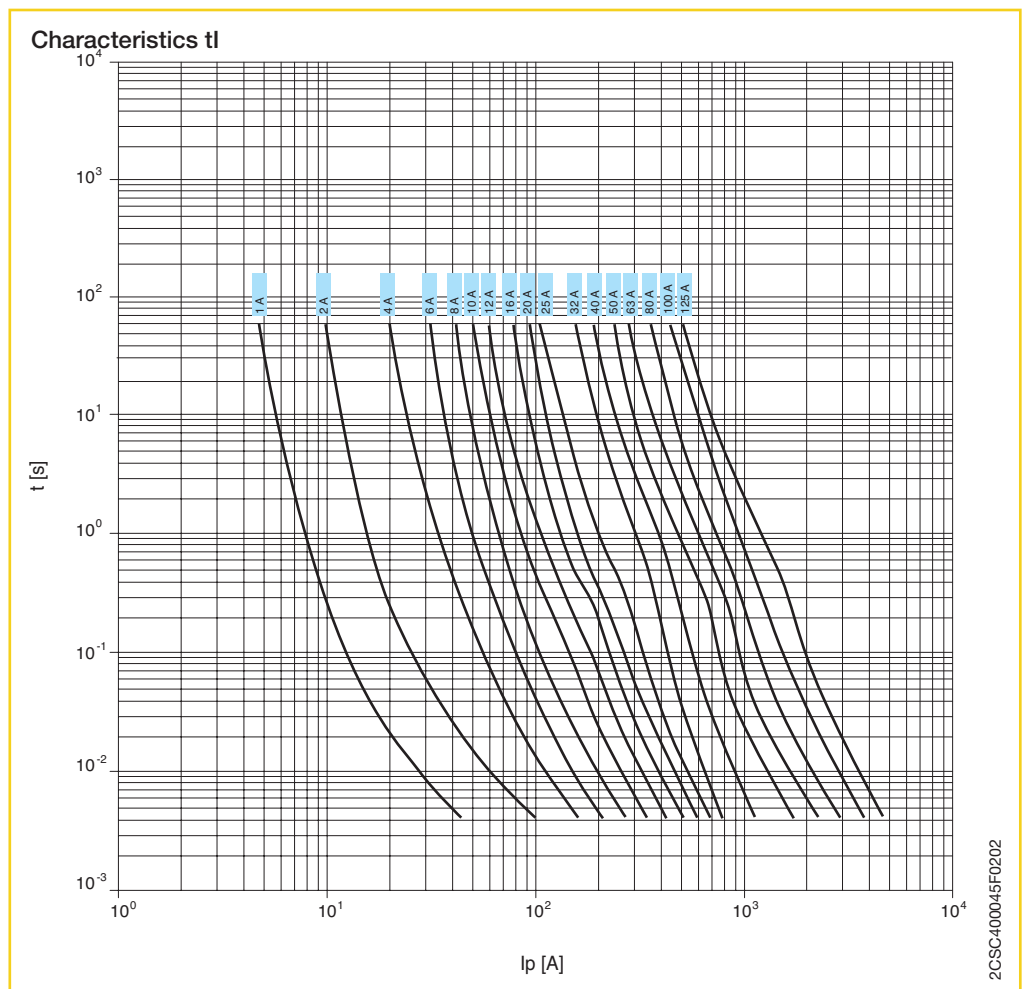

2CSC400045F0202

5

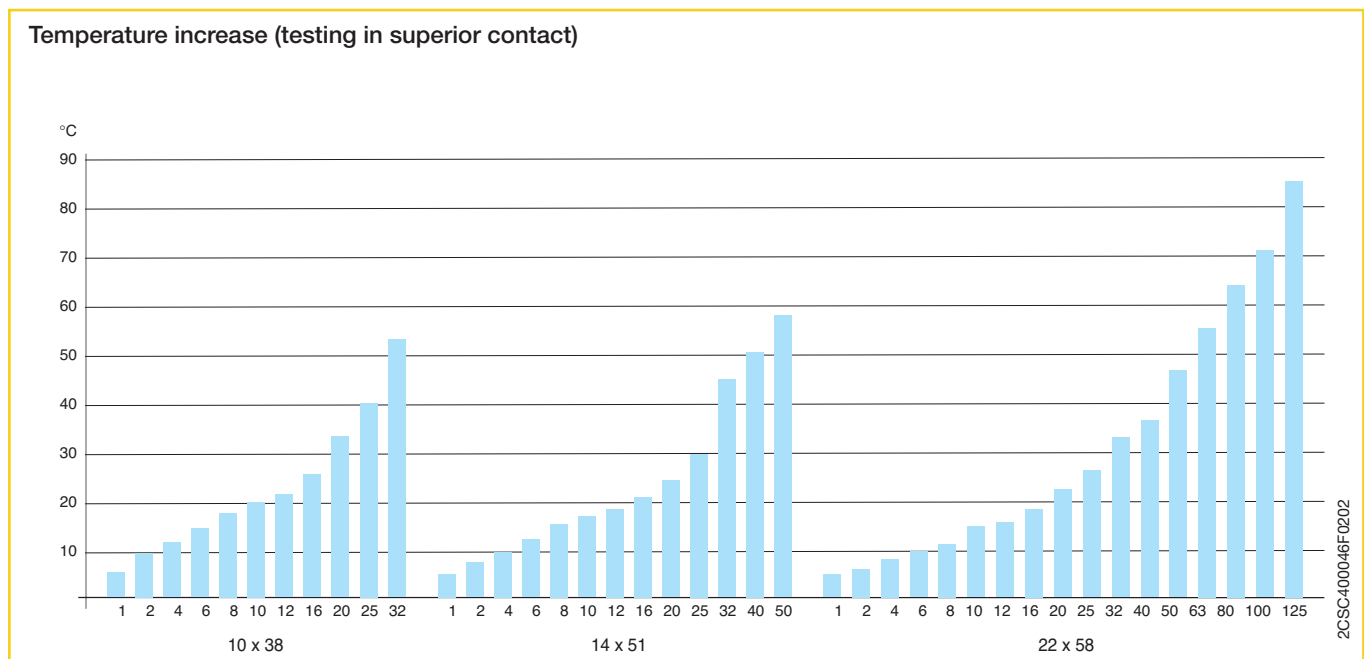
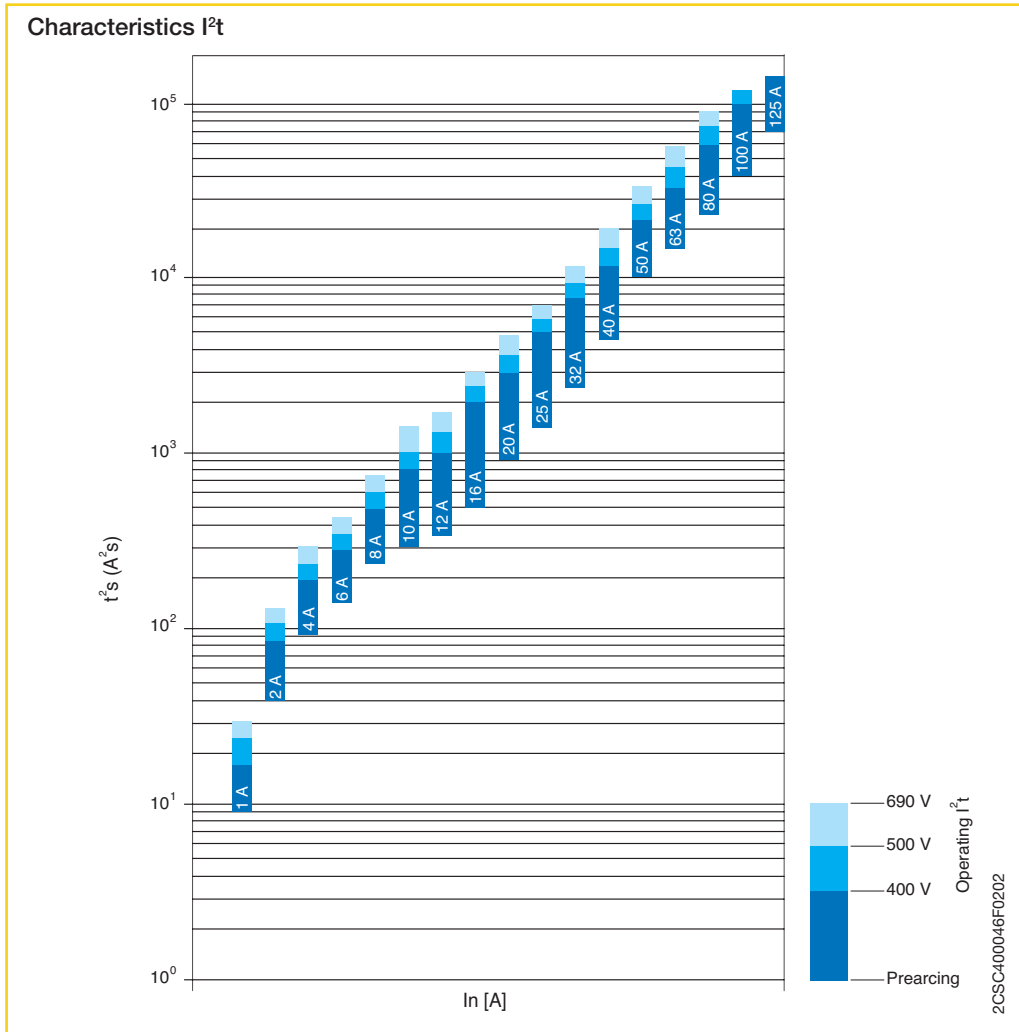



E 9F PV cylindrical fuses for photovoltaic applications

The cylindrical fuses E 9F PV series are specifically used in overcurrent protection of photovoltaic applications up to 1000 V in direct current. Thanks to the wide current range from 1 A to 30 A, and to the high nominal voltage of 1000 V DC, the series E 9F PV is ideal to protect strings, inverters and OVR surge protections according to IEC 60269-6 "Supplementary requirements for fuse-links for the protection of solar photovoltaic energy systems".

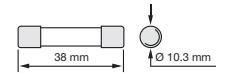

E 9F PV cylindrical fuses 10.3 x 38 mm

Rated current In	Order details Type code	Order code	Bbn 8012542 EAN	Price 1 piece	Price group	Weight 1 piece kg	Pack unit pc.
1 A	E 9F1 PV	2CSM213455R1801	134558			0.007	10
2 A	E 9F2 PV	2CSM213465R1801	134657			0.007	10
3 A	E 9F3 PV	2CSM213475R1801	134756			0.007	10
4 A	E 9F4 PV	2CSM213485R1801	134855			0.007	10
5 A	E 9F5 PV	2CSM213495R1801	134954			0.007	10
6 A	E 9F6 PV	2CSM213505R1801	135050			0.007	10
7 A	E 9F7 PV	2CSM213515R1801	135159			0.007	10
8 A	E 9F8 PV	2CSM213525R1801	135258			0.007	10
10 A	E 9F10 PV	2CSM213535R1801	135357			0.007	10
12 A	E 9F12 PV	2CSM213545R1801	135456			0.007	10
15 A	E 9F15 PV	2CSM213555R1801	135555			0.007	10
20 A	E 9F20 PV	2CSM213565R1801	135654			0.007	10
25 A	E 9F25 PV	2CSM213575R1801	135753			0.007	10
30 A	E 9F30 PV	2CSM213585R1801	135852			0.007	10

Technical features

Rated voltage	[V]	1000 DC
Rated current	[A]	1...30
Breaking capacity	[kA]	50
Minimum breaking capacity		From 1 A up to 7 A = 1.3 x In From 8 A up to 30 A = 2.0 x In
Overall dimensions	[mm]	10.3 x 38
Weight	[g]	7
Standards		IEC 60269-6; ROHS 2002/98/CE

Type	I ² t curve [A ² s]	Power consumption [W]
E 9F1 PV	-	0.32
E 9F2 PV	-	0.43
E 9F3 PV	-	1.4
E 9F4 PV	-	1.3
E 9F5 PV	-	1.4
E 9F6 PV	-	1.5
E 9F7 PV	-	1.5
E 9F8 PV	83	1.1
E 9F10 PV	127	1.5
E 9F12 PV	215	2.0
E 9F15 PV	495	3.0
E 9F20 PV	755	4.4
E 9F25 PV	970	5.3
E 9F30 PV	1650	5.8

Melting time - Current data

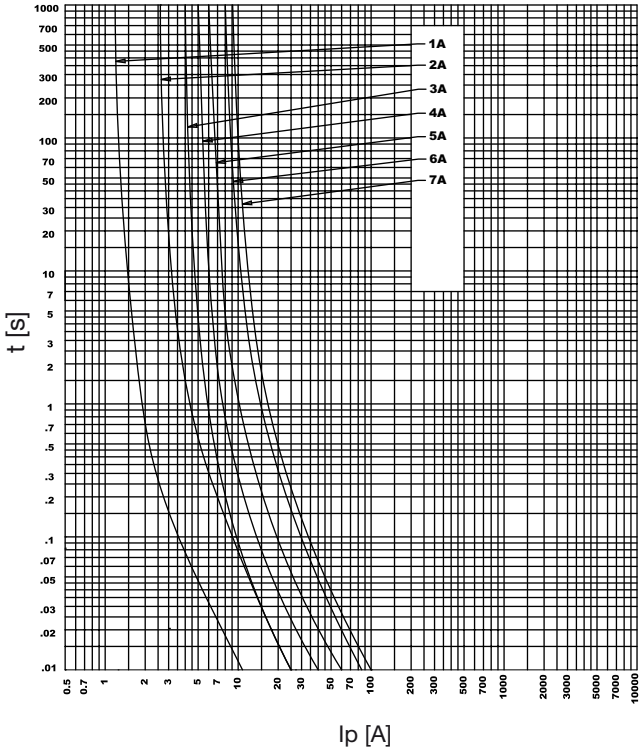

Melting time - Current data

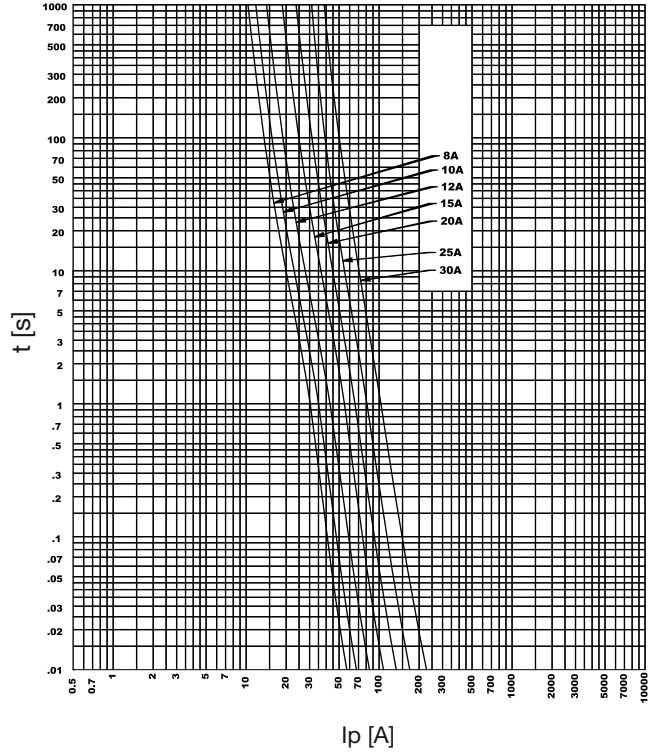

Voltage capabilities vs. time constant

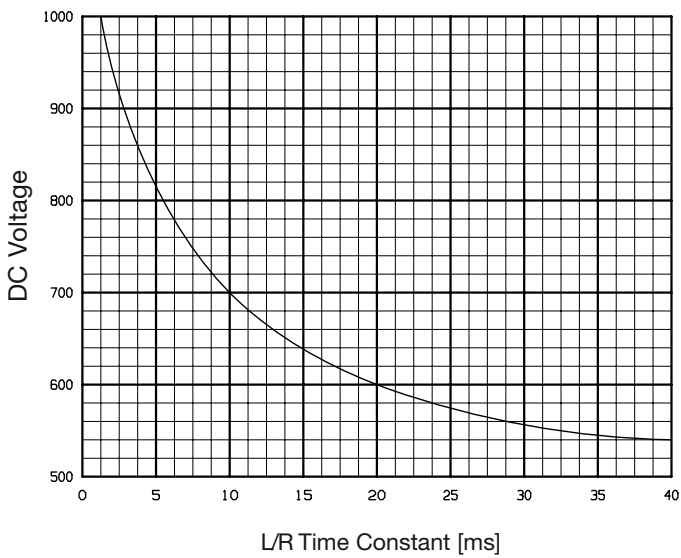

2CSC400048F0202

Switch-disconnector ILTS-E for D0 2-63 A fuse links “Drawer technology”

User-friendly fuse-switch-disconnector in “drawer technology”:

- Snap action
- Fuse can be replaced only if the system is de-energized.
- Captive fuse carrier
- For D02 fuse links, D01 fuse link with reducing piece
- Twin box terminal on both sides
- User-friendly installation of cross-wiring in lower terminal
- Auxiliary switch to indicate switching position

Fuse-switch-disconnector

Poles	Order details Type code	Order code	Bbn 4016779 EAN	Price 1 piece	Price group	Weight 1 piece kg	Pack unit pc.
1	ILTS-E1	2CDE 101 001 R1901	65347 3		13	0.210	3
2	ILTS-E2	2CDE 102 001 R1901	65348 0		13	0.420	2
3	ILTS-E3	2CDE 103 001 R1901	65349 7		13	0.630	1
3+N*	ILTS-E3+N	2CDE 103 101 R1901	65350 3		13	0.790	1
Reducing piece	ILTS-E/RE	2CDE 000 011 R1901	65407 4		13	0.001	20
Auxiliary switch 1NO/1NC	LTS-E/H11	2CDE 000 012 R1901	65671 9		13	0.050	1

* N conductor leading make contact, late closing

Technical data

Standards:	DIN VDE 0638, EN 60947-3, EN 660269-3-1
Approval:	VDE
No. of poles:	1, 2, 3 pole and 3 pole+N
Rated voltage:	400 V AC, per pole 65 V DC (2 pole 130 V DC)
Operating current I_n:	acc. to fuse link D0 2-63 A
Rated frequency:	50/60 Hz
Rated short circuit capacity:	50 kA for AC (8 kA for DC)
Power loss:	5.5 W/pole
Utilization category:	AC 22 B: 400 V AC 63 A according to IEC / EN 60947-3 (all versions) DC 22 B: 65 V DC 63 A according to IEC / EN 60947-3 (1 pole) DC 22 B: 130 V DC 63 A according to IEC / EN 60947-3 (2 pole)
Leakage current resistance:	CTI 200
Ambient temperature:	- 5 °C up to + 40 °C
Casing material:	thermoplast; halogen-, phosphor-, silicone- and CFC-free
Fire classification:	UL 94 (self-extinguishing)
Shock protection:	according to DIN EN 50 274 (DIN VDE 0660 Part 514) BGV A3
Connection capacity:	1.5 – 35 mm ² finely stranded, directly clamped or with connector sleeve Twin-function terminal for simultaneous connection of two conductors (35 mm ² and 16 mm ²) or conductor and busbar
Pick-up torque:	2,5 – 3 Nm
Auxiliary switch indicating contact position	
Contacts:	1 NO contact + 1 NC contact
Contact rating:	AC 13: 2 A/400 V, 6 A/230 V DC 13: 1 A/220 V, 6 A/24V



Circuit





ISS 16/1

2CDC 051 109 F0007



ISS 63/1

2CDC 051 110 F0007



ISS 16/3

2CDC 051 111 F0007



ISS 63/3

2CDC 051 112 F0007

D0 fuse carrier ISS with integrated red cover

D0 fuse base for NEOZED fuse links D01 / D02. Touch-protection according to BGV A3. Twin box terminal on both sides for connection of two different conductor cross-sections or conductors and busbars.

Conductor cross-sections incoming and outgoing 1.5 – 35 mm², stranded. With integrated terminal cover. **A separate cover for distribution board installation is not required.**

- IEC 60269-3 / VDE 0636-3
- 1/3-pole
- Fuse links, connector sleeves VDE 0636-3
- Snap clip device for rail mounting to EN 60715
- Twin function terminal
- Connection cross-section 1.5 – 35 mm²
- Tightening torque 2.5 – 3 Nm

D0 fuse carrier

Poles	Screw cover/ fuse	Order details		Bbn 4016779	Price 1 piece	Price group	Weight 1 piece kg	Pack unit pc.
		Type code	Order code					
1	E14 D01	ISS 16/1	2CDE 101 001 R1902	65579 8		13	0.08	3
1	E18 D02	ISS 63/1	2CDE 161 001 R1902	65581 1		13	0.08	3
3	E14 D01	ISS 16/3	2CDE 113 001 R1902	65580 4		13	0.24	3
3	E18 D02	ISS 63/3	2CDE 163 001 R1902	65582 8		13	0.24	3

Technical data

Size:	D01	D02
Current type:	AC (50 Hz) / DC	AC (50 Hz) / DC
Rated voltage:	400 V AC / 250 V DC	400 V AC / 250 V DC
Rated current:	16 A	63 A
Rated short-circuit current:	50 kA (AC) 8 kA (DC)	50 kA (AC) 8 kA (DC)
For fuse links with losses per phase up to:	2.5 W	5.5 W

Dimensions in mm

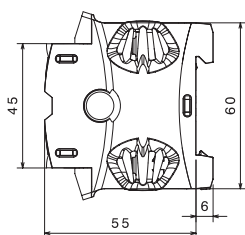

ISS 16/1
ISS 63/1

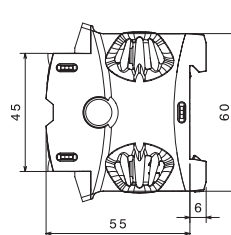
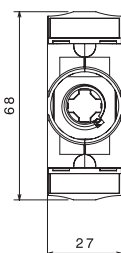

ISS 16/3
ISS 63/3

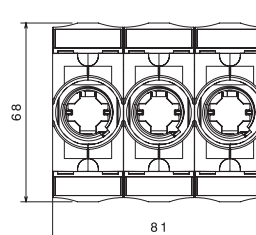

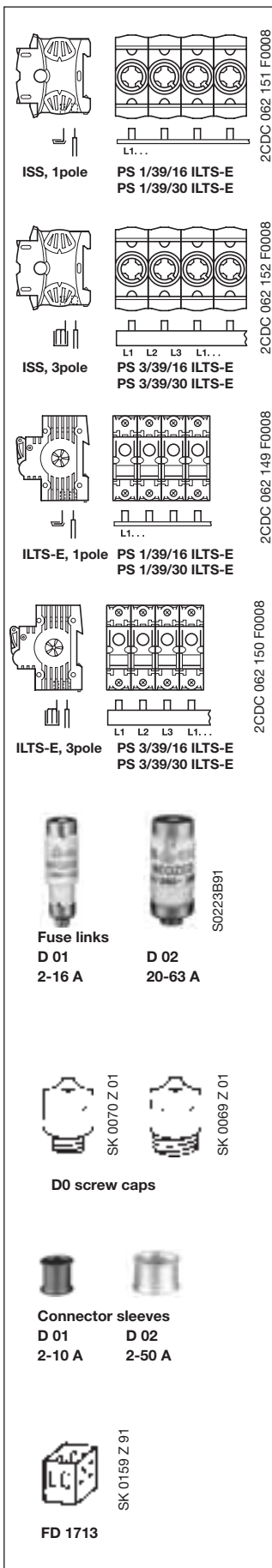

Cross-section	Length	No. of poles	Order details		bbn	Cu	Price	Price	Weight	Pack
mm ²	mm		Type code	Order code	40 12233	factor	1 piece	group	1 piece	unit
					EAN				kg	pc.
Busbars for fuse-switch-disconnector ILTS-E and fuse carrier ISS: 1pole oder 3pole										
16	1040	39 x 1	PS 1/39/16 ILTS-E	2CDL 010 101 R1639	66956 6 ^①	0.43		15	0.23	10
30	1040	39 x 1	PS 1/39/30 ILTS-E	2CDL 010 101 R3039	66957 3 ^①	0.74		15	0.487	5
16	1040	39 x 3	PS 3/39/16 ILTS-E	2CDL 030 101 R1639	66958 0 ^①	1.3		15	0.59	10
30	1040	39 x 3	PS 3/39/30 ILTS-E	2CDL 030 101 R3039	66959 7 ^①	1.95		15	1.222	5

① bbn-Nr. 40 16779

End caps

		Order details	bbn	Price	Price	Weight	Pack
		Type code	40 12233	1 piece	group	1 piece	unit
			EAN			kg	pc.
1	END 1.1	2CDL 200 011 R0011	63891 3	15	0.001	50	
2/3	PS-END	2CDL 200 001 R0001	51472 9	15	0.001	50	
2/3	PS-END 3	2CDL 200 001 R3001	65430 2	15	0.001	50	
1	PS-END 3.2	2CDL 200 001 R3003	66960 3	15	0.001	50	

D0 fuses and accessories

Rated current	Colour code	Power loss	Order details		bbn	Price	Price	Weight	Pack
A		W	Type code	Order code	40 12233	1 piece	group	1 piece	unit
					EAN			kg	pc.

D0 fuse links to DIN VDE 0636-3, IEC/EN 60269-3

suitable for D01/E14

2	pink	1.5	D01 x 2 gL	GMN 977 120 P0011	60480 7	13	0.006	10
4	brown	1.5	D01 x 4 gL	GMN 977 120 P0012	60490 6	13	0.006	
6	green	1.5	D01 x 6 gL	GMN 977 120 P0013	60500 2	13	0.006	
10	red	1.8	D01 x 10 gL	GMN 977 120 P0014	60510 1	13	0.006	
16	grey	2.1	D01 x 16 gL	GMN 977 120 P0015	60520 0	13	0.006	

Suitable for D02/E18

20	blue	2.3	D02 x 20 gL	GMN 977 120 P0017	60530 9	13	0.011	10
25	yellow	2.6	D02 x 25 gL	GMN 977 120 P0018	60540 8	13	0.012	
35	black	2.9	D02 x 35 gL	GMN 977 120 P0019	60550 7	13	0.013	
50	white	3.5	D02 x 50 gL	GMN 977 120 P0020	60560 6	13	0.014	
63	copper	4.2	D02 x 63 gL	GMN 977 120 P0021	60570 5	13	0.015	

D0 screw caps acc. to DIN VDE 0636-3, IEC/EN 60269-3, 400 V AC

Plastic version, RAL 7037

16	for D01	-	D01 DIN 49 525 K	GMN 977 130 P0011	60790 7	13	0.015	20
63	for D02	-	D02 DIN 49 525 K	GMN 977 130 P0012	60800 3	13	0.015	20

D0 connector sleeves to DIN VDE 0636-3, IEC/EN 60269-3

Suitable for D01/E14

2	pink	-	D01 x 2	GMN 977 125 P0001	60600 9	13	0.001	50
4	brown		D01 x 4	GMN 977 125 P0002	60610 8	13	0.001	
6	green		D01 x 6	GMN 977 125 P0003	60620 7	13	0.001	
10	red		D01 x 10	GMN 977 125 P0004	60630 6	13	0.001	

Suitable for D02/E18

2	pink	-	D02 x 2	GMN 977 125 P0011	60640 5	13	0.001	50
4	brown		D02 x 4	GMN 977 125 P0012	60650 4	13	0.001	
6	green		D02 x 6	GMN 977 125 P0013	60660 3	13	0.001	
10	red		D02 x 10	GMN 977 125 P0014	60670 2	13	0.001	
16	grey		D02 x 16	GMN 977 125 P0015	60680 1	13	0.001	
20	blue		D02 x 20	GMN 977 125 P0016	60690 0	13	0.001	
25	yellow		D02 x 25	GMN 977 125 P0017	60700 6	13	0.001	
35	black		D02 x 35	GMN 977 125 P0018	60710 5	13	0.001	
50	white		D02 x 50	GMN 977 125 P0019	60720 4	13	0.001	

Spring clip for use of D01 fuses in D02 screw caps

	FD 1713	GMN 977 130 P0004	15120 7 ^①	13	0.001	50
--	---------	-------------------	----------------------	----	-------	----

① bbn-Nr. 40 16779

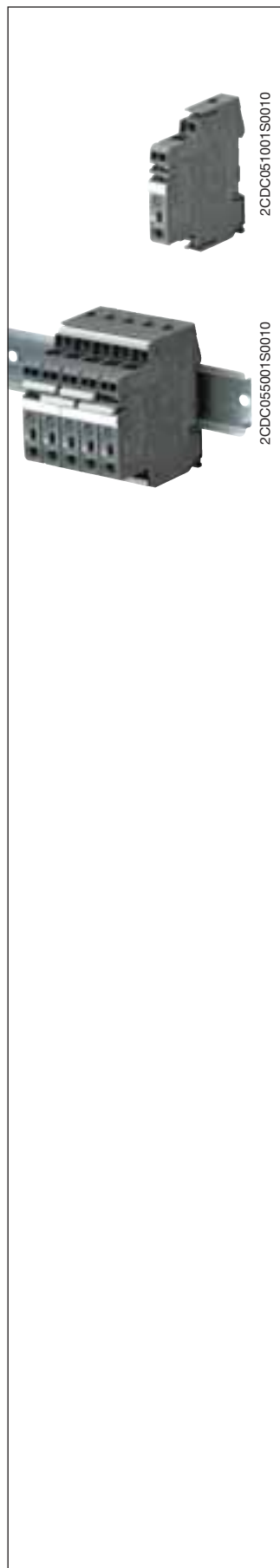

The protection devices EPD24 extend the ABB product range of modular DIN rail components by electronic overcurrent protection modules for selective protection of 24V DC load circuits.

This protection is achieved by a combination of active electronic current limitation in the case of a short circuit and an overload deactivation from $1.1 \times I_n$ upwards.

If a fault occurs in a load circuit, the protection device EPD24 will detect this rapidly and reliably, disable the power output transistor and hence interrupt the current flow in the defective circuit. The maximum possible overcurrent is always limited to 1.5...1.8 times the selected rated current. An activation of capacitive loads up to 20,000 μF is possible, deactivation only occurring in the case of overloads or short circuits. Selective deactivation of the defective current circuit means undefined error states and a complete system stop are prevented.

Features

- Selective load protection, one electronic trip characteristics.
- Active current limitation for safe connection of capacitive loads up to 20,000 μF and on overload/short circuit.
- Current ratings 0.5 A...12 A.
- Reliable overload disconnection with $1.1 \times I_n$
- Manual ON/OFF button
- Clear status and failure indication through LED and auxiliary contact.
- Integral fail-safe element adjusted to current rating.
- Width per unit only 12.5 mm.
- Rail mounting
- Ease of wiring through busbar LINE+ and 0 V as well as signal bars.
- UL- and CSA-approvals allow international use of the devices.

Selection table

Rated current I_n in A	Order details		bbn 40 16779 EAN	Price 1 piece	Price group	Weight 1 piece kg	Pack unit pc.
	Type code	Order code					
0.5	EPD24-TB-101-0.5A	2CDE 601 101 R2905	829960			0.065	4
1	EPD24-TB-101-1A	2CDE 601 101 R2001	829984			0.065	4
2	EPD24-TB-101-2A	2CDE 601 101 R2002	830003			0.065	4
3	EPD24-TB-101-3A	2CDE 601 101 R2003	830027			0.065	4
4	EPD24-TB-101-4A	2CDE 601 101 R2004	830041			0.065	4
6	EPD24-TB-101-6A	2CDE 601 101 R2006	830065			0.065	4
8	EPD24-TB-101-8A	2CDE 601 101 R2008	830089			0.065	4
10	EPD24-TB-101-10A	2CDE 601 101 R2010	830102			0.065	4
12	EPD24-TB-101-12A	2CDE 601 101 R2012	830126			0.065	4

Selection table accessories

	Order details		bbn 40 16779 EAN	Price 1 piece	Price group	Weight 1 piece kg	Pack unit pc.
	Type code	Order code					
Busbars for LINE+ and 0 V, grey insulation, length 500 mm ¹⁾	EPD-BB500	2CDE 605 100 R0500	830140			0.20	10
Signal Bars for aux. contacts, grey insulation, length 21 mm	EPD-SB21	2CDE 605 200 R0021	830164			0.04	10

1) Max. load with one line entry $I_{max} = 50$ A (recommended: center-feeding)
Max. load with two line entries $I_{max} = 63$ A

Wiring diagramm

EPD24-TB-101

without signal input
with signal output F
(single signal, NO)

Operating condition: 13-14 closed
Fault condition: 13-14 open

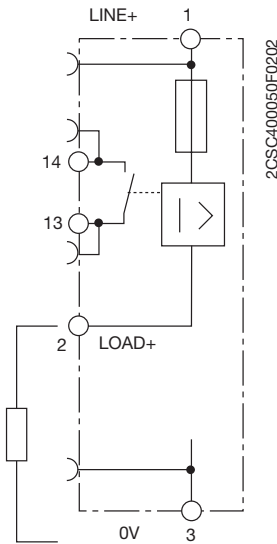

Operating data

Operating voltage U_B:	24 V DC (18...32 V)
Current rating I_N:	fixed current ratings: 0.5, 1, 2, 3, 4, 6, 8, 10, 12 A
Closed current I_c:	ON condition: typically 20...30 mA depending on signal output
Status indication by means of:	<ul style="list-style-type: none"> - multicolour LED: <ul style="list-style-type: none"> Green: - unit is ON (S1 = ON) - load circuit / Power-MOSFET is switched on Orange: - in the event of overload or short circuit until electronic disconnection Red: - unit electronically disconnected - load circuit/Power-MOSFET OFF - undervoltage ($U_B < 8 \text{ V}$) - after switch-on till the end of the delay period OFF: - manually switched off (S1 = OFF) or device is dead
	- potential-free auxiliary contact F
	- ON/OFF/ condition of switch S1

Load circuit

Load output	Power-MOSFET switching output (high slide switch)
Overload disconnection	typically $1.1 \times I_N$ ($1.05...1.35 \times I_N$)
Short-circuit current I_k	active current limitation (see table 1)
Trip time	see time/current characteristics
For electronic disconnection	typically 3 s at $I_{Load} > 1.1 \times I_N$ typically 100 ms...3 s at $I_{Load} > 1.8 \times I_N$ (or $1.5 \times I_N / 1.3 \times I_N$)
Temperature disconnection	internal temperature monitoring with electronic disconnection
Low voltage monitoring load output	with hysteresis, no reset required: load »OFF« at $U_B < 8 \text{ V}$
Starting delay t_{start}	typically 0.5 sec after every switch-on and after applying U_S
Disconnection of load circuit	electronic disconnection
Free-wheeling circuit	suitable external free-wheeling circuit to be used with inductive load
Several load outputs must not be connected in parallel	

Signal output F

Electrical data	potential-free auxiliary contact max. 30 V DC/0.5 A, min. 10 V DC/10 mA
ON condition LED green	voltage U_B applied, switch S1 is in ON position no overload, no short circuit
OFF condition LED off	- device switched off (switch S1 is in OFF position) - no voltage U_B applied
Fault condition LED orange	overload condition $> 1.1 \times I_N$ up to electronic disconnection
Fault condition LED red	- electronic disconnection upon overload or short circuit - Device switched off with control signal (switch S1 is in ON position)
Aux. contact	single signal, make contact contact open, terminal 13-14
Fault	signal output fault conditions - no operating voltage U_B - ON/OFF switch S1 is in OFF position - red LED lighted (electronic disconnection)

General data

Fail-Safe element	backup fuse for EPD24 not required because of the integral redundant fail-safe element
Housing material	moulded
Mounting	symmetrical rail to EN 50022-35x7.5
Ambient temperature	0...+50 °C (without condensation, see EN 60204-1)
Storage temperature	-20...+70 °C
Humidity	96 hrs/95 % RH/40 °C to IEC 60068-2-78, test Cab. climate class 3K3 to EN 60721
Vibration	3 g, test to IEC 60068-2-6 test Fc
Degree of protection	housing: IP20 DIN 40050 terminals: IP20 DIN 40050
EMC (EMC directive, CE logo)	emission: EN 61000-6-3 susceptibility: EN 61000-6-2
Isolations coordination (IEC 60934)	0.5 kV/pollution degree 2 reinforced insulation in operating area
Dielectric strength	max. 32 V DC (load circuit)
Isolation resistance (OFF condition)	n/a, only electronic disconnection
Approvals/Declarations of conformity	UL 2367 Solid State Overcurrent Protectors UL 1604, (class I, division 2, groups A, B, C, D) UL 508 CSA C22.2 No. 213 (class I, division 2) CSA C22.2 No. 142 CE logo
Dimensions (B x H x T)	12.5 x 80 x 83 mm
Weight	approx. 65 g

Terminals **Line+/LOAD+/0V**

Screw terminals	M4
Max. cable cross section flexible with wire end ferrule w/wo plastic sleeve	0.5 – 10 mm ²
Multi-lead connection (2 identical cables) rigid/flexible	0.5 – 4 mm ²
Flexible with wire end ferrule without plastic sleeve	0.5 – 2.5 mm ²
Flexible with TWIN wire end ferrule with plastic sleeve	0.5 – 6 mm ²
Wire stripping length	10 mm
Tightening torque (EN 60934)	1.5 – 1.8 Nm

Terminals **aux. contacts**

Screw terminals	M3
Max. cable cross section flexible with wire end ferrule w/wo plastic sleeve	0.25 - 2.5 mm ²
Wire stripping length	8 mm
Tightening torque (EN 60934)	0.5 Nm

Table 1: voltage drop, current limitation, max. load current

current rating I_N	typically voltage drop U_{ON} at I_N	active current limitation (typically)	max. load current at 100 % ON duty	
			$T_{ambient} = 40\text{ °C}$	$T_{ambient} = 40\text{ °C}$
0.5 A	70 mV	$1.8 \times I_N$	0.5 A	0.5 A
1 A	80 mV	$1.8 \times I_N$	1 A	1 A
2 A	130 mV	$1.8 \times I_N$	2 A	2 A
3 A	80 mV	$1.8 \times I_N$	3 A	3 A
4 A	100 mV	$1.8 \times I_N$	4 A	4 A
6 A	130 mV	$1.8 \times I_N$	6 A	5 A
8 A	120 mV	$1.5 \times I_N$	8 A	7 A
10 A	150 mV	$1.5 \times I_N$	10 A	9 A
12 A	180 mV	$1.3 \times I_N$	12 A	10.8 A

Attention: when mounted side-by-side without convection the EPD24 should not carry more than 80 % of its rated load with 100% ON duty due to thermal effects.

H+Line

- H** like Hospital
- +** like health and first aid
- +** like the countless advantages of ABB products

Solutions for the hospital sector

ABB's extensive experience in the hospital field is certified by several installations in leading hospitals, which represent the current leading-edge in safety and technology. Over the years, ABB has developed an increasingly more complete product with higher performance to meet the needs of more demanding customers and guarantee patient and operator safety.





H+Line products are specifically designed for group 2 medical environments in full compliance with Standard IEC 60364-7-710, specifically:

- Intensive therapy wards, operating theatres, cardio surgical rooms, ICU...
- Day hospitals, clinics, rest homes, dental and veterinary clinics, etc.

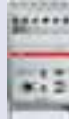

5

H+Line product range

ISOLTESTER		Insulation monitoring device for IT-M 230 V circuits
SELVTESTER		Insulation monitoring device for SELV 24 V circuits which supply scialitic lamps.
QSD		Remote signalling panel for visual and acoustic fault indication.
TI		Medical insulating transformers for insulated protection systems.
QSO		Wall mounting and floor standing switchboards for medical locations.



Valid assistance for consultants

Everyone knows what the regulations say. ABB tells you what they don't say. The "Practical guide to group 2 medical locations" is designed to be a useful daily tool for consultants and installers to help them in each group 2 hospital electrical system designing and installation.

The document was developed together with ABB customers with the intent to support key regulatory questions with practical solutions, considerations and recommendations on system design. This way, the "Practical guide to group 2 medical locations" is a valid tool, with plenty of examples, to support consultants in their daily job.



Assuring operational continuity in medical environments, even in presence of first earthing fault, it's mandatory in operating theatre group 2 medical locations. For this reason an IT distribution system with insulating transformer is used to supply medical equipment.

ISOLTESTER-DIG

ISOLTESTER range of insulation monitoring device allows IT-M network monitoring, assuring safety for patients and medical personnel avoiding supply interruption in case of first earthing fault according to IEC 60364-7-710 Standard.

The ISOLTESTER-DIG range assures safety to patients and medical personnel, signalling when a fault to earth occurs. Thanks to its innovative technology it is used to sense the insulation level of the network by far more efficiently compared to traditional insulation monitoring devices.

Advanced features	Order details		Bbn 8012542	Price 1 piece	Price group	Weight 1 piece kg	Packing unit pc.
	Type code	Order code	EAN				
	ISOLTESTER-DIG-RZ	2CSM244000R1501	884507			0.500	1
RS485, Max-Min values, Programmable relay	ISOLTESTER-DIG-PLUS	2CSM341000R1501	884606			0.500	1

Functioning of the frontal operators

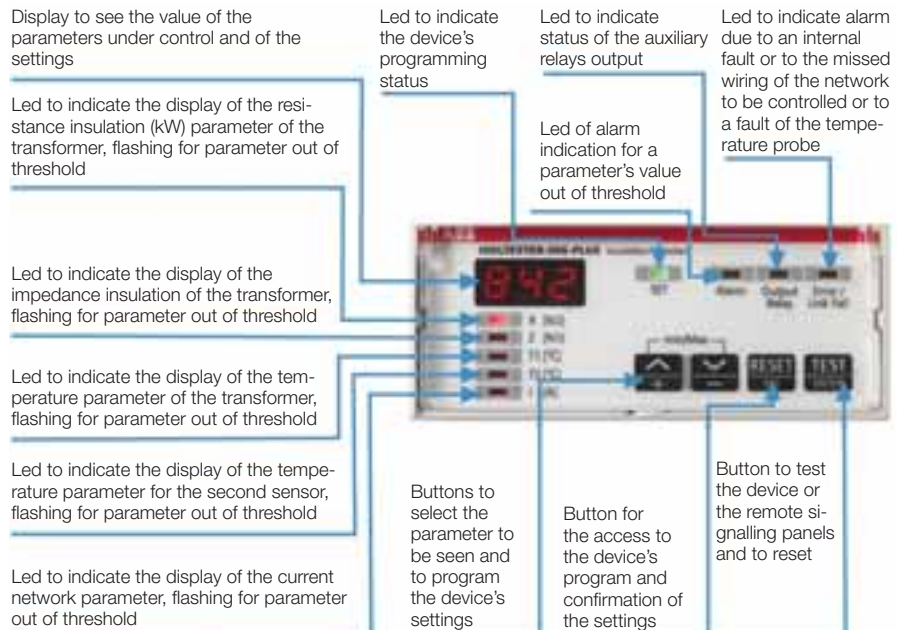

Technical features

	ISOLTESTER-DIG-PLUS	ISOLTESTER-DIG-RZ
Rated	110 - 230 V/50-60 Hz	
Network voltage to be controlled	24÷230 V a.c.	
Voltage max. measure	24 V	
Current max. measure	1 mA	
Insulation voltage	2.5 kV/60 sec.	
Type of control's signal	Codified signal	Direct component with digital filter
Sensed measures	Measure range 0 ÷ 999 kohm/HIGH - resolution 1 kohm	
	Thermal-probe temperature PT100 0÷250 °C, accuracy 2%	
	Current measure from external T.A. with secondary 5 A , accuracy 2% (selectable statement value T.A. 1÷200)	
	Impedance measure 0 ÷ 999 Kohm/HIGH - resolution 1 Kohm (codified composed signal)	Impedance measure 0 ÷ 999 Kohm/HIGH - resolution 1 Kohm (test signal 2500 Hz)
Intervention threshold	Low insulation 50 ÷ 500 kohm, accuracy 5%, hysteresis 5%, delay which can be setted	
	Overtemperature 0 ÷ 200 °C, accuracy 2%	
	Overload current 1 ÷ 999 A, accuracy 2%	
	Low impedance (which can be disarmed)	
	Link-Fail	
Available output	Max. up to 4 QSD panels for remote signalling	Max. up to 2 QSD panels for remote signalling
	Programmable auxiliary relays output NA-C-NC, 5 A, 250 VAC	
	Serial output RS485 , standard protocol Modbus-rtu	-
Displays	Insulation resistance value with signalling of over fullscale value and direct earth fault	
	Value of measured temperature 0 ÷ 200 °C per channel 1	
	Value of measured temperature 0 ÷ 200 °C per channel 2	
	Value of measured current 0 ÷ 999 A	
	Value insulation impedance	
	Value of network capacity to earth	-
	Setting parameters	
	Link-Fail	
	Relays output status	
	Memorization of min. insulation	-
Max. temperature and current values	-	
Connection	Max. section 2.5 sqmm	
Operating temperature	-10 ÷ 60 °C	
Storage temperature	-25 ÷ 70 °C, humidity < 90%	
Dimensions	6 modules DIN	
Weight	0.5 kg	
Housing	Plastic self-extinguishing housing for 35 mm, with transparent sealable plate	
Protection degree	IP20	
Self-consumption	5 VA	
Reference standard	IEC 61557-8, IEC 60364-7-710, IEC 60255-6	



2CSC400404F0201

SELVTESTER for insulated networks at 24 V a.c/d.c.

It is used to monitor permanently the insulation of safety extremely low voltage circuits (up to 24 V) especially scialitic lamps.

Function	Order details		Bbn	Price 1 piece	Price group	Weight 1 piece kg	Packing unit pc.
	Type code	Order code	EAN				
Insulation monitoring	SELVTESTER-24	2CSM211000R1511	884705			0.250	1



2CSC400693F0001

QSD remote signalling panel

They are installed in combination with insulation monitoring devices, to remotely report the signalling generated by these devices. They can be installed together with ISOLTESTER-DIG and SELVTESTER-24 and they are compatible also with former versions of insulating monitoring devices. Flush mounting box already included in the packaging.

Version	Order details		Bbn	Price 1 piece	Price group	Weight 1 piece kg	Packing unit pc.
	Type code	Order code	EAN				
Horizontal	QSD-DIG 230/24	2CSM273063R1521	730637			0.800	1
Vertical	QSD-DIG 230/24 V	2CSM257093R1521	570936			0.800	1

H+Line

5

Technical features of SELVTESTER

Network voltage and auxiliary power supply	24 V 50-60 Hz/d.c. ± 20%
Max power dissipation	3 VA – 3 W
Max measuring current	max. 0,5 mA
Internal impedance	50 kohm
Activation threshold setting	programmable to 10 ÷ 50 kohm (4 levels using microswitches)
Activation delay	about 1 second
Signals	led ON, led ALARM +, led ALARM -
Output	for up to 2 QSD-230/24-C, max. 24 V 1 A remote panels
Operating / storage temperature	-10 ÷ 60 °C / -20 ÷ 70 °C
Relative humidity	≤ 95%
Insulation test	2,5 kV 60 sec. / 4 kV imp. 1,2/50µs
Terminal cross section	4 mm ²
Front degree of protection	IP40 with cover / IP20 container
Modules	3
Weight	200 g
Reference standards for safety	IEC 60364-7-710, EN 61326-1, EN 61010-1

Technical features of QSD

Signals	green led network, red led overload ALARM, yellow led low insulation FAULT ALARM, acoustic signaller, emission 2400 Hz intermittence 2 Hz dB
Buttons	TEST and MUTE buttons
Terminal cross section	2,5 mm ²
Degree of protection	IP30
Installation	universal flush-mounted box
Weight	200 g
Operating temperature	-10 ÷ 60 °C, max. humidity 95%
Storage temperature	-25 ÷ +80 °C
Insulation	2500 Vrms 50 Hz 60 s
Cables section	0.35 mm ² for 300 m
Compatibility	ISOLTESTER-C, ISOLTESTER-RZ, ISOLTESTER-DIG-RZ, ISOLTESTER-DIG, PLUS, SELVTESTER-C, SELVTESTER-24
Reference standards	safety EN 61010-1 product EN 61557-8 / IEC 60364-7-710 / UNE 20615 electromagnetic compatibility EN 61326-1



Insulating transformers for medical locations

Permanently connected to an IT power supply system, single-phase medical insulating transformers provide galvanic separation between the distribution network and the user load in accordance with IEC EN 61558-2-15 concerning power supply group 2 medical locations.

Rated Output KVA	PT100	Order details Type code	Order code	Bbn 801254 EAN	Price 1 piece	Price group	Weight 1 piece kg	Pack unit pc.
3		TI 3	2CSM110000R1541	2896005			29.5	1
5		TI 5	2CSM120000R1541	2896104			44.0	1
7.5		TI 7.5	2CSM130000R1541	2896203			50.5	1
10		TI 10	2CSM140000R1541	2521204			73.0	1
3	■	TI 3-S	2CSM210000R1541	2521402			29.5	1
5	■	TI 5-S	2CSM220000R1541	2521501			44.0	1
7.5	■	TI 7.5-S	2CSM230000R1541	2521600			50.5	1
10	■	TI 10-S	2CSM240000R1541	2521709			73.0	1

Accessories for insulating transformers for medical locations

	Order details Type code	Order code	Bbn 801254 EAN	Price 1 piece	Price group	Weight 1 piece kg	Pack unit pc.
Shock absorber	AMM	2CSM900000R1541	2557920			1	4

Serial number location



Technical characteristics

	[KVA]	3	5	7,5	10
Rated output	[KVA]	3	5	7,5	10
Frequency	[Hz]	50-60			
Power dissipation	[W]	120	150	280	320
Electrical protection class		1			
Thermal insulation class	[°C]	B 130	B 130	F 155	F 155
Operating temperature max	[°C]	40			
Primary winding voltage	[V]	230			
Secondary winding voltage	[V]	230			
No load current	[A]	< 0.39	< 0.65	< 0.98	< 1.3
Short circuit voltage drop		<3%			
Inrush current	[A]	< 221	< 369	< 553	< 738
Power loss	[W]	120	150	260	320
Winding separation		double insulation			
Metallic shield		■			
Reference standard		IEC-EN 61558-1, IEC-EN 61558-2-15, IEC-EN 62041			
Dimensions	[mm]	205x340x150	240x380x150	240x380x160	277x380x260

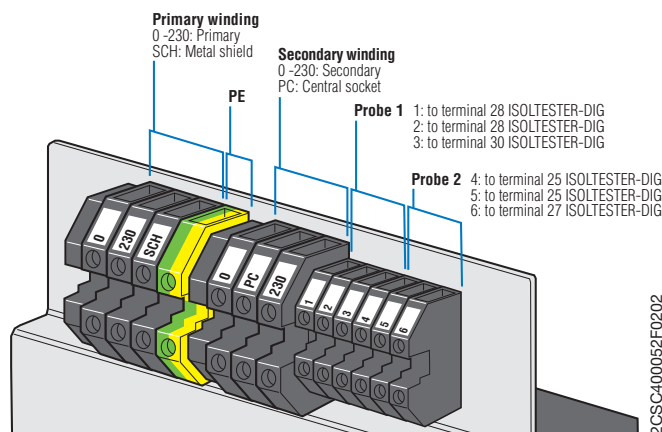



Electrical switchboard for medical locations

Electrical switchboards for operating theatres incorporate all the latest ABB modular instrumentation. They are the ideal solution for distribution within group II medical locations, allowing monitoring of all network parameters and control of the 24 V a.c. supply line to the scialtic lamp. ABB panels are assambled with ArTu switchgears and are provided with instruction manual and declaration of conformity required for commissioning, thus guaranteeing installers compliance with all regulations.

Power	PT100 sensor	SELV circuit	Order details	Bbn	Price	Price group	Weight	Pack unit
KVA			Type code	Order code	801254	1 piece	1 piece	kg pc.
				EAN				

Wall mounted electrical switchboard for medical locations

3			QSO 3kVA	2CSM110000R1551	2376101		100.0	1
5			QSO 5kVA	2CSM120000R1551	2376200		104.5	1
7.5			QSO 7.5kVA	2CSM130000R1551	2376309		121.0	1
3	■		QSO 3kVA-S	2CSM210000R1551	2526308		100.0	1
5	■		QSO 5kVA-S	2CSM220000R1551	376200		104.5	1
7.5	■		QSO 7.5kVA-S	2CSM230000R1551	2526506		121.0	1

Floor standing electrical switchboard for medical locations

3	■		QSO 3kVA-S-PV	2CSM310000R1551	2526605		161.5	1
5	■		QSO 5kVA-S-PV	2CSM320000R1551	2526704		176.0	1
7.5	■		QSO 7.5kVA-S-PV	2CSM330000R1551	2526803		182.5	1
10	■		QSO 10kVA-S-PV	2CSM340000R1551	2526902		205.0	1
3	■	■	QSO 3kVA-S-PV+24Vac	2CSM410000R1551	2614302		161.5	1
5	■	■	QSO 5kVA-S-PV+24Vac	2CSM420000R1551	2614401		176	1
7.5	■	■	QSO 7.5kVA-S-PV+24Vac	2CSM430000R1551	2614500		182.5	1
10	■	■	QSO 10kVA-S-PV+24Vac	2CSM440000R1551	2614609		205	1

Technical characteristics

Rated voltage	[V]	230 ± 15% a.c.
Rated frequency	[Hz]	50
Number of phases		1 + N ~ / PE
Auxiliary circuits rated voltage	[V]	230 a.c.
Insulation rated voltage	[V]	300 - 2,500
Distribution system		TT / TN-S
Max short circuit current	[kA]	6 RMS sym
Max altitude	[m]	2000 a.s.l
Contamination level		1 absent or only dry and non conducting
Resistance to impact		IK09
Protection degree		IP65 front with door - IP31 front without door - IP20 on top
Relative humidity		50%
Operating temperature	[°C]	- 5 / + 40
Storage temperature	[°C]	- 25 / + 55
Reference standard		IEC 60364-7-710; EN60439-1

Insulation monitoring devices

In IT electrical distribution networks with isolated neutral, the high insulation impedance prevents earth faults from generating currents that would dangerously elevate the potential of exposed conductive parts. Therefore, in case of earth leakage in an IT network it is not necessary to interrupt the supply, but it is still essential to continually monitor the insulation level in order to detect faults and restore optimal functioning of the system.

In industrial installations, IT networks are used when operational continuity is an intrinsic requirement of the production process, due to both technical and economic considerations. Such applications include: metalworking and chemical industries, explosion risk locations, railway lines and vehicles, uninterruptible power supplies, cinema sets, emergency lines, fire water pumps and emergency lighting.



Monitored line voltage	Order details	Bbn	Price	Price	Weight	Pack
Type code	Order code	EAN	1 piece	group	1 piece	unit
					kg	pc.

Insulation monitoring devices for a.c. networks

220-240 V a.c.	ISL-C 230	2CSM444000R1500	942801		0.300	1
380-415 V a.c.	ISL-C 440	2CSM545000R1500	942900		0.300	1
60-760 V a.c.	ISL-C 600	2CSM656000R1500	943006		0.500	1

Insulation monitoring devices for d.c. networks

100-144 V d.c.	ISL-A 115	2CSM222000R1500	942603		0.500	1
220 V d.c.	ISL-A 230	2CSM333000R1500	942702		0.500	1
400-600 V d.c.	ISL-A 600	2CSM249853R1500	498537		0.500	1

Insulation monitoring devices for a.c./d.c. networks

24-28 V a.c./d.c.	ISL-A 24-48	2CSM111000R1500	942504		0.300	1
-------------------	--------------------	-----------------	---------------	--	-------	---

Insulation monitoring devices for voltageless network

20-700 V a.c./d.c.	ISL-MOT 1000	2CSM808000R1500	943204		0.300	1
--------------------	---------------------	-----------------	---------------	--	-------	---

Technical features ISL-A

	ISL-A		
	24-48	115 and 230	400-600
Power consumption [VA]	3	4	6
ALARM threshold [kΩ]		30 - 300	
TRIP threshold [kΩ]	10 - 60	10 - 100	30 - 300
LED indications			
ON	■	■	■
TRIP	■	■	■
ALARM	■	■	■
+/-	■	■	■
Max trip delay [s]	0.2	2	2.5
Max measuring current [mA]	0.5	1.8	1.5
Max measuring voltage [V]		12	
Internal impedance [kΩ]	50	100	880 kΩ L+/L - 450 kΩ L/PE
TRIP relay output	1 NO-C-NC	2 NO-C-NC	1 NO-C-NC
ALARM relay output		2 NO-C-NC	
Relay contact capacity		max 250 V, 5 A	
Programmed functions			
Alarm output		■	
Fail safe		■	
Reset		■	
Insulation test	2.5 kV60 sec. / 4 kV imp 1.2/50 μs	2.5 kV 60 sec. / 4 kV imp 1.2/50 μs	2.5 kV 60 sec. / 6 kV imp 1.2/50 μs
Operating temperature [°C]		-10 ÷ 60	
Storage temperature [°C]		-20 ÷ 70	
Relative humidity		≤ 95%	
Max terminal section [mm ²]	4	2.5	2.5
Protection degree		IP40 front, IP20 enclosure	
Modules	3	6	6
Weight [g]	200	400	400
Reference standards	EN 61010-1, EN 61557-8, EN 61326-1		

Technical features ISL-C and ISL-MOT

		230	ISL-C 440	600	ISL-MOT 1000
Auxiliary power supply	[V]	220-240 a.c./d.c.		110-230 a.c.	220 a.c.
Power consumption	[VA]	3	3	5	3
TRIP threshold	[kΩ]	100	10 -150	10-100	0.1 - 1000
LED indications					
ON		■	■	■	■
TRIP		■	■	■	■
ALARM				■	
Max trip delay	[s]	1	4	5	0.2
Max measuring current	[mA]	0.1	0.1	0.25	0.0015
Max measuring voltage	[V]	12		48	20
Internal impedance	[kΩ]	250	250	200	1500 d.c.
TRIP relay output		1 NO-C-NC	1 NO-C-NC	2 NO-C-NC	1 NO-C-NC
Relay contact capacity				max 250 V, 5 A	
Insulation test				2.5 kV60 sec. / 4 kV imp 1.2/50 μs	
Operating temperature	[°C]			-10 ÷ 60	
Storage temperature	[°C]			-20 ÷ 70	
Relative humidity				≤ 95%	
Max terminal section	[mm ²]	4	4	2.5	4
Protection degree			IP40 front, IP20 enclosure		
Modules		3	3	6	3
Weight	[g]	200	200	500	200
Reference standards			EN 61010-1, EN 61557-8, EN 61326-1		

Command devices can be operated to command other appliances.

Families

- **E200** and **E210** switches: these devices are suitable for commanding loads and they are realized according to the EN 60947-3 and EN 60669-1 respectively.
- **ESB** and **EN** series contactors: they are devices suitable for loads to be automatically controlled through high number of operations
- **E250**, **E260** latching relays and **E259** installation relays
Their high performance in the single or multi-point control of lamps make them an ideal solution for lighting circuits.
- **AT** electro-mechanical, **D Line** and **DTS** digital and **TW** and **TWA** twilight switches:
They control circuit opening and closing according to scheduled programs (AT, D Line and DTS) or scheduled level of the ambient light (TW) or on the basis of the sun rising and setting (TWA)
- **E 232** staircase lighting time-delay switches: they are suitable to command the lighting in stairs in buildings
- **THS** modular thermostats: these devices are suitable for the majority of HVAC applications.
- **ATT** telephone actuator is suitable for remote control of electrical loads





Index

Selection tables

E 200 switches	6/2
E 463/3, E 480/3 switches.....	6/5
E 210 switches, pushbuttons and indicator lamps	6/6
SL luminous indicators for panel installation.....	6/13
ESB Installation contactors	6/15
EN 20 series contactors	6/17
ESB/EN Installation contactors	6/18
E 259 installation relays.....	6/22
E 250 latching relays	6/24
FLR latching relays.....	6/31
E 260 latching relays	6/32
STD dimmers.....	6/35
E 234 CT-D electronic timers.....	6/39
AT electro-mechanical time switches.....	6/47
D Line and DTS digital time switches.....	6/51
E 232 staircase lighting time-delay switches	6/62
TW twilight switches.....	6/65
THS modular thermostats	6/71
ATT GSM modules	6/74
CL logic relays.....	6/76



E 200 switches

Isolator for panel installation onto DIN rail acc. to DIN EN 60715

- Mounting depth: 70mm
- Mounting width: per pole = 17.5mm = 1 module
- Colour: grey, RAL 7035
- Colour of switch lever: red RAL 3000 (r); grey RAL 7000 (g)

Special features

- Fast removal without dismantling of the busbar
- Captive screws with recessed/slotted head, Pozidriv size 2
- Add-on of up to 3 auxiliary contact S2C-H6R possible
- Integrated lay-on edge for labeling system ILS
- Locking device as accessories for unauthorized ON/OFF
- Approval: VDE, CCC, KEMA

Poles	Rated voltage	Power loss	Order details	Bbn	Price	Price group	Weight	Pack
	V AC	W	Type code	Order code	EAN		kg	pc.

Rated current 16 A

1NO	230V	0.15	E201/16g	2CDE281001R1016	645614		0.095	10
1NO	230V	0.15	E201/16r	2CDE281001R0016	645621		0.095	10
2NO	400V	0.30	E202/16g	2CDE282001R1016	645799		0.190	5
2NO	400V	0.30	E202/16r	2CDE282001R0016	645805		0.190	5
3NO	400V	0.45	E203/16g	2CDE283001R1016	645973		0.290	3
3NO	400V	0.45	E203/16r	2CDE283001R0016	645980		0.290	3
4NO	400V	0.60	E204/16g	2CDE284001R1016	646154		0.390	2
4NO	400V	0.60	E204/16r	2CDE284001R0016	646161		0.390	2

Technical data

Switching capacity	1.25 x I _n ; 1.1 x U _n ; cosφ = 0.3 acc. to DIN VDE 0632 AC22-A/AC23-A acc. to VDE 0660 part 107, DIN EN 60947-3 resp. IEC 947-3, DC21-B for applications up to 60 V DC
Protection fuse	NH00 gL-gG ≤ rated current E 200
Positive opening	acc. to DIN VDE 0113
Suitable for isolation	acc. to DIN EN 60947-3
Short-circuit withstand capacity	25 kA _{eff} in series with NH 00 ≤ 100 A gL-gG; 6 kA _{eff} in series with NH 00 125 A gL-gG and S 2.. ≤63 A
Rated voltage	230/400 V AC; 50/60 Hz
Surge withstand capability U_{imp}	4 kV acc. to EN 60947-1
Ambient temperature	-25 °C to +55 °C
Storage temperature	-40 °C to +70 °C
Climatic resistance	constant climate 23/83, 40/93, 55/20 [°C/RH] alternating climate 25/95 - 40/93 [°C/RH]
Mounting position	optional
Degree of protection	IP10, IP40 in panelboard
Mechanical endurance	20000 switching cycles
Electrical endurance	1000 switching cycles
Min. voltage	12 V AC/DC at 0.1 VA
Min. contact loading	24 V/4 mA
Wire range	2.5 to 50 mm ²
Busbars	cross section ≥ 16 mm ²
Torque	2.5 Nm

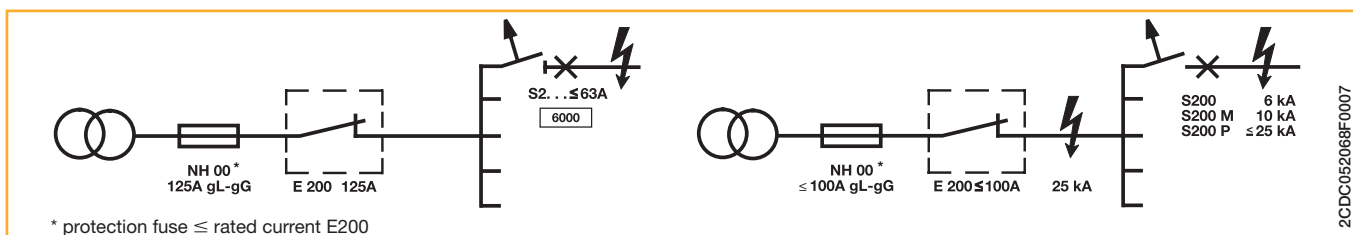

* protection fuse ≤ rated current E200



Rated current 25 A

1NO	230V	0.30	E201/25g	2CDE281001R1025	645638	0.095	10
1NO	230V	0.30	E201/25r	2CDE281001R0025	645645	0.095	10
2NO	400V	0.60	E202/25g	2CDE282001R1025	645812	0.190	5
2NO	400V	0.60	E202/25r	2CDE282001R0025	645829	0.190	5
3NO	400V	0.90	E203/25g	2CDE283001R1025	645997	0.290	3
3NO	400V	0.90	E203/25r	2CDE283001R0025	646000	0.290	3
4NO	400V	1.20	E204/25g	2CDE284001R1025	646178	0.390	2
4NO	400V	1.20	E204/25r	2CDE284001R0025	646185	0.390	2

Rated current 32 A

1NO	230V	0.50	E201/32g	2CDE281001R1032	645652	0.095	10
1NO	230V	0.50	E201/32r	2CDE281001R0032	645669	0.095	10
2NO	400V	0.95	E202/32g	2CDE282001R1032	645836	0.190	5
2NO	400V	0.95	E202/32r	2CDE282001R0032	645843	0.190	5
3NO	400V	1.40	E203/32g	2CDE283001R1032	646017	0.290	3
3NO	400V	1.40	E203/32r	2CDE283001R0032	646024	0.290	3
4NO	400V	1.90	E204/32g	2CDE284001R1032	646192	0.390	2
4NO	400V	1.90	E204/32r	2CDE284001R0032	646208	0.390	2

Rated current 40 A

1NO	230V	0.70	E201/40g	2CDE281001R1040	645676	0.095	10
1NO	230V	0.70	E201/40r	2CDE281001R0040	645683	0.095	10
2NO	400V	1.40	E202/40g	2CDE282001R1040	645850	0.190	5
2NO	400V	1.40	E202/40r	2CDE282001R0040	645867	0.190	5
3NO	400V	2.10	E203/40g	2CDE283001R1040	646031	0.290	3
3NO	400V	2.10	E203/40r	2CDE283001R0040	646048	0.290	3
4NO	400V	2.80	E204/40g	2CDE284001R1040	646215	0.390	2
4NO	400V	2.80	E204/40r	2CDE284001R0040	646222	0.390	2

Rated current 45 A

1NO	230V	0.90	E201/45g	2CDE281001R1045	645690	0.095	10
1NO	230V	0.90	E201/45r	2CDE281001R0045	645706	0.095	10
2NO	400V	1.80	E202/45g	2CDE282001R1045	645874	0.190	5
2NO	400V	1.80	E202/45r	2CDE282001R0045	645881	0.190	5
3NO	400V	2.65	E203/45g	2CDE283001R1045	646055	0.290	3
3NO	400V	2.65	E203/45r	2CDE283001R0045	646062	0.290	3
4NO	400V	3.50	E204/45g	2CDE284001R1045	646239	0.390	2
4NO	400V	3.50	E204/45r	2CDE284001R0045	646246	0.390	2

Rated current 63 A

1NO	230V	1.65	E201/63g	2CDE281001R1063	645713	0.095	10
1NO	230V	1.65	E201/63r	2CDE281001R0063	645720	0.095	10
2NO	400V	3.30	E202/63g	2CDE282001R1063	645898	0.190	5
2NO	400V	3.30	E202/63r	2CDE282001R0063	645904	0.190	5
3NO	400V	4.90	E203/63g	2CDE283001R1063	646079	0.290	3
3NO	400V	4.90	E203/63r	2CDE283001R0063	646086	0.290	3
4NO	400V	6.55	E204/63g	2CDE284001R1063	646253	0.390	2
4NO	400V	6.55	E204/63r	2CDE284001R0063	646260	0.390	2

Assembling of
S2C-H 6R and E 200

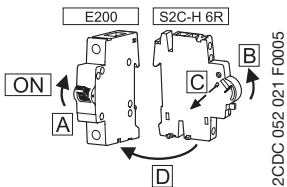

2CDC 052 021 F 0005

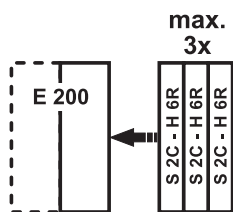

2CDC 052 022 F 0005

Rated current 80 A

1NO	230V	2.60	E201/80g	2CDE281001R1080	645737	0.095	10
1NO	230V	2.60	E201/80r	2CDE281001R0080	645744	0.095	10
2NO	400V	5.15	E202/80g	2CDE282001R1080	645911	0.190	5
2NO	400V	5.15	E202/80r	2CDE282001R0080	645928	0.190	5
3NO	400V	7.75	E203/80g	2CDE283001R1080	646093	0.290	3
3NO	400V	7.75	E203/80r	2CDE283001R0080	646109	0.290	3
4NO	400V	10.30	E204/80g	2CDE284001R1080	646277	0.390	2
4NO	400V	10.30	E204/80r	2CDE284001R0080	646284	0.390	2

Rated current 100 A

1NO	230V	3.95	E201/100g	2CDE281001R1100	645751	0.095	10
1NO	230V	3.95	E201/100r	2CDE281001R0100	645738	0.095	10
2NO	400V	7.90	E202/100g	2CDE282001R1100	645935	0.190	5
2NO	400V	7.90	E202/100r	2CDE282001R0100	645942	0.190	5
3NO	400V	11.85	E203/100g	2CDE283001R1100	646116	0.290	3
3NO	400V	11.85	E203/100r	2CDE283001R0100	646123	0.290	3
4NO	400V	15.80	E204/100g	2CDE284001R1100	646291	0.390	2
4NO	400V	15.80	E204/100r	2CDE284001R0100	646307	0.390	2

Rated current 125 A

1NO	230V	6.10	E201/125g	2CDE281001R1125	645775	0.095	10
1NO	230V	6.10	E201/125r	2CDE281001R0125	645782	0.095	10
2NO	400V	12.20	E202/125g	2CDE282001R1125	645959	0.190	5
2NO	400V	12.20	E202/125r	2CDE282001R0125	645966	0.190	5
3NO	400V	18.30	E203/125g ①	2CDE283001R1125	646130	0.33	3
3NO	400V	18.30	E203/125r ①	2CDE283001R0125	646147	0.33	3
4NO	400V	24.35	E204/125g ①	2CDE284001R1125	646314	0.44	2
4NO	400V	24.35	E204/125r ①	2CDE284001R0125	646321	0.44	2

① without approvals

E 200
DC switching capacity

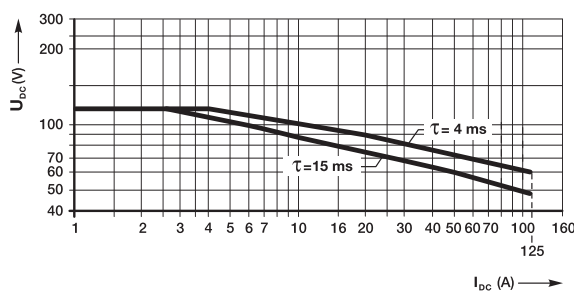

2CDC 052 131 F 0005

Terminal assignment

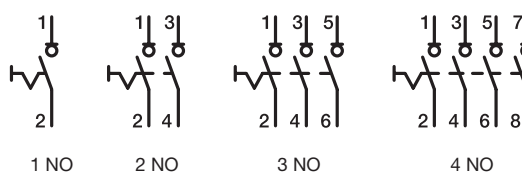

2CDC 052 171 F 0005



E 463/3-KB, E 480/3-KB, E 463/3-SL switches

Rated current A	Power loss W	Order details Type code	Order code	Bbn 7612270 EAN	Price 1 piece	Price group	Weight 1 piece kg	Pack unit pc.
63	5.4	E 463/3-KB	2CCE160300R0131	932528			0.190	1
63	5.5	E 463/3-SL	2CCE160301R0131	932535			0.195	1
80	9.9	E 480/3-KB	2CCE180300R0141	932542			0.210	1

Padlock for E 463/3-SL with 2 keys

Order details Type code	Order code	Bbn 7612270 EAN	Price 1 piece	Price group	Weight 1 piece kg	Pack unit pc.
SA 2	GJF1101903R0002	587704			0.020	1

Technical features

Switching capacity	1.25 In; 1.1 Un; cosφ = 0.6 according to DIN VDE 0632
Rated voltage	250/400 V a.c.
Connection cross section	1 mm ² stranded wire/0.5 mm ² wire up to 25 mm ²
Pick-up torque	3 Nm max.
Positive opening	according to DIN VDE 0113
Ambient temperature	-25°C to +55°C
Storage temperature	-40°C to +70°C
Poles	3 NO
Short-circuit withstanding capacity	10 kA, 400 V a.c.

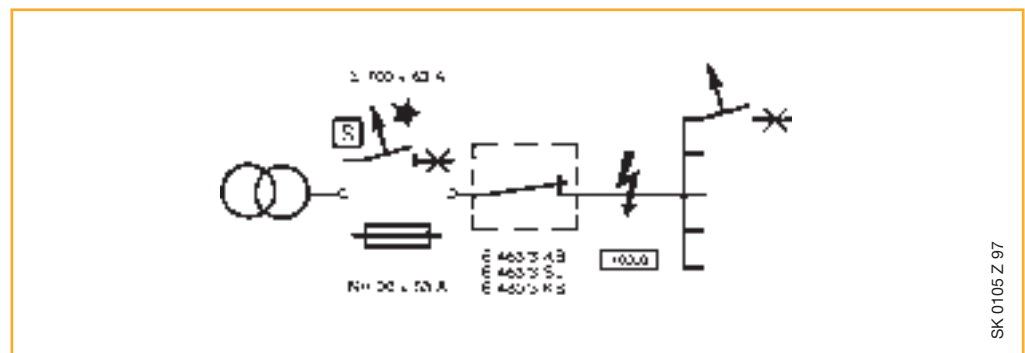

These devices are specifically made for commanding loads and signalling electrical conditions in any low-voltage switchboard. They are available in half module or 1 module, depending on the contact-layout. The devices with indicator lights are equipped with a LED, which grants an optimal illumination with very low consumption.

The functions of these devices are particularly switching, pushing and signalling electrical conditions in any installations (low-voltage area)

General new features

- Space-saving through 9mm modules
- All terminals equipped with Pozidrive 1 screws
- Safe connection due to cage-clamp
- LED with bright colours and available in three different voltage ranges
- Different lens and button colours
- Compliance to international standards

E 211-... ON-OFF switches

For example, such devices are used to switch indicators or other electrical components (like fan's, air-conditions, e.g.). The new On-Off switches distinguish themselves through simple handling, easy mounting and optimal functionality.

Contacts	Rated voltage	Power loss	Width	Order details	Bbn	Price	Price	Weight	Pack
	VAC	W	mm	Type code	Order code	EAN	EURO	kg	pc.

Rated current = 16A

1 NO	250	0.32	9	E211-16-10	2CCA703000R0001	938575		0.035	10
2 NO	230/400	0.82	9	E211-16-20	2CCA703005R0001	938582		0.045	10
3 NO	230/400	1.14	18	E211-16-30	2CCA703010R0001	938599		0.080	10
4 NO	230/400	1.64	18	E211-16-40	2CCA703015R0001	938605		0.090	10

Rated current = 25A

1 NO	250	0.75	9	E211-25-10	2CCA703001R0001	938612		0.035	10
2 NO	230/400	1.95	9	E211-25-20	2CCA703006R0001	938629		0.045	10
3 NO	230/400	2.70	18	E211-25-30	2CCA703011R0001	938636		0.080	10
4 NO	230/400	3.90	18	E211-25-40	2CCA703016R0001	938643		0.090	10

Rated current = 32A

1 NO	250	1.12	9	E211-32-10	2CCA703002R0001	938650		0.035	10
2 NO	230/400	2.73	9	E211-32-20	2CCA703007R0001	938667		0.045	10
3 NO	230/400	3.85	18	E211-32-30	2CCA703012R0001	938674		0.080	10
4 NO	230/400	5.46	18	E211-32-40	2CCA703017R0001	938681		0.090	10

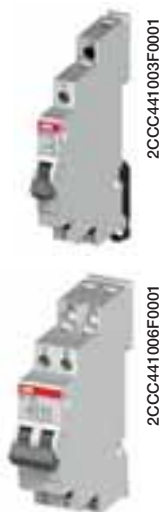

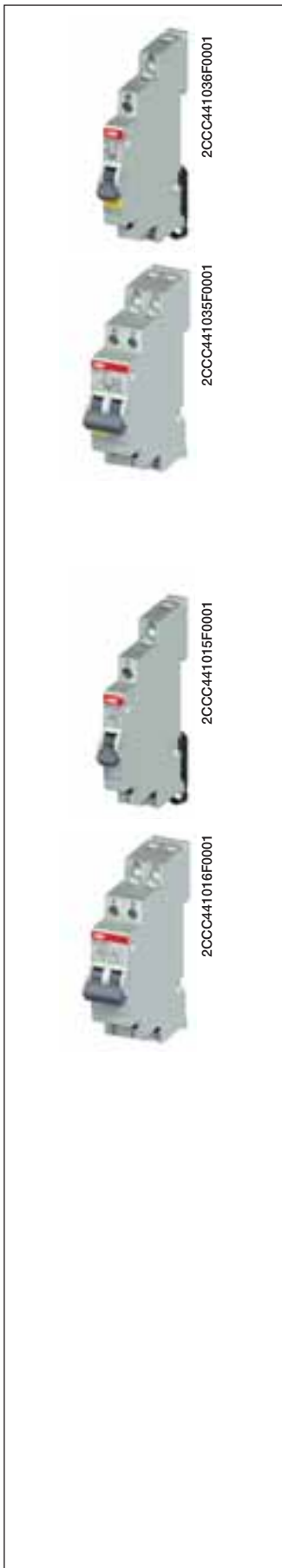

E 211X-... ON-OFF switches with yellow LED for contact indication

LED voltage 115-250 VAC

Contacts	Rated voltage	Power loss	LED colour	Width	Order details	Bbn	Price	Price	Weight	Pack
	VAC	W		mm	Type code	Order code	7612270	1 piece group	1 piece	unit
							EAN	EURO	kg	pc.

Rated current = 16A

1 NO	250	0.50	yellow	9	E211X-16-10	2CCA703100R0001	938872		0.040	10
2 NO	230/400	1.00	yellow	18	E211X-16-20	2CCA703110R0001	938889		0.050	10
3 NO	230/400	1.50	yellow	18	E211X-16-30	2CCA703115R0001	938896		0.060	10

Rated current = 25A

1 NO	250	1.15	yellow	9	E211X-25-10	2CCA703101R0001	938902		0.040	10
2 NO	230/400	2.30	yellow	18	E211X-25-20	2CCA703111R0001	938919		0.050	10
3 NO	230/400	3.45	yellow	18	E211X-25-30	2CCA703116R0001	938926		0.060	10

E 213-... Change over switches

The new change-over switches distinguish themselves through simple handling, easy mounting and optimal functionality. Example applications include opening and closing of electrically operated flaps.

Contacts	Rated voltage	Power loss	LED colour	Width	Order details	Bbn	Price	Price	Weight	Pack
	VAC	W		mm	Type code	Order code	7612270	1 piece group	1 piece	unit
							EAN	EURO	kg	pc.

Rated current = 16A

1 CO	250	0.32	-	9	E213-16-001	2CCA703040R0001	938698		0.041	10
2 CO	250	0.82	-	18	E213-16-002	2CCA703045R0001	938704		0.082	10

Rated current = 25A

1 CO	250	0.40	-	9	E213-25-001	2CCA703041R0001	938711		0.041	10
2 CO	250	0.88	-	18	E213-25-002	2CCA703046R0001	938728		0.082	10

Terminal assignment

ON / OFF switch

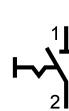

1 NO



2 NO



3 NO



4 NO

OFF switches with indicator lamps

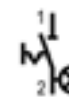

1 NO

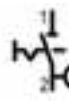

2 NO

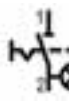

3 NO

Change-over switches



1 C/O

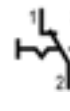

2 C/O



E 214-... Group switches (I-0-II, manual-OFF-automatic)

The new Group switches can be used to control the main installation of an emergency supply. Such devices distinguish themselves through simple handling, easy mounting and optimal functionality.

Contacts	Rated voltage	Power loss	Width	Order details	Bbn	Price	Price	Weight	Pack
	VAC	W	mm	Type code	Order code	7612270	1 piece group	1 piece	unit
						EAN	EURO	kg	pc.

Rated current = 16A

1 CO	250	0.32	9	E214-16-101	2CCA703025R0001	938735		0.041	10
2 CO	250	0.82	18	E214-16-202	2CCA703030R0001	938742		0.082	10

Rated current = 25A

1 CO	250	0.40	9	E214-25-101	2CCA703026R0001	938759		0.041	10
2 CO	250	0.88	18	E214-25-202	2CCA703031R0001	938766		0.082	10

E 218-... Control switches

These devices can be used in distribution board for any control function. The new control switches distinguish themselves through simple handling, easy mounting and optimal functionality.

Contacts	Rated voltage	Power loss	Width	Order details	Bbn	Price	Price	Weight	Pack
	VAC	W	mm	Type code	Order code	7612270	1 piece group	1 piece	unit
						EAN	EURO	kg	pc.

Rated current = 16A

1NO+1NC	250	0.50	9	E218-16-11	2CCA703050R0001	938773		0.041	10
2NO+2NC	250	1.00	18	E218-16-22	2CCA703060R0001	938780		0.082	10
3NO+1NC	250	1.50	18	E218-16-31	2CCA703065R0001	938797		0.082	10

Rated current = 25A

1NO+1NC	250	0.75	18	E218-25-11	2CCA703051R0001	938803		0.041	10
---------	-----	------	----	-------------------	-----------------	---------------	--	-------	----

Terminal assignment

Group switches

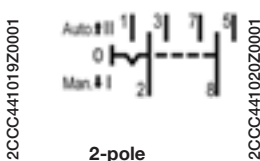
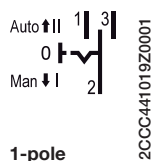

Control switches

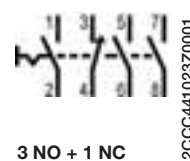
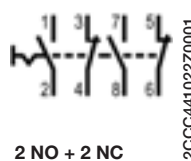
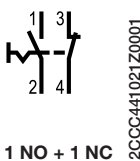

Technical features - Switches

Switching capacity		according to EN 60669-1
Isolating properties		according to EN 60669-2-4; IEC/EN 60947-3
Utilization category		AC-22A; DC-22A acc. IEC/EN60947-3
Short-circuit withstand capacity	[kA]	3
Rated voltage U_n	[V]	250/400 in accordance with EN 240 in accordance UL 508
Lowest operat. voltage		24 V; 25 mA
Rated current I_n	[A]	16, 25, 32
LED current	[mA]	5
Rated frequency	[Hz]	50/60
Modules	[No]	0.5 or 1
Sealable		in ON and OFF position
Climatic resistance		according to IEC 60068-2-2 (Dry heat) IEC 60068-2-30 (Damp heat) IEC 60068-2-1 (Cold)
Ambient temperature	[°C/°F]	-25°C/-13°F to +55°C/+131°F
Storage temperature	[°C]	-40°C to +70°C
Connection capacity	[mm ²]	from 1x1 mm ² to 1x6 mm ² or 2x2.5 mm ² massive; Flexible up 1x0.75 mm ² to 2x1.5 mm ² with connector sleeve or pin-endconnector
Tightening torque	[Nm]	1.2 - 1.5
Positive opening		according to EN 60204-1
Standards		DIN EN 60669-1 *VDE 0632-1 DIN EN 60669-2-4 *VDE 0632-2-4 UL 508
Approvals		VDE, UL, GOST, CCC

E 210 DC switching capacity

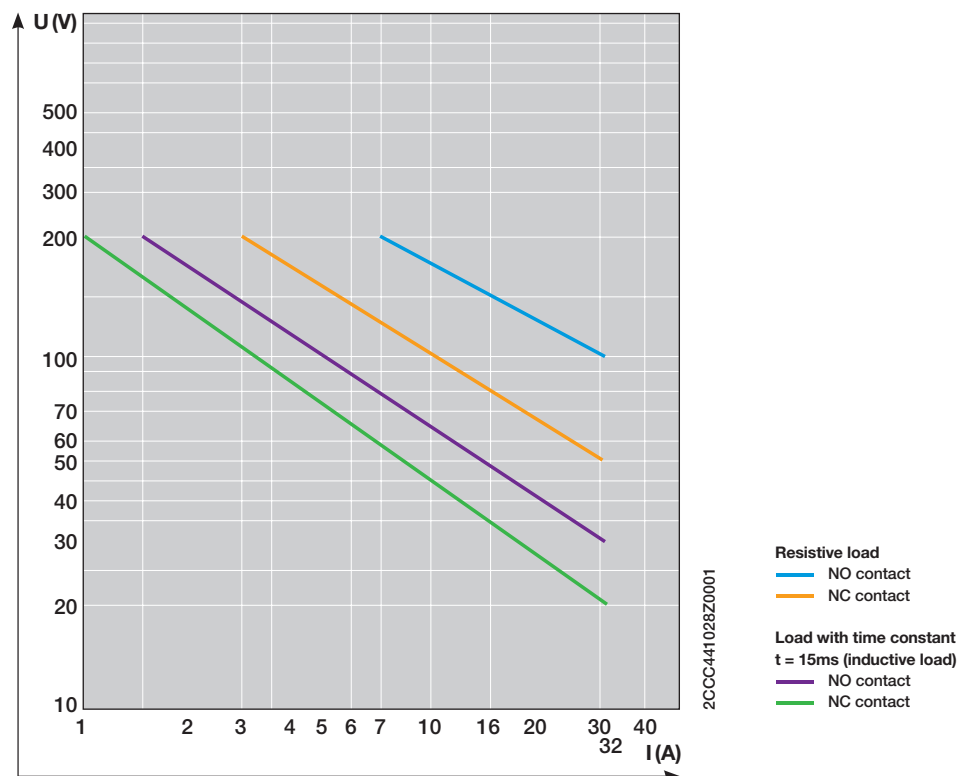



E 215-... Pushbuttons (6 different button colours)

Pushbuttons without and with LED

The new products are available in 9 mm widths (= 0.5 modules).

The devices can be used in distribution boards and are all distinguished by their simple handling, ease of mounting and optimal functionality. The pushbuttons are used for remote control in all kinds of electrical installation (e.g. public, industrial). The range offers three different voltages. (Ranges: 12-48 V AC/DC; 115-250 V AC and 110-220 V DC).

Rated current = 16A

Contacts	Rated voltage	Power loss	Button colour	Width	Order details	Bbn	Price	Price	Weight	Pack
	VAC	W		mm	Type code	Order code	7612270	1 piece	group	1 piece
							EAN	EURO	kg	pc.
1NO+1NC	250	0.50	grey	9	E215-16-11B	2CCA703150R0001	938810		0.046	10
1NO+1NC	250	0.50	red	9	E215-16-11C	2CCA703151R0001	938827		0.046	10
1NO+1NC	250	0.50	green	9	E215-16-11D	2CCA703152R0001	938834		0.046	10
1NO+1NC	250	0.50	yellow	9	E215-16-11E	2CCA703153R0001	938841		0.046	10
1NO+1NC	250	0.50	black	9	E215-16-11F	2CCA703154R0001	938858		0.046	10
1NO+1NC	250	0.50	blue	9	E215-16-11G	2CCA703155R0001	938865		0.046	10



E 217-... Luminous Pushbuttons (5 different LED colours)

Rated current = 16A

Contacts	Rated voltage	Power loss	LED colour	Width	Order details	Bbn	Price	Price	Weight	Pack
	VAC	W		mm	Type code	Order code	7612270	1 piece	group	1 piece
							EAN	EURO	kg	pc.
1 NO	250	1.10	white	9	E217-16-10B	2CCA703160R0001	938988		0.050	10
1 NO	250	1.10	red	9	E217-16-10C	2CCA703161R0001	938995		0.050	10
1 NO	250	1.10	green	9	E217-16-10D	2CCA703162R0001	939008		0.050	10
1 NO	250	1.10	yellow	9	E217-16-10E	2CCA703163R0001	939015		0.050	10
1 NO	250	1.10	blue	9	E217-16-10G	2CCA703164R0001	939022		0.050	10

LED Voltage range = 115-250VAC

1 NC	250	1.10	white	9	E217-16-01B	2CCA703250R0001	939084		0.050	10
1 NC	250	1.10	red	9	E217-16-01C	2CCA703251R0001	939091		0.050	10
1 NC	250	1.10	green	9	E217-16-01D	2CCA703252R0001	939107		0.050	10
1 NC	250	1.10	yellow	9	E217-16-01E	2CCA703253R0001	939114		0.050	10
1 NC	250	1.10	blue	9	E217-16-01G	2CCA703254R0001	939121		0.050	10



2CCA441048F0001

E 217-... Luminous Pushbuttons (5 different LED colours)

Rated current = 16A

Contacts	Rated voltage	Power loss	LED colour	Width	Order details	Bbn	Price	Price	Weight	Pack
	VAC	W		mm	Type code	Order code	7612270	1 piece group	1 piece	unit
							EAN	EURO	kg	pc.

LED Voltage range = 12-48VAC/DC

1 NO	250	0.72	white	9	E217-16-10B48	2CCA703170R0001	938933		0.050	10
1 NO	250	0.72	red	9	E217-16-10C48	2CCA703171R0001	938940		0.050	10
1 NO	250	0.72	green	9	E217-16-10D48	2CCA703172R0001	938957		0.050	10
1 NO	250	0.72	yellow	9	E217-16-10E48	2CCA703173R0001	938964		0.050	10
1 NO	250	0.72	blue	9	E217-16-10G48	2CCA703174R0001	938971		0.050	10

1 NC	250	0.72	white	9	E217-16-01B48	2CCA703260R0001	939039		0.050	10
1 NC	250	0.72	red	9	E217-16-01C48	2CCA703261R0001	939046		0.050	10
1 NC	250	0.72	green	9	E217-16-01D48	2CCA703262R0001	939053		0.050	10
1 NC	250	0.72	yellow	9	E217-16-01E48	2CCA703263R0001	939060		0.050	10
1 NC	250	0.72	blue	9	E217-16-01G48	2CCA703264R0001	939077		0.050	10

LED Voltage range = 110-220VDC

1 NO	250	1.50	white	9	E217-16-10B220	2CCA703165R0001	939138		0.050	10
1 NO	250	1.50	red	9	E217-16-10C220	2CCA703166R0001	939145		0.050	10
1 NO	250	1.50	green	9	E217-16-10D220	2CCA703167R0001	939152		0.050	10
1 NO	250	1.50	yellow	9	E217-16-10E220	2CCA703168R0001	939169		0.050	10
1 NO	250	1.50	blue	9	E217-16-10G220	2CCA703169R0001	939176		0.050	10

1 NC	250	1.50	white	9	E217-16-01B220	2CCA703255R0001	939183		0.050	10
1 NC	250	1.50	red	9	E217-16-01C220	2CCA703256R0001	939190		0.050	10
1 NC	250	1.50	green	9	E217-16-01D220	2CCA703257R0001	939206		0.050	10
1 NC	250	1.50	yellow	9	E217-16-01E220	2CCA703258R0001	939213		0.050	10
1 NC	250	1.50	blue	9	E217-16-01G220	2CCA703259R0001	939220		0.050	10

E 219-... Indicator Lights with LED (5 different colours)

Indicator Lights with LED

The new products are available in 9 mm width (= 0.5 modules) and can be used for indicating any operational condition such as signalling loss of a phase.

The range offers three different voltages.

(Ranges: 12-48 V AC/DC; 115-250 V AC and 110-220 V DC).

LED colour	Power loss	Width	Order details	Bbn	Price	Price	Weight	Pack
	W	mm	Type code	Order code	7612270	1 piece group	1 piece	unit
					EAN	EURO	kg	pc.

LED Voltage range = 115-250VAC

white	0.47	9	E219-B	2CCA703400R0001	939282		0.04	10
red	0.47	9	E219-C	2CCA703401R0001	939299		0.04	10
green	0.47	9	E219-D	2CCA703402R0001	939305		0.04	10
yellow	0.47	9	E219-E	2CCA703403R0001	939312		0.04	10
blue	0.47	9	E219-G	2CCA703404R0001	939329		0.04	10



2CCA441075F0001

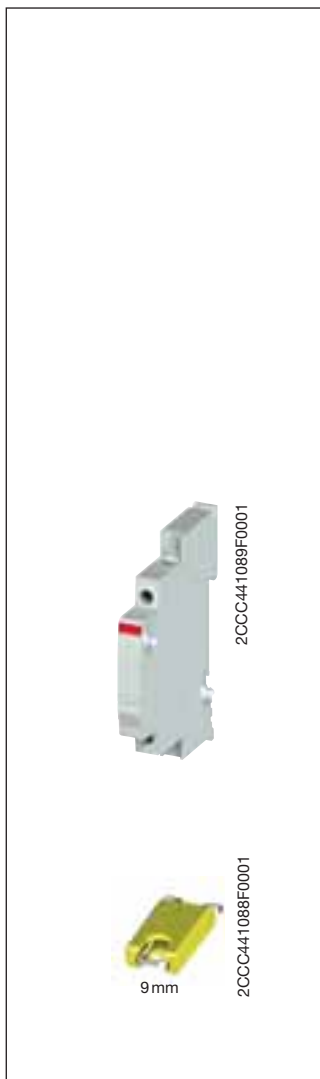

LED Voltage range = 12-48VAC/DC

white	0.40	9	E219-B48	2CCA703420R0001	939237	0.04	10
red	0.40	9	E219-C48	2CCA703421R0001	939244	0.04	10
green	0.40	9	E219-D48	2CCA703422R0001	939251	0.04	10
yellow	0.40	9	E219-E48	2CCA703423R0001	939268	0.04	10
blue	0.40	9	E219-G48	2CCA703424R0001	939275	0.04	10

LED Voltage range = 110-220VDC

white	1.00	9	E219-B220	2CCA703405R0001	939336	0.04	10
red	1.00	9	E219-C220	2CCA703406R0001	939343	0.04	10
green	1.00	9	E219-D220	2CCA703407R0001	939350	0.04	10
yellow	1.00	9	E219-E220	2CCA703408R0001	939367	0.04	10
blue	1.00	9	E219-G220	2CCA703409R0001	939374	0.04	10

Accessories for E 210 device series

Order details	Bbn	Price	Price	Weight	Pack
Type code	Order code	EAN	EURO	kg	pc.

Dummy housing for 9 mm wide units

The modular width of 18 mm must be complied with to use the devices in the SMISLINE socket system. The dummy housing is ready-made with two expanding connectors. Always snap on dummy housing on the left.

E210-DH	2CCA703480R0001	404208	0.18	10
----------------	-----------------	---------------	------	----

Padlock

to use for 9 and 18 mm wide units	E210-ASV9	2CCA703648R0001	404215	10
-----------------------------------	------------------	-----------------	---------------	----

Technical features - Pushbuttons and Indicator Lights

Rated Voltage U_n	[V]	250/400
Lowest operat. voltage		24 V; 25 mA
Rated current I_n	[A]	16
LED current	[mA]	5
Rated frequency	[Hz]	50/60
Modules	[No]	0.5
Tightening torque	[Nm]	1.2 - 1.5
Standards		EN 60669-1; EN 62094-1; UL 508
Approvals		Pushbuttons: VDE, UL, GOST, CCC Indicator lights: VDE, UL, GOST

Terminal assignment

Pushbutton

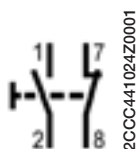

Luminous Pushbutton

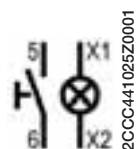

Indicator Light

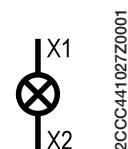

Luminous indicators for panel installation

Luminous indicator

These luminous indicator devices provide an intuitive and readily visible front panel display of the state of an electrical line or load situated either remotely or inside the panel itself. The range of luminous indicator includes devices with 3, 4 or 12 LEDs with various supply voltage ratings, and fully-customisable plain labels.

The version with 115 V d.c. supply rating, is ideal for installation on medium voltage panels and for non-standard applications, and complete an extensive range of easy-to-install indicator devices.



2CSC445165F0001

Size mm	Number of LEDs	Characteristics of the LEDs	Label	Order details Type code	Order code	Bbn 801254 EAN	Price 1 piece	Price group	Weight 1 piece kg	Pack unit pc.
------------	-------------------	--------------------------------	-------	-------------------------------	------------	----------------------	------------------	----------------	-------------------------	---------------------

Indicator lamps 24 V a.c./d.c.

48	3	not included	neutral	SL-3-24V/48	2CSG211010R3001	2659501			0.01	1
48	4	not included	neutral	SL-4-24V/48	2CSG221010R3001	2659600			0.01	1
48	3		neutral	SL-3-L1-L2-L3-24V/48	2CSG241020R3001	2659709			0.01	1
48	3		in English	SL-3-A-C-S-24V/48	2CSG251030R3001	2659808			0.01	1
48	4		in English	SL-3-A-C-S-E-24V/48	2CSG251040R3001	2659907			0.01	1

Indicator lamps 48 V a.c./d.c.

48	3	not included	neutral	SL-3-48V/48	2CSG311010R3001	2660002			0.01	1
48	4	not included	neutral	SL-4-48V/48	2CSG321010R3001	2658603			0.01	1
48	3		neutral	SL-3-L1-L2-L3-48V/48	2CSG341020R3001	2658702			0.01	1
48	3		in English	SL-3-A-C-S-48V/48	2CSG351030R3001	2658801			0.01	1
48	4		in English	SL-3-A-C-S-E-48V/48	2CSG351040R3001	2658900			0.01	1

Indicator lamps 115 V a.c.

48	3	not included	neutral	SL-3-115V/48	2CSG411010R3001	2659006			0.01	1
48	4	not included	neutral	SL-4-115V/48	2CSG421010R3001	2659105			0.01	1
48	3		in English	SL-3-A-C-S-115V/48	2CSG451030R3001	2659303			0.01	1
48	4		in English	SL-4-A-C-S-E-115V/48	2CSG451040R3001	2659402			0.01	1

Indicator lamps 115 V d.c.

48	3	not included	neutral	SL-3-115V/48 DC	2CSG273233R3001	2659006			0.01	1
48	4	not included	neutral	SL-4-115V/48 DC	2CSG273313R3001	2659105			0.01	1
48	3		in English	SL-3-A-C-S-115V/48 DC	2CSG273223R3001	2659303			0.01	1
48	4		in English	SL-4-A-C-S-E-115V/48 DC	2CSG273303R3001	2659402			0.01	1
96	12	not included	neutral	SL12-115V/96 DC	2CSG273213R3001	2732136			0.01	1
144	12	not included	neutral	SL12-115V/72-144 DC	2CSG273293R3001	2732938			0.01	1

Wiring diagram

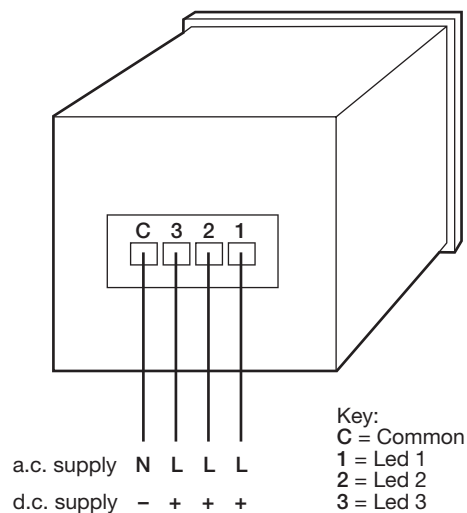

1CSC400060F0202



2CSC445169F0001

Panel dimens. mm	Number of LEDs	Characteristics of the LEDs	Label	Order details Type code	Order code	Bbn 801254 EAN	Price 1 piece	Price group	Weight 1 piece kg	Pack unit pc.
------------------------	-------------------	--------------------------------	-------	-------------------------------	------------	----------------------	------------------	----------------	-------------------------	---------------------

Luminous indicators 230 V a.c.

48	3	not included	neutral	SL-3-230V/48	2CSG511010R3001	2659501			0.01	1
48	4	not included	neutral	SL-4-230V/48	2CSG521010R3001	2659600			0.01	1
48	3	■	neutral	SL-3-L1-L2-L3-230V/48	2CSG541020R3001	2659709			0.01	1
48	3	■ ■ ■	in English	SL-3-A-C-S-230V/48	2CSG551030R3001	2659808			0.01	1
48	4	■ ■ ■ ■	in English	SL-3-A-C-S-E-230V/48	2CSG551040R3001	2659907			0.01	1
96	12	not included	alarm	SL-12-24V/96	2CSG274050R3001	2660002			0.03	1
96	12	not included	alarm	SL-12-48V/96	2CSG374050R3001	2660101			0.03	1
96	12	not included	alarm	SL-12-115V/96	2CSG474050R3001	2660200			0.03	1
96	12	not included	alarm	SL-12-230V/96	2CSG574050R3001	2660309			0.03	1
144	12	not included	alarm	SL-12-24V/144	2CSG233050R3001	2660408			0.35	1
144	12	not included	alarm	SL-12-48V/144	2CSG333050R3001	2660507			0.35	1
144	12	not included	alarm	SL-12-115V/144	2CSG433050R3001	2660606			0.35	1
144	12	not included	alarm	SL-12-230V/144	2CSG533050R3001	2660705			0.35	1

Accessories for luminous indicators

■ red LED	2CSG500060R3001	2660804	0.05	5 pcs
■ green LED	2CSG500070R3001	2660903	0.05	5 pcs
■ yellow LED	2CSG500080R3001	2661009	0.05	5 pcs
■ blue LED	2CSG500090R3001	2661108	0.05	5 pcs
□ white LED	2CSG500100R3001	2661207	0.05	5 pcs

Technical characteristics

Electrical characteristics

Supply	[V]	- a.c./d.c 24, 48 - a.c. 115, 230 - d.c. 115
Frequency	[Hz]	0-1000
Power consumption	[W]	0.5 max per input
TEST input consumption	[W]	4 max
Other characteristics		
Operating temperature	[°C]	-20 +60
Storage temperature	[°C]	-20 +70
Relative humidity		30-95%
Overall dimensions	[mm]	48 x 48 x 56 (SL-3 e SL-4) 96 x 96 x 56 (SL...96) 72 x 144 x 70 (SL...72-144)
Weight	[gr]	100 (SL-3 e SL-4), 300 (SL-12-115V/96) 350 (SL-12-115V/72-144)
Protection degree		IP40
Label dimensions	[mm]	30 x 9

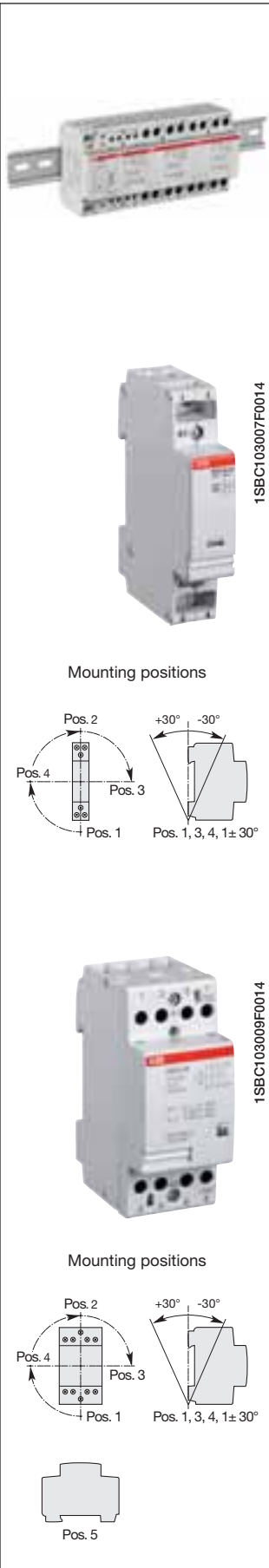

Application

The ESB contactors are used mainly in buildings for switching and controlling lighting, heating, ventilation and pumps. They are part of the complete range of Din rail products and can be integrated easily in dedicated panels.

ESB20 are AC coil operated.

The **ESB 24, 40, 63** contactors are used for the control of loads up to 24, 40, 63 A. Due to their DC solenoid actuator, the ESB 24 can be connected to AC or DC voltages. This provides the following benefits:

Hum-free operating system, no vibration, silent in operation, low power consumption, integrated high overvoltage protection 5 kV. You can choose between a various N.O. and N.C. contacts combination.

Main accessories für ESB 24, 40, 63
Auxiliary contact blocks **EH04**.

Certifications and Approvals



Ordering Details ESB 20

Main poles	Nb of modules	Control coil voltage		Order details		bbn 3471521 EAN	Price 1 piece	Price group	Weight 1 piece kg	Pack unit pc.
		50 Hz	60 Hz	Type code	Order code					
2 N.O. 	1	12 V	14 V	ESB 20-20	GHE 321 1102 R1004	1230141			0.14	10
		24 V	28 V	ESB 20-20	GHE 321 1102 R0001	0263218			0.14	10
		110 V	125...127 V	ESB 20-20	GHE 321 1102 R0004	1230042			0.14	10
		230 V	264 V	ESB 20-20	GHE 321 1102 R0006	0263263			0.14	10
2 N.C. 	1	12 V	14 V	ESB 20-02	GHE 321 1202 R1004	1232145			0.14	10
		24 V	28 V	ESB 20-02	GHE 321 1202 R0001	0263812			0.14	10
		110 V	125...127 V	ESB 20-02	GHE 321 1202 R0004	1232046			0.14	10
		230 V	264 V	ESB 20-02	GHE 321 1202 R0006	0263867			0.14	10
1 N.O. 1 N.C. 	1	12 V	14 V	ESB 20-11	GHE 321 1302 R1004	1231148			0.14	10
		24 V	28 V	ESB 20-11	GHE 321 1302 R0001	0263515			0.14	10
		110 V	125...127 V	ESB 20-11	GHE 321 1302 R0004	1231049			0.14	10
		230 V	264 V	ESB 20-11	GHE 321 1302 R0006	0263560			0.14	10

Ordering Details ESB 24

Main poles	Nb of modules	Control coil voltage		Order details		bbn 4013614 EAN	Price 1 piece	Price group	Weight 1 piece kg	Pack unit pc.
		40...450 Hz	DC	Type code	Order code					
2 N.O. 	2	230...240 V	230...240 V	ESB 24-20	GHE 329 1402 R0006	146756			0.28	5
2 N.O. 	2	12 V	12 V	ESB 24-20	GHE 329 1402 R0001	215193			0.28	5
4 N.O. 	2	12 V	12 V	ESB 24-40	GHE 329 1102 R1004	084478			0.28	5
		24 V	24 V	ESB 24-40	GHE 329 1102 R0001	084416			0.28	5
		110...120 V	110...120 V	ESB 24-40	GHE 329 1102 R0004	084430			0.28	5
		230...240 V	230...240 V	ESB 24-40	GHE 329 1102 R0006	084454			0.28	5
4 N.C. 	2	12 V	12 V	ESB 24-04	GHE 329 1202 R1004	084560			0.28	5
		24 V	24 V	ESB 24-04	GHE 329 1202 R0001	084515			0.28	5
		110...120 V	110...120 V	ESB 24-04	GHE 329 1202 R0004	084539			0.28	5
		230...240 V	230...240 V	ESB 24-04	GHE 329 1202 R0006	084546			0.28	5
2 N.O. 2 N.C. 	2	12 V	12 V	ESB 24-22	GHE 329 1302 R1004	084638			0.28	5
		24 V	24 V	ESB 24-22	GHE 329 1302 R0001	084584			0.28	5
		110...120 V	110...120 V	ESB 24-22	GHE 329 1302 R0004	084607			0.28	5
		230...240 V	230...240 V	ESB 24-22	GHE 329 1302 R0006	084614			0.28	5
3 N.O. 1 N.C. 	2	12 V	12 V	ESB 24-31	GHE 329 1602 R1004	084720			0.28	5
		24 V	24 V	ESB 24-31	GHE 329 1602 R0001	084676			0.28	5
		110...120 V	110...120 V	ESB 24-31	GHE 329 1602 R0004	084690			0.28	5
		230...240 V	230...240 V	ESB 24-31	GHE 329 1602 R0006	084706			0.28	5
1 N.O. 3 N.C. 	2	12 V	12 V	ESB 24-13	GHE 329 1702 R1004	218255			0.28	5
		24 V	24 V	ESB 24-13	GHE 329 1702 R0001	214783			0.28	5
		110...120 V	110...120 V	ESB 24-13	GHE 329 1702 R0004	218224			0.28	5
		230...240 V	230...240 V	ESB 24-13	GHE 329 1702 R0006	218224			0.28	5



Ordering Details ESB 40

Main poles	Nb of modules	Control coil voltage 40...450 Hz DC		Order details		bbn 4013614 EAN	Price 1 piece	Price group	Weight 1 piece kg	Pack unit pc.
				Type code	Order code					
4 N.O. 	3	12 V	12 V	ESB 40-40	GHE 349 1102 R1004	149245			0.40	3
				ESB 40-40	GHE 349 1102 R0001	084829		0.40	3	
				ESB 40-40	GHE 349 1102 R0004	084843		0.40	3	
				ESB 40-40	GHE 349 1102 R0006	084867		0.40	3	
2 N.O. 2 N.C. 	3	24 V	24 V	ESB 40-22	GHE 349 1302 R0001	379611			0.40	3
				ESB 40-22	GHE 349 1302 R0006	214332		0.40	3	
3 N.O. 1 N.C. 	3	24 V	24 V	ESB 40-31	GHE 349 1602 R0001	316890			0.40	3
				ESB 40-31	GHE 349 1602 R0006	214349		0.40	3	
3 N.O. 	3	24 V	24 V	ESB 40-30	GHE 349 1502 R0001	316890			0.39	3
				ESB 40-30	GHE 349 1502 R0006	214349		0.39	3	
2 N.O. 	3	24 V	24 V	ESB 40-20	GHE 349 1402 R0001	212345			0.38	3
				ESB 40-20	GHE 349 1402 R0006	085314		0.38	3	

Ordering Details ESB 63

Main poles	Nb of modules	Control coil voltage 40...450 Hz DC		Order details		bbn 4013614 EAN	Price 1 piece	Price group	Weight 1 piece kg	Pack unit pc.
				Type code	Order code					
4 N.O. 	3	12 V	12 V	ESB 63-40	GHE 369 1102 R1004	218262			0.42	3
				ESB 63-40	GHE 369 1102 R0001	084935		0.42	3	
				ESB 63-40	GHE 369 1102 R0004	084959		0.42	3	
				ESB 63-40	GHE 369 1102 R0006	084973		0.42	3	
3 N.O. 1 N.C. 	3	110 V	110 V	ESB 63-31	GHE 369 1602 R0004	???			0.42	3
				ESB 63-31	GHE 369 1602 R0006	???		0.42	3	
3 N.O. 	3	230 V	230 V	ESB 63-30	GHE 369 1502 R0006	085376			0.41	3
				ESB 63-30	GHE 369 1502 R0007	260964		0.41	3	
2 N.O. 	3	24 V	24 V	ESB 63-20	GHE 369 1402 R0001	291999			0.40	3
				ESB 63-20	GHE 369 1402 R0006	085369		0.40	3	
1 N.O. 1 N.C. 	3	230 V	230 V	ESB 63-11	GHE 369 1802 R0006	214622			0.40	3



1SBC103001F0014

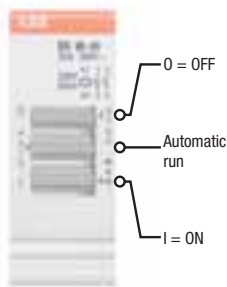

1CSC400063F0202

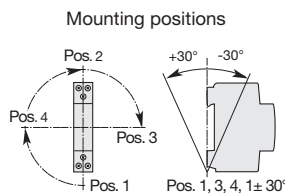

Application

The EN contactors are used mainly in buildings for switching and controlling lighting, heating, ventilation and pumps. They are part of the complete range of Din rail products and can be integrated easily in dedicated panels.

Description

EN contactors have a built-in toggle switch to select between three function modes:

Off position, automatic run (normal contactor function), manual override with a return to Auto the next time the coil is energized.

This offers many advantages as:

You can make functional test before installation start-up. It can be used for maintenance operation, to change lamps and test it. It provides higher safety and drop out as you can switch the application manually.

The toggle switch is also used for household application like water heating where double tariff of kWh is used.

Certifications and Approvals



Ordering Details

Main poles	Nb of modules	Control coil voltage	Order details	bbn	Price	Price	Weight	Pack
		50 Hz 60 Hz	Type code Order code	4013614	1 piece	group	1 piece	unit
				EAN			kg	pc.
2 N.O.	1	24 V 28 V	EN 20-20 GHE 322 1101 R0001	239038			0.14	10
		230 V 264 V	EN 20-20 GHE 322 1101 R0006	265069			0.14	10

Ordering Details

Main poles	Nb of modules	Control coil voltage	Order details	bbn	Price	Price	Weight	Pack
		40...450 Hz DC	Type code Order code	4013614	1 piece	group	1 piece	unit
				EAN			kg	pc.
2 N.O.	3	230...240 V 230...240 V	EN 40-20 GHE 342 1401 R0006	129582			0.40	3
4 N.O.	2	24 V 24 V	EN 24-40 GHE 326 1101 R0001	190469			0.24	5
		230...240 V 230...240 V	EN 24-40 GHE 326 1101 R0006	133688			0.24	5
3 N.O. 1 N.C.	2	24 V 24 V	EN 24-31 GHE 326 1601 R0001	316906			0.24	5
		230...240 V 230...240 V	EN 24-31 GHE 326 1601 R0006	133695			0.24	5
3 N.O.	2	230...240 V 230...240 V	EN 24-30 GHE 326 1501 R0006	134319			0.23	5

Ordering Details

Main poles	Nb of modules	Control coil voltage	Order details	bbn	Price	Price	Weight	Pack
		40...450 Hz DC	Type code Order code	4013614	1 piece	group	1 piece	unit
				EAN			kg	pc.
4 N.O.	3	24 V 24 V	EN 40-40 GHE 342 1101 R0001	262500			0.41	3
		110 V 110 V	EN 40-40 GHE 342 1101 R0004	261077			0.41	3
		230...240 V 230...240 V	EN 40-40 GHE 342 1101 R0006	133701			0.41	3
3 N.O. 1 N.C.	3	24 V 24 V	EN 40-31 GHE 342 1601 R0001	337017			0.41	3
		230...240 V 230...240 V	EN 40-31 GHE 342 1601 R0006	337017			0.41	3
3 N.O.	3	230...240 V 230...240 V	EN 40-30 GHE 342 1501 R0006	212338			0.40	3



1SBC103015F0014

EH 04-20

Contact Blocks

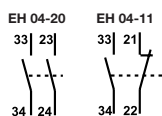

ESB-PLK 24

1SBC103012F0014



ESB-PLK 40/63



ESB-DIS

1SBC103011F0014

Ordering Details

Contactor Type	Contact blocks	Order details		bbn 4013614 EAN	Price 1 piece	Price group	Weight 1 piece kg	Pack unit pc.
		Type code	Order code					
ESB/EN 24, 40, 63	2 -	EH 04-20	GHE 340 1321 R0001	084768			0.004	10
	1 1	EH 04-11	GHE 340 1321 R0002	084768			0.004	10

Sealing cover

Contactor Type	Order details		bbn 4013614 EAN	Price 1 piece	Price group	Weight 1 piece kg	Pack unit pc.
	Type code	Order code					
ESB/EN 24	ESB-PLK 24	GHE 320 1903 R0001	084171			0.002	10
ESB/EN 40,63	ESB-PLK 40/63	GHE 340 1903 R0002	085222			0.002	10

Distance piece

Contactor Type	Order details		bbn 4013614 EAN	Price 1 piece	Price group	Weight 1 piece kg	Pack unit pc.
	Type code	Order code					
ESB/EN 24, 40,63	ESB-DIS	GHE 340 1902 R0001	085215			0.002	10

Sealing cover



Auxiliary Contact Blocks

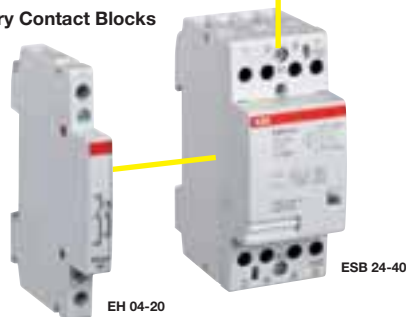

1SBC103009F0014

Main Pole - Utilization Characteristics according to IEC

Contactor types:	AC operated AC/DC operated	ESB20/EN20				ESB24/EN24		ESB40/EN40		ESB63	
Rated operational voltage U_e max.	V	250		400							
Rated frequency limits	Hz	50/60		40...450							
Utilization category AC-1 / AC-7a											
for air temperature close to contactor $< 55\text{ °C}$	(NO) A	20		24		40		63			
Max. rated operational current I_e AC-1 / AC-7a	(NC) A	20		24		30		30			
Rated operational power AC-1											
230 V - 1 phase	kW	4		5.3		8.8		13.8			
400 V - 3 phases	kW	-		16		26		41			
Utilization category AC-3 / AC-7b											
for air temperature close to contactor $\leq 55\text{ °C}$											
Max. rated operational current I_e AC-3/AC-7b											
230 V - 1 phase	A	9		9		22		30			
400 V - 3 phases	A	-		9		22		30			
Rated operational power AC-3											
230 V - 1 phase	kW	1.1		2.2		5.5		8			
400 V - 3 phases	kW	-		4		11		15			
Rated making capacity AC-3											
Rated breaking capacity AC-3											
		$10 \times I_e / \text{AC-3}$		$10 \times I_e / \text{AC-3}$		$10 \times I_e / \text{AC-3}$		$10 \times I_e / \text{AC-3}$			
		$8 \times I_e / \text{AC-3}$		$8 \times I_e / \text{AC-3}$		$8 \times I_e / \text{AC-3}$		$8 \times I_e / \text{AC-3}$			
Short-circuit protection for contactors											
gG type fuse	A	20		35		63		80			
Rated short-time withstand current I_{cw}											
at 40 °C ambient temp.,											
in free air, from a cold state	10 s A	72				176		240			
Heat dissipation per pole $I_e / \text{AC-1/AC-7a}$	W	1		1.5		3		6			
Max. electrical switching frequency											
- for AC-1 / AC-7a	cycles/h	300									
- for AC-3 / AC-7b	cycles/h	600									
Electrical durability											
- for AC-1 / AC-7a	cycles	150000		150000		150000		150000			
- for AC-3 / AC-7b	cycles	150000		500000		170000		240000			
Mechanical durability											
- millions of operating cycles		1.000.000									

Magnet System Characteristics

Contactor types:	AC operated AC/DC operated	ESB20		ESB24		ESB40		ESB63	
Coil operating limits acc. to IEC 60947-4-1		0.85 ... 1.1 x U_e (at $\theta \leq 55\text{ °C}$)							
Drop-out voltage in % of U_e		approx. 20 ... 75 %		approx. 20 ... 70 %					
Frequency range	Hz	50/60		40 ... 450					
Coil consumption									
Average pull-in value	VA/W	8 / 5		4 / 4		5 / 5		65 / 65	
Average holding value	VA/W	3.2 / 1.2		4 / 4		5 / 5		4.2 / 4.2	

Connecting Characteristics

Contactor types:	AC operated AC/DC operated	ESB20		ESB40	
Connecting capacity (min. ... max.)					
Main pole terminals					
Rigid	1 x mm²	1.5 ... 10		1.5 ... 25	
	2 x mm²	1.5 ... 4		1.5 ... 10	
Degree of protection					
acc. to IEC 60947-1 / EN 60947-1 and IEC 60529 / EN 60529					
Protection against direct contact in acc. with EN 50274					
All terminals		IP20			

EH04... Auxiliary Contact Block - Utilization Characteristics according to IEC

Contactor types:	AC operated AC/DC operated	ESB20	ESB24	ESB40	ESB63
Rated operational voltage U_g max.	V	-	500		
Conventional free air thermal current I_{th} $\theta \leq 40$ °C	A	-	6		
Rated frequency limits	Hz	-	50/60		
Rated operational current I_e / AC-15 acc. to IEC 60947-5-1					
240 V 50/60 Hz	A	-	4		
415 V 50/60 Hz	A	-	3		
500 V 50/60 Hz	A	-	2		
Making capacity acc. to IEC 60947-5-1		-	11 x I_e AC-15		
Breaking capacity acc. to IEC 60947-5-1		-	11 x I_e AC-15		
Short-circuit protection gl type fuse	A	-	10		
Minimum switching capacity with failure rate acc. to IEC 60947-5-4	V/mA	-	17 / 5		
Heat dissipation per pole at 6 A	W	-	0.1		

Electrical durability

AC-1 / 400 V / 3-phase for ESB 20, 24, 40, 63

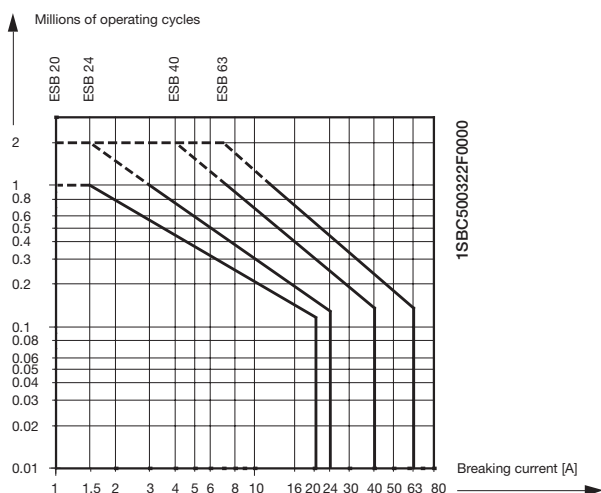

AC-3 / 400 V / 3-phase for ESB 24, 40, 63

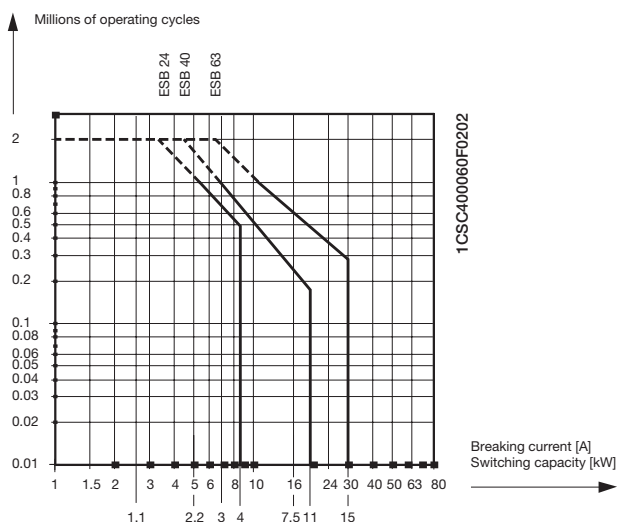

	Latching relays E250		Installation relays E259
	Contacts switching on each impulse sent to the control coil.		Contacts maintained in switched position only while the control coil is supplied.
General characteristics			
Type of command	Impulse (i.e. via pushbutton)		Continuous (i.e. via switch)
Energy consumption of command circuit	Only on pickup		For entire time contact switching is maintained
Local control lever	Yes		Yes, temporary
Main application	Lighting command by pushbuttons		Lighting command by switches, thermostats, time switches
Rated current	16 A	32 A	16 A
Single phase lamps load characteristics ①			
Incandescent and halogen	3000 W	4000 W	1800 W
Fluorescent power factor corrected in series	3000 VA	4000 VA	1800 VA
Fluorescent power factor corrected in parallel	2500 VA	3200 VA	500 VA
Fluorescent uncorrected power factor	1800 VA	2200 VA	900 VA
Power contacts			
1NA	■	■	■
2NA	■	■	■
Sequential	■		
1NA+1NC	■		■
2NA+2NC	with E250CM11		
3NA, 4NA	with E250CM20	with E250-32 CM20	■
1C/O, 2C/O	■		■
3C/O, 4C/O	with E250CM002		■

① See technical details for information on each lamp type

Accessories for E250 series latching relays

Auxiliary contacts
max. two per relay without other accessories

Auxiliary contact
max one if the relay is coupled with other accessories

Central command
max one per relay

Power contact
max one per relay

Accessories of E257C and E258C series latching relays

Auxiliary contacts
max one for E257 with two or more contacts and for E258 relays

Auxiliary contacts
max two for E257 relay with single contact

Accessories for E259 installation relays

Auxiliary contacts
max one for E259 relay with 3 or 4 contacts

Auxiliary contacts
max two for E259 relay with 1 or 2 contacts

Other accessories for E250 series latching relays

These accessories do not require any mechanical connection and can be used with all the latching relays.

Compensator module
To be connected in parallel with the command circuit if using illuminated pushbuttons with two terminals. See table for max. number of installable pushbuttons in technical details.

E250CP

Group module
Can be connected to the central command circuit to create subgroups of relays. Suitable only for use with E257 and E258 devices, or with E250 equipped with the E257 CM accessory. See specific connection diagram.

E250GM



E 259 installation relays

E 259 Installation relays are 16 A contactors specifically engineered for residential and commercial applications. Their high performance in the control of lamps makes them ideal for lighting circuit applications.

The front control lever indicates the position of the contacts and allows the relay to be commanded, for example for local testing of the circuit.

In installations that require several E 259 relays side by side, it is advisable to use E 259 DIS half-module width spacer elements every second relay for heat dissipation.

E 259, 16 A

Contacts	Coil voltage	Order details		Bbn	Price 1 piece	Price group	Weight 1 piece kg	Pack unit pc.
		Type code	Order code	8012542 EAN				
1NO	8 V a.c.	E259 16-10/8	2CSM261123R0401	611233			0.100	12
	12 V a.c. / 6 V d.c.	E259 16-10/12	2CSM273693R0401	736936			0.100	12
	24 V a.c. / 12 V d.c.	E259 16-10/24	2CSM273603R0401	736035			0.100	12
	48 V a.c. / 24 V d.c.	E259 16-10/48	2CSM273683R0401	736837			0.100	12
	230 V a.c. / 115 V d.c.	E259 16-10/230	2CSM273593R0401	735939			0.100	12
1NO+1NC	8 V a.c.	E259 16-11/8	2CSM273673R0401	736738			0.100	12
	12 V a.c. / 6 V d.c.	E259 16-11/12	2CSM273583R0401	735830			0.100	12
	24 V a.c. / 12 V d.c.	E259 16-11/24	2CSM273663R0401	736639			0.100	12
	48 V a.c. / 24 V d.c.	E259 16-11/48	2CSM273573R0401	735731			0.100	12
	230 V a.c. / 115 V d.c.	E259 16-11/230	2CSM273653R0401	736530			0.100	12
2NO	8 V a.c.	E259 16-20/8	2CSM273563R0401	735632			0.100	12
	12 V a.c. / 6 V d.c.	E259 16-20/12	2CSM273643R0401	736431			0.100	12
	24 V a.c. / 12 V d.c.	E259 16-20/24	2CSM273553R0401	735533			0.100	12
	48 V a.c. / 24 V d.c.	E259 16-20/48	2CSM273633R0401	736332			0.100	12
	115 V a.c. / 48 V d.c.	E259 16-20/115	2CSM273543R0401	735434			0.100	12
230 V a.c. / 115 V d.c.	E259 16-20/230	2CSM273623R0401	736233			0.100	12	
1CO	8 V a.c.	E259 16-19/8	2CSM273533R0401	735335			0.100	12
	12 V a.c. / 6 V d.c.	E259 16-19/12	2CSM273613R0401	736134			0.100	12
	24 V a.c. / 12 V d.c.	E259 16-19/24	2CSM273523R0401	735236			0.100	12
	48 V a.c. / 24 V d.c.	E259 16-19/48	2CSM274833R0401	748335			0.100	12
	230 V a.c. / 115 V d.c.	E259 16-19/230	2CSM261113R0401	611134			0.100	12
2CO	12 V a.c. / 6 V d.c.	E259 16-29/12	2CSM273513R0401	735137			0.100	12
	24 V a.c. / 12 V d.c.	E259 16-29/24	2CSM273423R0401	734239			0.100	12
	230 V a.c. / 115 V d.c.	E259 16-29/230	2CSM273503R0401	735038			0.100	12

6

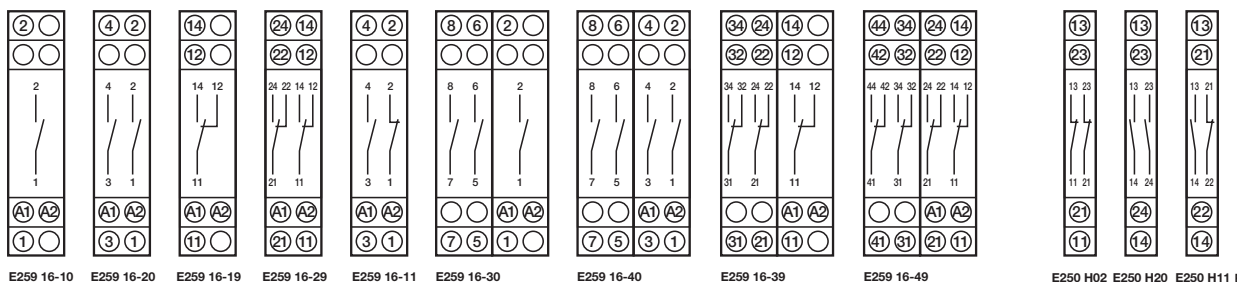

1CSC400065F0202



Contacts	Coil voltage	Order details		Bbn 8012542	Price 1 piece	Price group	Weight 1 piece kg	Pack unit pc.
		Type code	Order code	EAN				
3NO	230 V a.c. / 115 V DC	E259 16-30/230	2CSM272983R0401	729839			0.200	6
4NO	12 V a.c. / 6 V d.c.	E259 16-40/12	2CSM273413R0401	734130			0.200	6
	24 V a.c. / 12 V d.c.	E259 16-40/24	2CSM273493R0401	734932			0.200	6
	48 V a.c. / 24 V d.c.	E259 16-40/48	2CSM272993R0401	729938			0.200	6
	230 V a.c. / 115 V d.c.	E259 16-40/230	2CSM273403R0401	734031			0.200	6
3CO	230 V a.c. / 115 V d.c.	E259 16-39/230	2CSM274783R0401	747833			0.200	6
4CO	230 V a.c. / 115 V d.c.	E259 16-49/230	2CSM273073R0401	730736			0.200	6

Auxiliary contacts

	Rated Current A	Order details		Bbn 8012542	Price 1 piece	Price group	Weight 1 piece kg	Pack unit pc.
		Type code	Order code	EAN				
1NO+1NC	5	E 250 H11	2CSM004400R0201	534709			0.033	16
2NO	5	E 250 H20	2CSM002400R0201	536901			0.033	16
2NC	5	E 250 H02	2CSM008400R0201	536802			0.033	16

Other accessories

Spacer element for heat dissipation	E 259-DIS	2CSM000800R0401					0.04	25
-------------------------------------	------------------	-----------------	--	--	--	--	------	----

Technical features

		1 - 2 contacts	3 - 4 contacts
Rated voltage Un	[V]	250	400
Rated frequency	[Hz]	50	50
Rated current in AC1/AC-7a	[A]	16	16
Control coil characteristics	a.c. power supply voltage	8, 12, 24, 48, 115, 230	12, 24, 48, 230
	d.c. power supply voltage	6, 12, 24, 48, 115	6, 12, 24, 115
	d.c./ a.c. ratio ①	0.5 : 1	0.5 : 1
	Operation limits	±10%	±10%
Power consumption	a.c.		
	pick-up	[VA]	3.4
	holding	[VA]	1.8
	d.c.	[W]	2.1
Load specifications per phase	Maximum load AC-1	[kW]	3
	Maximum load AC-5b	[kW]	1.8
	Maximum load AC-7b	[kW]	0.9
	Maximum load AC-3 (400V)	[kW]	-
	Maximum load DC		③
	Minimum load (under 5V)	[W]	2
	Short circuit fuse protection [gL]	[A]	20
Lifetime in number of operations	Electrical (in AC-1 at full load)	[No.]	3 x 10 ⁵
	Mechanical	[No.]	2 x 10 ⁶
Max. lamp power ②	Incandescent and halogen (40-200W)	[W]	1800
	Fluorescent Parallel p.f. correction (cosφ=0.9)	[VA]	500
	p.f. uncorrected (cosφ=0.5)	[VA]	900
Width (number of DIN modules)	[No.]	1	2
Cable cross section (Ø min/max)	[mm ²]	1.5 / 10	1.5 / 10
Maximum torque on terminals	[Nm]	1	1
Min./Max. ambient T ° at installation point	[°C]	-20 ... +45	-20 ... +45
Standard		IEC EN 60947-4-1, IEC EN 61095	

① Control coil voltage: all the products work both in a.c. and d.c. (with the specified ratio) except the 115 V a.c. version that works at 48 d.c.

② See technical details for lamp types

③ See chart in technical details



2CSC400147F0001

E 250 Latching relays

Allow switching of the contacts in response to each pulse sent to the coil via the normally open pushbuttons. Their high performance in the single or multi-point control of lamps make them an ideal solution for lighting circuits. The manual control lever also gives an indication of the contact position.

The relays come in versions with different coil voltages and contact configurations. The main modules, available in one- and two-contact versions, can be combined with two-pole power contact modules to obtain three-contact and four-contact devices. They can also be provided with auxiliary signal contacts.

E 250, 16 A

Contacts	Coil voltage	Order details	Bbn	Price	Price	Weight	Pack
		Type code	Order code	1 piece	group	1 piece	unit
			EAN			kg	pc.
1NO	8 V a.c.	E 251-8	2CSM211000R0201	53050 3		0.114	12
	12 V a.c. / 6 V d.c.	E 251-12	2CSM311000R0201	53020 6		0.114	12
	24 V a.c. / 12 V d.c.	E 251-24	2CSM411000R0201	53040 4		0.114	12
	48 V a.c. / 24 V d.c.	E 251-48	2CSM511000R0201	53060 2		0.114	12
	230 V a.c. / 115 V d.c.	E 251-230	2CSM111000R0201	53030 5		0.114	12
1NO+1NC	8 V a.c.	E 256-8	2CSM214000R0201	53190 6		0.116	12
	12 V a.c. / 6 V d.c.	E 256-12	2CSM314000R0201	53160 9		0.116	12
	24 V a.c. / 12 V d.c.	E 256-24	2CSM414000R0201	53180 7		0.116	12
	48 V a.c. / 24 V d.c.	E 256-48	2CSM514000R0201	53200 2		0.116	12
	230 V a.c. / 115 V d.c.	E 256-230	2CSM114000R0201	53170 8		0.116	12
2NO	8 V a.c.	E 252-8	2CSM212000R0201	53100 5		0.116	12
	12 V a.c. / 6 V d.c.	E 252-12	2CSM312000R0201	53070 1		0.116	12
	24 V a.c. / 12 V d.c.	E 252-24	2CSM412000R0201	53090 9		0.116	12
	48 V a.c. / 24 V d.c.	E 252-48	2CSM512000R0201	53110 4		0.116	12
	230 V a.c. / 115 V d.c.	E 252-230	2CSM112000R0201	53080 0		0.116	12
1CO	12 V a.c. / 6 V d.c.	E 256.1-12	2CSM315000R0201	53720 5		0.115	12
	24 V a.c. / 12 V d.c.	E 256.1-24	2CSM415000R0201	53740 3		0.115	12
	230 V a.c. / 115 V d.c.	E 256.1-230	2CSM115000R0201	53730 4		0.115	12
2CO	12 V a.c. / 6 V d.c.	E 256.2-12	2CSM316000R0201	53750 2		0.118	12
	24 V a.c. / 12 V d.c.	E 256.2-24	2CSM416000R0201	53770 0		0.118	12
	230 V a.c. / 115 V d.c.	E 256.2-230	2CSM116000R0201	53760 1		0.118	12

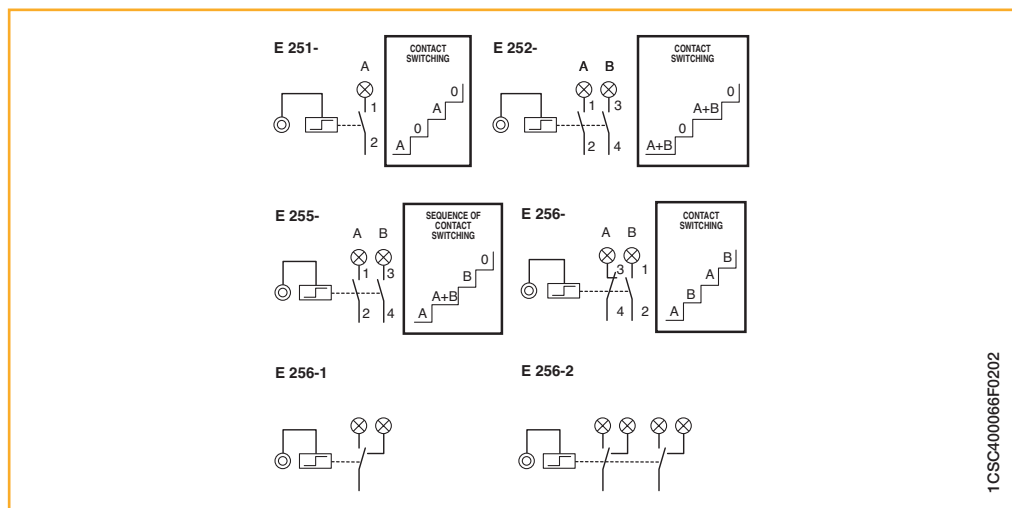

1CSC400066F0202

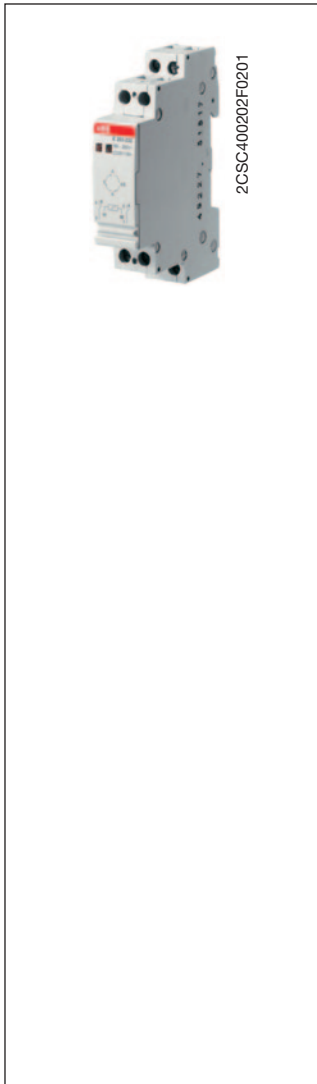

E 250, 32 A

Contacts	Coil voltage	Order details		Bbn 8012542	Price 1 piece	Price group	Weight 1 piece	Pack unit
		Type code	Order code					
1NO	8 V a.c.	E 251-32/8	2CSM231000R0201	91200 2			0.114	12
	12 V a.c. / 6 V d.c.	E 251-32/12	2CSM331000R0201	91210 1			0.114	12
	24 V a.c. / 12 V d.c.	E 251-32/24	2CSM431000R0201	91220 0			0.114	12
	48 V a.c. / 24 V d.c.	E 251-32/48	2CSM531000R0201	91230 9			0.114	12
	115 V a.c. / 48 V d.c.	E 251-32/115	2CSM631000R0201	91240 8			0.114	12
	230 V a.c. / 115 V d.c.	E 251-32/230	2CSM131000R0201	91250 7			0.114	12
2NO	8 V a.c.	E 252-32/8	2CSM232000R0201	91260 6			0.116	12
	12 V a.c. / 6 V d.c.	E 252-32/12	2CSM332000R0201	91270 5			0.116	12
	24 V a.c. / 12 V d.c.	E 252-32/24	2CSM432000R0201	91280 4			0.116	12
	48 V a.c. / 24 V d.c.	E 252-32/48	2CSM532000R0201	91290 3			0.116	12
	115 V a.c. / 48 V d.c.	E 252-32/115	2CSM632000R0201	91300 9			0.116	12
	230 V a.c. / 115 V d.c.	E 252-32/230	2CSM132000R0201	91310 8			0.116	12

E 255, 16 A with 2 sequential contacts

This particular version is equipped with two sequential switching contacts. In the initial stable position both contacts are open: one pulse causes the first contact (A) to close; the next pulse causes the second contact to also close (B); a third pulse causes contact A to open and a final pulse completes the cycle by also reopening contact B, thus returning both contacts to their initial state.

The E255 relays cannot be combined with power contacts or auxiliary devices. They are equipped with two LEDs that give an indication of the contact position.

E 255

Contacts	Coil voltage	Order details		Bbn 8012542	Price 1 piece	Price group	Weight 1 piece	Pack unit
		Type code	Order code					
2	8 V a.c.	E 255-8	2CSM219000R0201	53150 0			0.121	12
	12 V a.c. / 6 V d.c.	E 255-12	2CSM319000R0201	53120 3			0.121	12
	24 V a.c. / 12 V d.c.	E 255-24	2CSM419000R0201	53140 1			0.121	12
	230 V a.c. / 115 V d.c.	E 255-230	2CSM119000R0201	53130 2			0.121	12

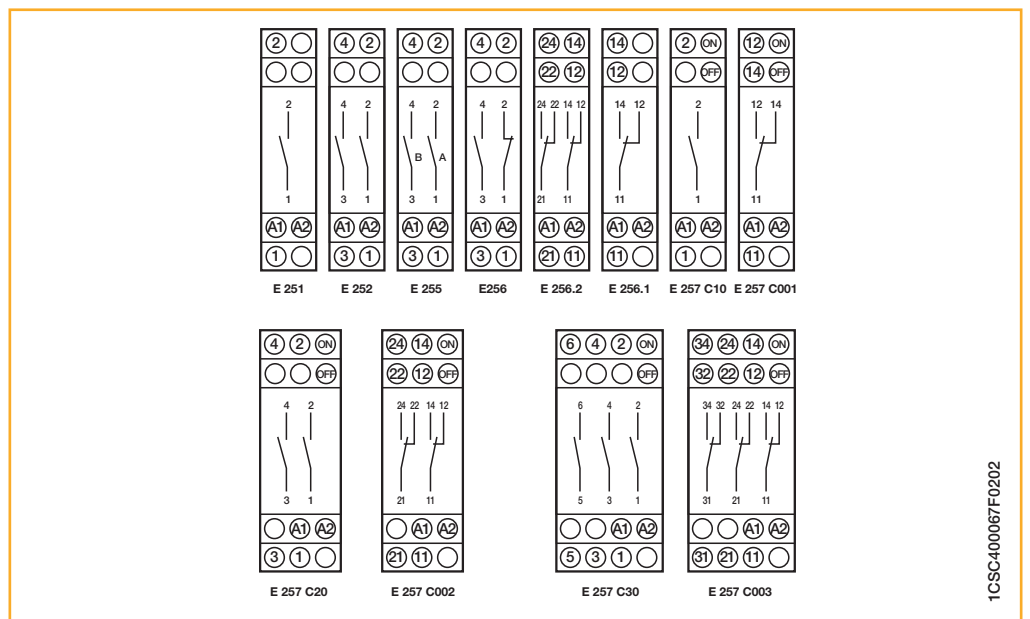



2CSC400208F0201

Latching relays with central command function

The E 257 C and E 258 C versions are latching relays which integrate a central command function (ON and OFF) that allows multiple relays to be controlled from a pair of normally open push-buttons. Using the E 250 GM group module it is also possible to create sub-groups of relays, so as to implement central command of individual subgroups as well as of the entire group of relays. The central command circuit can be permanently supplied, but in that case the circuit of the local coil is excluded.

On E 257 C the central (ON/OFF) command needs to be supplied on the same line as the local pushbuttons (see diagram below). This is not required for E 258 C, which can thus also be supplied on the central command at a different voltage than the local pushbuttons circuit.

E 257, 16 A

Contacts	Coil voltage	Order details		Bbn 8012542	Price 1 piece	Price group	Weight 1 piece	Pack unit
		Type code	Order code					
1NO	12 V a.c. / 6 V d.c.	E 257 C10-12	2CSM311000R0211	53210 1			0.126	12
	24 V a.c. / 12 V d.c.	E 257 C10-24	2CSM411000R0211	53230 9			0.126	12
	230 V a.c. / 115 V d.c.	E 257 C10-230	2CSM111000R0211	53220 0			0.126	12
2NO	12 V a.c. / 6 V d.c.	E 257 C20-12	2CSM312000R0211	53240 8			0.174	8
	24 V a.c. / 12 V d.c.	E 257 C20-24	2CSM412000R0211	53260 6			0.174	8
	230 V a.c. / 115 V d.c.	E 257 C20-230	2CSM112000R0211	53250 7			0.174	8
3NO	12 V a.c. / 6 V d.c.	E 257 C30-12	2CSM313000R0211	53480 8			0.240	6
	24 V a.c. / 12 V d.c.	E 257 C30-24	2CSM413000R0211	53500 3			0.240	6
	230 V a.c. / 115 V d.c.	E 257 C30-230	2CSM113000R0211	53490 7			0.240	6
1CO	12 V a.c. / 6 V d.c.	E 257 C001-12	2CSM315000R0211	54020 5			0.126	12
	24 V a.c. / 12 V d.c.	E 257 C001-24	2CSM415000R0211	54010 6			0.126	12
	230 V a.c. / 115 V d.c.	E 257 C001-230	2CSM115000R0211	54000 7			0.126	12
2CO	12 V a.c. / 6 V d.c.	E 257 C002-12	2CSM316000R0211	54050 2			0.174	8
	24 V a.c. / 12 V d.c.	E 257 C002-24	2CSM416000R0211	54040 3			0.174	8
	230 V a.c. / 115 V d.c.	E 257 C002-230	2CSM116000R0211	54030 4			0.174	8
3CO	12 V a.c. / 6 V d.c.	E 257 C003-12	2CSM317000R0211	54080 9			0.240	6
	24 V a.c. / 12 V d.c.	E 257 C003-24	2CSM417000R0211	54070 0			0.240	6
	230 V a.c. / 115 V d.c.	E 257 C003-230	2CSM117000R0211	54060 1			0.240	6

6

E 257 - local and central command by push-buttons

Each local push-button controls a single relay. Pressing the central ON/(OFF) button puts all the relays in the ON (/OFF) position irrespective of their previous state.

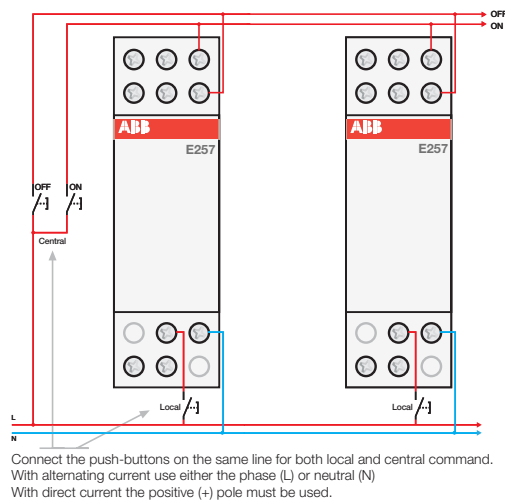

E 257 - permanently supplied

It is possible to permanently supply the central command, for example using a change-over switch to control the relay.

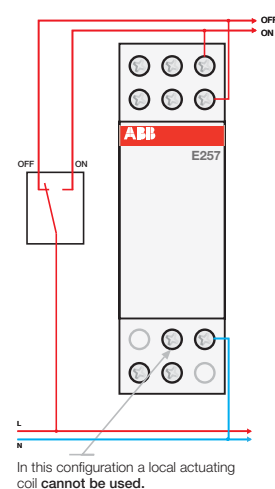

1CSC400068F0202



E 257, 32 A

Contacts	Coil voltage	Order details		Bbn 8012542	Price 1 piece	Price group	Weight 1 piece	Pack unit
		Type code	Order code	EAN			kg	pc.
1NO	12 V a.c. / 6 V d.c.	E 257-32C10/12	2CSM331000R0211	91320 7			0.126	12
	24 V a.c. / 12 V d.c.	E 257-32C10/24	2CSM431000R0211	91330 6			0.126	12
	230 V a.c. / 115 V d.c.	E 257-32C10/230	2CSM131000R0211	91340 5			0.126	12
2NO	12 V a.c. / 6 V d.c.	E 257-32C20/12	2CSM332000R0211	91350 4			0.174	8
	24 V a.c. / 12 V d.c.	E 257-32C20/24	2CSM432000R0211	91360 3			0.174	8
	230 V a.c. / 115 V d.c.	E 257-32C20/230	2CSM132000R0211	91370 2			0.174	8
3NO	12 V a.c. / 6 V d.c.	E 257-32C30/12	2CSM333000R0211	91380 1			0.240	6
	24 V a.c. / 12 V d.c.	E 257-32C30/24	2CSM433000R0211	91390 0			0.240	6
	230 V a.c. / 115 V d.c.	E 257-32C30/230	2CSM133000R0211	91400 6			0.240	6

E 258 C, 16 A

Contacts	Order details		Bbn 8012542	Price 1 piece	Price group	Weight 1 piece	Pack unit
	Type code	Order code	EAN			kg	pc.
Local coil voltage 230 V a.c. / 115 V d.c., central ON/OFF 24 V a.c./d.c.							
1 NO	E 258 C10-230/24	2CSM211000R0231	78910 9			0.226	6
2 NO	E 258 C20-230/24	2CSM212000R0231	78830 0			0.235	6
1 NO + 1 NC	E 258 C11-230/24	2CSM213000R0231	78870 6			0.232	6
1 NO + 1 NC + 1 CO	E 258 C111-230/24	2CSM215000R0231	78890 4			0.239	6
2 NO + 1 CO	E 258 C201-230/24	2CSM214000R0231	78850 8			0.241	6
2 CO	E 258 C002-230/24	2CSM216000R0231	78960 4			0.25	6
3 CO	E 258 C003-230/24	2CSM217000R0231	78990 1			0.256	6

Grouped central command: connection diagram for E 250 GM

The E250 GM module allows the creation of subgroups of relays with a central command for each group of relays and a general command. This function requires using an E 250 GM for each subgroup.

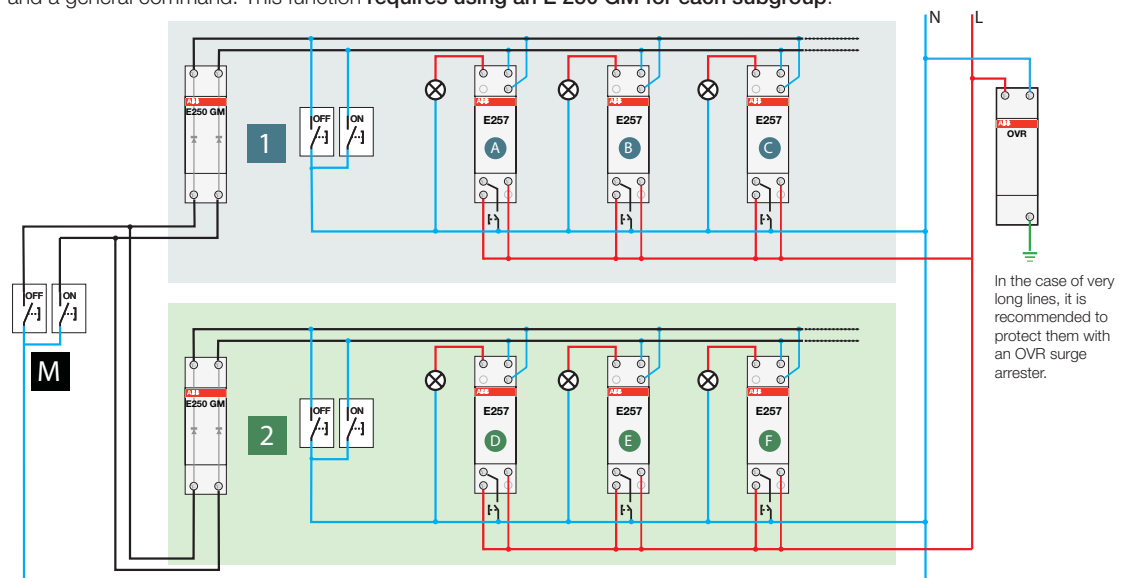

Local: each relay can be individually commanded from the local pushbuttons.

Group: each group can be centrally commanded, therefore the ON/OFF 1 button controls relays A B C while the ON/OFF 2 button controls relays D E F

General: the ON/OFF buttons M command both groups 1 2 at simultaneously, allowing all the relays to be commanded.

1CSC400069F0202



2CSC400729F0201

6

Local coil voltage 230 V a.c. / 115 V d.c., central ON/OFF 230 V a.c./d.c.

1 NO	E 258 C10-230/230	2CSM111000R0231	78920 8	0.233	6
2 NO	E 258 C20-230/230	2CSM112000R0231	78840 9	0.243	6
1 NO + 1 NC	E 258 C11-230/230	2CSM113000R0231	78880 5	0.24	6
1 NO + 1 NC + 1 CO	E 258 C111-230/230	2CSM115000R0231	78900 0	0.244	6
2 NO + 1 CO	E 258 C201-230/230	2CSM114000R0231	78860 7	0.247	6
2 CO	E 258 C002-230/230	2CSM116000R0231	78970 3	0.257	6
3 CO	E 258 C003-230/230	2CSM117000R0231	79000 6	0.262	6

Local coil voltage 24 V a.c. / 12 V d.c., central ON/OFF 24 V a.c./d.c.

1 NO	E 258 C10-24/24	2CSM411000R0231	79010 5	0.225	6
2 NO	E 258 C20-24/24	2CSM412000R0231	78930 7	0.234	6
2 NO + 1 CO	E 258 C201-24/24	2CSM414000R0231	78940 6	0.241	6
2 CO	E 258 C002-24/24	2CSM416000R0231	78950 5	0.249	6
3 CO	E 258 C003-24/24	2CSM417000R0231	78980 2	0.256	6

Auxiliary components and accessories for E 250

Contacts	Rated current	Order details	Bbn	Price	Price group	Weight	Pack
		Type code	Order code	8012542	1 piece	1 piece	unit
				EAN		kg	pc.

Additional power contacts for all coil voltages

2NO	16A	E 250 CM20	2CSM012100R0201	53460 0	0.058	10
1NO+1NC	16A	E 250 CM11	2CSM014100R0201	53450 1	0.058	10
2CO	16A	E 250 CM002	2CSM016100R0201	53440 2	0.059	10
2NO	32A	E 250-32 CM20*	2CSM032100R0201	91410 5	0.058	10

* To be used only with 32 A latching relays

Auxiliary contacts

1NO+1NC	5A	E 250 H11	2CSM004400R0201	53470 9	0.033	16
2NO	5A	E 250 H20	2CSM002400R0201	53690 1	0.033	16
2NC	5A	E 250 H02	2CSM008400R0201	53680 2	0.033	16

Other accessories

central command for E251, E252 and E256	E 257 CM	2CSM000200R0211	53510 2	0.033	16
group module	E 250 GM	2CSM000600R0201	53700 7	0.058	12
compensator module	E 250 CP	2CSM000500R0201	53710 6	0.058	12

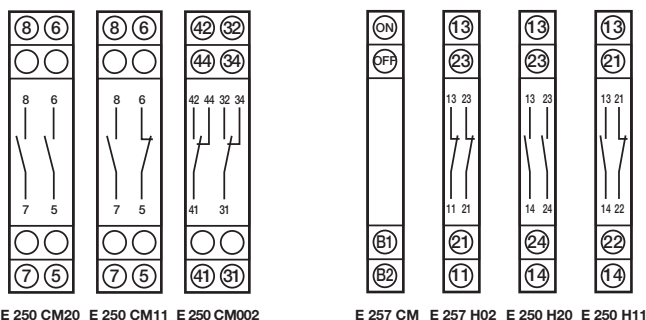

1CSC400067F0202

Technical characteristics

		E 251 / E 252 / E 256		E 255		
Rated current I_n	[A]	16	32	16		
Rated voltage U_n	[V]	250 (1-2 contacts) 400 (3-4 contacts)	250 (1-2 contacts) 400 (3-4 contacts)	250		
Rated frequency	[Hz]	50/60 ①	50/60 ①	50/60 ①		
Contacts	main module	NO	1 - 2	1 - 2	1 + 1	
		change-over	1 - 2	1 - 2	-	
		NO+NC	1 + 1	1 + 1	-	
	additional power contacts	NO	2	2	-	
		change-over	2	-	-	
		NO+NC	1+1	-	-	
Width (no. of DIN modules)	main module	[mod.]	1	1	1	
	with additional power contacts	[mod.]	2	2	-	
Control coil characteristics	supply voltage: d.c. / a.c. ratio ②		0,5 : 1	0,5 : 1	0,5 : 1	
	tolerance on supply voltage		±10%	±10%	±10%	
	power consumption a.c.	holding ③	[VA]	11	11,5	11
		pick-up	[VA]	14,5	16,5	14,5
power consumption d.c.			[W]	7,5	8	7,5
			[W]	7,5	8	7,5
Pulse durations	minimum pulse duration (at U _n)		[s]	0,05	0,05	0,05
	minimum pulse duration (90% U _n)		[s]	0,1	0,1	0,1
	minimum interval between two pulses		[s]	0,15	0,15	0,15
	maximum number of pulses per minute			250	250	250
Lifetime in number of operations ④	electrical (in AC-1 at full load)			4 x 10 ⁵	3 x 10 ⁵	3 x 10 ⁵
	mechanical			2 x 10 ⁶	2 x 10 ⁶	2 x 10 ⁶
Load characteristics	maximum load in AC-1 per phase		[A]	20	32	20
	maximum load in DC		[A]	⑥	⑥	⑥
	minimum load per phase (under 5 V)		[W]	2	2	2
	short circuit protection fuse (gL)		[A]	20	32	20
Maximum no. of lamps (10³ operations/h)	incandescent and halogen		[W]	3000	4000	3000
	fluorescent, corrected power factor (cosφ = 0,9)	series	[VA]	4000	4000	3000
		parallel	[VA]	2500	3200	2500
	fluorescent, uncorrected power factor (cosφ = 0,5)		[VA]	1800	2200	1800
Maximum number of buttons	non illuminated			unlimited	unlimited	unlimited
	illuminated	3 wires		unlimited	unlimited	unlimited
		2 wires		⑤	⑤	⑤
General characteristics	DIN rail mount			yes	yes	yes
	hooking on bistable DIN rail			yes	yes	yes
	two position knob			yes	yes	-
	contact position indication			yes	yes	yes
	label-holder			yes	yes	yes
	cage terminals			yes	yes	yes
	captive screws			yes	yes	yes
	sealable terminals			yes	yes	yes
	cable section (o min./max.)		[mm ²]	1,5/10 (2P: 6)	1,5/10 (2P: 6)	1,5/10
	min./max. operating temperature		[°C]	-20...+45	-20...+46	-20...+45

① All latching relays can also be used at 60Hz. In this case and excluding E255, you can use maximum one auxiliary contact E250H but it is not possible to use power contacts E250CM.

② Supply voltage: all devices operate in both a.c. and d.c., with the specified voltage ratios, except for the 115 V a.c. version that operates at 48 V d.c..

③ The relays can withstand the "button stuck" condition. When the application calls for the relays to be permanently supplied, spacers must be used on either side, making sure that the duty cycle allows the device to cool down to ambient temperature.

④ 1 cycle = 2 operations per pole (closing + opening)

⑤ See table for use of the E 250 CP compensator modules

⑥ See chart in technical details

Technical characteristics

		E 257 C		E 258 C	
Rated voltage Un	[V]	250 (1-2 contacts) 400 (3 contacts)	250 (1-2 contacts) 400 (3 contacts)	250 (1-2 contacts) 400 (3 contacts)	
Rated current In	[A]	16	32	16	
Rated frequency	[Hz]	50/60 ①	50/60 ①	50/60 ①	
Contacts	NO	1...3	1...3	1...3	
	change-over	1...3	-	1...3	
	NO+NC	-	-	1 + 1	
Width (no. of DIN modules)	[mod.]	1 - 2	1 - 2	2	
Control coil characteristics	supply voltage: d.c / a.c. ratio ②		0,5 : 1	0,5 : 1	
	tolerance on supply voltage		±10%	±10%	
	power consumption a.c.	holding ③ [VA]	11	14,5	14,5
		pick-up [VA]	11	14,5	14,5
	power consumption d.c.	[W]	7,5	8	8
ON-OFF command characteristics	supply voltage			24 V a.c./d.c. 230 V a.c./d.c.	
	tolerance on supply voltage		see control coil characteristics	±10%	
	power consumption a.c.	holding ③ [VA]		12	
		pick-up [VA]		12	
	power consumption d.c.	[W]		12,5	
Pulse durations	minimum pulse duration (at Un)	[s]	0,05	0,05	
	minimum pulse duration (90% Un)	[s]	0,1	0,1	
	minimum interval between two pulses	[s]	0,15	0,15	
	maximum number of pulses per minute		250	250	
Lifetime in number of operations ④	electrical (in AC-1 at full load)		4 x 10 ⁵	3 x 10 ⁵	
	mechanical		2 x 10 ⁶	2 x 10 ⁶	
Load characteristics	maximum load in AC-1 per phase	[A]	20	32	
	maximum load in DC	[A]	⑥	⑥	
	minimum load per phase (under 5 V)	[W]	2	2	
	short circuit protection fuse (gL)	[A]	20	32	
Maximum no. of lamps (10³ operations/h)	incandescent and halogen	[W]	3000	4000	
	fluorescent, corrected power factor (cosφ = 0,9)	series [VA]	3000	4000	
		parallel [VA]	2500	3200	
	fluorescent, uncorrected power factor (cosφ = 0,5)	[VA]	1800	2200	
Maximum number of buttons	non illuminated		unlimited	unlimited	
	illuminated	3 wires	unlimited	unlimited	
		2 wires	⑤	⑤	
General characteristics	DIN rail mount		yes	yes	
	hooking on bistable DIN rail		yes	yes	
	two position knob		yes	yes	
	contact position indication		yes	yes	
	label-holder		yes	yes	
	cage terminals		yes	yes	
	captive screws		yes	yes	
	sealable terminals		yes	yes	
	cable section (o min./max.)	[mm ²]	1,5/10	1,5/10	
	min./max. operating temperature	[°C]	-20...+45	-20...+45	

- ① All latching relays can also be used at 60Hz. In this case and excluding E255, you can use maximum one auxiliary contact E250H but it is not possible to use power contacts E250CM.
- ② Supply voltage: all devices operate in both a.c. and d.c., with the specified voltage ratios, except for the 115 V a.c. version that operates at 48 V d.c..
- ③ The relays can withstand the "button stuck" condition. When the application calls for the relays to be permanently supplied, spacers must be used on either side, making sure that the duty cycle allows the device to cool down to ambient temperature.
- ④ 1 cycle = 2 operations per pole (closing + opening)
- ⑤ See table for use of the E 250 CP compensator modules
- ⑥ See chart in technical details



Flush mounting latching relays

Speed and ease of assembly, along with their compact size, make the FLR flush mounting latching relays suitable for installation inside flush mount or junction boxes. They are ideal for implementing multipoint command of lighting systems in residential and commercial installations, so as to simplify and reduce the cost of wiring.

Contacts	Order details	Bbn	Price	Price group	Weight	Pack unit
	Type code	Order code	1 piece		1 piece	
					kg	pc.
1	FLR1-12	2CSM206365R0241	063650		0.06	20
1	FLR1-230	2CSM206375R0241	063759		0.06	20
2	FLR5-12	2CSM206385R0241	063858		0.06	20
2	FLR5-230	2CSM206395R0241	063957		0.06	20

Technical features

	FLR1	FLR5
Contact type	1NO	2NO
Number of sequences [No.]	2	4
Rated voltage [V]	12 / 230 AC	
Rated load	10 A / 250 V AC	
Max. Peak current [A]	15	
Max. switching power [VA]	2500	
Max. switching voltage [V]	250 AC	
Incandescent lamp load [W]	805	
Fluorescent lamp load [W]	345	
Frequency [Hz]	50-60	
Type of operation	sequential - mechanical	
Protection degree	IP20	
Max. number of electrical operations [No.]	100000	
Max. number of mechanical operations [No.]	300000	
Insulation resistance [MΩ]	100 (500 V DC)	
Dielectric strength (contacts) [V]	2000 AC	
Dielectric strength (coil) [V]	3500 AC	
Power dissipation [VA]	4.5	
Operating temperature [°C]	-25...+55	
Max. Cable section at terminals [mm²]	1...2.5	
Terminals	screw	
Installation type	wall/flush mounting	
Dimensions (LxWxH) [mm]	45 x 22 x 45	
Standards	EN 60669-1 ; EN 60669-2-1	

6

Characteristics of the contact

Type	No. of pulses	Sequences			
		1	2	3	4
FLR1-12	2				
FLR1-230	2				
FLR5-12	2				
FLR5-230	2				

Connection diagram

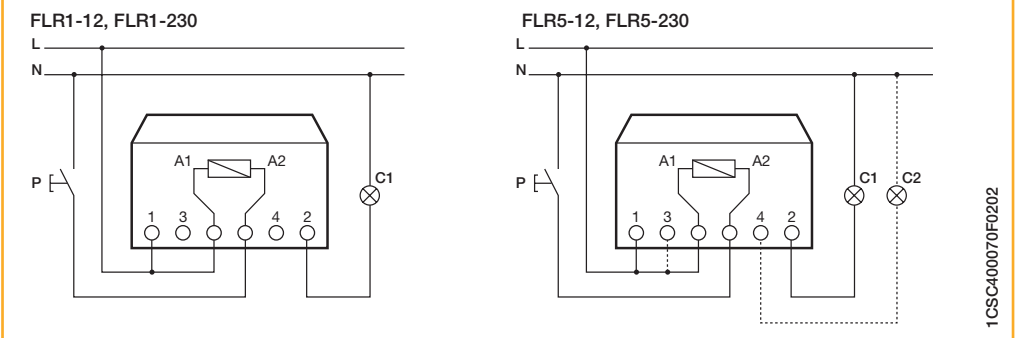

1CSC40070F0202

E 260 electronic latching relays

The electronic version of latching relays guarantees maximum reliability, life, and noiseless operation. The E 260 C version also allows centralized reset function (ON/OFF).

Contacts	Power loss	Order details	Bbn	Price	Price group	Weight	Pack unit
	W ①	Type code	4016779	1 piece		1 piece	
		Order code	EAN			kg	pc.

① Values in brackets indicate power loss when permanently excited, rated voltage and rated contact loading.

Latching relays with control electronics

Coil voltage $U_c = 24 \text{ V AC/DC}$

1 NO	2.4 (3.0)	E 261-24	2CDE441000R0301	57592 8		0.085	1
1 NO+1 NC	2.4 (3.5)	E 266-24	2CDE444000R0301	57595 9		0.096	1
2 NO	2.4 (3.5)	E 262-24	2CDE442000R0301	57593 5		0.096	1

Coil voltage $U_c = 230 \text{ V AC}$

1 NO	1.5 (2.0)	E 261-230	2CDE141000R0301	57596 6		0.085	1
1 NO+1 NC	1.7 (3.6)	E 266-230	2CDE144000R0301	57598 0		0.096	1
2 NO	1.7 (3.6)	E 262-230	2CDE142000R0301	57597 3		0.096	1



6

Connection examples

E 261-230

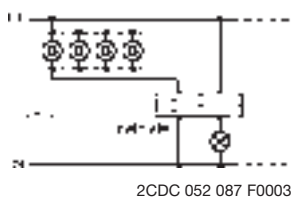

E 261 C-230

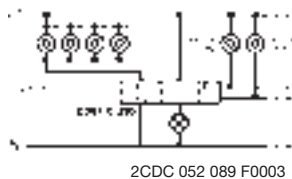

E 266 C-230

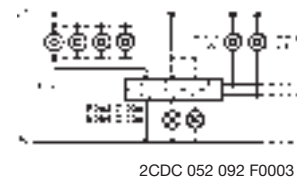

E 261-24

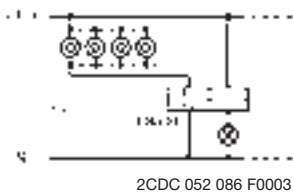

E 261 C-24

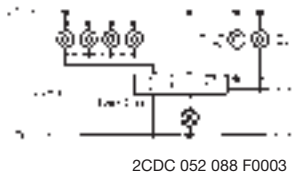

* E 260 C
Caution!
The same electr. potential must be applied to terminals A1, B1 and C1.

2CSC400077F0201

Latching relays with returning time

They switch off automatically after expiry of preset delay time (1 to 60 min.) if the manual OFF command has not been received. Glow lamp current 50 mA.

Coil voltage $U_c = 230$ V AC

1 NO	1.5 (2.0)	E 261 SRV-230	2CDE111010R0301	57605 5	0.07	1
------	-----------	---------------	-----------------	---------	------	---

Technical features

	E 260/E 260 C	E 261 SRV-230
Rated load at 250 V AC	8 A	16 A
Incandescent lamp load	1000 W	1600 W
Fluorescent lamp load in twin-lamp circuit	1000 W	1000 W
Fluorescent lamp load shunt compensated	350 W ①	500 W
Fluorescent lamp load inductive or capacitive	500 W	1000 W
Electronic ballast	I_{on} m 70 A/10 ms ②	I_{on} m 70 A/10 ms ②
Inductive load, $\cos\varphi = 0.6/230$ V ~	5 A	5 A
Contact rating at DC	100 W	100 W
Minimum contact rating	4 V AC/10 mA	4 V AC/10 mA
Contact gap/contact material	0.5 mm/Ag SnO ₂	0.5 mm/Ag SnO ₂
Service life mechanical switchover at 10 ³ /h	> 10 ⁷	> 10 ⁷
Service life at rated load $\cos\varphi = 1$ and 10 ³ /h	> 10 ⁵	> 10 ⁵
Service life with filament lamps at 10 ³ /h	800 W > 10 ⁵ , 1000 W > 0.8x10 ⁵	1000 W > 10 ⁵
Service life at rated load $\cos\varphi = 0.6$ and 10 ³ /h	> 10 ⁴	> 10 ⁴
Max. switching rate	10 ³ /h	10 ³ /h
Bounce time	3 ms	
Connection capacity	2 x 1.5 mm ² with connector sleeve 2 x 2.5 mm ² without connector sleeve	
Tightening torque	0.5 ... 0.8 Nm	0.5 ... 0.8 Nm
ON duration at rated voltage	100 %	100 %
Coil voltage range	0.9 to 1.1 U_n	0.9 to 1.1 U_n
Minimum command time/interval between commands	50/1000 ms	50 ms
Ambient temperature	-20 °C / -4 °F to 50 °C / 122 °F	-20 °C / -4 °F to 50 °C / 122 °F
Control current when controlled locally	230 V AC 115 mA, after 10s 8 mA ± 20 % 24 V UC 140 mA, after 10s 80 mA ± 20 %	
Control current when controlled centrally	230 V AC 8 mA, after 10s 3 mA ± 20 % 24 V UC 17 mA ± 20 %	
Max. parallel capacity of individual control wire at 230 V ~	0.7 µF (ca. 2000 m)	
Max. parallel capacity of central control wire at 230 V ~	0.2 µF (ca. 700 m)	
Max. glow lamp current – parallel to 230 V control buttons	10 mA	10 mA
Max. induced voltage at 230 V control inputs	0.2 U_n	120 V

Latching relays for lamp installations on request.

① E 260 C can not be used with fluorescent lamp load shunt compensated.

② In the case of electronic control gear, take into account a 40-fold inrush current.

Latching relays with control electronics for central ON/OFF switch

The central commands have always priority and reliably switch on/off any given number of devices connected in parallel, irrespective of their previous switching position. Local control inputs are blocked when a central command is received. Same potential at central / local control input.

Contacts	Power loss	Order details	Bbn	Price	Price group	Weight	Pack unit
	W ①	Type code	4016779	1 piece		1 piece	
		Order code	EAN			kg	pc.

① Values in brackets indicate power loss when permanently excited, rated voltage and rated contact loading.

Coil voltage $U_c = 24$ V AC/DC

1 NO	2.4 (3.0)	E 261 C-24	2CDE441000R0311	57599 7		0.085	1
1 NO+1 NC	2.4 (3.5)	E 266 C-24	2CDE444000R0311	57601 7		0.096	1
2 NO	2.4 (3.5)	E 262 C-24	2CDE442000R0311	57600 0		0.096	1

Coil voltage $U_c = 230$ V AC

1 NO	1.5 (2.0)	E 261 C-230	2CDE141000R0311	57602 4		0.085	1
1 NO+1 NC	1.7 (3.0)	E 266 C-230	2CDE144000R0311	57604 8		0.096	1
2 NO	1.7 (3.0)	E 262 C-230	2CDE142000R0311	57603 1		0.096	1

6

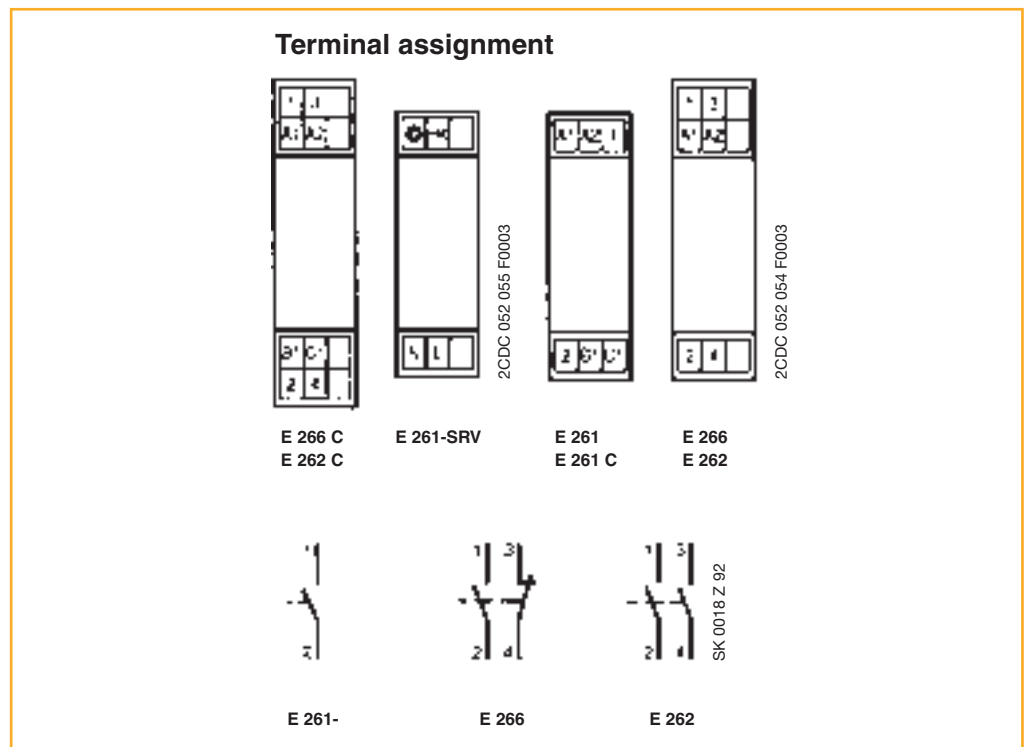
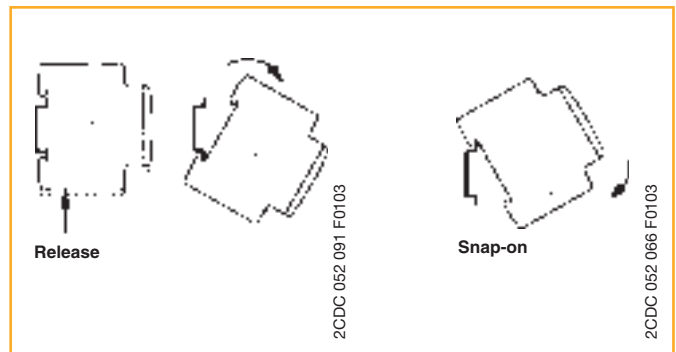
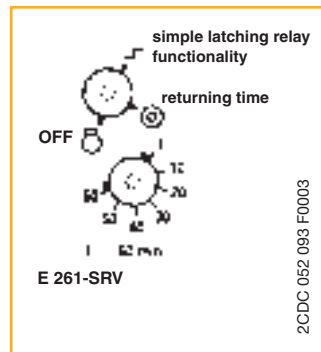



STD50 dimmers for the control of lamps and ballast

Description/ application	Power loss	Order details	Bbn 4016779	Price 1 piece	Price group	Weight 1 piece	Pack unit
	W	Type code	Order code	EAN		kg	pc.

Dimmer for brightness control of filament lamps , 230 V tungsten halogen lamps, Iv halogen lamps with conventional transformers (phase control)

5 ①	STD 50-3	GH V021 1370 R0074	02790 8			0.155	1
-----	-----------------	--------------------	----------------	--	--	-------	---

Dimmer for brightness control of filament lamps , 230 V tungsten halogen lamps, Iv halogen lamps with ABB electronic transformers (reverse phase)

4 ①	STD 50-4	GH V021 1370 R0075	03300 8			0.105	1
-----	-----------------	--------------------	----------------	--	--	-------	---

① power loss = 1% of connected load (4 or 5 W max)

Technical features

Rated voltage	230 V ~ 50 Hz
Ambient temperature	0 °C to + 35 °C
Interference suppression	CE

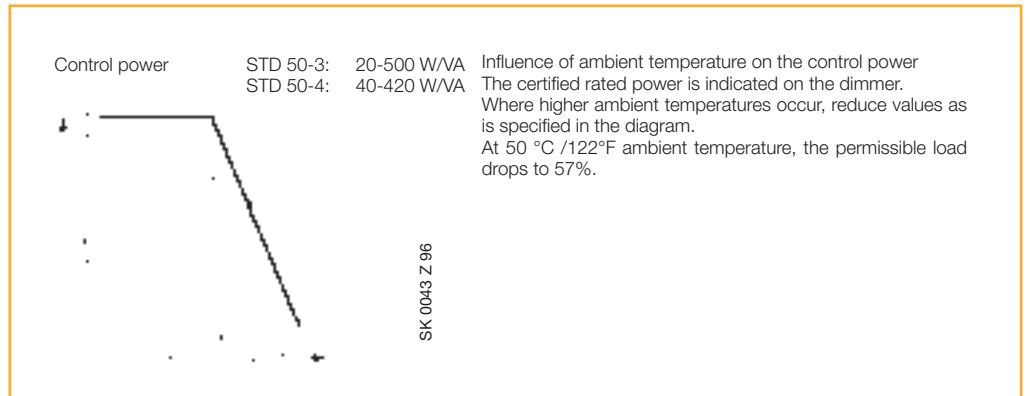



Electronic potentiometer for electronic control gear with control input 0/1 - 10 V DC, control current 50 mA DC

Rated current (terminal 3 and 4) 4 A $\cos\phi = 0.9$; switching capacity 700 VA

Description/ application	Power loss	Order details	Bbn 4016779	Price 1 piece	Price group	Weight 1 piece	Pack unit
	W	Type code	Order code	EAN		kg	pc.
	5 ①	STD-EP	GH V021 1370 R0076	27050 2		0.073	1

Memory touch controller for electronic control gear

Rated voltage/switching output 4 A (~ 10 electronic control gear units) $\cos\phi = 0.9$; 3 A $\cos\phi = 0.5$, switching capacity 700 VA

for electronic control gear with control input 1 - 10 V DC control current 50 mA max.	1	STD-MTS	GH V021 0881 R0004	27070 0		0.110	1
---	---	---------	--------------------	---------	--	-------	---

① power loss = 1% of connected load (7 W max)

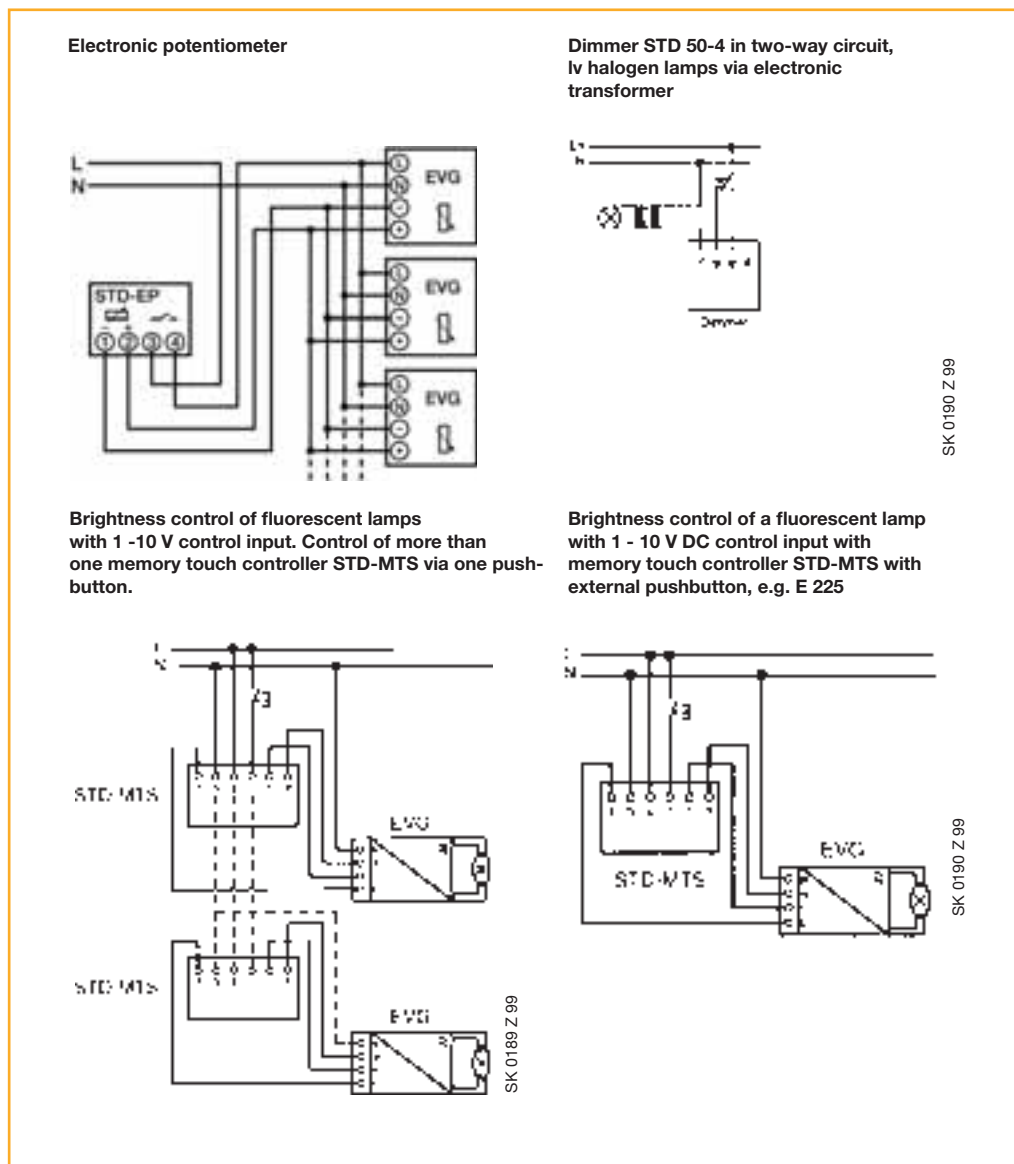

SK 0190 Z 99

SK 0190 Z 99

SK 0189 Z 99



Universal dimmer for phase control and reverse phase control

Universal dimmer STD-500 U and the connected power extension unit STD-420 E are suitable for the brightness control of:

- glow lamps
- 230 V halogen glow lamps
- lv halogen glow lamps with conventional transformer (phase control)
- electronic transformers for lv halogen glow lamps (reverse phase control) e.g.: ABB ETR-70-230, 105-230, 150-230

The STD-500 U dimmer can be operated by one or more unlit pushbuttons (N- or L-controlled) or via a data line:

- EIB control element SB/S
- Powernet control element PSB

Power unit STD-420 E is used to boost the connected load and is controlled exclusively by the preset command of the STD-500 U dimmer. The parallel connection of the outputs of the universal high-performance dimmer and the pertaining power extensions (up to 6 units; connection with enclosed RJ 12 line cut to length) allow for a dimming power of 3,000 W/VA max at one load line.

Not suitable for dimming fluorescent lamps, transformers with current monitor and high-reactance transformers.

Description/ application	Power loss	Order details	Bbn 4011395	Price 1 piece	Price group	Weight 1 piece	Pack. unit
	W	Type code	Order code	EAN		kg	pc.
high-performance dimmer	6	STD-500 U	GJB0 006 590 A0178	06692 8			1
extension	6	STD-420 E	GJB0 006 590 A0179	06693 5			1
rotary operation element	-	STD-OCD	GJB0 006 590 A0183	06698 0			1
button operation element	-	STD-OCP	GJB0 006 590 A0181	06695 9			1
timer operation element	-	STD-OCT	GJB0 006 590 A0185	07056 7			1

Note: Load and control cables must not be laid in one cable.

Technical features

Rated voltage	230 V ~ ± 10%, 50/60 Hz	
Rated current	STD U	2.17 A
	STD E	1.83 A
Max. connected load	U	500 W/VA
	E	420 W/VA
Power extension	1 U + max. 6 E/phase => max. 3 kVA	
Min. connected load	STD U	60 W/VA
	STD E	200 W/VA
Max. line length	100 m pushbutton cable, 2 m data line	
Interference suppression	CE	
Ambient temperature	0 to + 45°C, higher temperatures reduce the power	

Electronic protection against short circuit, overload, excessive temperature, automatic load recognition, soft-OFF function optional, memory function, minimum brightness control, visual overload indication

Connected load / ambient temperature diagram

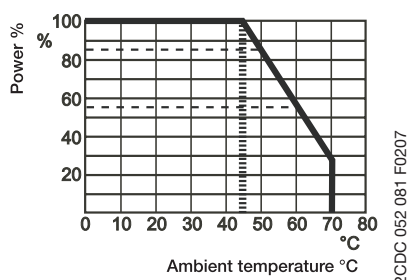

Universal dimmer for phase control and reverse phase control

Plug-in operation elements:

- pushbutton operation element (STD-OCP)
- rotary operation element (STD-OCD)
- timer (STD-OCT)

Application

Remove dimmer cap and snap on operation element to provide for control of dimmer with central pushbutton or rotary operation. Local operation elements are still active. Apart from the manual local control feature, the timer also allows for time-programmed operations.

Basic timer functions:

- year time switch with 48 time programs
- optional with/without decentralized pushbutton control
- special programs: adjustable background brightness, cycle, display and emergency light, holiday program
- running reserve: 5 hours

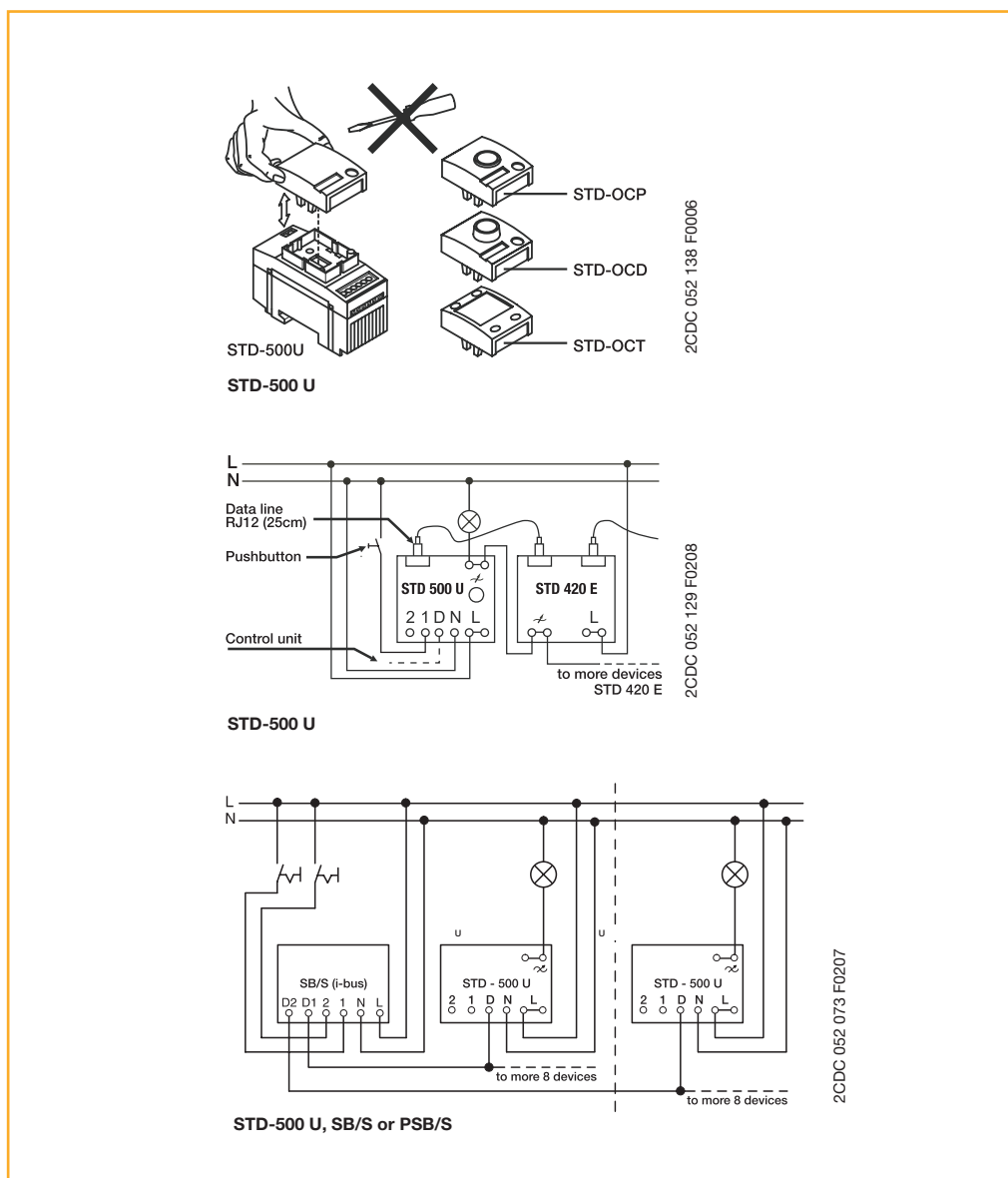

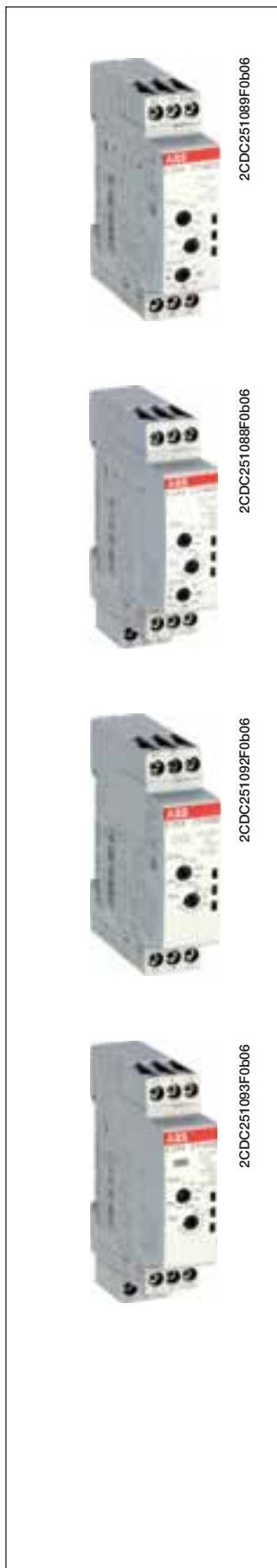

E 234 electronic timers

Rated control voltage	Control input	Order details	Bbn	Price 1 piece	Price group	Weight 1 piece	Pack unit
V		Type code	Order code	EAN		kg	pc.

Multifunction timers

E 234 CT-MFD: 7 functions ¹⁾, 7 time ranges (0.05 s- 100 h), 2 c/o contacts, 2 LEDs

12-240 AC/DC	yes	E 234 CT-MFD.21	1SVR 500 020 R1100			0.065	1
--------------	-----	------------------------	--------------------	--	--	-------	---

E 234 CT-MFD: 7 functions ¹⁾, 7 time ranges (0.05 s- 100 h), 1 c/o contact, 2 LEDs

24-48 DC, 24-240 AC	yes	E 234 CT-MFD.12	1SVR 500 020 R0000			0.060	1
------------------------	-----	------------------------	--------------------	--	--	-------	---

ON-delay timers ☒

E 234 CT-ERD: 7 time ranges (0.05 s- 100 h), 2 c/o contacts, 2 LEDs

24-48 DC, 24-240 AC		E 234 CT-ERD.22	1SVR 500 100 R0100			0.065	1
------------------------	--	------------------------	--------------------	--	--	-------	---

E 234 CT-ERD: 7 time ranges (0.05 s- 100 h), 1 c/o contact, 2 LEDs

24-48 DC, 24-240 AC		E 234 CT-ERD.12	1SVR 500 100 R0000			0.060	1
------------------------	--	------------------------	--------------------	--	--	-------	---

OFF-delay timers ■

E 234 CT-AHD: 7 time ranges (0.05 s- 100 h), 2 c/o contacts, 2 LEDs

24-48 DC, 24-240 AC	yes	E 234 CT-AHD.22	1SVR 500 110 R0100			0.065	1
------------------------	-----	------------------------	--------------------	--	--	-------	---

E 234 CT-AHD: 7 time ranges (0.05 s- 100 h), 1 c/o contact, 2 LEDs

24-48 DC, 24-240 AC	yes	E 234 CT-AHD.12	1SVR 500 110 R0000			0.060	1
------------------------	-----	------------------------	--------------------	--	--	-------	---

¹⁾ Functions: ON-delay, OFF-delay with auxiliary voltage, Impulse-ON, Impulse-OFF with auxiliary voltage, Flasher starting with ON, Flasher starting with OFF, Pulseformer



2CDC251095F0b06



2CDC251096F0b06



2CDC251098F0b06



2CDC251099F0b06

Rated control voltage	Control input	Order details	Bbn	Price 1 piece	Price group	Weight 1 piece	Pack unit
V		Type code	Order code	EAN		kg	pc.

Impulse-ON  

E 234 CT-VWD: 7 time ranges (0.05 s- 100 h), 1 c/o contact, 2 LEDs

24-48 V DC, 24-240 V AC		E 234 CT-VWD.12	1SVR 500 130 R0000			0.060	1
----------------------------	--	------------------------	--------------------	--	--	-------	---

Flasher, starting with the ON time  

E 234 CT-EBD: 7 time ranges (0.05 s- 100 h), 1 c/o contact, 2 LEDs

24-48 V DC, 24-240 V AC		E 234 CT-EBD.12	1SVR 500 150 R0000			0.060	1
----------------------------	--	------------------------	--------------------	--	--	-------	---

Pulse generators  

E 234 CT-TGD: 2x7 time ranges (0.05 s- 100 h)²⁾, 2 c/o contacts, 2 LEDs

24-48 V DC, 24-240 V AC	yes	E 234 CT-TGD.22	1SVR 500 160 R0100			0.065	1
----------------------------	-----	------------------------	--------------------	--	--	-------	---

E 234 CT-TGD: 2x7 time ranges (0.05 s- 100 h)²⁾, 1 c/o contact, 2 LEDs

24-48 V DC, 24-240 V AC	yes	E 234 CT-TGD.12	1SVR 500 160 R0000			0.060	1
----------------------------	-----	------------------------	--------------------	--	--	-------	---

Star-delta change-over 

E 234 CT-SDD: 4 time ranges (0.05 s- 10 min), transition time 50 ms fixed, 2 n/o contacts, 3 LEDs

24-48 V DC, 24-240 V AC		E 234 CT-SDD.22	1SVR 500 211 R0100			0.065	1
----------------------------	--	------------------------	--------------------	--	--	-------	---



E 234 CT-SAD: 4 time ranges (0.05 s- 10 min), transition time adjustable, 2 n/o contacts, 3 LEDs

24-48 V DC, 24-240 V AC		E 234 CT-SAD.22	1SVR 500 210 R0000			0.065	1
----------------------------	--	------------------------	--------------------	--	--	-------	---

²⁾ ON and OFF times adjustable independently,
2x7 time ranges 0.05 s - 100 h

Technical data

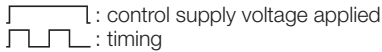
Data at Ta = 25 °C and rated values, if nothing else indicated

Type	CT-D with 1 c/o contact		CT-D with 2 c/o contacts	
Input circuit - Supply circuit				
Rated control supply voltage U _s	A1-A2	24-240 V AC / 24-48 V DC		
	A1-A2	-	12-240 V AC/DC (CT-MFD.21)	
Rated control supply voltage U _s tolerance			-15...+10 %	
Rated frequency	AC/DC versions	DC or 50/60 Hz		
	AC versions	50/60 Hz		
Frequency range	AC/DC versions	DC or 47/63 Hz		
	AC versions	47/63 Hz		
Typical power consumption	24 V DC	0.6 W	on request	
	230 V AC	1.3 VA	on request	
	115 V AC	1.3 VA	on request	
Power failure buffering time	min. 20 ms		min. 30 ms	
Input circuit - Control circuit				
Voltage-related triggering				
Control input, Control function	A1-Y1/B1	start timing external		
Maximum cable length to the control input			50 m - 100 pF/m	
Minimum control pulse length			30 ms	
Control voltage potential			see rated control supply voltage	
Current consumption of the control input	max. 4 mA		on request	
Parallel load / polarized			yes / yes	
Timing circuit				
Time ranges	7 time ranges 0.05 s - 100 h	1.) 0.05-1 s	2.) 0.5-10 s	3.) 5-100 s
		4.) 0.5-10 min	5.) 5-100 min	6.) 0.5-10 h
		7.) 5-100 h		
	4 time ranges 0.05 s - 10 min (CT-SDD, CT-SAD)	1.) 0.05-1 s	2.) 0.5-10 s	3.) 5-100 s
			4.) 0.5-10 min	
Recovery time			< 50 ms	
Repeat accuracy (constant parameters)			Δt < ±0.5 %	
Accuracy within the rated control supply voltage tolerance			Δt < 0.005 % / V	
Accuracy within the temperature range			Δt < 0.06 % / °C	
Star-delta transition time	CT-SDD	fixed 50 ms		
	CT-SAD	adjustable: 20-100 ms in steps of 10 ms		
Star-delta transition time tolerance	CT-SDD, CT-SAD	±3 ms		
Indication of operational states				
Control supply voltage / timing	U: green LED	 : control supply voltage applied : timing		
Relay status	R: yellow LED	 : output relay 1 or 2 energized		
Output circuit				
Kind of output	15-16/18	relay, 1 c/o contact		-
	15-16/18; 25-26/28	-		relay, 2 c/o contacts
	17-18; 17-28			relay, 2 n/o contacts (CT-SDD, CT-SAD)
Contact material			Cd-free, see data sheet	
Rated operational voltage U _e			250 V	
Minimum switching voltage / minimum switching current			12 V / 100 mA	
Maximum switching voltage / maximum switching current			see load limit curves	
Rated operational current I _e (IEC 60947-5-1) for category	AC12 (resistive) at 230 V	6 A	5 A	
	AC15 (inductive) at 230 V	3 A	3 A ①	
	DC12 (resistive) at 24 V	6 A	5 A	
	DC13 (inductive) at 24 V	2 A	3 A ①	
Mechanical lifetime			30 x 10 ⁶ switching cycles	
Electrical lifetime	at AC12, 230 V, 4 A		0.1 x 10 ⁶ switching cycles	
Short-circuit proof / maximum fuse rating (IEC/EN 60947-5-1)	n/c contact	6 A fast-acting		
	n/o contact	10 A fast-acting		

① CT-MFD.2x on request

ABB

Technical data

Data at Ta = 25 °C and rated values, if nothing else indicated

Type	CT-D with 1 c/o contact	CT-D with 2 c/o contacts
General data		
Duty time		100%
Dimensions (W x H x D)	17.5 mm x 70 mm x 58 mm (0.69 x 2.76 x 2.28 inches)	17.5 mm x 80 mm x 58 mm (0.69 x 3.15 x 2.28 inches)
Weight	see ordering details	
Mounting	DIN rail (EN 60715), snap-mounting without any tool	
Mounting position	any	
Minimum distance to other units horizontal / vertical	no / no	
Degree of protection enclosure / terminals	IP50 / IP20	

Electrical connection

Wire size	fine-strand	with wire end ferrule	2 x 0.5-1.5 mm ² (2 x 20-16 AWG) 1 x 0.5-2.5 mm ² (1 x 20-14 AWG)
		without wire end ferrule	2 x 0.5-1.5 mm ² (2 x 20-16 AWG) 1 x 0.5-2.5 mm ² (1 x 20-14 AWG)
	rigid		2 x 0.5-1.5 mm ² (2 x 20-16 AWG) 1 x 0.5-4 mm ² (1 x 20-12 AWG)
Stripping length	7 mm (0.28 inches)		
Tightening torque	0.5-0.8 Nm		

Environmental data

Ambient temperature range	operation	-20 ... +60 °C
	storage	-40 ... +85 °C
Damp heat (cyclic) (IEC/EN 60068-2-30)	6 x 24 h cycles, 55 °C, 95 % RH	
Vibration (sinusoidal) (IEC/EN 60068-2-6)	40 m/s ² , 20 cycles, 10...150...10 Hz	
Shock (half-sine) (IEC/EN 60068-2-27)	100 m/s ² , 11 ms	

Isolation data

Rated impulse withstand voltage U _{imp} between all isolated circuits (VDE 0110, IEC/EN 60664-1)	4 kV; 1.2/50 μs	
Pollution category (IEC/EN 60664-1, VDE 0110, UL 508)	3	
Overvoltage category (IEC/EN 60664-1, VDE 0110, UL 508)	III	
Rated insulation voltage U _i	input circuit / output circuit	300 V
	output circuit 1 / output circuit 2	300 V
Basic insulation (IEC/EN 61140) input circuit / output circuit	300 V	
Protective separation (VDE 0106 part 101 and part 101/A1; IEC/EN 61140)	input circuit / output circuit 250 V	
Test voltage between all isolated circuits (type test)	2.5 kV, 50 Hz, 1 s	

Standards

Product standard	IEC 61812-1, EN 61812-1 + A11, DIN VDE 0435 part 2021	
Low Voltage Directive	2006/95/EC	
EMC Directive	2004/108/EC	
RoHS Directive	2002/95/EC	

Electromagnetic compatibility

Interference immunity	IEC/EN 61000-6-1, IEC/EN 61000-6-2	
electrostatic discharge (ESD)	IEC/EN 61000-4-2	Level 3 (6 kV / 8 kV)
electromagnetic field (HF radiation resistance)	IEC/EN 61000-4-3	Level 3 (10 V/m)
fast transients (Burst)	IEC/EN 61000-4-4	Level 3 (2 kV / 5 kHz)
powerful impulses (Surge)	IEC/EN 61000-4-5	Level 4 (2 kV L-L)
HF line emission	IEC/EN 61000-4-6	Level 3 (10 V)
Interference emission	IEC/EN 61000-6-3, IEC/EN 61000-6-4	
electromagnetic field (HF radiation resistance)	IEC/CISPR 22, EN 55022	B
HF line emission	IEC/CISPR 22, EN 55022	B

Technical diagrams

Load limit curves

AC load (resistive)

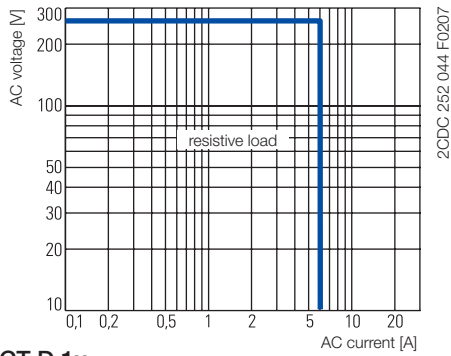

CT-D.1x

DC load (resistive)

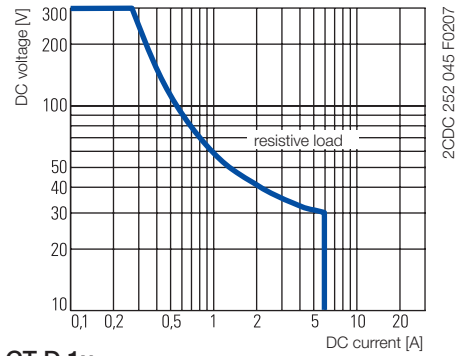

CT-D.1x

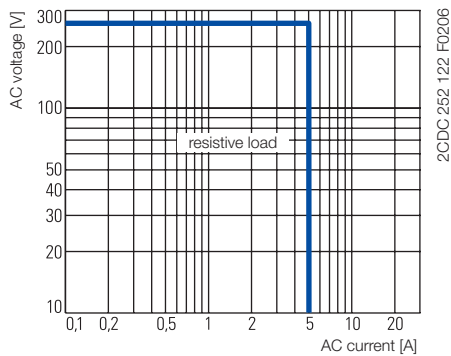

CT-D.2x

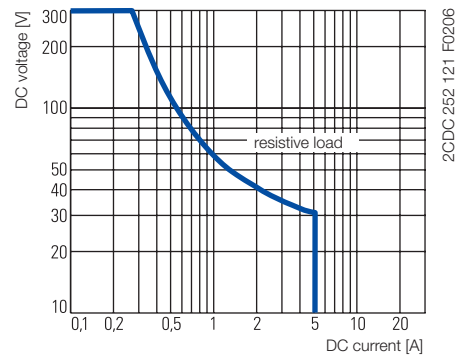

CT-D.2x

Derating factor F

for inductive AC load

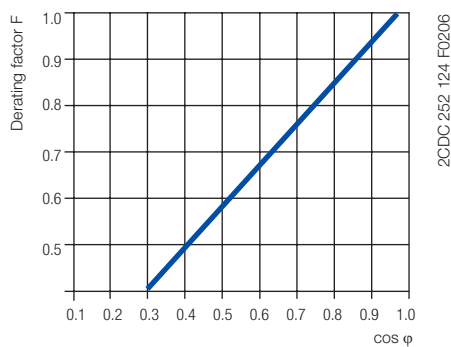

Contact lifetime

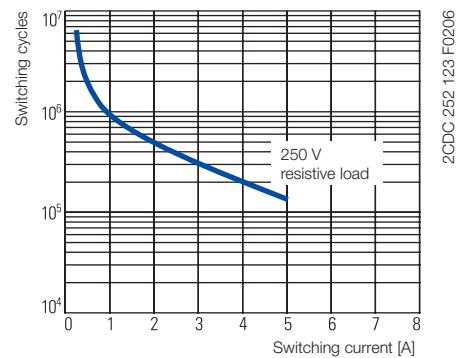

Connection diagrams

CT-MFD.21

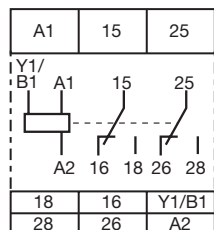

2CDC 252 113 F0b06

CT-MFD.12

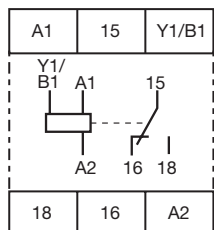

2CDC 252 114 F0b06

CT-ERD.22

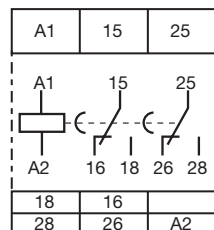

2CDC 252 115 F0b06

CT-ERD.12

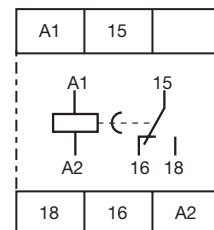

2CDC 252 177 F0b05

CT-AHD.22

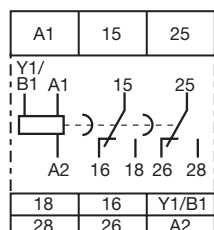

2CDC 252 116 F0b06

CT-AHD.12

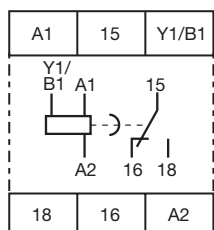

2CDC 252 117 F0b06

CT-VWD.12

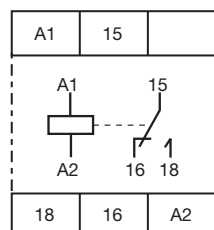

2CDC 252 179 F0b05

CT-EBD.12

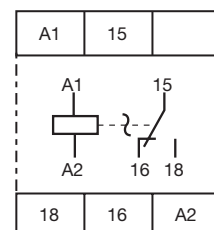

2CDC 252 180 F0b05

CT-TGD.22

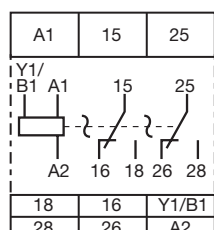

2CDC 252 118 F0b06

CT-TGD.12

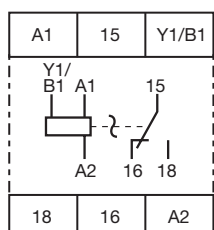

2CDC 252 119 F0b06

CT-SDD.22

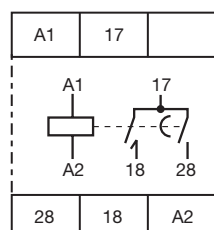

2CDC 252 160 F0b06

CT-SAD.22

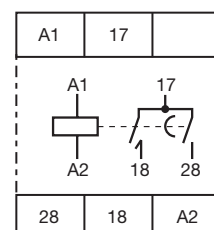

2CDC 252 160 F0b06

Wiring notes for devices with control input

A parallel load to the control input is possible

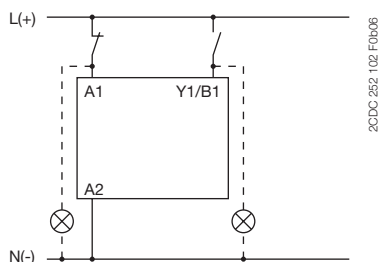

Remarks

Legend

- Control supply voltage not applied / Output contact open
- Control supply voltage applied / Output contact closed
- A1-Y1/B1 Control input with voltage-related triggering

ON-delay
(Delay on make)
CT-ERD, CT-MFD

This function requires continuous control supply voltage for timing. Timing begins when control supply voltage is applied. The green LED flashes during timing. When the selected time delay is complete, the output relay energizes and the flashing green LED turns steady. If control supply voltage is interrupted, the output relay de-energizes and the time delay is reset. Control input A1-Y1/B1 of the CT-MFD is disabled when this function is selected.

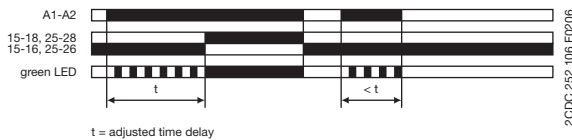

Impulse-ON
(Interval)
CT-VWD, CT-MFD

This function requires continuous control supply voltage for timing. The output relay energizes immediately when control supply voltage is applied and de-energizes after the set pulse time is complete. The green LED flashes during timing. When the selected pulse time is complete, the flashing green LED turns steady. If control supply voltage is interrupted, the output relay de-energizes and the time delay is reset. Control input A1-Y1/B1 of the CT-MFD is disabled when this function is selected.

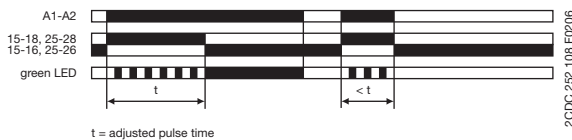

Flasher, starting with the ON time
(Recycling equal times, ON first)
CT-EBD, CT-MFD

Applying control supply voltage starts timing with symmetrical ON & OFF times. The cycle starts with an ON time first. The ON & OFF times are displayed by the flashing green LED, which flashes twice as fast during the OFF time. If control supply voltage is interrupted, the output relay de-energizes and the time delay is reset. Control input A1-Y1/B1 of the CT-MFD is disabled when this function is selected.

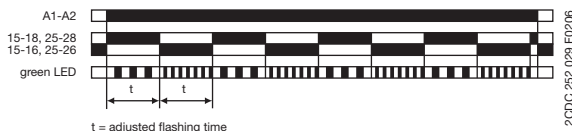

Terminal designations on the device and in the diagrams

- The 1st c/o contact is always designated 15-16/18.
- The 2nd c/o contact is designated 25-26/28.
- The n/o contacts of the star-delta timers are designated with 17-18 and 17-28.
- Control supply voltage is always applied to terminals A1-A2.

Function of the yellow LED

The yellow LED R glows as soon as the output relay energizes and turns off when the output relay de-energizes.

OFF-delay with auxiliary voltage
(Delay on break)
CT-AHD, CT-MFD

This function requires continuous control supply voltage for timing. If control input A1-Y1/B1 is closed, the output relay energizes immediately. If control input A1-Y1/B1 is opened, the time delay starts. The green LED flashes during timing. When the selected time delay is complete, the output relay de-energizes and the flashing green LED turns steady. If control input A1-Y1/B1 recloses before the time delay is complete, the time delay is reset and the output relay does not change state. Timing starts again when control input A1-Y1/B1 re-opens. If control supply voltage is interrupted, the output relay de-energizes and the time delay is reset.

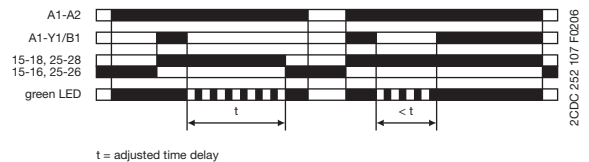

Impulse-OFF with auxiliary voltage
(Trailing edge interval)
CT-MFD

This function requires continuous control supply voltage for timing. If control supply voltage is applied, opening control input A1-Y1/B1 energizes the output relay immediately and starts timing. The green LED flashes during timing. When the selected pulse time is complete, the output relay de-energizes and the flashing green LED turns steady. Closing control input A1-Y1/B1, before the time delay is complete, de-energizes the output relay and resets the time delay. If control supply voltage is interrupted, the output relay de-energizes and the time delay is reset.

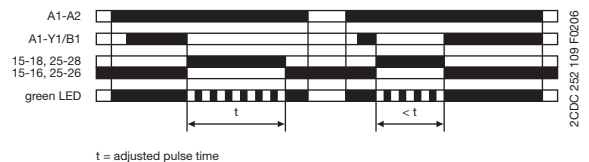

Flasher, starting with the OFF time
(Recycling equal times, OFF first)
CT-MFD

Applying control supply voltage starts timing with symmetrical ON & OFF times. The cycle starts with an OFF time first. The ON & OFF times are displayed by the flashing green LED, which flashes twice as fast during the OFF time. If control supply voltage is interrupted, the output relay de-energizes and the time delay is reset. Control input A1-Y1/B1 of the CT-MFD is disabled when this function is selected.

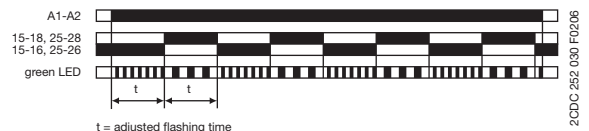

1. Pulse former (Single shot) CT-MFD

This function requires continuous control supply voltage for timing. Closing control input A1-Y1/B1 energizes the output relay immediately and starts timing. Operating the control contact switch A1-Y1/B1 during the time delay has no effect. The green LED flashes during timing. When the selected ON time is complete, the output relay de-energizes and the flashing green LED turns steady. After the ON time is complete, it can be restarted by closing control input A1-Y1/B1. If control supply voltage is interrupted, the output relay de-energizes and the time delay is reset.

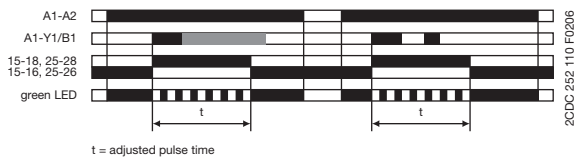

2. Pulse generator, starting with the ON or OFF time (Recycling unequal times, ON or OFF first) CT-TGD

This function requires continuous control supply voltage for timing. Applying control supply voltage, with open control input A1-Y1/B1, starts timing with an ON time first. Applying control supply voltage, with closed control input A1-Y1/B1, starts timing with an OFF time first. The ON & OFF times are displayed by the flashing green LED, which flashes twice as fast during the OFF time. The ON & OFF times are independently adjustable. If control supply voltage is interrupted, the output relay de-energizes and the time delay is reset.

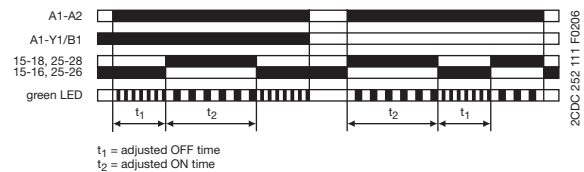

3. Star-delta change-over (Star-delta starting) CT-SDD, CT-SAD

This function requires continuous control supply voltage for timing. Applying control supply voltage to terminals A1-A2, energizes the star contactor connected to terminals 17-18 and begins the set starting time t_1 . The green LED flashes during timing. When the starting time is complete, the first output contact de-energizes the star contactor. Now, the transition time t_2 starts. When the transition time is complete, the second output contact energizes the delta contactor connected to terminals 17-28. The delta contactor remains energized as long as control supply voltage is applied to the unit.

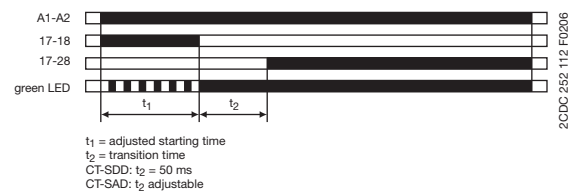

6

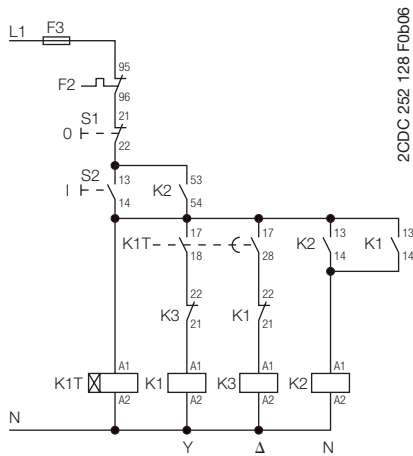

Control circuit diagram

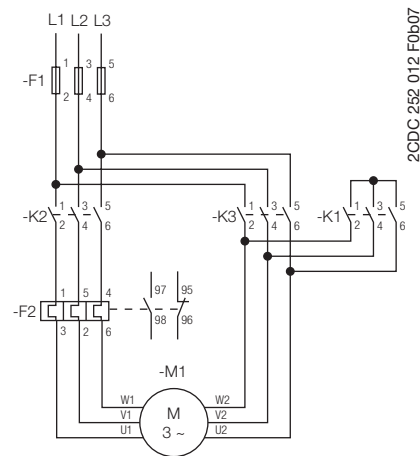

Power circuit diagram



AT electro-mechanical time switches

They control circuit opening and closing according to the scheduled program. Available both on daily and weekly version and equipped with a 16A contact, they can be set on the scheduled program or on the permanent ON function (ON-OFF only for three modules versions). The AT1-R, AT3-R and AT3-7R versions are equipped with a built-in battery, generally charged by the network voltage, which allows the devices to maintain the set time also in case of long (up to 200h) power supply failures. The products fit applications such as shop lighting systems, public buildings, schools, heating and irrigation systems and so forth.

Contacts	Running reserve	Version	Order details	Bbn 8012542	Price 1 piece	Price group	Weight 1 piece	Pack unit
			Type code	Order code	EAN			
						kg	pc.	
1NO	-	daily	AT1	2CSM204205R0601	042051		0,095	1
1NO	200h	daily	AT1-R	2CSM204215R0601	042150		0,095	1
1CO	-	daily	AT3	2CSM204225R0601	042259		0,180	1
1CO	200h	daily	AT3-R	2CSM204235R0601	042358		0,180	1
1CO	200h	weekly	AT3-7R	2CSM204245R0601	042457		0,180	1

Technical features

		AT1	AT1-R	AT3	AT3-R	AT3-7R
Rated supply voltage	[V]	230 AC + 10%				
Contact type		1NO	1NO	1CO	1 CO	1CO
Switching capacity						
resistive load	[A]	16				
inductive load	[A]	4	4	3	3	3
Rated frequency	[Hz]	50-60				
Time base		quartz				
Minimum switching time	[min]	15	15	15	15	120
Max number of commands per cycle		96	96	96	96	84
Running reserve	[h]	-	200	-	200	200
Accuracy		± 1sec / 24h				
Power consumption	[VA]	0.5				
Max. switching power	[W]	4000				
Terminal size for cable	[mm²]	4				
Terminals		loss-proof screw				
Mounting		on DIN rail				
Operating temperature	[°C]	-10...+55				
Storage temperature	[°C]	-10...+55	-10...+55	-20...+70	-10...+55	-10...+55
Modules		1	1	3	3	3
Reference standards		EN 60730-1 ; EN 60730-2-7				

Connection scheme

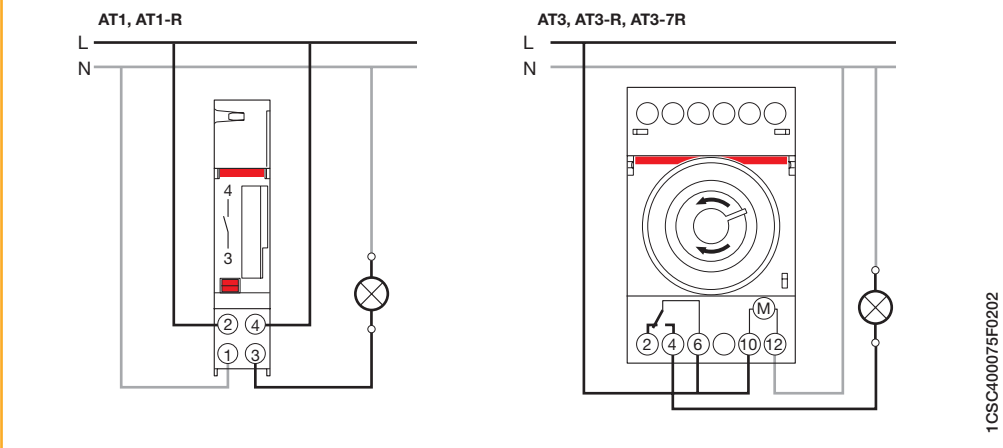

1CSC400075F0202

Programming AT1 - AT1-R

Switching dial

Time setting

Manual override

⌚ = automatic
I = ON permanently

Programming

1CSC400075F0202

Programming AT3 - AT3-R - AT3-7R

Setting the time

Program setting

Manual override

3-position selector:

0 = permanently OFF
⌚ = automatic programmed operation
I = permanently ON.

1CSC400076F0202



AT2 electro-mechanical time switches

The AT2 versions are particularly useful where there is the need to have a complete visibility of the programmable dial in only two modules. They control, as well as the AT1 and AT3 ones, circuit opening and closing according to a scheduled program and are available both on daily and weekly version with a 16A change-over contact. They can be set on the scheduled program or on permanent ON and the versions AT2-R and AT2-7R are equipped with a built-in battery, generally charged by the network voltage, which allows the devices to maintain the set time also in case of long (up to 150h) power supply failures. The products fit applications such as store lighting system, public buildings, schools, heating and irrigation systems and so forth.

Contacts	Running reserve	Version	Order details	Bbn 8012542	Price 1 piece	Price group	Weight 1 piece	Pack unit
			Type code	Order code	EAN			
							kg	pc.
1 CO	-	daily	AT2	2CSM204105R0601	041054		0,118	1
1 CO	150h	daily	AT2-R	2CSM204115R0601	041153		0,118	1
1 CO	150h	weekly	AT2-7R	2CSM204125R0601	041252		0,118	1

Technical features

	AT2	AT2-R	AT2-7R
Rated supply voltage	[V]	230 AC	
Contact type		1 CO	
Switching capacity			
resistive load	[A]	16	
inductive load	[A]	4	
Rated frequency	[Hz]	50-60	
Time base		quartz	
Minimum switching time	[min]	30	210
Max number of commands per cycle		48	
Running reserve	[h]	-	150
Accuracy		± 1sec / 24h	
Power consumption	[VA]	0.5	
Potenza commutabile massima	[W]	3500	
Terminal size for cable	[mm²]	2.5	
Terminals		loss-proof screw	
Mounting		on DIN rail	
Operating temperature	[°C]	-10 ...+50	
Storage temperature	[°C]	-10 ...+50	
Modules		2	
Reference standards		EN 60730-1 ; EN 60730-2-7	

Connection diagram

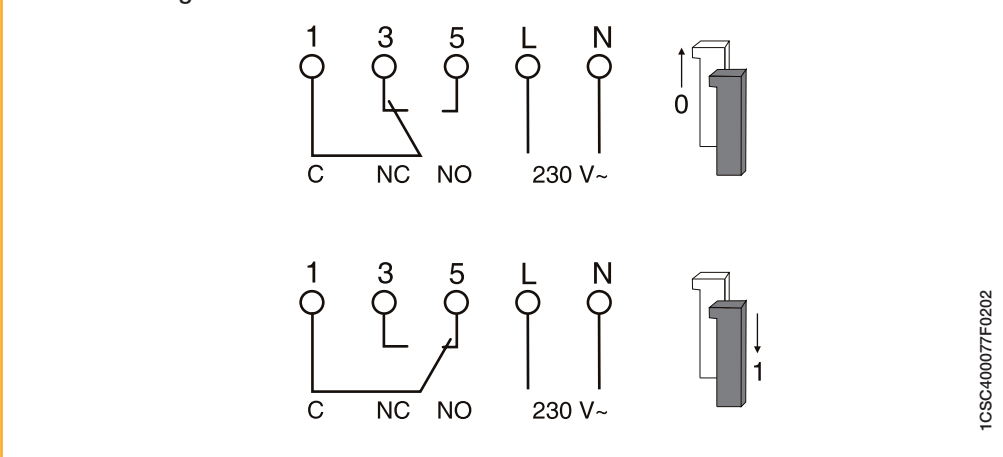

AT2 electro-mechanical time switches

Time setting

AT2 - AT2-R

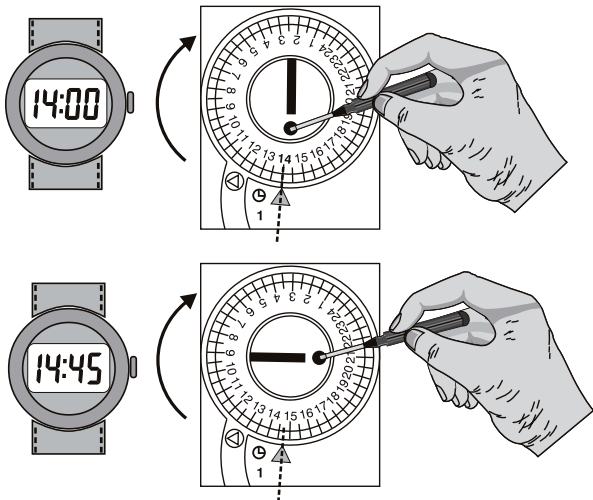

AT2-7R

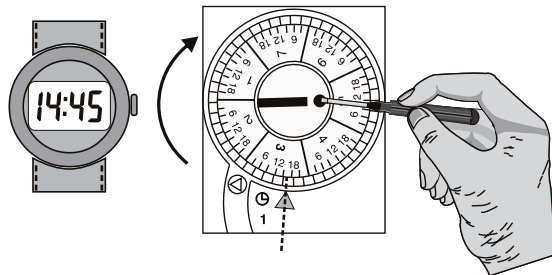

GB Example: 3 = Wednesday 14:45

1CSC400078F0202

6

Programming

Type mode

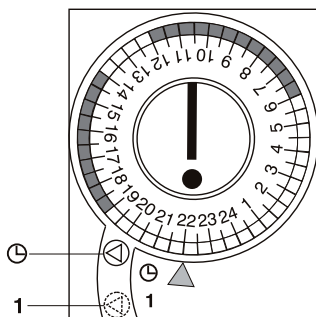

⊖ = Working according to the scheduled program
 1 = Permanent ON

Switching dial

OFF	06:00 ... 12:00	ON
0	12:00 ... 14:00	OFF
1	14:00 ... 19:00	ON
ON	19:00 ... 06:00	OFF

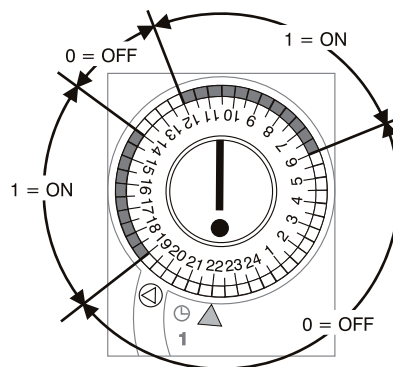

1CSC400079F0202



D Line digital time switches

The unique design, with white backlit LCD display, and extreme ease of use with two lines of text menu and only four buttons, make D LINE ideal to automate the installation functions.

Thanks to the innovative management of time vacation, the D Line digital time switches allow the exclusion of the normal weekly program in one or more periods of several years or between two different years.

The range includes 1 and 2 channel versions, equipped with large capacity internal battery to maintain operation without power supply and permanent memory EEPROM, to avoid the risk of program loss and to maintain the date and time settings in the event of power failure, irrespective of its duration.

The “Plus” version can transfer different type of program by using a D KEY to be quickly copied in No digital time switches, avoiding the errors due to future modification. The “SYNCHRO” version can be coupled to the D DCF77 antenna, that allows an automatic synchronization of the digital time switch with the Frankfurt DCF77 time signal, or can be coupled to the D GPS antenna to allows synchronization received from the Global Positioning System.

The D Line is particularly useful in environments and situations where user management is required with a time schedule flexible enough to predict or exclude activities according to time and day of week or month.

Channels no.	Order details	Bbn	Price	Price	Weight	Pack
	Type code	Order code	1 piece	group	1 piece	unit
					kg	pc.
1	D1	2CSM258763R0621	587637		0.140	1
1	D1 PLUS	2CSM257583R0621	575832		0.140	1
1	D1 SYNCHRO	2CSM257493R0621	574934		0.140	1
2	D2	2CSM256313R0621	563136		0.140	1
2	D2 PLUS	2CSM277583R0621	775836		0.140	1
2	D2 SYNCHRO	2CSM277363R0621	773634		0.140	1

Innovations

Holiday management with the possibility of programming them in various period throughout the year

Product warranty management: the internal clock and battery start at the first installation

Menu programming with 4 simple keys

Minimum switch time is 1 second

Multilingual menu with 11 language choices

Connected load maintenance management: According to the "count down", it sends an alert on the display after a set number of operating hours

Zero load switching to guarantee higher load relay working life.

Load reserves for 6 years from the first start-up guaranteed by the lithium batter

Main features

6

High contrast LCD monitor for excellent visibility in all conditions due to timed back-lighting

Clear display of each contact status

Wide range of programs: standard, cyclic, casual and holiday

GPS or DCF77 signal reception indication

Captive glass with hinge opening

1-2 swapped contact(s)

Occupies the space of 2 DIN modules



1-2 external input(s) for the connection of one or more remote controls, for example: Switches and buttons

1-2 external input(s) for DCF77 or GPS receiver connection (for SYNCHRO)

Permanent or temporary manual deviation, directly activated with a single touch

Sealable glass and keypad lock to prevent tampering by unauthorised personnel.

Programming key slot to run, copy or save programs

Terminals for wires up to 6 mm².

Furthermore, the PLUS and SYNCHRO

D KEY programming key to run programs saved on the key, program transfer from timer switch to key and vice versa to read programs on key.



D SW programming software lets you quickly, simply and easily create complex programs from your desktop. Once created, the program can be printed or saved to file.



The D DCF77 antenna that receives the DCF77 radio synchronisation signal transmitted by the atomic clock installed c/o Mainflingen, near Frankfort, increases digital clock precision.



The GPS antenna that receives time from the Global Positioning System, that offers a more accurate value than land transmissions in addition to the possibility of receiving the signal anywhere in the world.

Technical specifications

		D1	D1 PLUS	D1 SYNCHRO	D2	D2 PLUS	D2 SYNCHRO
Rated voltage	[V]	230 AC ± 10%					
Rated pulsating voltage	[kV]	4					
Contact type		Contact relay in free exchange from potential					
Programming key		-	■	■	-	■	■
External input		-	■	-	-	■	-
DCF77 antenna		-	-	■	-	-	■
GPS antenna		-	-	■	-	-	■
Programming software		-	■	■	-	■	■
250 V contact capacity							
Ohm loads	[A]	16 16					
Inductive loads	[A]	10 2					
Rated frequency	[Hz]	50-60					
Time base		quartz					
Minimum switching	[sec.]	1					
Max programs per cycle	[n°]	64 (can be coupled in day blocks)					
Load reserve	[anni]	6 from the first start-up (lithium battery)					
External input	[n°]	1		-	2		-
Activity suspension		From 1 day to 12 months					
Operating precision	sec./ giorno	± 0.5					
Max. dissipated power	[VA]		6.5			7.8	
Max. switch power	[VA]	3500					
Incandescent LP power	[W]	3000					
Non-rephased fluorescent tube LP power	[W]	1100					
Fluorescent tube LP power rephased in parallel	[W]	900					
Fluorescent tube LP power with electronic reactor	[W]	7 ÷ 23 (max. 23 lamp.)					
Fluorescent tube LP power rephased in series	[W]	1100					
Protection grade	[IP]	20					
Max. terminal section	[mm²]	6					
Terminals		In positive safety with captive screw					
Installation type		DIN rail					
Operating temperature	[°C]	-5 ... +55					
Storage temperature	[°C]	-10 ... +65					
Modules	[n°]	2					

6

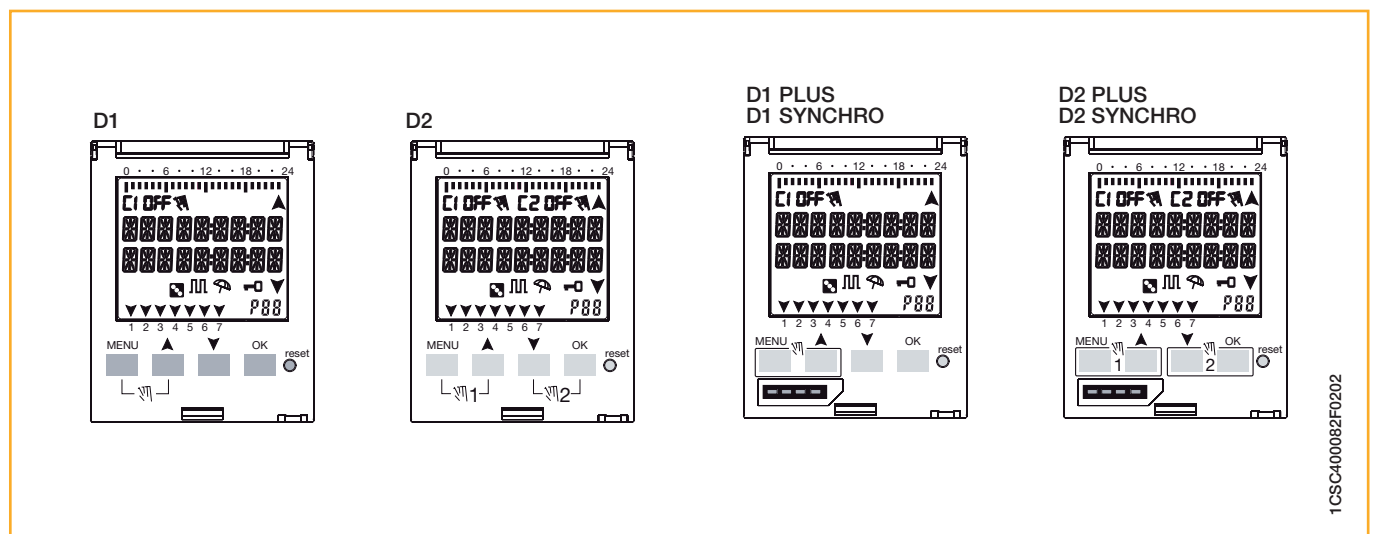

1CSC40002F0202

Programming menu without programming key

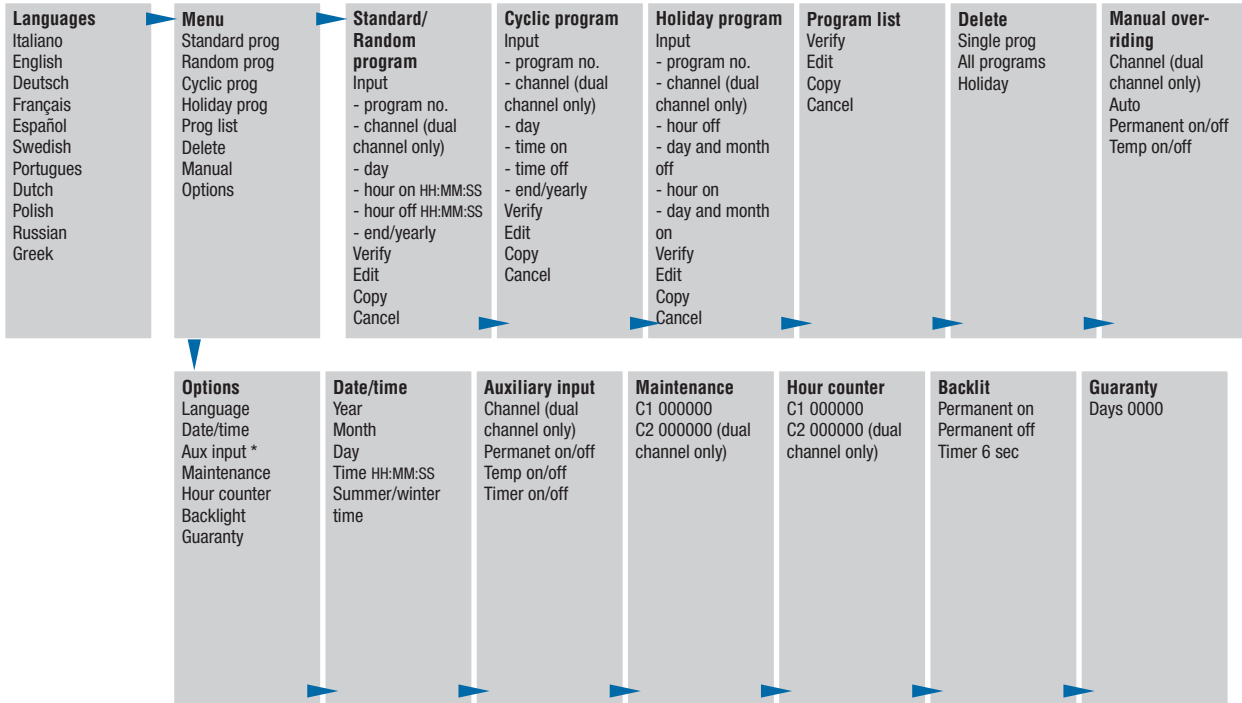

* not allowed for SYNCHRO type

6

Programming menu with programming key

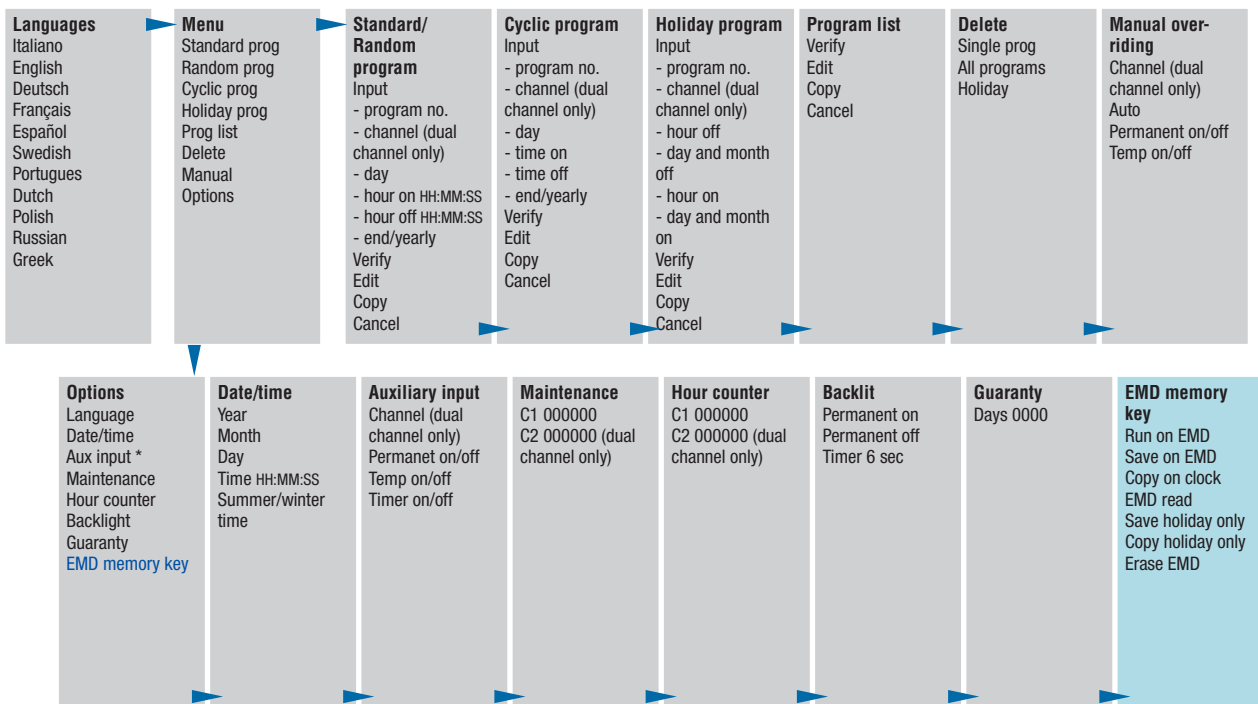

* not allowed for SYNCHRO type

Wiring diagram

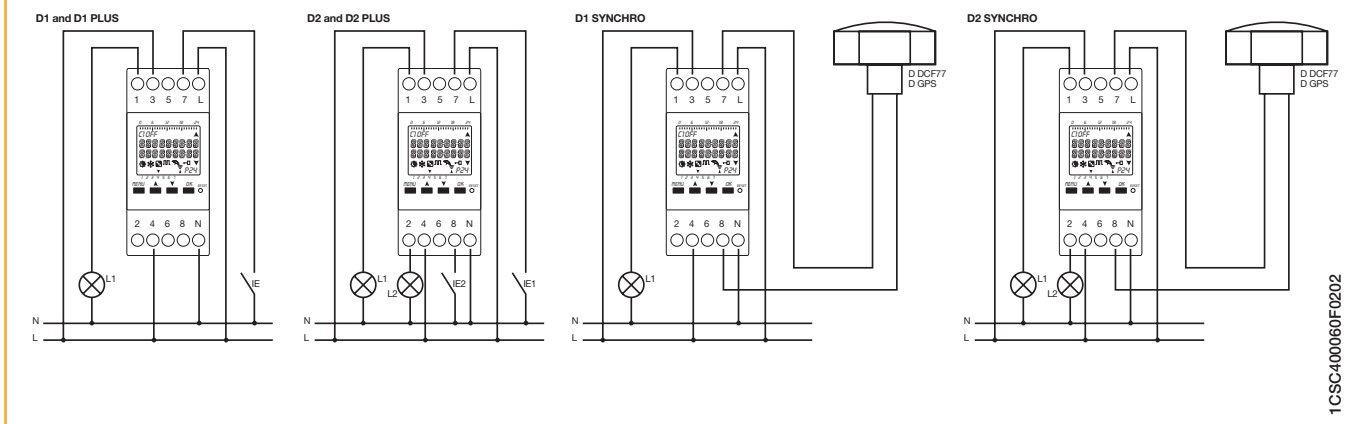

1CSC400060F0202

Accessories for D Line digital time switches



Version	Order details	Bbn 8012542	Price 1 piece	Price group	Weight 1 piece	Pack unit
	Type code	Order code	EAN		kg	pc.
Programming key	D KEY	2CSM277143R0621	771432		0.005	1
Programming software	D SW	2CSM299973R0621	999737		0.020	1
DCF77 antenna	D DCF77	2CSM299983R0621	999836		0.150	1
GPS antenna	D GPS	2CSM299993R0621	999935		0.150	1

6

Technical features

		D DCF77	D GPS
Rated supply voltage	[V]	230 AC ±20%	
Rated frequency	[Hz]	50/60	
Power loss	[W]	0.1	2
Operating temperature	[°C]	-10...+70	-10...+40
Storage temperature	[°C]	-30...+90	-40...+85
Power consumption	[VA]	9.2	2
Time of the signal		1 sending / min.	min 30 sendings/hour ; max 50 sendings/hour
Protection degree	[IP]	65	65
Max. number of connected devices	[No.]	10	10
Max. wiring length	[m]	1000	1000
Terminal size for cable	[mm²]	0.5...2.5	0.5...2.5
Mounting		pole/wall	pole/wall

DCF77 and GPS antenna wirings

The D DCF77 or D GPS antenna allows you to control up to 10 instruments. The polarity of the first instrument is regardless, while the others have to respect the polarity of the first one.

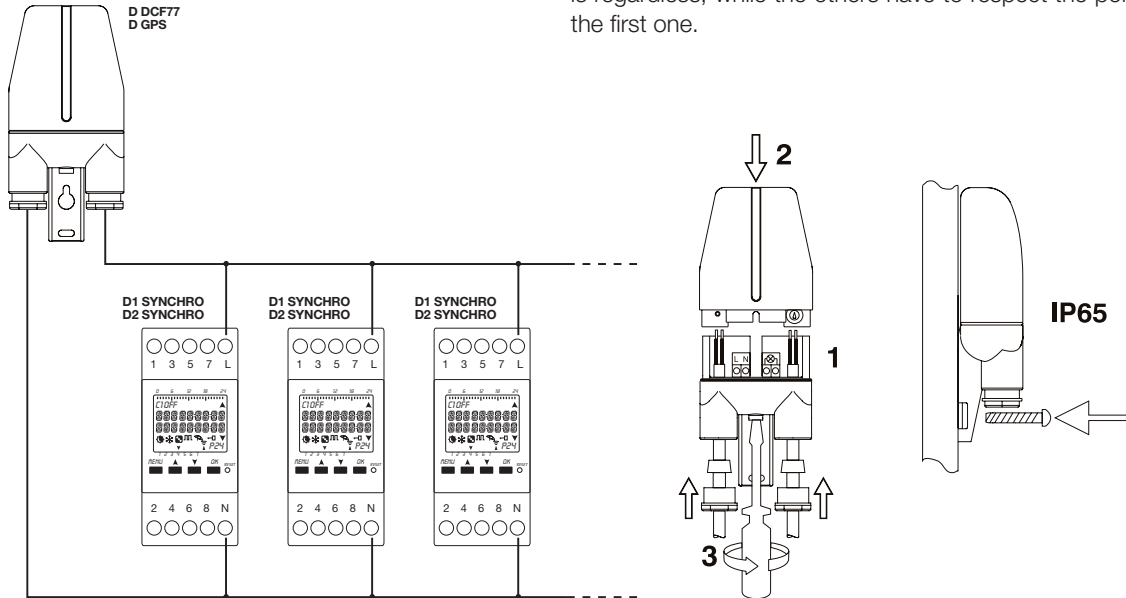

1CSC400084F0202

6

Programming key

Allows to run a program in EMD external memory automatically, to save the programs in the clock or to create programs using the D SW software, on the EMD external memory or viceversa. Furthermore, the holiday programs can be loaded and unloaded on D KEY.

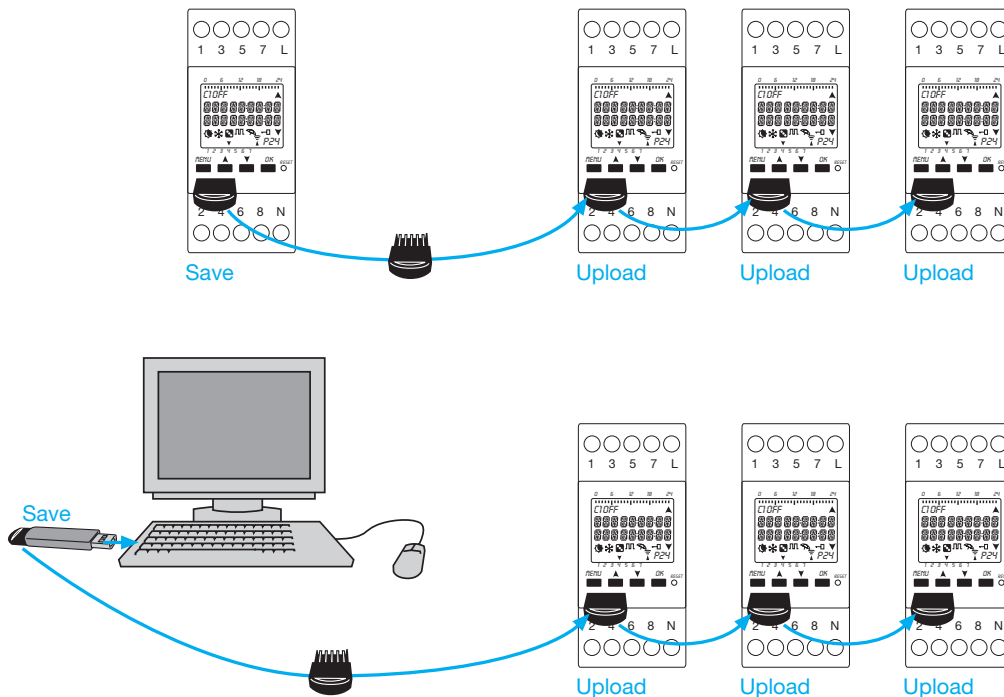

1CSC400085F0202

DCF77 antenna



1CSC400085F0202

Operating principle:

This antenna receives scheduled messages broadcasted from the Frankfurt on Main (Germany) based DCF77 emitter.

Thanks to this signal, the time switches are automatically set to: hour, date and proper daylight saving time.

The broadcast power is 50 kW and the range is approximately 2500 kilometers from Frankfurt on Main.

Sometimes the signal is received intermittently and not in all locations, especially in countries far enough from the D DCF77 emitter.

For optimal signal reception the arrow marked side of the antenna must be rotated towards Frankfurt on Main.

GPS antenna

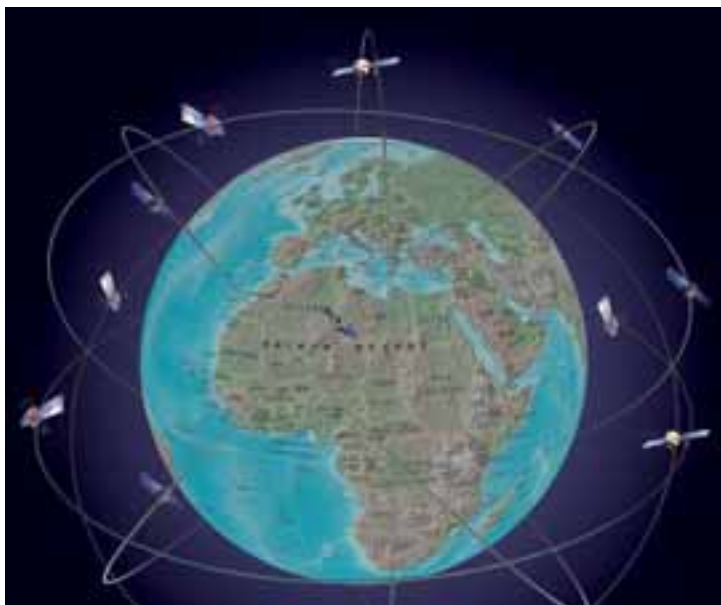

1CSC400086F0202

Operating principle:

The Global Positioning System provides an accurate location and time information for an unlimited number of people in all weather, day or night, anywhere in the world.

The synchronization received from GPS is far more precise regarding to terrestrial broadcast.

The GPS system relies upon time from satellite based atomic clocks, constantly controlled and corrected from a ground stations network.

The time is derived from different sources simultaneously, the digital time switches can automatically compensate for propagation delays and other problems by providing more precise values than terrestrial.



DTS digital time switches

DTS series yearly digital time switches are available in 3 or 4 channel versions. Used for more sophisticated configurations, they are able to control multiple loads or even groups of independent loads that require time-differentiated commands, but with a common clock reference.

An EPROM memory eliminates the risk of program loss in the event of power failure, irrespective of its duration.

DTS yearly digital time switches are ideal in large buildings that have variable needs over the course of the year (public lighting, heating of public buildings, distribution chains, shopping centres, etc...).

Channels	Order details	Bbn	Price	Price group	Unit weight	Pack unit
		8012542	1 piece			
No.	Type	ABB Code	EAN		kg	pc.
3	DTS7/3Y	2CSM133100R0601	507000		0.380	1
4	DTS7/4Y	2CSM134100R0601	538509		0.410	1

Accessories for DTS yearly digital time switches

DTS time switches can be programmed directly from the user's PC using the DTS/PRG-SW software, which allows quick and easy configuration. The program can in fact be transferred from the PC to a portable memory unit, and then copied from there to multiple devices, thus avoiding reprogramming errors.

DTS/PRG-SW software also allows the device to be used as a conventional astronomical time switch. By defining the latitude and longitude of the geographical place of installation, it is possible to automatically control the switching of circuits based on the time when the sun rises and sets.

DTS/DCF antenna, used in conjunction with the device, enables it to be automatically synchronised with the official DCF77 Frankfurt time signal, broadcast via long wave radio. The range of the DCF77 signal is about 2500 km from Frankfurt.

Order details	Bbn	Bbn	Price	Price group	Unit weight	Pack unit
		8012542	1 piece			
Type	ABB code	EAN			kg	pc.
DTS/DCF	2CSM000010R0601	538608			0.230	1
DTS/PRG-SW	2CSM000050R0601	538707			0.350	1

Technical characteristics

	DTS7/3Y	DTS7/4Y
Rated voltage Un	230 AC +10%/-15%	
Contact type	3CO	4CO
Contact capacity		
ohmic loads [A]	16	
inductive loads [A]	2.5	
Rated frequency [Hz]	50/60	
Time reference	quartz	
Minimum ON/OFF setting unit [min]	1	
Max. operations per cycle	400	
Pulse duration	1 sec ... 99 min	
Battery life [years]	6	
Operating accuracy	± 1 sec/day	
Power consumption [W]	5	
Terminals	captive screw	
Installation type	DIN rail	
Protection degree [IP]	20	
Storage temperature [°C]	-25...+55	
Can be sealed	■	
Modules	6	
Standards	EN 60730-1, IEC 730-1, CEI 107-70, VDE0633	

Connection diagram

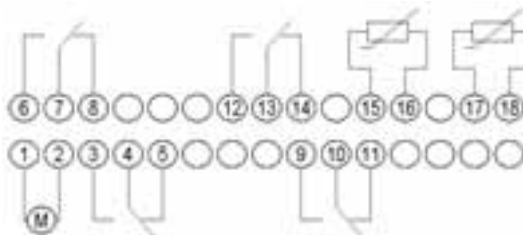

1CSC400086F0202

DTS/PRG-SW: simple installation

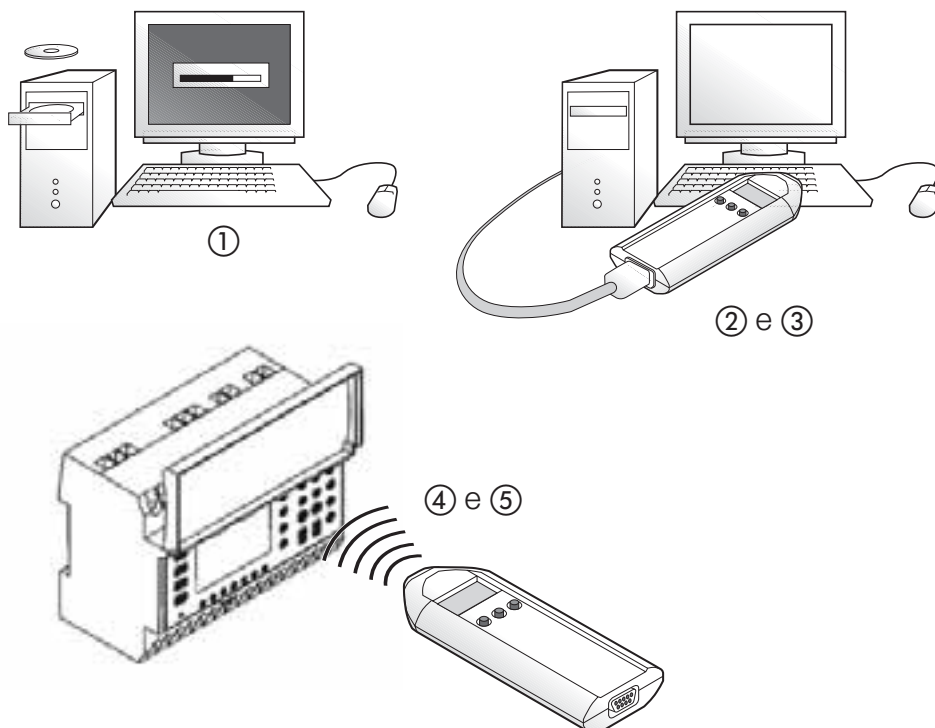

- ① Install the DTS/PRG-SW software on the PC. The system requirements are a 486 processor or higher, with Windows 95/98/2000/NT/XP and at least 4 MB free disk space.
- ② Connect one end of the serial cable to the PC serial port, and the other end to the portable memory unit.
- ③ Using the DTS/PRG-SW software, copy the yearly program from the PC to the portable memory unit.
- ④ Disconnect the portable memory unit and insert it into the infrared slot on the device.
- ⑤ Copy the program from the portable memory unit to the device.

At this point the portable memory unit can be removed from the device and the procedure repeated on another device. In addition to pasting programs onto multiple devices, it is also possible to copy a program from a device to the portable memory unit.

1CSC400087F0202

Removable control panel

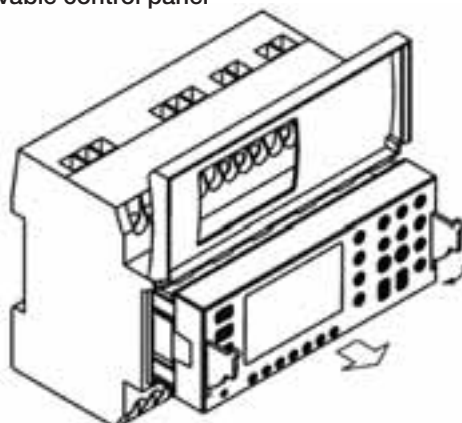

The removable control panel allows the device to be conveniently programmed at the desk.

1CSC400060F0202

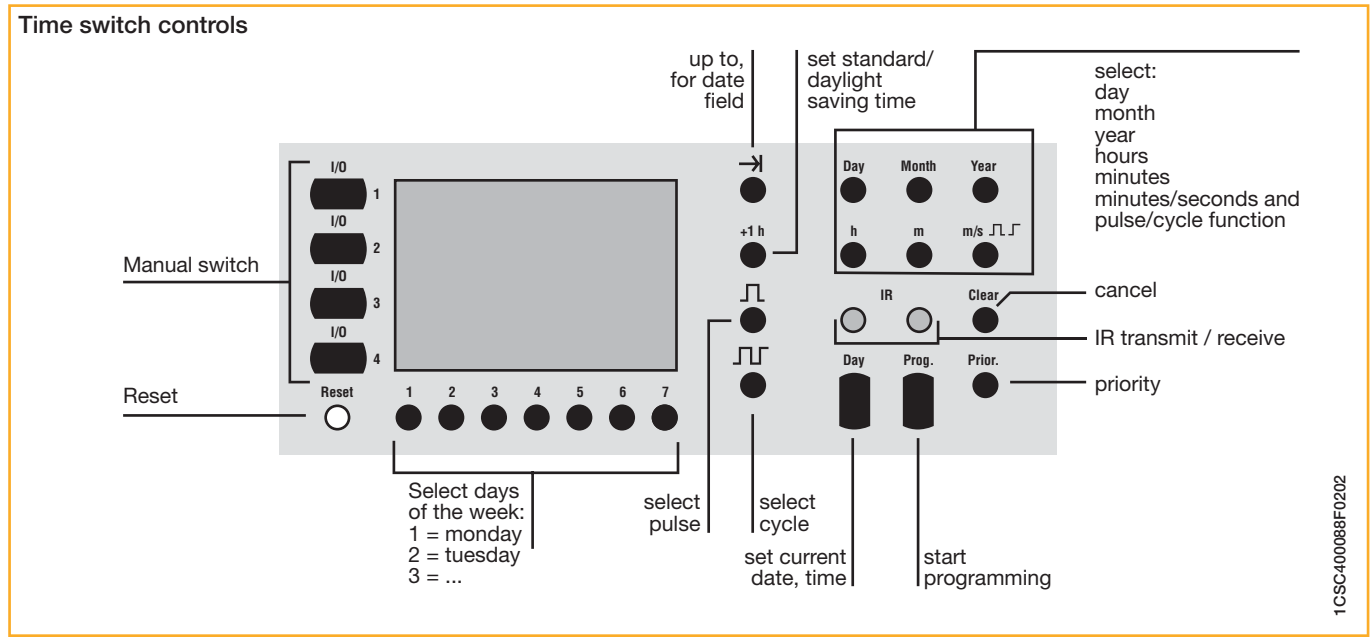

6

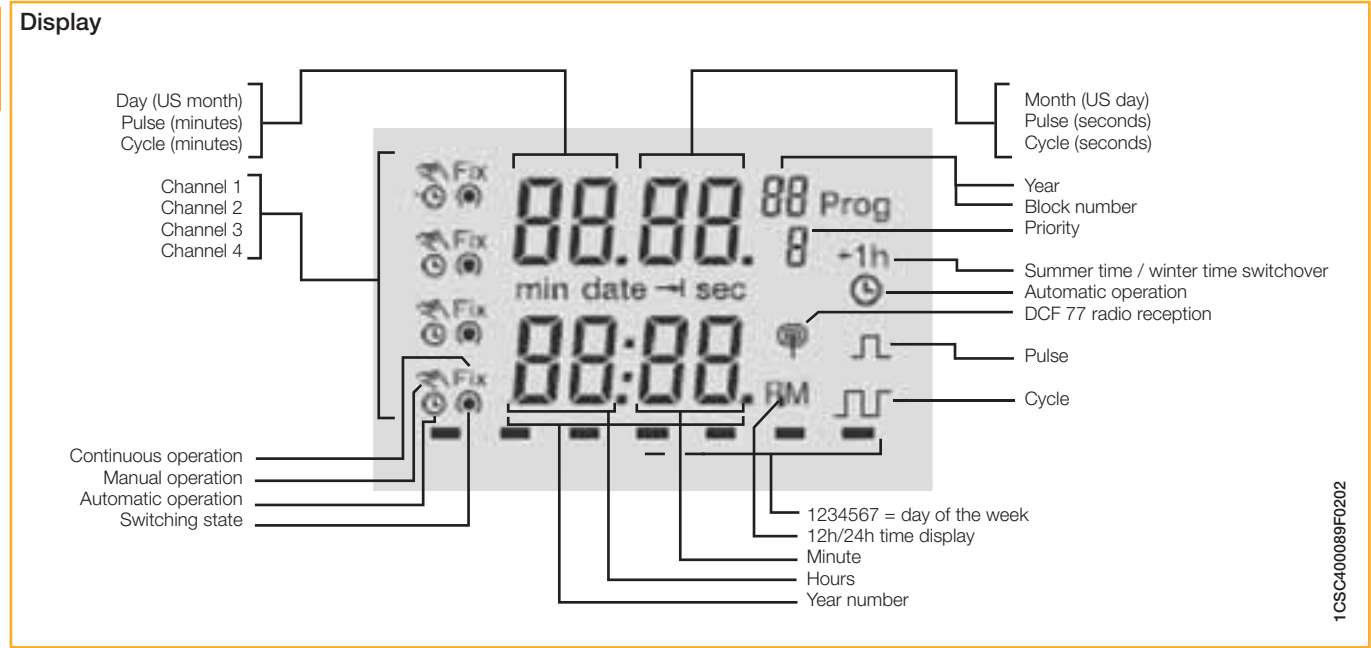

DTS/PRG-SW programming

The DTS/PRG-SW programming software makes it easy to set up a yearly program that can subsequently be copied to the DTS7/3Y or DTS7/4Y digital timers.

Programming in a few easy steps

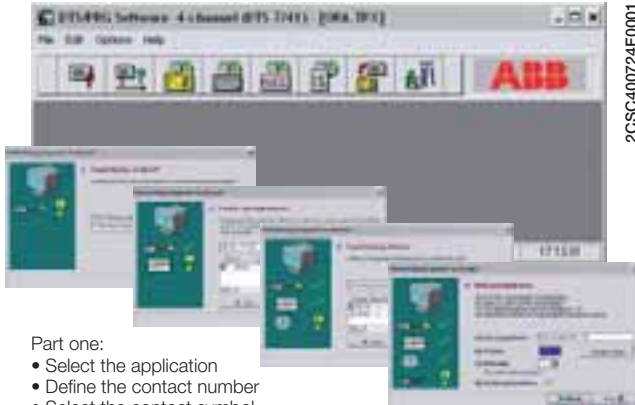

2CSC400724F0001

Part one:

- Select the application
- Define the contact number
- Select the contact symbol
- Define the designations
- Enter the rated power



1CSC400091F0202

Part two:

- Define the program
- Define the contact number
- Define the switching time
- Enter the type of input (ON-OFF, PULSE or CYCLE)
- Add the extra information



The DTS/PRG-SW software can also be used for configuring the astronomical function, for viewing a clear graphical representation of the entire yearly program, with detail access to individual days, as well as for printing a summary of the program to be kept for reference near the installed device or archived.

Astronomical function

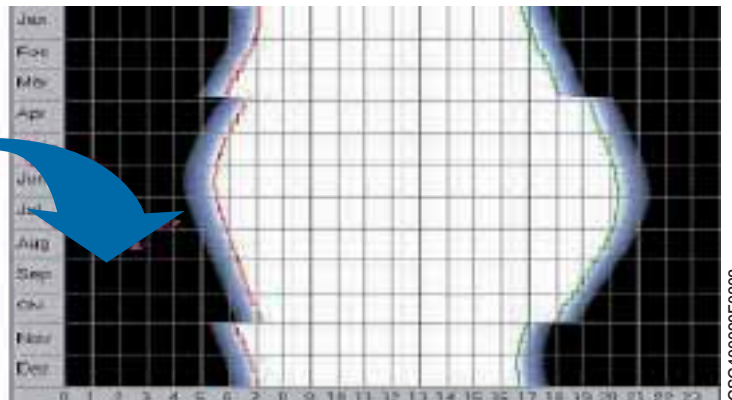

1CSC400090F0202

Using the DTS/PRG-SW software, the DTS7/3Y and DTS7/4Y models can be configured to control one or more contacts based on the sunrise or sunset times of each day of the year, thus replacing the functions of a conventional twilight switch.

The device will start to operate once the date, time and the latitude and longitude of the place of installation have been entered.

The astronomical function is ideal where:

- The distance between the sensor and the time switch is more than 100 m, or if an external sensor cannot be used (panel installed inside a basement...).
- The external sensor cannot be installed away from light sources (amusement parks, campsites,...).
- The external sensor cannot be installed because it is potentially subject to interference from pollution or exposed to vandalism.

Graphical representation



1CSC400092F0202

It is possible to view a clear representation of the yearly program, and of the days and weeks that have been defined. The active parts are highlighted in different colours, as can be seen in the example at left.

Program summary



After setting up and checking the program, it is possible to print out a summary of the program to keep near the installed device or as a reference. The program printout shows the following details:

- Number of switching operations
- Duration of ON and OFF operations
- Pulse duration
- Cycle duration
- Power consumption in kWh (requires correct entry of load values)

E 232 staircase lighting time-delay switches



E 232 staircase lighting time-delay switches

Staircase lighting time-delay switches are usually operated by pushbuttons, often fitted with a glow lamp. Switches are designed for a glow lamp current of up to 150 mA and thus perfectly suitable for installations in multi-storey buildings.

The E 232-230 staircase lighting time-delay switch includes an electro-mechanical timer with a synchronous motor drive to ensure high operational safety in whatever mounting position. The time range is adjustable in increments of 15 seconds from 1 to seven minutes. Resettable after 30 seconds.

E 232E-230N and E 232E-8/230N devices feature electronic time delays. A high switching capacity, 150 mA glow lamp current parallel to the pushbuttons, steplessly adjustable time range from 0.5 to 20 min, as well as low switching noise make these devices so special.

Devices of the E 232E-230 Multi 10 and E 232E-8/230 Multi 10 series are multi-functional products with 10 functions to choose from that can be adjusted from the front. Through an electronically controlled connection of the load at voltage zero, a very high switching capacity of 3,600 W (load of filament lamp) is reached.

The devices include an integrated warning feature (warning by blinking) according to DIN 18015-2 as well as a 60 minute long-time function.

The E 232E-8/230N and E 232E-8/230 Multi 10 staircase lighting time-delay switches offer an additional metallically separated control input for 8...240 V AC/DC.

The electronic E 232-HLM half-light module is a supplementary device for staircase lighting time-delay switches for semi-light control according to DIN 18015-2. The module switches filament lamps and 230 V halogen lamps up to 2,300 W in the warning phase to an output voltage that is reduced by 50%. Adjustable time range from 20 – 60 seconds.

6

Technical features

	E 232-230	E 232E-230N	E 232E-8/230N	E 232E-230 Multi 10	E 232E-8/230 Multi 10	E 232E-HLM
Time range (stepless)	1 – 7 min. in 15 sec. increments	0.5 – 20 min. stepless	0.5 – 20 min. stepless	0.5 – 20 min. stepless	0.5 – 20 min. stepless	20 – 60 sec. stepless
Control voltage 230 V AC	■	■	■	■	■	■
Universal voltage in addition			8 ... 240 V AC/DC		8...240 V AC/DC	
Glow lamp load	50 mA	150 mA	150 mA	150 mA	150 mA	
3/4 conductor operated	switches	automatically	automatically	automatically	automatically	
Resettable	■	■	■	■	■	■
Steady-light switch	■	■	■	■	■	
Advance warning acc. DIN 18015-2				■	■	■
Long-time range of 60 min.				■	■	
Multi-functional device (10 functions)				■	■	
Rated voltage	230 V AC	240 V AC	240 V AC	240 V AC	240 V AC	240 V AC
	50Hz	50 / 60 Hz	50 / 60 Hz	50 / 60 Hz	50 / 60 Hz	50 / 60 Hz
Control voltage range	0.9 ... 1.1 Un	0.85 ... 1.1 Un	0.85 ... 1.1 Un	0.85 ... 1.1 Un	0.85 ... 1.1 Un	0.9 ... 1.1 Un
Power loss	1 VA	6 VA	6 VA	6 VA	6 VA	6 VA
Rated switching capacity	16 A, 230 V AC	16 A, 230 V AC	16 A, 230 V AC	16 A, 230 V AC	16 A, 230 V AC	10 A, 230 V AC
Filament lamp load	2,300 W	2,300 W	2,300 W	3,600 W	3,600 W	2,300 W
Halogen lamp load	2,300 W	2,300 W	2,300 W	3,600 W	3,600 W	2,300 W
Fluorescent lamps series compensated / uncorrected	2,300 VA	2,300 VA	2,300 VA	3,600 VA *	3,600 VA *	not permitted
Fluorescent lamps inductive or capacitive	2,300 VA	2,300 VA	2,300 VA	3,600 VA *	3,600 VA *	not permitted
Fluorescent lamps shunt compensated	1,300 VA (70 µF)	400 VA (42 µF)	400 VA (42 µF)	1,200 VA (120 µF) *	1,200 VA (120 µF) *	not permitted
Electronic controlgear	9x7 W, 6x11 W 5x15 W, 5x20 W	9x7 W, 7x11 W, 7x20 W, 7x23 W	9x7 W, 7x11 W, 7x20 W, 7x23 W	34x7 W, 27x11 W, 24x15 W, 22x23 W	34x7 W, 27x11 W, 24x15 W, 22x23 W	not permitted
Inductive load (cos φ = 0.6/230 V AC)	2,300	2,300	2,300	2,300	2,300	not permitted
Contact material	AgSnO2	AgSnO2	AgSnO2	AgSnO2	AgSnO2	AgSnO2
Contact gap	≥ 3 mm	< 3 mm	< 3 mm	< 3 mm	< 3 mm	< 3 mm
Mech. serviceable life	> 10 ⁵	> 10 ⁷	> 10 ⁷	> 10 ⁷	> 10 ⁷	> 10 ⁷
Serviceable life at rated load, cos φ =1	> 10 ⁵	> 2x10 ⁵	> 2x10 ⁵	> 2x10 ⁵	> 2x10 ⁵	> 10 ⁵
Serviceable life at rated load, cos φ =0.6	> 10 ⁴	> 4x10 ⁴	> 4x10 ⁴	> 4x10 ⁴	> 4x10 ⁴	> 10 ⁴
Terminal capacity	10.7 mm ²	13 mm ²	13 mm ²	13 mm ²	13 mm ²	13.6 mm ²
Max. conductor capacity	6 mm ²	4 mm ²	4 mm ²	4 mm ²	4 mm ²	6 mm ²
ON duration	Resettable after 30 sec.	100 %	100 %	100 %	100 %	100 %
Ambient temperature	- 10 °C to + 50 °C	- 25 °C to + 50 °C	- 25 °C to + 50 °C	- 25 °C to + 50 °C	- 25 °C to + 50 °C	- 10 °C to + 50 °C
Housing and insulation material	heat resistant, self-extinguishing thermoplast	heat resistant, self-extinguishing thermoplast	heat resistant, self-extinguishing thermoplast	heat resistant, self-extinguishing thermoplast	heat resistant, self-extinguishing thermoplast	heat resistant, self-extinguishing thermoplast
Control current at 230 V AC	4.5 mA	26 mA	26 mA	26 mA (min. 8 mA at 8 V AC)	26 mA (min. 8 mA at 8 V AC)	
Minimum command duration	10 ms	20 ms	20 ms	20 ms / 50 ms for multi voltage input	20 ms / 50 ms for multi voltage input	

* no disconnection advance warning possible for this application.



Time range	Power loss W	Order details Type code	Order code	Bbn 4013614 EAN	Price 1 piece	Price group	Weight 1 piece kg	Pack unit pc.
1 ... 7 min.	1 V A	E 232-230	2CDE 110 000 R0501	54824 3			0.081	10
20 min	6 V A	E 232 E-230N	2CDE 110 003 R0511	65416 6			0.095	10
20 min	6 V A	E 232 E-8/230N	2CDE 010 003 R0511	65417 3			0.1	10
20 min	6 V A	E 232 E-230 Multi 10	2CDE 110 013 R0511	65418 0			0.095	10
20 min	6 V A	E 232 E-8/230 Multi 10	2CDE 010 013 R0511	65419 7			0.1	10
20 ... 60 sec.	6 V A	E 232-HLM	2CDE 150 000 R0521	54828 1			0.075	10

E 232E-230 Multi 10, 8/230 Multi 10

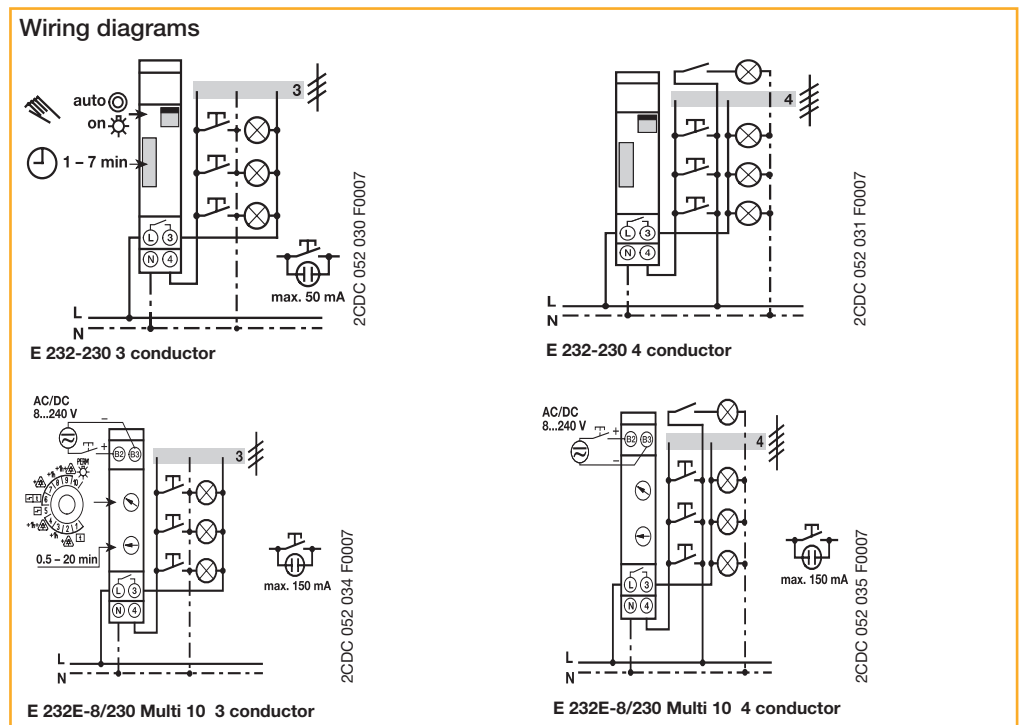
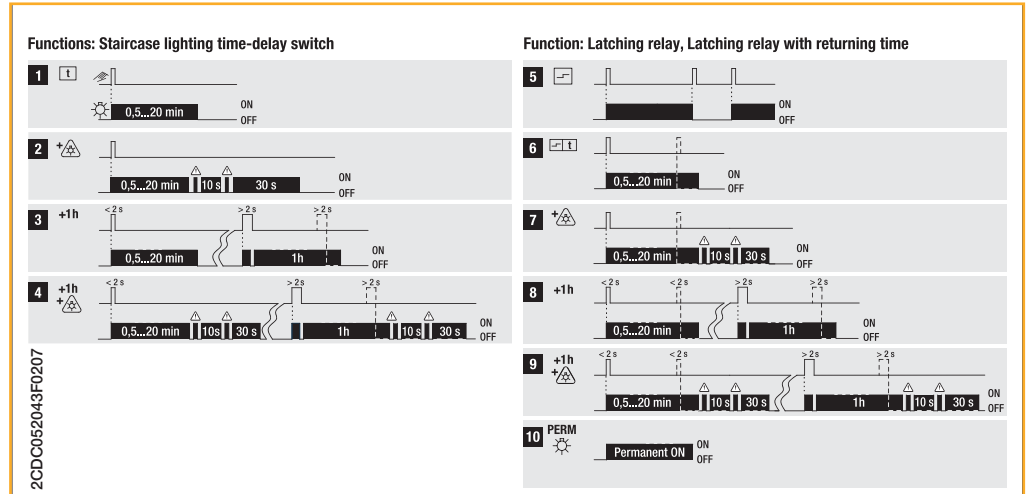

Wiring diagrams

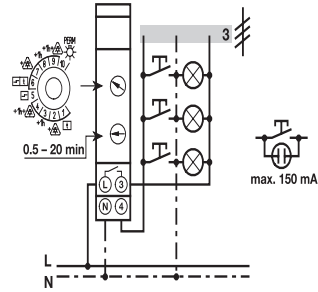

E 232E-230 Multi 10 3 conductor

2CDC 052 032 F0007

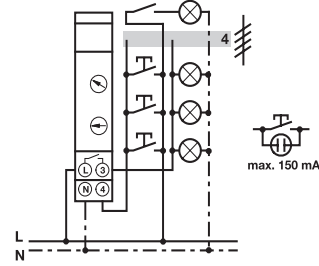

E 232E-230 Multi 10 4 conductor

2CDC 052 033 F0007

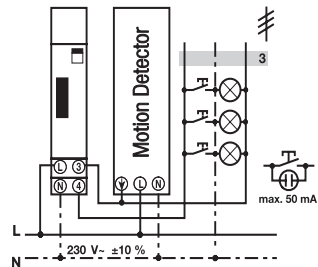

E 232E-8/230 Multi 10 3 conductor
E 232E 8/230 3 conductor
E 232E 230 Multi 10 3 conductor
E 232E 230 N 3 conductor
E 232-230 3 conductor

2CDC 052 037 F0007

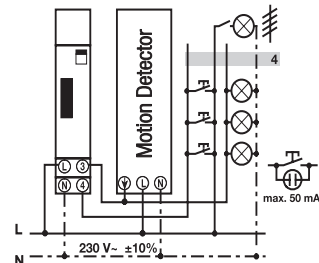

E 232E-8/230 Multi 10 4 conductor
E 232E 8/230 4 conductor
E 232E 230 Multi 10 4 conductor
E 232E 230 N 4 conductor
E 232-230 4 conductor

2CDC 052 039 F0007

Staircase lighting time-delay switches E 232 HLM

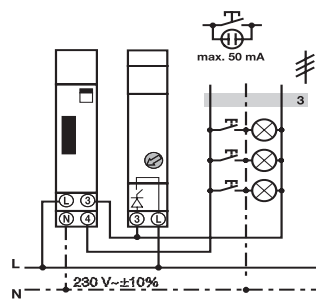

E 232 HLM 3 conductor

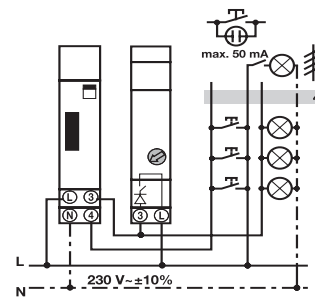

E 232 HLM 4 conductor

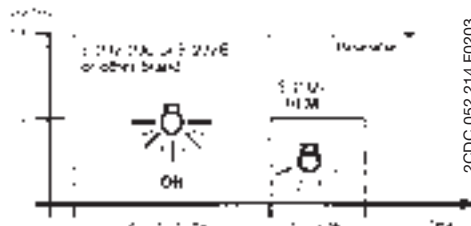

timing of a staircase lighting time-delay switch with semi-light module E 232-HLM

2CDC 052 214 F0203



warning function of E 232E-8/230 Plus

2CDC 052 215 F0203

DIN 18015-2

provides that "that the automatic disconnection of lighting equipment fitted in staircases of apartment buildings must provide for warning signals, e.g. dimming, in order to avoid sudden unexpected darkness".



TW modular twilight switches

They allow to switch on and switch off lighting devices according to a scheduled level of the ambient light. They are used in combination with a sensor to detect if the ambient light is higher or lower than the set level. TW2/10K, equipped with three different types of adjustment range (2:100, 2:1000, 2:10000), fits well the daylight applications where the Lux value is very high. This range, thanks to its features, fits all the applications (for example shop windows and lights) where the rationalization of the energy consumption is required.

Brightness range	Order details	Bbn 8012542	Price 1 piece	Price group	Weight 1 piece	Pack unit
lx	Type code	Order code	EAN		kg	pc.
2 : 100	TW1	2CSM204135R1341	041351		0.107	1
2 : 10.000	TW2/10K	2CSM204145R1341	041450		0.215	1

Accessories for TW modular twilight switches

The photosensor is supplied in the same package of the switch, but it's also available separately as spare part. The upper part of the external case (with screw locking), made up of thermoplastic material, bears up against ultraviolet rays to guarantee an homogeneous diffusion of the daylight internally. The photosensor, wall mounted, is supplied with a cable gland.

Order details	Bbn 8012542	Price 1 piece	Price group	Weight 1 piece	Pack unit
Type code	Order code	EAN		kg	pc.
LS-SP	2CSM204195R1341	041955		0.035	1



Technical features

		TW1	TW2/10K
Rated supply voltage	[V]	230 AC	
Contact type		1NO	1CO
Switching capacity	resistive load [A]	16	
	inductive load cosφ 0.6 [A]	3	
	incandescent lamps cosφ 1	max 960 W	max 1080 W
	fluorescent lamps cosφ 0.8	max 720 W	max 720 W
	fluorescent - duo./electronic lamps cosφ 0.9	max 200 W	max 200 W
Rated frequency	[Hz]	50-60	
Programs ON-OFF		-	-
Switching delay	ON [s]	8 ±10%	8 ±10%
	OFF [s]	38 ±10%	38 ±10%
Brightness range	[lx]	2:100	2:100
			2:1,000
			2:10,000
Accuracy		-	-
Protection degree	twilight switch	IP20	IP20
	sensor	IP65	IP65
Operating temperature	twilight switch [°C]	0...+55	0...+55
	sensor [°C]	-30...+65	-30...+65
Storage temperature	twilight switch [°C]	-10...+65	-10...+65
	sensor [°C]	-40...+75	-40...+75
Power consumption	[VA]	4.5	2.5
Max. commutable power	[W]		3500
Terminal size for cable	[mm²]		2.5
Terminals		loss-proof screw	
Mounting		on DIN rail	
Switching status indication/brightness range		red Led / green Led	
Max wiring length	[m]	100	
Modules		1	2
Reference standards		EN 60669-1 ; EN 60669-2-1	

Connection diagram

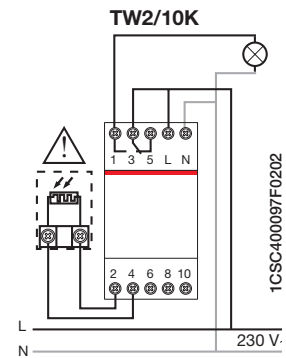
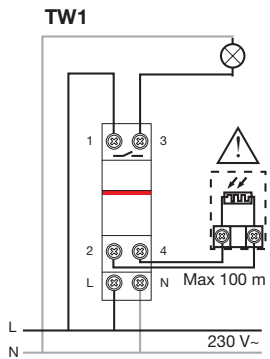

Electrical connection and fixing of the sensor

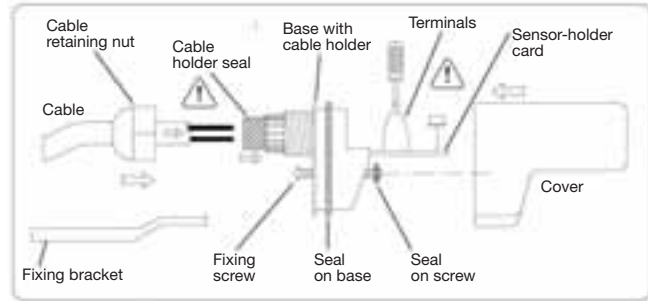
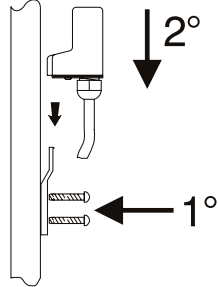

1CSC400098F0202

TW1 and TW2/10K operating principle

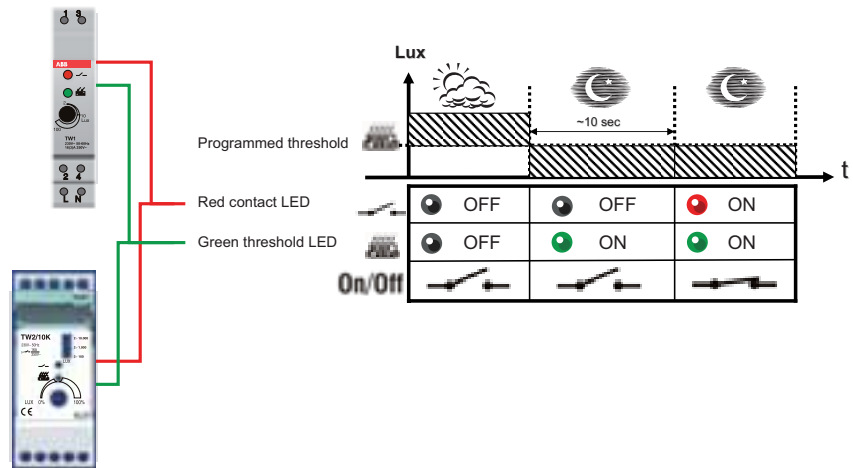

1CSC400098F0202



TWP pole mounting twilight switch

The TWP pole twilight switch, equipped internally with a preset sensor of 10 Lux, is the ideal solution for the management of external light systems such as the public ones. The sensor is extractable from the base and allows an easy and efficient maintenance without needing further wiring.

Brightness range	Order details	Bbn 4016779	Price 1 piece	Price group	Weight 1 piece	Pack unit
lx	Type code	Order code	EAN		kg	pc.
2 : 200	TWP	2CSM204165R1341	041658		0,155	1



Accessory for TWP pole mounting twilight switch

The LS-65 sensor, supplied also individually as spare part, is equipped with internal connections Fast-On which are fast to extract. The sensor, with the upper part of the external case made up of thermoplastic material, bears up against ultraviolet rays to guarantee an homogeneous diffusion of the daylight internally.

LS-65	2CSM204185R1341	041856	0,085	1
--------------	-----------------	---------------	-------	---

Technical features

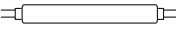
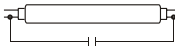
		TWP
Rated supply voltage	[V]	230 AC
Contact type		1NO polarized
Switching capacity		
resistive load	[A]	16
inductive load cosφ 0.6	[A]	3
incandescent lamps	cosφ 1	max 960 W
fluorescent lamps	cosφ 0.8	max 720 W
fluorescent - duo./electronic lamps	cosφ 0.9	max 200 W
Rated frequency	[Hz]	50-60
Switching delay		
ON	[s]	25 ± 10%
OFF	[s]	25 ± 10%
Brightness range	[lx]	2:200
Protection degree		IP65
Operating temperature	[°C]	-30...+60
Storage temperature	[°C]	-30...+65
Power consumption	[VA]	7.5
Max. commutable power	[W]	3500
Terminal size for cable	[mm ²]	2.5
Terminals		screw
Mounting		pole
Switching status indication/ brightness range		- / red Led
Reference standards		EN 60669-1 ; EN 60669-2-1

1CSC40060F0202				
	2300 W (23 x 100 W)	700 W (12 x 58 W)	290 W (5 x 58 W 35 µF)	105 W (7 x 15 W)

Connection diagram

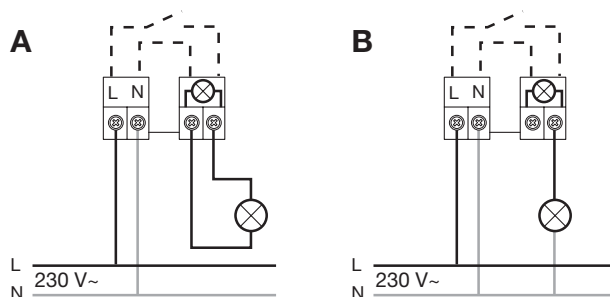

1CSC400097F0202

Setting position

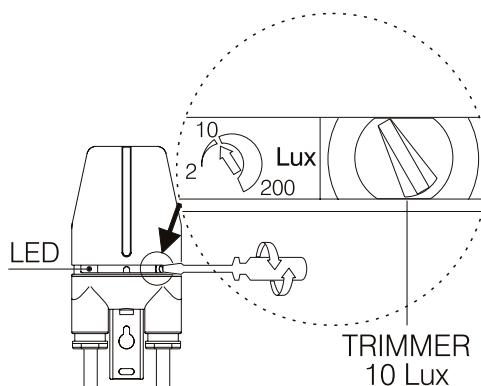

1CSC400084F0202

Mounting

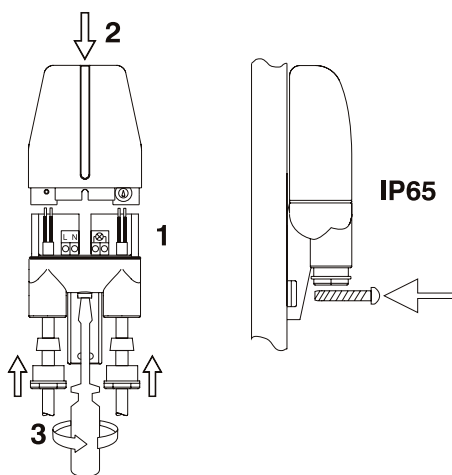

1CSC400084F0202



TWA twilight astronomical switches

They allow to control automatically the light systems according to the hour when the sun rises and sets. The programming is made defining the longitude and latitude parameters of the geographical area where the switch is mounted. Thanks to its features the TWA fits applications such as public lighting system, shop windows, monuments, signs and so forth and particularly when the external sensor is subjected to strong external inconveniences like in area with high level of pollution or in area exposed to vandalic acts.

Contacts	Order details	Bbn	Price	Price group	Weight	Pack unit
Type code	Order code	8012542	1 piece		1 piece	
		EAN			kg	pc.
1 CO	TWA-1	2CSM204365R1341	043652		0,160	1
2 CO	TWA-2	2CSM204375R1341	043751		0,160	1

Technical features

		TWA-1	TWA-2
Rated supply voltage	[V]	230 AC ± 15%	
Contact type		1CO	2 CO
Switching capacity			
resistive load	[A]	16	
inductive load cosφ 0.6	[A]	10	
Max. number of lamps			
incandescent and halogen fluorescent	[W]	2300	
compensated (max. 45µF)	[W]	400	
non-compensated, series compensated	[W]	1000	
compact fluorescent	[W]	500	
Rated frequency	[Hz]	50-60	
Time base		quartz	
Minimum time between two steps	[min]	1	
Program steps		56	
Power reserve	[years]	5	
Accuracy		± 1,5sec / 24h	
Astronomical time accuracy	[min]	± 10	
Power consumption	[VA]	6	
Terminal size for cable		4	
flexible	[mm ²]	1 to 6	
rigid	[mm ²]	1.5 to 10	
Terminals		loss-proof screw	
Mounting		on DIN rail	
Operating temperature	[°C]	-10...+55	
Storage temperature	[°C]	-20...+60	
Protection degree		IP20	
Modules		2	
Reference standards		NFC 15 100; IEC 60 634-1	

6

Connection diagram

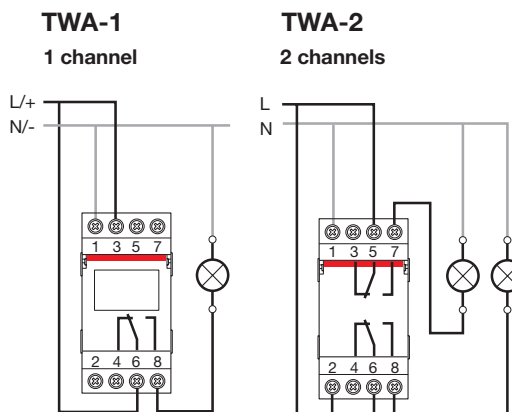

1CSC400097F0202

Keys

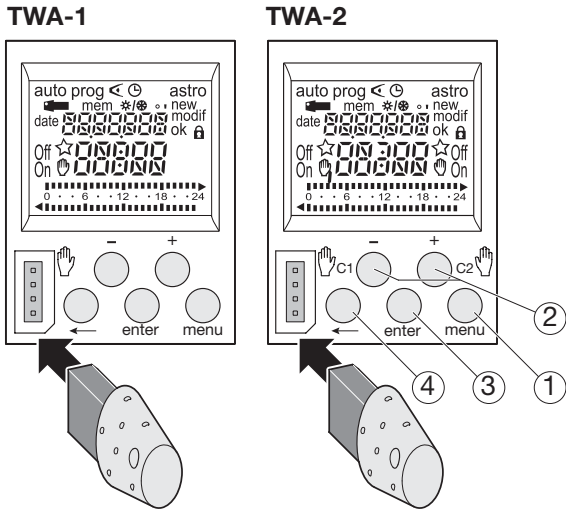

Keys

- ① menu : selection of operating mode.
- auto : mode of running according to the program selected.
- prog : new for programming mode.
- prog : modify to modify an existing program.
- ◀ : checking of the program.
- ⌚ : modification of time, date and selection of the winter/summer timechange mode ⚙️/⚙️
- astro : astronomical mode.
- ☆ : indicates that the channel is in astronomical mode.
- ② + and - : navigation or setting of values.
- ⬅️ - (TWA-1)
- C1 ⬅️, C2 ⬅️ (TWA-2) : in auto mode, selection of overrides, or waivers.
- ③ enter : to validate flashing information on display.
- ④ ← : to return to the previous step.

1CSC400102F0202

6

Programming example

Ex: Rome

- Lo Longitude 12° EAST
- La Latitude 41° NORTH
- UDT +1 Universal Date Time = +1 hour

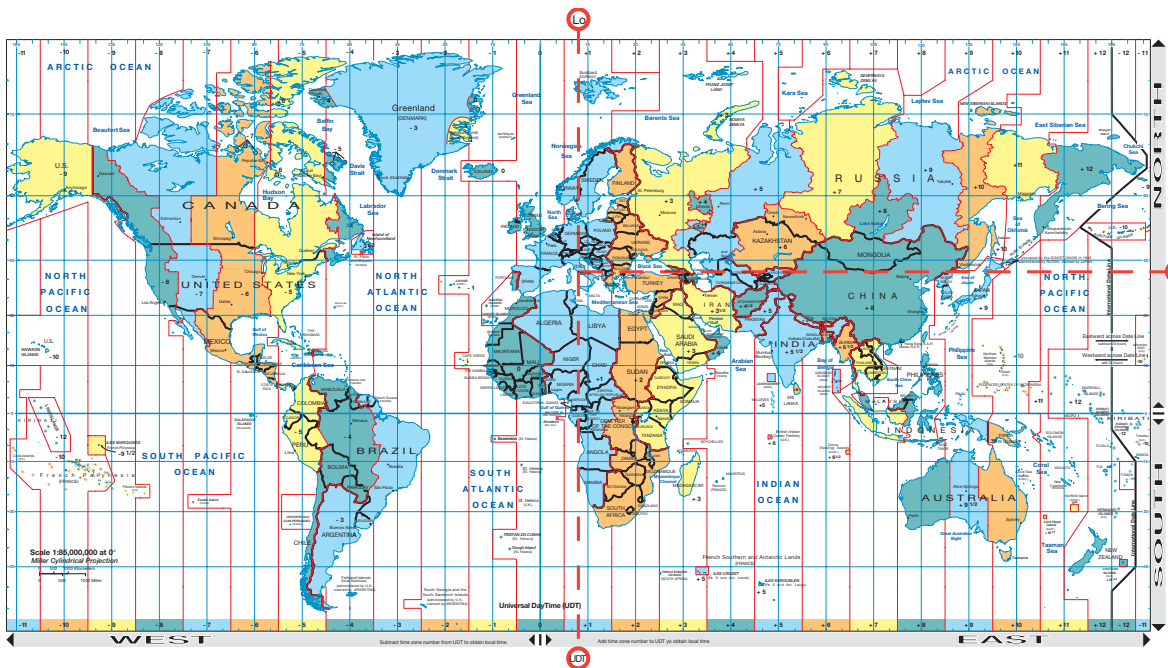
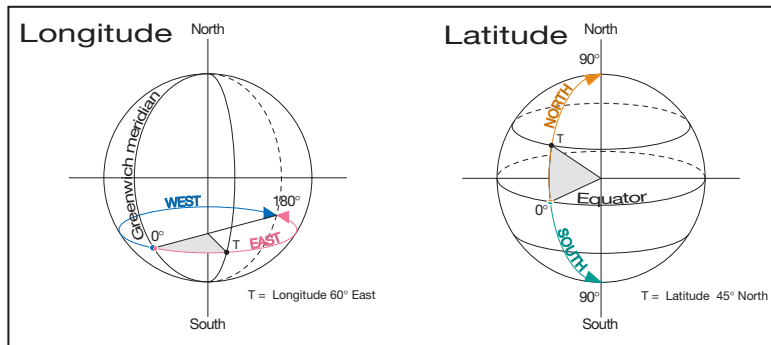

1CSC400103F0202

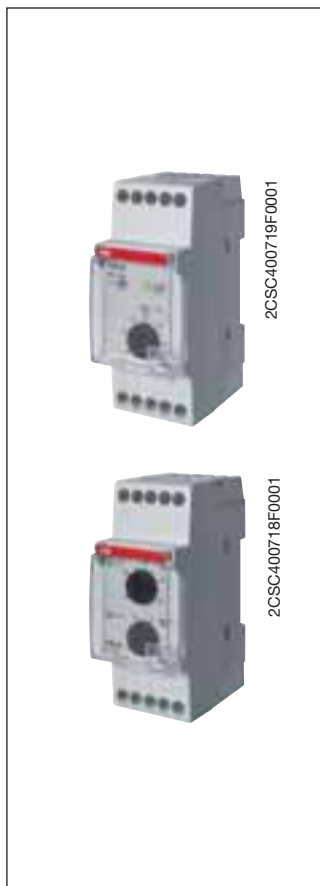

THS modular thermostats

The THS series modular thermostats are suited for a wide array of refrigeration and heating applications. The THS-C and THS-W models, both with a potential-free switching contact, are ideal for controlling temperature in heating systems, industrial settings or difficult-to-access locations, as well as for temperature regulation in refrigeration systems, refrigerated counters, greenhouses, dryers, etc....

The THS-S model, with two independent potential-free contacts, allows regulation of cooling between +20 and +60 °C and anti-condensation between 0 and +10 °C. The THS-S thermostat is supplied with remote sensor and is ideal for temperature control of electrical cabinets.

Temperature °C	Order details Type code	Order code	Bbn 8012542 EAN	Price 1 piece	Price group	Weight 1 piece kg	Pack unit pc.
-20...+40	THS-C	2CSM251163R1380	511632			0.20	1
0...+60	THS-W	2CSM207083R1380	070832			0.20	1
*+20...+60 / 0...+10	THS-S	2CSM236803R1380	368038			0.17	1

* cooling / anticondensation

Temperature sensors for THS-C and THS-W thermostats

The remote sensors (supplied separately) are used in conjunction with the THS-C and THS-W series thermostats to detect temperature overshoot or undershoot from the programmed setpoint. The THS-1 and THS-4 models work in a temperature range between -30 °C and +130 °C and are respectively 1.5 and 4 metres long.

Length m	Order details Type code	Order code	Bbn 8012542 EAN	Price 1 piece	Price group	Weight 1 piece kg	Pack unit pc.
1.5	THS-1	2CSM202033R1380	020332			0.05	1
4	THS-4	2CSM277603R1380	776031			0.12	1

Technical features

	THS-C	THS-W	THS-S
Rated voltage [V]		230 AC	
Type of contact	1 change-over		2NO
Contact capacity			
ohmic load [A]		16	
inductive load cosφ 0.6 [A]		3	
Frequency [Hz]		50-60	
Number of temperature setpoints	1 continuously adjustable		2 continuously adjustable
Adjustment range [°C]	-20...+40	0...+60	0...+10 / +20...+60
Max switching power [W]		3500	
Differential [°C]	fixed Δt = 1		fixed Δt = 2
Thermal gradient	1 °K / 15 minutes		
Type of operation	ON / OFF fixed differential		
Max cable section at terminals [mm²]	2.5		
Protection degree	IP20		
Relay ON/OFF indication	LED indicator		
Temperature tolerance [°C]	±1		
T limits in operation [°C]	0 ÷ +50		0 ÷ +70
Storage temperature [°C]	-10...+65		-10...+70
Type of installation	DIN rail		
Case / color	thermoplastic / grey RAL 7035		
Power consumption [VA]	3		
Application type	services / industrial		
Programming	graduated scale with mechanical pointer		

Connection diagram

THS-C, THS-W

Heating

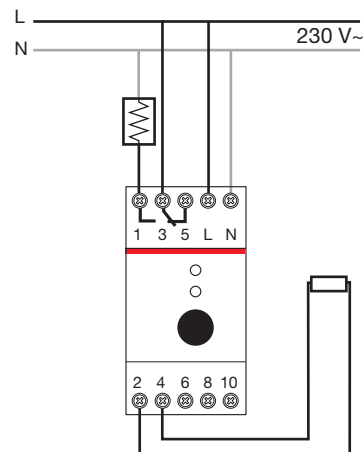

Cooling

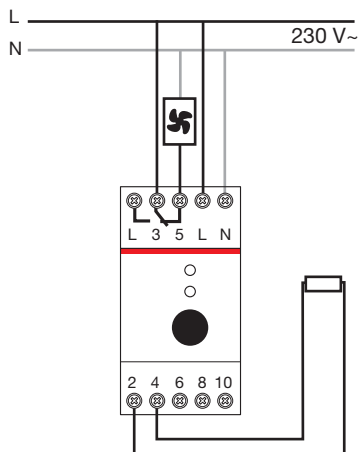

THS-S

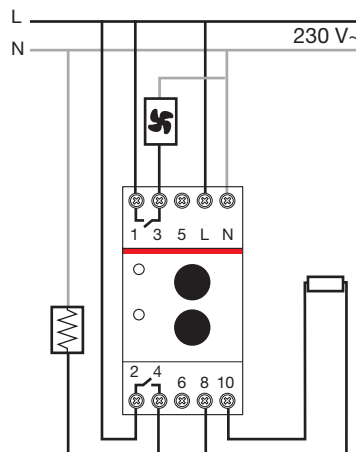

1CSC400106F0202

6

Controls and indicators

THS-C, THS-W

Yellow LED:
"Sensor short-circuit indication"

green LED:
"Load state indication"

Temperature regulation knob
(scale differs depending
on the model)

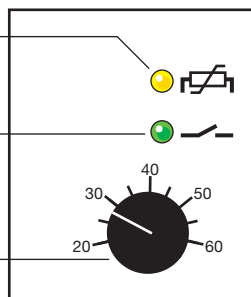

THS-S

Green LED: **cooling**
load state indication

Green LED: **heating**
load state indication

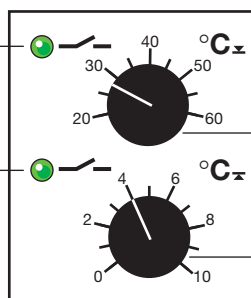

Cooling temperature setpoint knob
Adjustment range: +20°C to +60°C

Heating temperature setpoint knob
Adjustment range: 0°C to +10°C

1CSC400106F0202

Mode of operation

When the THS-C detects a temperature below the programmed setpoint, it closes contact 1 until the temperature returns above the setpoint. It then reopens the contact, and when the temperature again drops below the differential, the cycle is repeated.

THS-W operates in a similar manner, but the relay closes contact 5 when the temperature exceeds the programmed setpoint.

Sensor installation

The THS-1 and THS-4 remote temperature sensors (supplied separately) are waterproof and encapsulated in silicone rubber. They have an operating temperature range between -30°C and +130°C and are respectively 1.5 and 4 meters long.

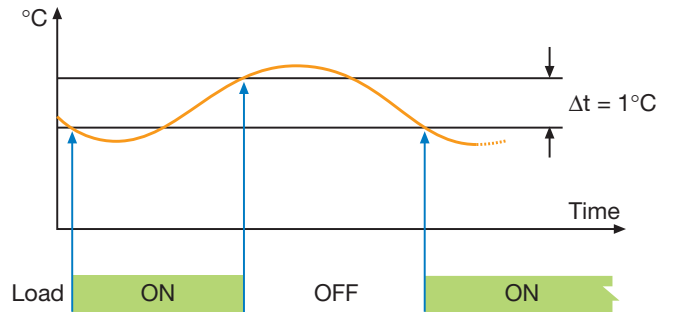

1CSC400107F0202

Mode of operation

As shown in the figure, the THS-S switches on:

- The fan or air conditioner when the temperature in the panel exceeds the maximum setpoint programmed with the upper knob.
- The heating device when the panel temperature falls below the minimum setpoint programmed with the lower knob

Sensor installation

The remote temperature sensor is waterproof and able to withstand temperatures in the range from -30°C to +85°C; it has a maximum connection length of 100m.

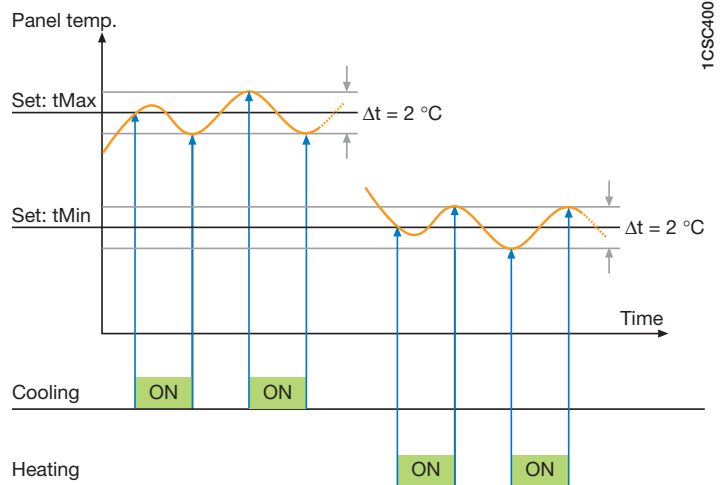

1CSC400107F0202



ATT GSM modules

The ATT modules are GSM telephone actuators for remotely controlling electrical loads over the mobile phone network, which answer the installation requirements of a variety of application settings. In particular, the ATT-22 version consists of a control module with 2 outputs and 2 inputs for residential, services-sector and industrial installations, while the ATT-81 alarm module, with 8 inputs and one output, is suitable for status and alarm monitoring in industrial and services-sector installations. Instructions and alarms can be sent via SMS message, free phone call ring, fax or e-mail according to need. Configuration can be accomplished by SMS messages or using the ATT-Tool software. All the ATT modules are supplied with backup lithium battery, ATT-Tool programming software and PC connecting cable. In addition, the ATT-22E and ATT-81E models are equipped with a pre-wired external antenna – essential if the module is installed in locations that do not assure adequate GSM coverage, such as cellars, enclosed metal structures, etc. The modules can be supplied with an ABB type TS 25/12-24 C modular transformer and are compatible with the GSM SIM cards of all mobile telephone operators.

Inputs	Outputs	Order details		Bbn 8012542	Price 1 piece	Price group	Weight 1 piece	Pack unit
		Type code	Order code	EAN		kg	pc.	
2 analog or digital	2 NO	ATT-22	2CSM322000R1371	944904			0.200	1
8 digital	1 NO	ATT-81	2CSM381000R1371	945000			0.200	1
2 analog or digital	2 NO	ATT-22E	2CSM208345R1371	083450			0.200	1
8 digital	1 NO	ATT-81E	2CSM208355R1371	083559			0.200	1

6

Technical characteristics

GSM module		Dual band EGSM900 and GSM1800 for data, sms, fax and voice applications. Full Type Approved conforming to ETSI GSM Phase 2+
Output power		Class 4 (2 W@900 MHz) Class 1 (1 W@1800 MHz)
Commands sent by		SMS, call rings, DTMF tones, GPRS connection
Incoming alarms		SMS, call rings, e-mail, fax
Inputs	digital	self-powered max. 20 V d.c., 2 mA
	analog (only ATT-22)	input voltage 0...10 V input impedance < 10 Kohm / 100 nF sampling rate 90 Ksps
Outputs	relay	NO 4 A 250 V a.c. - max 2500 VA
	minimum load	100 mA, 12 V
GSM indicator LED	OFF	device not supplied
	STEADY ON	device under power not connected to mobile network, SIM pin code missing or incorrect
	SLOW BLINK	device under power, connected to mobile network
	FAST BLINK	communication in progress
Power supply	[V]	12 ±10% a.c. /d.c.
Power consumption	when transmitting [W]	2.5
	in stand-by [W]	0.4
Terminal section		2.5 mm ²
Temperature	ambient [°C]	-20...55
	storage [°C]	-30...85
Relative humidity	ambient	5...95% non condensing
	storage	5...95% only external condensation
Modules		4
Protection degree		IP40

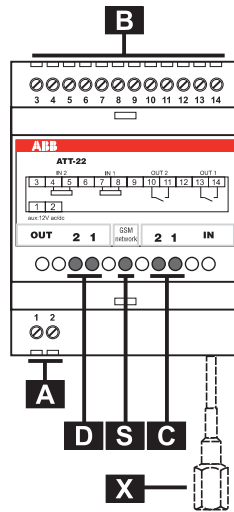

- A:** Power supply input
2x2.5 mm² (AWG14)
- B:** Input and output terminals
14x2.5 mm² (AWG14)
- C:** Red LED, input status indicator
- D:** Green LED, output status indicator
- X:** External antenna (type ATT22-E)
RG174 + FME male jack
- S:** GSM indicator LED

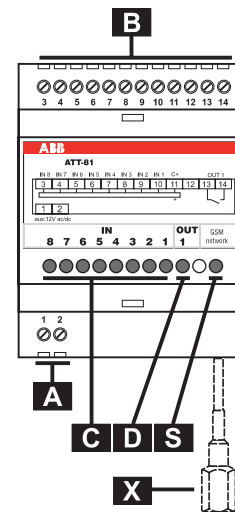

- A:** Power supply input
2x2.5 mm²(AWG14)
- B:** Input and output terminals
14x2.5 mm² (AWG14)
- C:** Red LED, input status indicator
- D:** Green LED, output status indicator
- X:** External antenna (type ATT-81E)
RG174 + FME male jack
- S:** GSM indicator LED



2CDC315039F0506

Concept

CL range logic relays are suitable for small and medium-sized control tasks and are able to substitute logic wiring in a quick and simple manner.

They can be used for applications in control as well as for timing functions, e. g.

- in buildings, lighting systems, air-conditioning systems, general control functions,
- in small machines and systems or
- as stand-alone control module for small applications.

Steps to the application of CL range

- CL range can be used easily, rapidly and comfortably without any time-consuming planning and programming.
- The user can discover the advantages and the benefit of these logic relays in no time at all.
- CL range provides for the control statements according to a simple circuit diagram.
- Setup, storage, simulation and documentation are performed using the compact and user-friendly CL-SOFT software (CL-LAS.PS002).

Software characteristics (CL-SOFT)

- display on a PC monitor according to IEC, ANSI
- up to 10 languages to choose from
- easy installation on all Microsoft Windows™ operating systems

Technical Data overview

Logic relays

- 8 or 12 digital inputs
- 4 or 6 digital relay outputs
- optionally with 4 or 8 transistor outputs
- 128 rungs
- 3 contacts as n/o or n/c contacts in series plus 1 coil per rung
- optionally with 2 or 4 analog inputs (not 100-240 V AC version)
- power flow display for checking the circuit diagram (devices with display)
- expansions for local or remote level
- enclosure color RAL 7035
- DIN rail mounting

Display system

- useable as compact HMI logic relay
- fully graphic, backlit display module
- 12 digital inputs
- 4 digital relay outputs
- optionally with 4 transistor outputs
- 265 rungs
- 4 contacts as n/o or n/c contacts in series plus 1 coil per rung
- optionally with 4 analog inputs (not 100-240 V AC version)
- networking-compatible via CL-NET
- front panel mounting
- expansion for local

Remote display

- Remote display up to a distance of 5 m
- Illustration of text and status displays
- Remote adjustment via keypad
- Front panel mounting

Software

- 16 timing relays 0.01-99:59 h
- 16 counting relays for up-, down counting
- 8 weekly timer, 8 annual timers
- 16 analog value comparators
- 16 freely editable text display
- 32 markers or auxiliary relays

Logic links instead of wiring

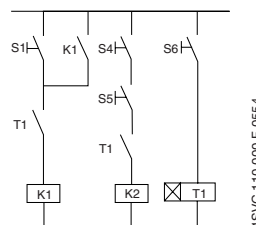

1SVC 110 000 F 0554

Further Documentation

(download from the internet:

www.abb.com/lowvoltage

- Control Products
- Electronic Relays and Controls)

Technical catalogue

Electronic Products

and Relays

2CDC 110 004 C0205

Manuals

Logic relay manual 1SVC 440 795 M0100

Remote display manual 1SVC 440 795 M2100

Display system manual 1SVC 440 795 M1100

System overview

Logic relays

2CDC 312 036 F0b07

- 1a Logic relay CL-LS..
- 1b Logic relay CL-LM..
- 2 Power supply CL-LAS.SD00...
- 3 I/O expansion CL-LER..., CL-LET.. for logic relays CL-LM..
- 4 Coupler unit CL-LEC.. for remote expansion of logic relays CL-LM..
- 5 Memory module CL-LAS.MD003 for logic relays CL-LS., CL-LM..
- 6 Connecting cable CL-LAS.TK001, CL-LAS.TK002 to connect PC
- 7 CL-LINK plug CL-LAS.TK011 to connect expansion to logic relays CL-LM..
- 8a Remote display connection module CL-LDC.S..
- 8b Connecting cable CL-LAD.TK007 to connect a remote displays to a logic relay
- 9 Display module CL-LDD..

Display system □ Compact HMI logic relay

2CDC 312 025 F0b06

- 1 Display module CL-LDD..
- 2 Display base module CL-LDC.LN..
- 3 Display I/O module CL-LDR., CL-LDT..
- 4 Termination resistor CL-LAD.TK009
- 5 I/O expansion CL-LER..., CL-LET..
- 6 Coupler unit CL-LEC.. for remote expansion
- 7 Memory module CL-LAD.MD004 for display base module
- 8 Connecting cable CL-LAD.TK002, CL-LAD.TK003, CL-LAD.TK004
- 9 Connecting cable CL-LAD.TK001, CL-LAD.TK011 to connect PC
- 10 CL-LINK plug CL-LAS.TK011 for expansion of logic relays CL-LM..

■ e.g. door of switchgear cabinet

6

Stand alone with I/O module

2CDC 312 027 F0b06

- 1 Display CL-LDD..
- 2 Remote display connection module CL-LDC.S.. incl. connecting cable
- 3 Display base module CL-LDC.L..

Expansion of logic relays

2CDC 312 037 F0b07

- 1 Logic relay CL-LM..
- 2 I/O expansion CL-LER..., CL-LET..
2a local expansion
2b remote expansion
- 3 Coupler unit CL-LEC.. for remote expansion of logic relays CL-LM..
- 4 CL-LINK plug CL-LAS.TK011 for expansion of logic relays CL-LM..
- 5 up to 30 m

Communication via CL-NET

2CDC 312 026 F0b06

- 1 Display CL-LDD..
- 2 Display base module CL-LDC.LN.. for CL-NET
- 3 Display I/O module CL-LDR., CL-LDT..
- 4 Connecting cable CL-LAD.TK002, CL-LAD.TK003, CL-LAD.TK004
- 5 Termination resistor CL-LAD.TK009

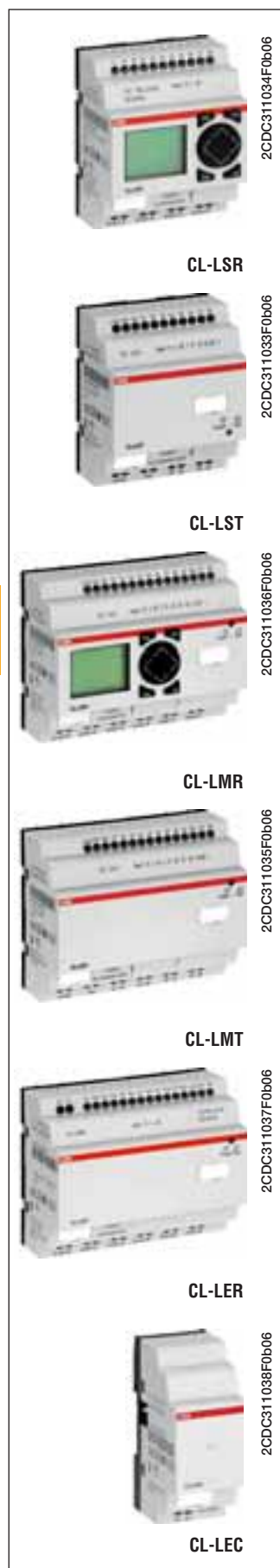

Type	Rated operational voltage	Display + Keypad	Timer	Expandable	Order code	Pack. unit pieces	Price 1 piece	Weight 1 piece kg/lb
Logic relays – 8 inputs, 4 relay outputs								
CL-LSR.C12AC1	24 V AC	• •			1SVR 440 712 R0300	1		0.20/0.44
CL-LSR.CX12AC1	24 V AC		•		1SVR 440 712 R0200	1		0.20/0.44
CL-LSR.12AC2	100-240 V AC	•			1SVR 440 713 R0100	1		0.20/0.44
CL-LSR.C12AC2	100-240 V AC	• •			1SVR 440 713 R0300	1		0.20/0.44
CL-LSR.CX12AC2	100-240 V AC		•		1SVR 440 713 R0200	1		0.20/0.44
CL-LSR.C12DC1	12 V DC	• •			1SVR 440 710 R0300	1		0.20/0.44
CL-LSR.CX12DC1	12 V DC		•		1SVR 440 710 R0200	1		0.20/0.44
CL-LSR.12DC2	24 V DC	•			1SVR 440 711 R0100	1		0.20/0.44
CL-LSR.C12DC2	24 V DC	• •			1SVR 440 711 R0300	1		0.20/0.44
CL-LSR.CX12DC2	24 V DC		•		1SVR 440 711 R0200	1		0.20/0.44
Logic relays – 8 inputs, 4 transistor outputs								
CL-LST.C12DC2	24 V DC	• •			1SVR 440 711 R1300	1		0.20/0.44
CL-LST.CX12DC2	24 V DC		•		1SVR 440 711 R1200	1		0.20/0.44
Logic relays – 12 inputs, 6 relay outputs								
CL-LMR.C18AC1	24 V AC	• • •			1SVR 440 722 R0300	1		0.36/0.79
CL-LMR.CX18AC1	24 V AC		• •		1SVR 440 722 R0200	1		0.36/0.79
CL-LMR.C18AC2	100-240 V AC	• • •			1SVR 440 723 R0300	1		0.36/0.79
CL-LMR.CX18AC2	100-240 V AC		• •		1SVR 440 723 R0200	1		0.36/0.79
CL-LMR.C18DC1	12 V DC	• • •			1SVR 440 720 R0300	1		0.36/0.79
CL-LMR.CX18DC1	12 V DC		• •		1SVR 440 720 R0200	1		0.36/0.79
CL-LMR.C18DC2	24 V DC	• • •			1SVR 440 721 R0300	1		0.36/0.79
CL-LMR.CX18DC2	24 V DC		• •		1SVR 440 721 R0200	1		0.36/0.79
Logic relays – 12 inputs, 8 transistor outputs								
CL-LMT.C20DC2	24 V DC	• • •			1SVR 440 721 R1300	1		0.36/0.79
CL-LMT.CX20DC2	24 V DC		• •		1SVR 440 721 R1200	1		0.36/0.79
Expansion – 2 relay outputs								
CL-LER.20	-				1SVR 440 709 R5000	1		0.07/0.15
Expansions – 12 inputs, 6 relay outputs								
CL-LER.18AC2	100-240 V AC				1SVR 440 723 R0000	1		0.26/0.57
CL-LER.18DC2	24 V DC				1SVR 440 721 R0000	1		0.22/0.49
Expansion - 12 inputs, 8 transistor outputs								
CL-LET.20DC2	24 V DC				1SVR 440 721 R1000	1		0.21/0.46
Coupler unit for remote expansion with a distance of up to 30 m								
CL-LEC.CI000	-				1SVR 440 709 R0000	1		0.07/0.15



2CDC311012F0b07

CL-LAS.PS002

2CDC311013F0b07

CL-LAS.MD003

2CDC311014F0b07

CL-LAS.TK001

2CDC311031F0b07

CL-LAS.TK011

2CDC311016F0b07

CL-LAS.SD..

2CDC311017F0b07

CL-LDC.S..

Type	Description	Order code	Pack. unit pieces	Price 1 piece	Weight 1 piece kg/lb
Software CL-SOFT for programming and control of CL range devices					
CL-LAS.PS002	Installation CD-ROM for Microsoft Windows™	1SVR 440 799 R8000	1		0.10/0.21
Memory module for logic relays					
CL-LAS.MD003	Memory size: 32 kB	1SVR 440 799 R7000	1		0.02/0.04
Connecting cable with serial interface to connect PC and logic relay					
CL-LAS.TK001	Length: 2 m	1SVR 440 799 R6000	1		0.10/0.22
Connecting cable with USB interface to connect PC and logic relay					
CL-LAS.TK002	Length:	1SVR 440 799 R6100	1		
Connecting cable for point-to-point connection of remote-display connection module and logic relay					
CL-LAD.TK007	Length: 5 m, adaptable	1SVR 440 899 R6600	1		0.20/0.44
Fixing brackets for screw mounting of logic relay, expansion, display base module					
CL-LAS.FD001	content: 9 fixing brackets	1SVR 440 799 R5000	1		0.01/0.01
Connecting plug CL-LINK for connection of logic relay to expansion					
CL-LAS.TK011	CL-LINK	1SVR 440 799 R5100	1		0.10/0.22
Input-/ output simulator with wall power supply, fits to CL-LSR and CL-LST					
CL-LAS.TD001	100-240 V AC 24 V DC	1SVR 440 793 R0000	1		0.19/0.43
Primary switch mode power supplies					
CL-LAS.SD001	100-240 V AC 24 V DC / 0.35 A 12 V DC / 20 mA	1SVR 440 703 R0000	1		0.10/0.22
CL-LAS.SD002	100-240 V AC 24 V DC / 1.25 A	1SVR 440 713 R0000	1		0.20/0.44
Graphic display modules 132 x 64 pixel					
CL-LDD.XK	without keyboard	1SVR 440 839 R4500	1		0.14/0.30
CL-LDD.K	with keyboard	1SVR 440 839 R4400	1		0.13/0.29
Remote display connection modules to displace the display from the logic relay, incl. connecting cable CL-LAD.TK007, 5 m, length adaptable					
CL-LDC.SDC2	24 V DC	1SVR 440 841 R0000	1		0.16/0.36
CL-LDC.SAC2	100-240 V AC	1SVR 440 843 R0000	1		0.16/0.36



CL-LDD.K

2CDC311028F0b06



CL-LDC.LN..

2CDC311031F0b06



CL-LDR

2CDC311032F0b06

Type	Rated operational voltage	Order code	Pack. unit pieces	Price 1 piece	Weight 1 piece kg/lb
Grafic Display modules 132 x 64 pixel					
CL-LDD.XK	without keyboard	1SVR 440 839 R4500	1		0.14/0.30
CL-LDD.K	with keyboard	1SVR 440 839 R4400	1		0.13/0.29
Display base modules - CPU / power supply					
CL-LDC.LDC2	24 V DC	1SVR 440 821 R0000	1		0.16/0.36
CL-LDC.LAC2	100-240 V AC	1SVR 440 823 R0000	1		0.16/0.36
Display base modules - CPU / power supply, networking-compatible (CL-NET)					
CL-LDC.LNDC2	24 V DC	1SVR 440 821 R1000	1		0.17/0.38
CL-LDC.LNAC2	100-240 V AC	1SVR 440 823 R1000	1		0.17/0.38
Display I/O modules - 8 inputs, 4 relay outputs					
CL-LDR.16AC2	100-240 V AC	1SVR 440 853 R0000	1		0.17/0.38
CL-LDR.16DC2	24 V DC	1SVR 440 851 R0000	1		0.17/0.38
Display I/O modules - 8 inputs, 4 relay outputs, 1 analog output					
CL-LDR.17DC2	24 V DC	1SVR 440 851 R2000	1		0.17/0.38
Display I/O module - 8 inputs, 4 transistor outputs					
CL-LDT.16DC2	24 V DC	1SVR 440 851 R1000	1		0.14/0.30
Display I/O module - 8 inputs, 4 transistor outputs, 1 analog output					
CL-LDT.17DC2	24 V DC	1SVR 440 851 R3000	1		0.14/0.30



2CDC311018F0b07

CL-LAD.MD004



2CDC311021F0b07

CL-LAD.TK009

Type	Description	Order code	Pack. unit pieces	Price 1 piece	Weight 1 piece kg/lb
Memory module for display base modules					
CL-LAD.MD004	Memory size: 256 kB	1SVR 440 899 R7000	1		0.02/0.03
Connecting cable with serial interface to connect PC and display base module					
CL-LAD.TK001	Length: 2 m	1SVR 440 899 R6000	1		0.11/0.23
Connecting cable with USB interface to connect PC and display base module					
CL-LAD.TK011	Length:	1SVR 440 899 R6700	1		
Network cable (CL-NET) to connect 2 display base modules					
CL-LAD.TK002	Length: 0.3 m	1SVR 440 899 R6100	1		0.05/0.12
CL-LAD.TK003	Length: 0.8 m	1SVR 440 899 R6200	1		0.07/0.14
CL-LAD.TK004	Length: 1.5 m	1SVR 440 899 R6300	1		0.08/0.18
Connecting cable for point-to-point connection of remote display connection modules and display base module					
CL-LAD.TK005	Length: 5 m, adaptable	1SVR 440 899 R6400	1		0.20/0.44
Connecting cable for point-to-point connection of 2 display base modules, length adaptable					
CL-LAD.TK006	Length: 5 m	1SVR 440 899 R6500	1		0.12/0.26
Termination resistor					
CL-LAD.TK009	content: 2 pieces	1SVR 440 899 R6900	1		0.01/0.02
Protective covers, transparent					
CL-LAD.FD001	for harsh environmental conditions and application in the food industry	1SVR 440 899 R1000	1		0.03/0.07
CL-LAD.FD011	sealable	1SVR 440 899 R2000	1		0.03/0.07
Assembly tool for mounting of display modules					
CL-LAD.FD002	-	1SVR 440 899 R3000	1		

Modular devices in the load management devices category react automatically to variations of parameters and other events in the system to allow plant optimization.

- **E 450** priority switches: the priority switch disconnects the long-term load as long as the short-term consumer is switched on.
- **RAL** overload relays: they monitor the power consumption in the system and signals if the threshold value is reached
- **LSS1/2** load shedding switch: it switches off a maximum of two non-prioritary loads when the preset threshold of power consumption is exceeded
- **SQZ3** phase and sequence relay: it performs the continue monitoring in three-phases networks for the phase sequence, phase failure, minimum voltage.
- **E 236** undervoltage monitoring relays control the three-phase undervoltage (each phase to neutral) of switchgear.

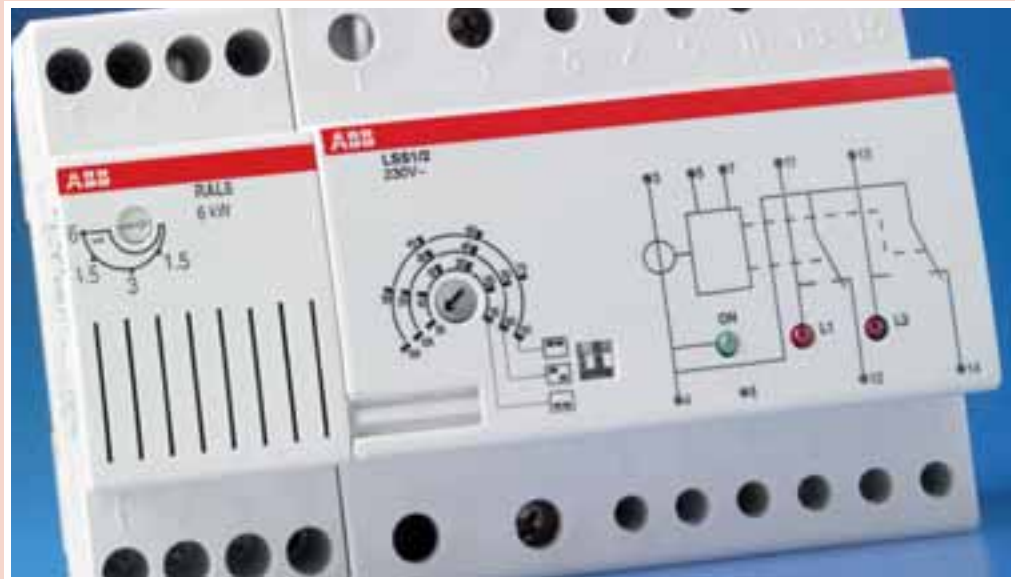



Index

Selection tables

E 450 priority switches	7/2
RAL overload relays	7/4
LSS1/2 load shedding switch.....	7/6
E 235 mains disconnection relays.....	7/8
SQZ3 phase and sequence relay	7/9
RH/RL Maximum and minimum current/voltage relays	7/10
E 236 undervoltage monitoring relays.....	7/12
LEE 230 extractable power failure signalling lamp.....	7/15



E 450 priority switches

The priority switch is used in wiring systems where existing lead cross sections or the size of the power supply service box do not allow for simultaneous operation of two powerful loads (e.g. storage heating and flow-type heater).

The priority switch disconnects the long-term load (storage heating) for as long as the short-term consumer (flow-type heater) is switched on.

The coil of the priority switch is connected in series to the short-term load. When this load is switched on, the NC contact of the priority switch disconnects e.g. the heating system contactor.

Rated current range	Power loss	Order details		Bbn 4016779	Price 1 piece	Price group	Weight 1 piece	Pack unit
	W	Type code	Order code	EAN			kg	pc.

For pneumatically controlled flow-type heaters

6,7 ... 39 A	2.4	E 451- 5.7 A	2CDE160000R0901	41590 3			0.1	10
--------------	-----	--------------	-----------------	---------	--	--	-----	----

For electronically controlled flow-type heaters

6,7 ... 39 A	2.4	E 452-5.7 A	2CDE160010R0901	20950 2			0.1	10
--------------	-----	-------------	-----------------	---------	--	--	-----	----

7

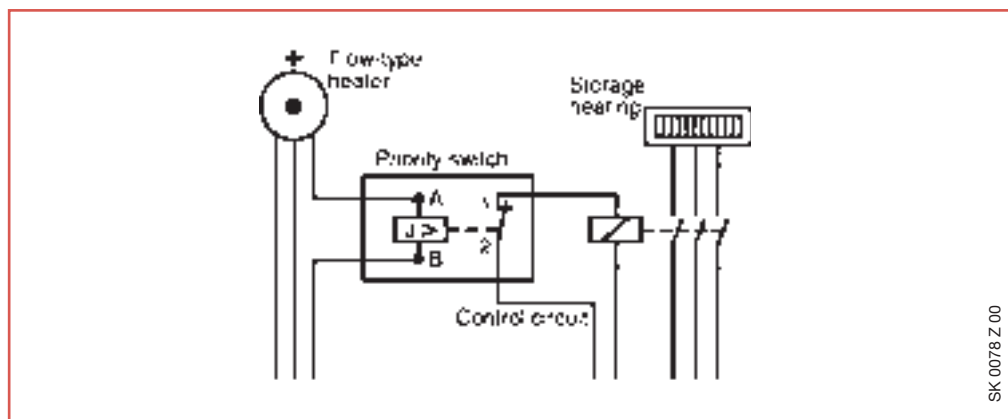

SK 0078 Z 00

Technical characteristics	E 451-5.7	E 452-5.7
Operating coil		
Range of rated current equivalent to	6.7 ... 39 A 1.5 ... 9 kW at 230 V, 4.6 ... 27 kW at 230/400 V	
Threshold current	3.1 ... 5.3 A	
OFF delay (max.)	0 main half waves	2 main half waves
Max. continuous current	43 A	
Therm. continuous capacity at 40 °C/104 °F	5 W	
Contact assembly		
Control contact	1 NC contact	
Rated contact current at 250 V	1 A	
Contact material	solid silver	
Max. switching voltage	400 V	
Max. switching capacity	230 VA	
Max. switched current	1 A	
Max. inrush current peak	5 A	
Electr. service life	> 10 ⁵ operations	
Mechanical service life	ca. 2 x 10 ⁶ operations	
Max. electrical switching rate	ca. 1800 operations/hour	
ON duration	100 %	
Ambient temperature	– 20 °C/– 4 °F to + 40 °C/104 °F	
Response time	10 ... 20 ms	
Release time	5 ... 20 ms	≥ 20 ms
Test voltage contact/coil	2.5 kV	
Clearance and creepage distance	C/250 V AC cording to IEC 669-1-23	
Degree of protection	IP 40	
Protection against electric shock	according to DIN VDE 0106 Part 100 (BGV A2)	
Terminal contact	series coil up to 16 mm ² , control contact up to 2.5 mm ²	



RAL overload relays

Installed downstream of the main circuit-breaker in a single-phase system, they constantly compare the actual power consumption to the preset threshold. An acoustic alarm alerts that some appliances must be switched off to avoid tripping the main circuit-breaker whenever the preset threshold is exceeded. The device calibration is 3 kW.

RAL built in relay output contact allows the following functions to be implemented:

- a) remote signalling (acoustic or lighting)
- b) opening a divisional circuit-breaker to disable a non essential electrical appliance.

Function b) allows one or more appliances to be automatically switched off in order to keep the power consumption within the preset limit and avoid unwanted tripping of the current-limiting device installed outside the home (e.g. in the basement). RAL must be reset manually.

Adjustable range kW	Order details Type code	Order code	Bbn 8012542 EAN	Price 1 piece	Price group	Weight 1 piece kg	Pack unit pc.
0/3	RAL 3	2CSM111200R1301	400509			0.200	1
0/6	RAL 6	2CSM121200R1301	400608			0.200	1

7

Technical characteristics		RAL3	RAL6
Rated voltage U_n	[V]		a.c. 230
Rated current I_n	[A]	18.3	27.5
Rated contact capacity I_n	[A]	12 $\cos\phi=1$; 4 $\cos\phi=0.8$	
Rated frequency	[Hz]	50	
Adjustment ranges	[A]	0 ... 18.3	0 ... 27.5
Power consumption	[W]	10	
Modules	[No.]	2	
Intervention delay		instantaneous	

Acoustic warning

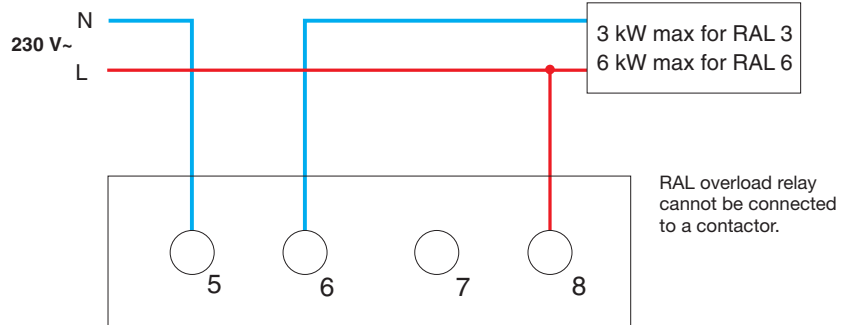

OEPM0051

Load release

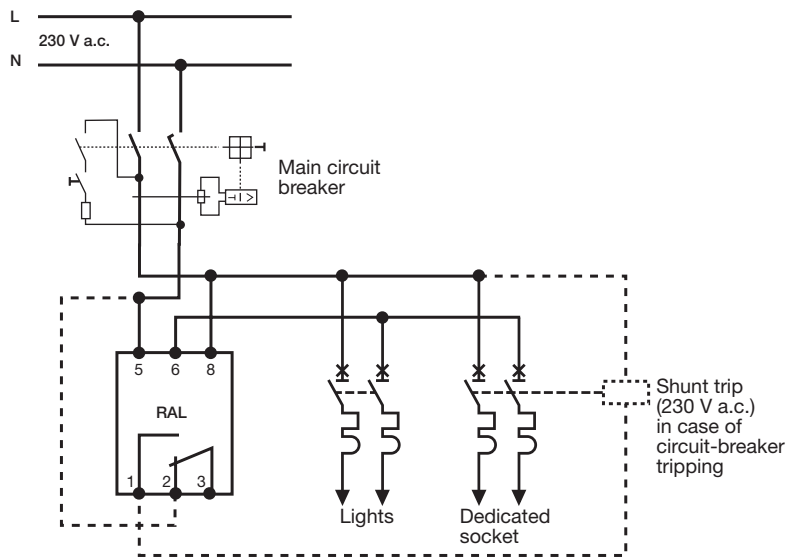

OEPM0052



LSS1/2 load shedding switch

Installed downstream of the main circuit-breaker, it compares the actual power consumption of the system to a preset maximum permitted value, and prevents tripping of the main circuit-breaker by sequentially switching off a maximum of two non-priority loads (NPL1 and NPL2) when the preset threshold is exceeded. A green LED indicates the presence of the supply voltage, and two red LEDs indicate the load OFF conditions. At preset time intervals, the device automatically attempts to reconnect the previously disabled loads. Note: In unbalanced three-phase systems same function of LSS1/2 can be implemented via DMTME multimeters. Digital outputs of the multimeter can be set to trip with an user defined delay to switch off - by means of external contactors - non priority loads of arbitrary consumption. See for details page 10/142.

Order details	Order code	Bbn 8012542	Price 1 piece	Price group	Weight 1 piece	Pack unit
Type code		EAN			kg	pc.
LSS1/2	2CSM112500R1311	274407			0.400	1

Technical characteristics

Rated voltage U_n	[V]	a.c. 230
Rated capacity I_n	[A]	90
Rated contact capacity I_n NPL1 and NPL2	[A]	16 each (terminals 12 and 14)
Rated frequency	[Hz]	50/60
Regulating thresholds	[A]	5...30 10...60 15...90
Load reinsertion delay		5-7 min. (NPL1); 4-5, 50 min. (NPL2)
Load disinsertion delay		about 2 sec.
Indicators		1 green LED = supply voltage available 2 red LEDs = loads switched off
Load OFF remote signalling	[A]	1 (terminals 11 and 13)
Terminals		Primary load 35 mm ² Non priority loads 10 mm ²
Power consumption	[W]	5
Modules	[No.]	5

- The device must be inserted into the network downstream of the main circuit breaker
- PL= Primary Load
- NPL= Non Priority Load

Single-phase wiring diagram for non-prioritary loads with 16 A or more current consumption

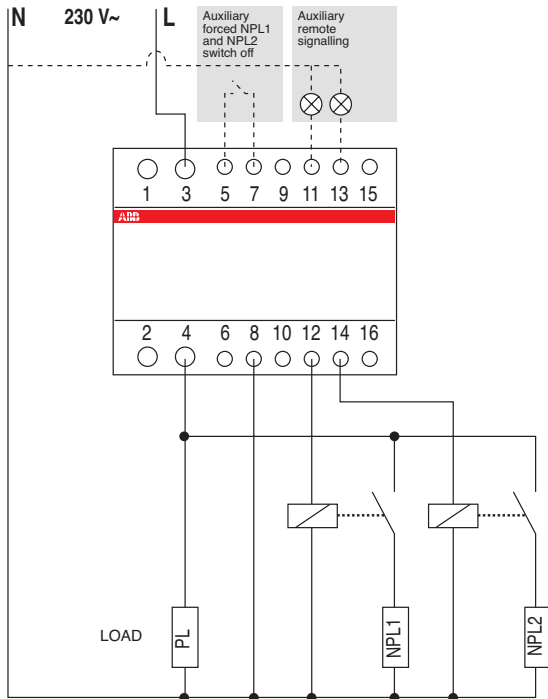

Single-phase wiring diagram

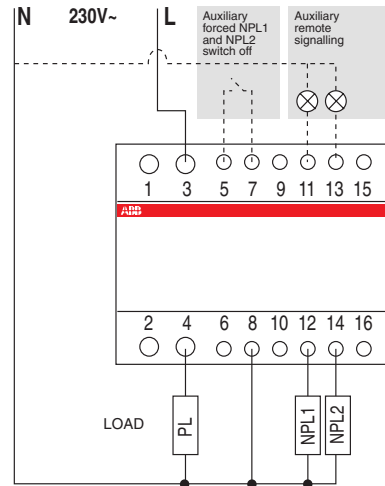

Balanced three-phase wiring diagram

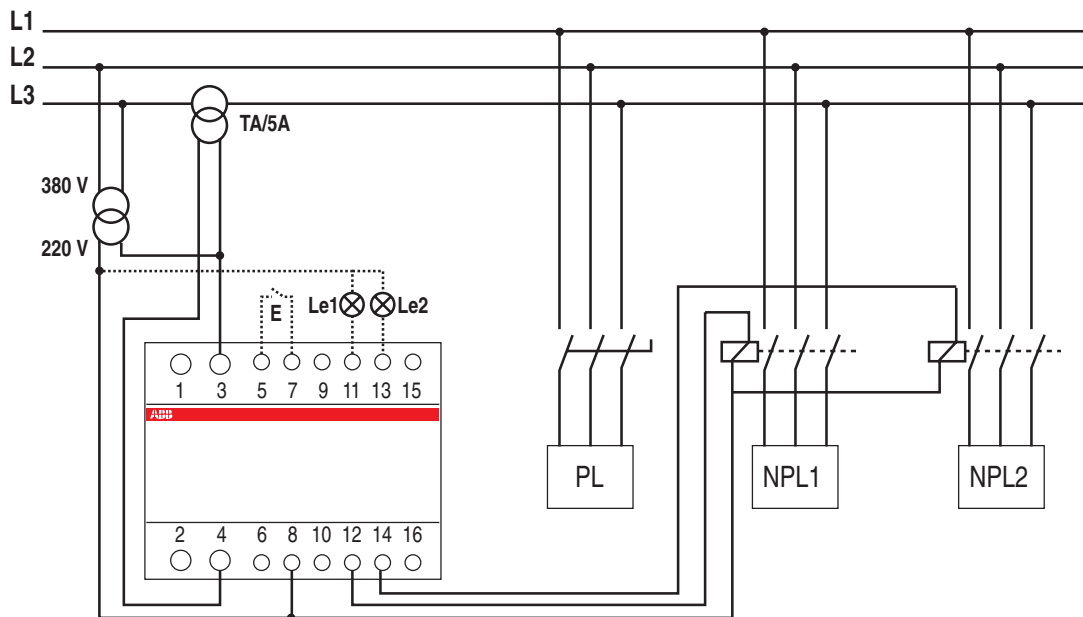

OEPM0150



E 235 mains disconnection relays - Bioswitch

Constant exposure of electrical interference fields originating from live conductors - as is the case e.g. in bedrooms - may impair the well-being of people, experts say.

With the extra base load adapter E235-GLA, the mains disconnection relays can be switched on manually.

For the permanent installation of loads that switch on independently of the supply voltage, such as fluorescent lamps, a E235-GLE PTC base load element is available.

Description	Order details		Bbn 4016779 EAN	Price 1 piece	Price group	Weight 1 piece kg	Pack unit pc.
	Type code	Order code					
mains disconnection relay	E 235-NFS	2CDE110000R1701	571821			0.065	1
base load element	E 235-GLE	2CDE100500R1711	571814			0.001	1
base load adapter	E 235-GLA	2CDE100510R1711	571869			0.070	1

Wiring diagram

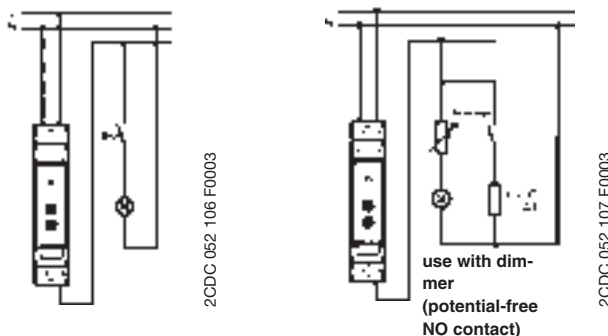

Technical features

Short circuit rupturing capacity	16 A/230 V a.c.
Rated frequency	50/60 Hz
Range of control voltage	0.9 to 1.1 Un
Load of filament lamps	2300 W
Fluorescent lamp load:	
twin lamp circuit	100 W
shunt compensated	56 W
electronic ballast	max. 36 W, dependent on manufacturer
Induce load	6 A cosφ = 0.6
Max. switching capacity (cosφ 0.5)	3500 VA
Intrinsic consumption ca.	1 W
Control voltage	5 V a.c.
Adjustable making capacity	2 - 15 VA
Breaking capacity	0.66 x making capacity
ON delay	50 ms
OFF delay	ca. 3 sec.
Contact assembly	1 NO contact
Service life at rated load	> 100000 switching cycles
Ambient temperature	- 10 °C/14 °F to +45 °C/113 °F
Connection capacity (clamping terminal)	max 2.5 mm ²



SQZ3 phase and sequence relay

SQZ3 relay performs the following continue monitoring functions on three-phase networks at 400 V a.c.:

- phase sequence
- phase failure
- minimum voltage (adjustable up to 70% of Vn).

If one of the three failures is detected, the output relay (safety switching contact) intervenes with a delay adjustable from 2 to 20 seconds for minimum voltage only and controls the following:

- acoustic alarms
- motor controlling contactors
- circuit-breakers with coils.

Order details	Order code	Bbn	Price	Price group	Weight	Pack unit
Type code		8012542	1 piece		1 piece	
		EAN			kg	pc.
SQZ3	2CSM111310R1331	372004			0.300	1

Wiring diagram

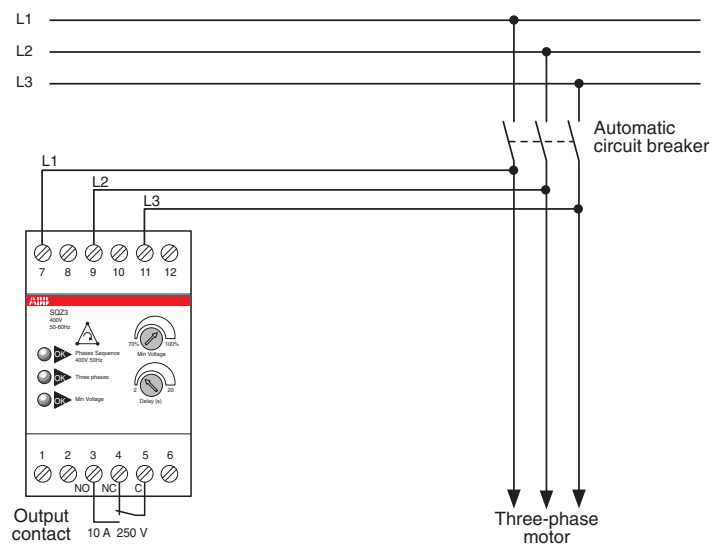

Technical features

Supply voltage	[Vn]	400 V a.c.
Frequency	[Hz]	50/60
Contact type	[A]	1 CO, 250 V, 10 A (cosφ=1) safety switching
Minimum voltage adjustment trimmer	[%]	100 to 70% of Vn
Intervention delay adjustment trimmer	[s]	2 to 20 (only for min. voltage)
Protection degree	[IP]	20
Operating temperature	[°C]	-10...+55
Power consumption	[W]	1.5
Modules	[No.]	3



Maximum and minimum current/voltage relays

These relays are used for monitoring current and voltage on single-phase electrical networks, to ensure perfect protection of the devices installed on the system.

The range includes:

- **maximum current (RHI)** and **maximum voltage (RHV)** relays. The control relay remains on as long as the measured quantity stays below the preset threshold value.
- **minimum current (RLI)** and **minimum voltage (RLV)** relays. The control relay remains on as long as the measured quantity stays above a preset threshold value.

Both types of relays have trimmers for adjusting the switch-off delay and the hysteresis (from 1 to 45%).

The 100 V and 5 A relay inputs allow indirect connection of external CTs and VTs for monitoring voltage and current values exceeding the maximum device scale

Type	Order details		Bbn 8012542	Price 1 piece	Price group	Weight 1 piece	Pack unit
	Type code	Order code	EAN			kg	pc.
maximum current relay	RHI	2CSM121310R1321	334309			0.300	1
maximum voltage relay	RHV	2CSM111310R1321	334101			0.300	1
minimum current relay	RLI	2CSM122310R1321	334200			0.300	1
minimum voltage relay	RLV	2CSM112310R1321	334002			0.300	1

Technical characteristics

Rated voltage U_n	[V]	a.c. 230
Contact type		1 CO, 250 V, 16 A
Rated frequency	[Hz]	50/60
Current relay alarm thresholds	[A]	2, 5, 10
Voltage relay alarm thresholds	[V]	100, 300, 500
Adj. calibration of I_n and $V_n\%$	[%]	30...100
Adjustable hysteresis value	[%]	1...45
Time delay	[s]	1...30
Power consumption	[W]	2
Modules	[No.]	3
Control relay alarm indication		red LED on = alarm
Power supply lighting indication		green LED on = ON
Alarm indication		blinking green LED = alarm

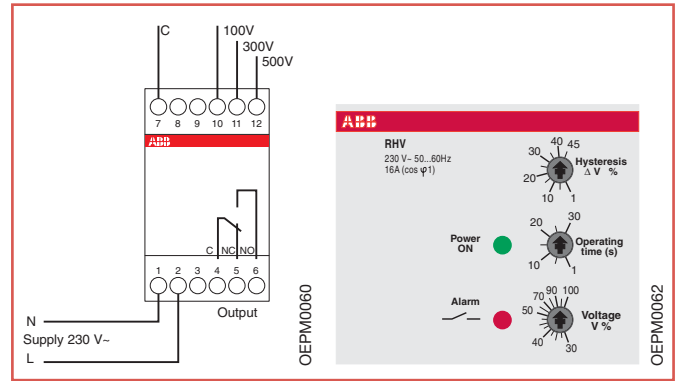
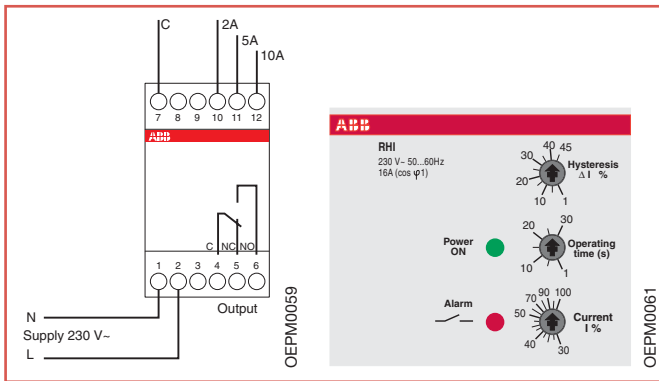

Maximum voltage relay (RHV) application example

Monitoring a load with the following ratings:

- $I_n = 5 \text{ A}$ (standard rated operating current)
- $V_n = 230 \text{ V a.c.}$ (standard rated operating voltage)
- $V_{max} = 250 \text{ V a.c.}$ (RHV relay intervention voltage)

1. Connect as in the diagram (since $V_{max} = 250 \text{ V}$).

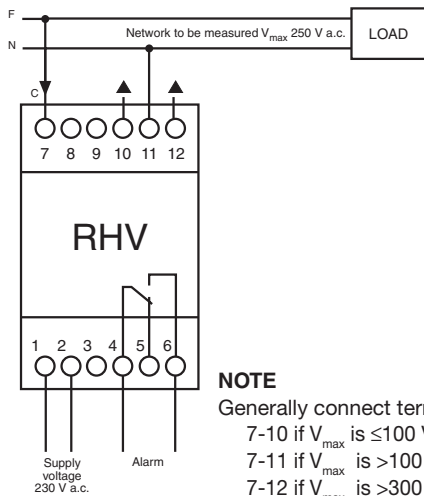

NOTE
Generally connect terminals:
7-10 if V_{max} is $\leq 100 \text{ V}$
7-11 if V_{max} is $> 100 \text{ V}$ and $\leq 300 \text{ V}$
7-12 if V_{max} is $> 300 \text{ V}$ and $\leq 500 \text{ V}$

2. Set the "Voltage%" trimmer to 83.33%, since:
$$V\% = \frac{250 (V_{max})}{300 (V_{set})} \times 100 = 83.33\%$$
being terminal 7-11 wired.
3. Set the "hysteresis %" trimmer; choosing 5% gives a intervention range from 237.5 to 250 V ($250 - 5\% = 237.5 \text{ V}$). The relay will switch at 250 V and return to its normal state at 237.5 V
4. Adjust the "delay" trimmer to select the desired relay intervention delay (1...30 sec). During this delay the "Power ON" LED blinks; at the end of the delay the "Alarm" LED becomes steadily lit and the relay intervenes.

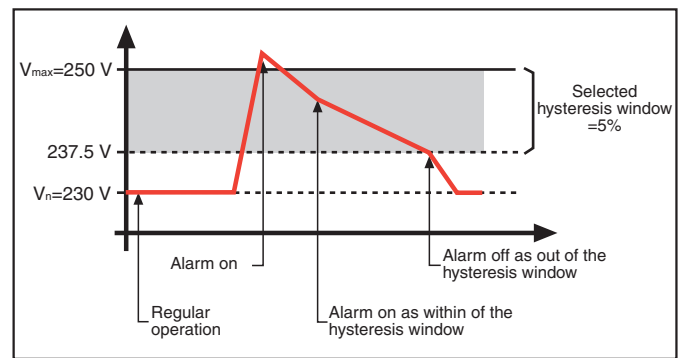



E 236 undervoltage monitoring relays

Function

The green LED is lit when the supply voltage is applied. If each phase voltage exceeds 195 V (US1) or exceeds the preset threshold value (US2) with respect to the neutral including the hysteresis when switching the device on, the relay switches immediately into the working position. The yellow LED is lit. If at least one phase voltage falls below the threshold value, the relay goes back into its normal position and the yellow LED goes out.

If also phase 2 fails, the green LED goes out, too.

It is indispensable to connect the neutral conductor!

Application - devices with 2CO contacts

For the control of three-phase undervoltage (each phase to neutral) of switchgear, also for installations according to DIN VDE 0100-718 (power installations in hospitals and rooms used for medical purposes outside of hospitals) and DIN VDE 0108-100 (power installations and safety supply in buildings where many people gather).

US 1: 3 phases to neutral with fixed threshold at 195 V; hysteresis fixed 5 %

US 2: 3 phases to neutral with fixed threshold at 160 – 240 V; hysteresis fixed 5 %

Contact	Order details	Bbn	Price	Price	Weight	Pack
	Type code	4016779	1 piece	group	1 piece	unit
		EAN			kg	pc.
2CO	E 236-US 1	2CDE165000R2001	511087		0.095	5
2CO	E 236-US 2	2CDE165010R2001	511094		0.095	5

7

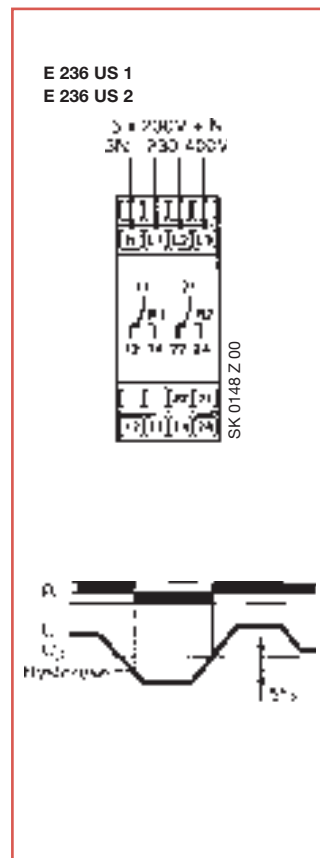

Technical features

	US 1	US 2
Rated voltage	250 V a.c.	
Frequency	48-63 Hz	
Measuring range:	supply voltage	3N 400/230 V a.c. (terminals N-L1-L2-L3)
	overload capacity	3N 459/265 V a.c.
Switching capacity	device in series (distance < 5 mm): 750 VA (3 A/250 V a.c.); device not in series (distance > 5 mm): 1250 VA (5 A/250 V a.c.)	
Rated insulation voltage	250 V a.c. (corresponds with IEC 664-1)	
Rated surge voltage	4 kV	
Tripping delay	ca. 100 ms	
Creepage and creepage distance	> 6 mm (between contact and electronics)	
Mechanical service life	20 x 10 ⁶ operations	
Electrical service life at 10000 VA	2 x 10 ⁵ operations	
Max. switching rate	max. 6/min (1000 VA Ohmic load); max. 60/min (100 VA Ohmic load)	
Ambient temperature	-25 °C/-13 °F to +55 °C/131 °F	
Overvoltage category	III	
Accuracy in non-changing environment:		
	setting tolerance (US 2)	≤ 5 %
	repeat accuracy	±1 %
	temperature effect	≤ 0.1 %/°C
Terminals	up to 4 mm ²	
Specifications	VDE 0110 and VDE 0435	
EMC tests	EM 50081-1 and EN 50082-2	
Displays	LED green= supply voltage applied; LED yellow= relay status	
Power loss	1.7 W	

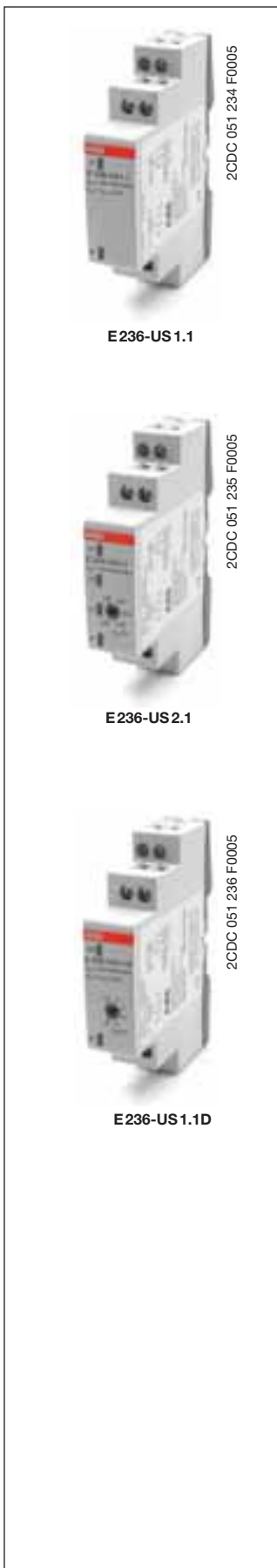

Devices for panel installation onto mounting rails (35 mm) according to DIN EN 60715
 mounting depth: 68 mm
 mounting width: 17.5 mm = 1 module
 color: gray, RAL 7035

Application - devices with 1CO contact

For three-phase undervoltage monitoring (each phase connected to a neutral conductor) of switch-gear. Devices with fixed threshold value (US 1.x and US 1.1 D) also for installations according to DIN VDE 0100-718 (for medical purposes) and DIN VDE 0108-100 (power installations and safety supply in installations for gathering of people).

US 1.1: 3 phases to neutral conductor with fixed threshold value at 195 V; hysteresis fixed at 5 %

US 2.1: 3 phases to neutral conductor with threshold value range of 160 – 240 V; hysteresis fixed at 5 %

US 1.1D: 3 phases to neutral conductor with fixed threshold value at 195 V; hysteresis fixed at 5 %, but with switch-on delay of 0.1 (6 sec.) to 10 min

Technical features	US 1.1	US 2.1	US 1.1D
Supply circuit			
Supply voltage (= measured voltage):	3N~ 400/230 V AC (terminals N-C1-C2-C3)		
Overvoltage permanent:	3N~ 459/265 V AC		
Frequency:	48 – 63 Hz (AC sinus)		
Rated surge voltage:	4 kV		
Overvoltage category:	III		
Output circuit (isolated two-way-switch)			
Rated voltage:	250 V AC		
Switching capacity:	1250 VA (5 A/250 V AC)		
Continuous current:	1250 VA (5 A/250 V AC)		
Fuse protection:	5 A flink		
Serviceable life, mechanical:	15x10 ⁸ switchover cycles		
Serviceable life, electric:	2x10 ⁵ switchover cycles at 1,000 VA resistive load		
Max. switching rate:	max. 6/min at 1,000 VA resistive load max. 60/min at 100 VA resistive load		
Trip delay:	ca. 200 ms		
Pick-up delay (US 1.1D)	0.1 – 10 min		
Accuracy under constant conditions			
– setting accuracy (US 2.1/1.1D):	≤ 5 % of full scale value		
– repeat accuracy:	≤ 2 %		
– temperature effect:	≤ 1 %		
Ambient temperature:	– 25° to + 55 °C		
Terminals:	1 x 0.5 to 2.5 mm ² with/without connector sleeve 1 x 4 mm ² without connector sleeve 2 x 0.5 to 1.5 mm ² with/without connector sleeve 2 x 2.5 mm ² without connector sleeve		
Pick-up torque:	max. 1 Nm		
Mounting position:	optional		
Vibration resistance:	10 to 55 Hz 0.35 mm (IEC 68-2-6)		
Shock resistance:	15 g 11 ms (IEC 68-2-27)		
Standards:	VDE 0110 und VDE 0435		
EMC tests:	EN 61000-6-2 and EN 61000-6-4		
Back-up fuse	≤ 16 A		
Displays:	green LED U/t ON	all 3 voltages ok	
	green LED U/t flashes	time-out indication	
	yellow LED ON/OFF	position of output relay	

All measured inputs have to be connected to one phase each. If no three-phase measurement should be carried out, measured inputs have to be connected to one phase to apply the required voltage to all measured inputs. If a load causes inverse voltage exceeding the threshold value U_s, phase failures cannot be identified.

A neutral conductor must be connected in any case!



E236-US 1.1

2CDC 051 234 F0005



E236-US 2.1

2CDC 051 235 F0005



E236-US 1.1D

2CDC 051 236 F0005

Undervoltage monitoring device with pick-up delay E236-US 1.1D

If the measurement of the voltage of all phases connected exceeds the switching threshold U_s , including the hysteresis, the time delay (t) starts to run and the (green LED U/t) flashes. Upon expiry of the time delay (t), the output relay R picks up (yellow LED on, green LED U/t flashes). If the measured voltage of one of the connected phases falls below the switching threshold U_s , the output relay de-energizes (yellow LED is off, green LED U/t is off).

Contact	Order details		Bbn	Price	Price	Weight	Pack
	Type code	Order code	4016779	1 piece	group	1 piece	unit
			EAN			kg	pc.
1 two-way switch	E 236-US 1.1	2CDE165001R2001	651776			0.05	10
1 two-way switch	E 236-US 2.1	2CDE165011R2001	651783			0.05	10
1 two-way switch	E 236-US 1.1D	2CDE165001R2011	651790			0.05	10

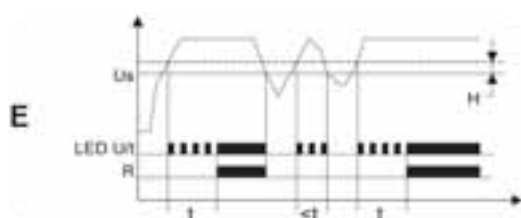

Function E236-US 1.1D

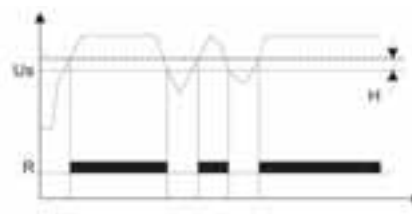

Function E236-US 1.1 and US 2.1

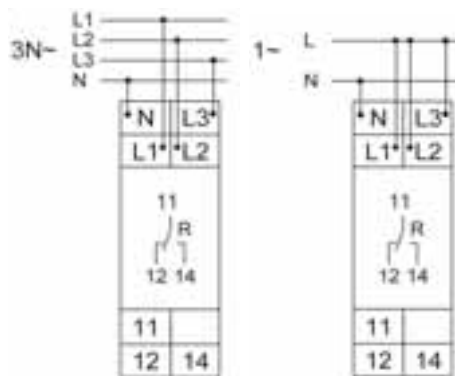

Wiring E236-US 1.1 and US 2.1

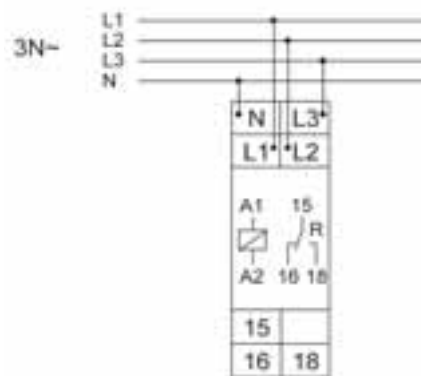

Wiring E236-US 1.1D

2CSC400120F0202

LEE 230 extractable power failure signalling lamp



LEE 230 extractable power failure signalling lamp

The LEE 230 lamp is an automatic electronic lamp that can be installed in any modular socket or wiring accessory socket conforming to the German VDE Schuko standard (e.g. ABB M1173 or M1175), to the Italian standard P11 10A, or to the 10/16 A Italian dual standard.

The device functions both as a power failure signalling lamp and as a lighting device, to be used for example during maintenance activities or when seeking faults in the panel.

Pack	Order details		Bbn	Price	Price	Weight	Pack
	Type code	Order code	8012542	1 piece	group	1 piece	unit
			EAN			kg	pc.
Blister	LEE-230	2CSM111000R1361	507406			0.100	1

Technical characteristics

2P 10 A plug		distance between pins 19 mm, pin ø 4 mm
Supply	[V]	230 a.c., 50-60 Hz
Recharge time	[h]	24
Endurance	[h]	3
Lighting level	[mcd]	3000
Operating temperature	[°C]	0...+45
Min. life cycle		5 years (battery)

Additional technical features

LEE-230 lamp automatically switches on when the voltage fails; the built-in rechargeable battery guarantees the supply.

It is particularly useful thanks to its construction and functional characteristics:

- it can be extracted from the socket and used as a torch with ON-OFF button on its frontal side
- when necessary it can work with standard sockets
- it can be moved when it is needed
- it has a long operation endurance, up to three hours
- it is ready to use, it does not require installation
- with a screw (ø 3.5 mm, L 16 mm) it is possible to fix it preventing the extraction from the M1173 ABB sockets with central hole
- the projecting part of the Schuko profile is very small (8 mm).

The two LEDs placed on the frontal side of the lamp indicate its operation condition:

- the red LED indicates the recharge activity and that, in the case of a network voltage back-out, the lamp will remain off
- the green LED indicates the recharge activity and that, in the case of a network voltage black-out, the lamp will switch on (it will automatically switch off when the voltage returns).

By pushing the frontal pushbutton it is possible to change the status; if you do not use the lamp for a prolonged time it is suggested to set the first condition in order to preserve the battery life.

ABB offers a wide range of analogue voltmeters, ammeters, frequency meters, power factor meters, available in modular or front panel version.

Voltmeters, ammeters and frequency meters are also available in a digital range (both modular and front panel version) that also includes voltmeters and ammeters equipped with output relay.

ABB multimeters allow the measurement of the main



electrical parameters in three phase networks.

The range is divided in:

- **DMTME** - modular version
- **DMTME-72** and **DMTME-96** - front panel version also available with RS485 Modbus RTU port for communicating the measured parameters over a Modbus network.

networks.

ANR is able to measure and record network parameters, information and alarms, routing data towards supervision and monitoring systems.

ABB also provides a range of electronic energy meters for single-phase (**ODINsingle** and **DELTAsingle** Meter) and three-phase systems (**ODIN Meter**, **DELTAplus** and **DELTAmax**).

like current transformers (**CT** range), voltage transformers (**TV** range) and shunts (**SNT**).



ABB offers a front panel range of network analyzers that perform true rms value of the principal electrical quantities in single and three phase

For all these measurement devices ABB provides a wide range of accessories



Index

Multimeters and network analysers

Selection tables.....	8/2
DMTME modular multimeters	8/3
DMTME-96 and DMTME-72 front panel multimeters.....	8/3
ANR network analysers	8/6
CUS serial converter	8/9

Analogue and digital instruments

Selection table for analogue and digital instruments	8/11
Modular analogue instruments.....	8/12
Interchangeable scales for analogue instruments.....	8/14
Front panel analogue instruments.....	8/15
Interchangeable scales for analogue instruments.....	8/21
Caps and terminal covers	8/25
Modular digital instruments.....	8/26
Front panel digital instruments.....	8/27
MCV-MCA voltmetric and ammetric switches	8/30
QCV-QCA front panel voltmetric and ammetric switches.....	8/31

Electronic energy meters

ODIN single phase energy meters	8/32
DELTA single phase energy meters.....	8/33
ODIN three-phase energy meters.....	8/35
DELTAplus/DELTAmax three-phase energy meters.....	8/36
Accessories for electronic energy meters	8/39

Hour counters

E233 hour counter.....	8/40
HMT hour counter	8/41

TMD temperature control units	8/42
-------------------------------------	------

Current transformer

TRFM modular current transformer.....	8/43
CTA current transformer with wound primary	8/45
Selection table CT current transformer	8/46
CT current transformer with through primary.....	8/47
CTO split core current transformer with through primary	8/50

Accessories for analogue and digital instruments

Summing current transformers.....	8/52
TV voltage transformers	8/53
Current and voltage converters.....	8/54
Transducers for angle phase meters.....	8/55
Shunts	8/56



Modular and front panel multimeters

Front panel network analysers



DMTME

DMTME-72

DMTME-96

ANR96

ANR144

Overall dimensions

6 DIN modules

72x72x90

96x96x103

96x96x130

144x144x66

Display

LED

LCD graphic backlit

Power supply

110 V a.c. 230 V a.c.

230 V a.c. 400 V a.c.

110 V a.c. 230 V a.c.

20-60 V a.c./d.c.

85-265 V a.c./d.c.

TRMS voltage

TRMS current

Frequency

Power factor

Cosφ

Active power

Reactive power

Apparent power

Active energy

Reactive energy

Apparent energy

Peak value Min/Max/Avg

Timer and count-down

Electrical parameters measurement

Power 4Q

Energy 4Q

Neutral current

Current THD

Voltage THD

Password set up

Tariff

Maximum demand

Harmonic analysis up to 31°

Wave form visualisation

Memory 1 MB

Power quality

Energy management

Outputs

Digital

Digital

Digital and analog

Inputs

Digital

Serial port

RS485

**RS485
RS232**

Protocols

Modbus RTU

**Modbus RTU
Profibus DP**

**Modbus RTU
Ethernet TCP/IP
Profibus DP**

8

DMTME multimeters

The instruments DMTME are digital multimeters that allow the measurement (in TRMS mode) of the principal electrical parameters in three-phase 230/400 Vac networks, including the max/min/average detection of the main electrical parameters and the active and reactive energy count. The different measured variables are displayed locally on four red 7-segment LED displays providing easy readability and simultaneous display of multiples measures.

The instruments DMTME combine also (in a single instrument) the functions of a voltmeter, ammeter, power factor meter, wattmeter, varmeter, frequency meter, active and reactive energy meters, allowing remarkable financial savings thanks to the reduction of space required for the panels and also of time required for cabling.

The DMTME-I-485, DMTME-I-485-96 and DMTME-I-485-72 models are additionally equipped with two relays, fully programmable as either pulse outputs for remote metering of energy consumption, or as alarm outputs.

There is also an RS485 port for communicating the measured parameters over a Modbus network.

All versions come complete with Mini CD containing the instruction manual, technical documentation, communication protocol and the DMTME-SW software.

DMTME modular multimeters

TRMS measure of VL-L, VL-N, A, W, Var, VA, kWh, kVar, PF in 230/400 V a.c. lines. Indirect connection through CT .../5 A. Auxiliary supply at 110 V a.c. and 230 V a.c.

Auxiliary supply V d.c.	RS485 Serial port	Program. digital output	Order details Type code	Order code	Bbn 8012542 EAN	Price 1 piece	Price group	Weight 1 piece kg	Pack unit pc.
110-230	-	-	DMTME	2CSM170040R1021	975700			0.450	1
110-230	■	2	DMTME-I-485	2CSM180050R1021	975809			0.450	1

DMTME-96 panel multimeters

Auxiliary supply 230 V a.c. and 110 V a.c.

RS485 Serial port	Program. digital output	Dimension	Order details Type code	Order code	Bbn 8012542 EAN	Price 1 piece	Price group	Weight 1 piece kg	Pack unit pc.
-	-	96x96	DMTME-96	2CSG133030R4022	046752			0.450	1
■	2	96x96	DMTME-I-485-96	2CSG163030R4022	046851			0.450	1

DMTME-72 panel multimeters

Auxiliary supply 230 V a.c. and 400 V a.c.

-	-	72x72	DMTME-72	2CSG132030R4022	046554			0.450	1
■	2	96x96	DMTME-I-485-72	2CSG162030R4022	046653			0.450	1



Technical characteristics

Rated voltage	[V rms]	230 +15% - 10%	DMTME, DMTME-72 and DMTME-96
	[V rms]	400 +15% - 10%	DMTME-72
	[V rms]	115 +15% - 10%	DMTME, DMTME-96
Frequency	[Hz]	45...65	
Power consumption	[VA]	<6	
Fuse protection		TO.1A	
Voltage measuring inputs			
Range	[V rms]	10...500 V (L-N)	
Max. non destructive	[V rms]	550	
Impedance (L-N)	[MΩ]	>8	
Current measuring inputs (only external CTs .../5 A)			
Range	[A rms]	0.05...5	
Overload		1.1 permanent	
Measurement accuracy			
Voltage		±0.5% F.S. ±1 digit in range	
Current		±0.5% F.S. ±1 digit in range	
Active power		±1% ±0.1% F.S. from $\cos\varphi = 0.3$ to $\cos\varphi = -0.3$	
Frequency		±0.2% ±0.1Hz from 40.0 to 99.9 Hz	
		±0.2% ±1Hz from 100 to 500 Hz	
Energy metering			
Maximum metered value for single phase		4,294.9 MWh (MVarh) with $K_A = K_V = 1$	
Maximum metered value for three phase		4,294.9 MWh (MVarh) with $K_A = K_V = 1$	
Accuracy		Class 1	
Max. power consumption	[VA]	1.4 for each input (with $I_{max} = 5A$ rms)	
Digital outputs			
Pulse duration		50 ms OFF (min)/ 50 ms ON	
Vmax on contact		48 V (d.c. or a.c. peak)	
Wmax dissipation		450 mW	
Max frequency		10 pulses/sec	
I _{max} contact		100 mA (d.c. or a.c. peak value)	
Insulation		750 V _{max}	
Programmable parameters			
kVT transformer ratio V _{prim} /V _{sec}		1...500	
kCT transformer ratio I _{prim} /I _{sec}		1...1,250	
Free hour counter	[h]	0...10,000,000, resettable	
Countdown	[h]	1...32,000	
Operating temperature	[°C]	0...+50	
Storage temperature	[°C]	-10...+60	
Relative humidity		90% max. (non condensing) at 40°C	
Overall dimensions	[mm]	105x90x58	DMTME
	[mm]	96x96x103	DMTME-96
	[mm]	72x72x90	DMTME-72

Wiring diagrams only for low voltage system

Three-phase with neutral and 3 CTs

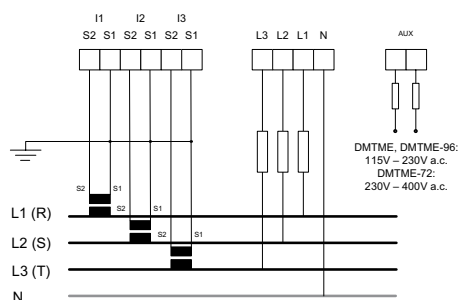

Three-phase with 3 CTs

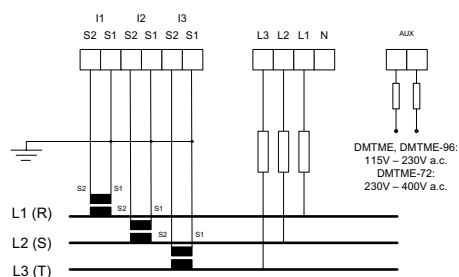

Three-phase with neutral and 3 CTs and 3 VTs
 Up to 500 V phase-neutral a direct connection is possible

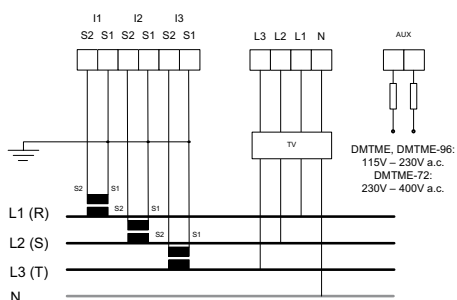

Aron type three-phase with 2 CTs and 2 VTs
 With symmetric and unbalanced network, 3 CTs and up to 800 V, beyond this value must use VT.

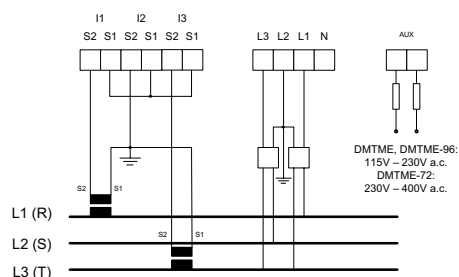

Digital output used as alarm with external relays for load command

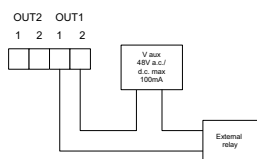

Digital output used as pulses

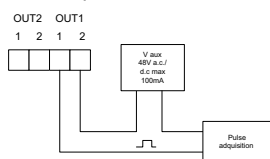

Single phase with neutral and 1 CTs

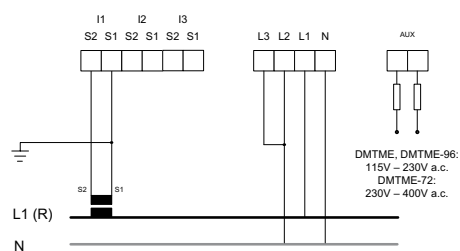

ANR Network analyser

ABB has extended its range of front panel devices with the introduction of the new ANR electrical network analysers - measuring instruments that permit advanced analysis of single and three-phase electrical distribution networks.

In particular, the ANR devices are able to measure and record network parameters, information and alarms, routing data towards supervision and monitoring systems.

Available in 96 x 96 mm or 144 x 144 mm front panel format, they are equipped with a backlit graphic LCD display.

The ANR analysers measure current and voltage in TRMS, frequency and temperature, calculate concatenate voltage and three-phase system voltage and current, power factor and cosφ, apparent, active and reactive power, THD total harmonic distortion up to the 31st harmonic, and measure active energy consumed and cogenerated, submetering the counters in total counter, programmable by the user. All codes have RS485/232 built in as a standard.

All the parameters can be stored in the 128 kbyte internal memory, expandable to up to 1 Mbyte for the ANR144 and ANR96P versions.

The devices come with a mini-CD containing:

- Instruction manual
- Technical datasheet
- SW-01 software for managing the recorded data.

All ANR versions have 2 programmable digital outputs and RS485/RS232 serial port. ANR96PRF models have Profibus DP protocol built in.



2CSC400753F0001



2CSC400754F0001

Auxiliary supply V a.c./d.c.	Program. digital input	Storage	Expandable with add-on boards	Order details Type code	Order code	Bbn 8012542 EAN	Price 1 piece	Price group	Weight 1 piece	Pack unit
20÷60	2	128 Kb		ANR96-24	2CSG113000R4051	943402			0.430	1
85÷265	2	128 Kb		ANR96-230	2CSG213000R4051	943501			0.430	1
20÷60	4	1 Mb		ANR96P-24	2CSG123000R4051	943600			0.430	1
85÷265	4	1 Mb		ANR96P-230	2CSG223000R4051	943709			0.430	1
85÷265	2	128 Kb	■	ANR144-24	2CSG114000R4051	943808			0.430	1
20÷60	2	128 Kb	■	ANR144-230	2CSG214000R4051	943907			0.430	1
20÷60	2	128 kb		ANR96PRF-24	2CSG258333R4051	583332			0.430	1
85÷265	2	128 kb		ANR96PRF-230	2CSG257153R4051	571537			0.430	1

Expandable range for versions ANR144-24 and ANR144-230

Board description	Order code	Bbn	Price	Weight	Pack
1 Mb internal memory board	ANR-1MB	2CSG000010R4051	944003	0.100	1
6 digital input board	ANR-6I	2CSG000020R4051	944102	0.100	1
4 digital output board	ANR-4O	2CSG000030R4051	944201	0.100	1
2 dig. input + 2 dig. output board	ANR-2I2O	2CSG000040R4051	944300	0.100	1
2 analogue output board	ANR-2AN	2CSG000050R4051	944409	0.100	1
4 analogue output board	ANR-4AN	2CSG000060R4051	944508	0.100	1
RS232/485 board	ANR-CM2	2CSG000070R4051	944607	0.100	1
Profibus DP board	ANR-PRF	2CSG000080R4051	944706	0.100	1
Ethernet Modbus RTU board	ANR-LAN	2CSG000090R4051	944805	0.100	1

Technical features

Dimensions			
Overall dimensions	[mm]	96 x 96 x 130 - 144 x 144 x 66	IEC 61554
Max cable section	[mm ²]	2.5	
Protection degree		IP52 on front - IP20 on terminal	EN 60529
Weight	[g]	430	
Display			
Graphic LCD		Backlit 128 x 128 pixel graphic LCD display	
Display dimensions	[mm]	ANR96: 50 x 50 - ANR144: 70 x 70	
Voltage (TRMS)			
Direct measurement	[V]	10 - 600	
Ratio transformer range kVT	[V]	0.01 - 5,000.00	
Max over voltage	[V]	750, beyond this value must use VT	
Consumption	[VA]	0.2	
Input resistor	[MΩ]	>2	
Current (TRMS). always use external CT .../5A			
3 isolated inputs	[A]	0.01 - 5	
Min current value	[mA]	10	
Consumption	[VA]	0.2	
Max over current	[A]	10 (100 A for 1 second)	
Ratio transformer range kCT		0.01 - 5,000.00	
THD			
Voltage and current		Up to 31 st harmonic	
Frequency			
Range	[Hz]	30 - 500	
Accuracy class			
Current	[%]	<0.5	EN 61036
Voltage	[%]	<0.5	
Power	[%]	<1	
Power factor	[%]	<1	
Active energy	[%]	<1	IEC 62052-11 IEC 62053-11
Reactive energy	[%]	2	IEC 62053-23
Auxiliary supply			
ANR96-230, ANR96P-230, ANR144-230	[V]	85 ±265 a.c./d.c.	
ANR96-24, ANR96P-24, ANR144-24	[V]	20 ÷ 60 a.c./d.c.	
Internal fuse		5x20 mm 315 mA 250 V Fast	
Operating environment			
Operating temperature	[°C]	-10 ÷ +50	
Storage temperature	[°C]	-15 ÷ +70	
Operating humidity	[°C]	90% without condensation	
Insulation			
Voltage insulation		3,700 V a.c. rms for 1 minute	
Serial output			
RS485			
Baud rate	[bps]	1,200 - 19,200	
Protocols		Modbus RTU, ASCII	
Internal memory			
For ANR96 and ANR144	[kbytes]	128 (usable: 80)	
For ANR96P	[Mbytes]	1	
Memory		Non-volatile data storage using internal battery	
Data retention		5 years at 25 °C	
Internal clock			
RTC clock		IEC 61038	
Class of accuracy	[ppm]	5	
Digital output			
Connection area	[mm ²]	0 ÷ 2.5	
External pulse voltage	[V]	12 ÷ 230 V a.c./d.c.	
Max current	[mA]	150	
Digital input			
Voltage	[V]	12 - 24 d.c.	

Wiring diagrams ANR96 and ANR144

2CSC400120F0202

4 wires insertion

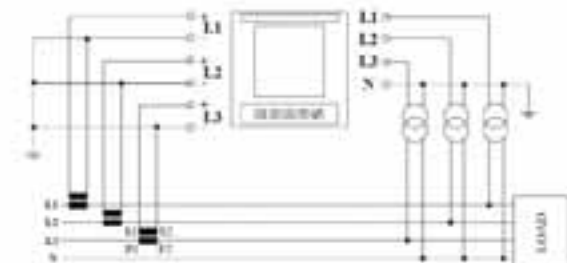

3 wires insertion

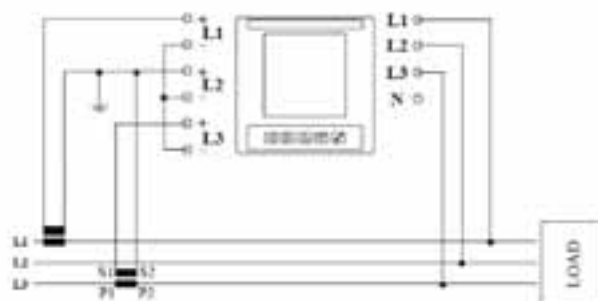

Insertion with 3 CTs and 3 VTs

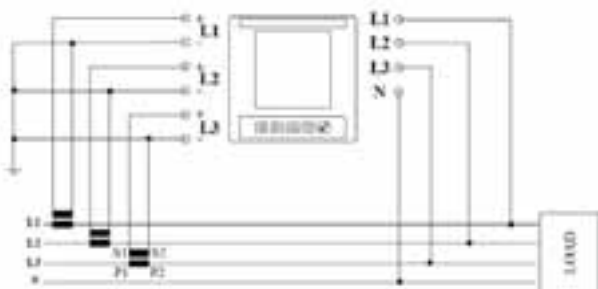

Insertion with 2 CTs

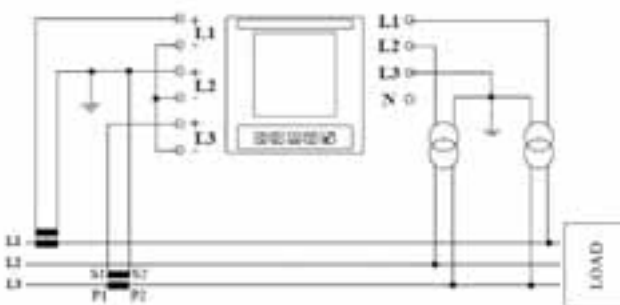

Insertion with 3 CTs

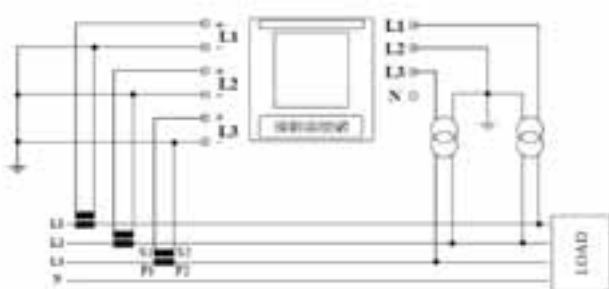

Insertion with 2 CTs and 2 VTs (Aron)

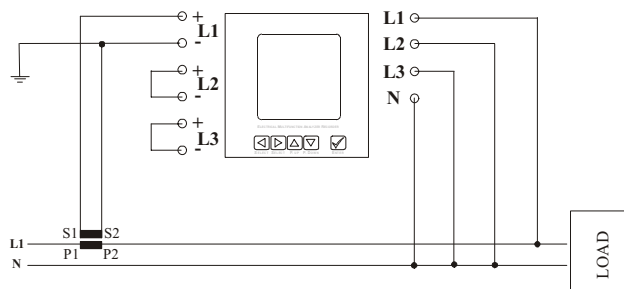

Insertion with 3 CTs and 2 VTs

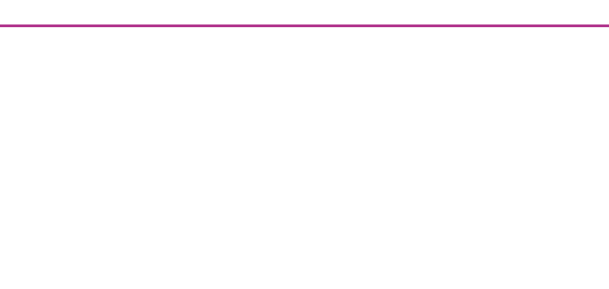

Single phase insertion with 1CT





RS485 / RS232 serial converter

The CUS multifunction serial converter has applications in all those situations which require converting or managing EIA -232 (RS-232) , EIA-485 (RS-485) or EIA-422 (RS-422) serial lines. The communication links between devices that use these types of buses (for example PLCs, measurement and control instruments, peripherals and computers running specific software applications, etc.) often call for converting between different serial interfaces, amplifying the signal on the line, isolating different parts of the communication network, etc. These diverse application requirements are readily met by the CUS converter, thanks to its configurability and operational flexibility.

The CUS assures galvanically-isolated interface conversion between the RS-232 side, the RS422-485 side and the power supply source.

Its versatility permits following operating modes:

- Full duplex conversion of RS-232 to RS-422
- Half duplex conversion of RS-232 to single-pair RS-485
- Half duplex conversion of RS-232 to two-pair RS-485
- RS-485 repeater (and monitoring function on RS-232)

The principal applications are:

- Multipoint data transmission networks
- Long distance serial links
- Galvanic separation of peripherals
- Extension of RS-485 lines

CUS serial converter/serial repeater

Version	Order details	Bbn	Price	Price	Weight	Pack
	Type code	Order code	1 piece	group	1 piece	unit
					kg	pc.
serial converter - signal repeater	CUS	2CSM200000R1031	333807		0.5	1

Technical features

Supply voltage	[V]	230 V ac ±20%
Frequency	[Hz]	50-60
Power consumption	[VA]	7 max
Power loss	[W]	3.5
Fuse		500 mA internal
Supply terminal dimensions	[mm ²]	2.5 max
RS485-422 terminal dimensions	[mm ²]	2.5 max
RS232 connection		Sub-D 9 female poles (DB9)
Max RS232 line length	[m]	15
Max RS485-422 line length	[m]	1200
Connection of multidrop units		Max 32
Operating temperature	[°C]	-20...+60
Storage temperature	[°C]	-20...+80
Modules	[No.]	6

Connection diagram

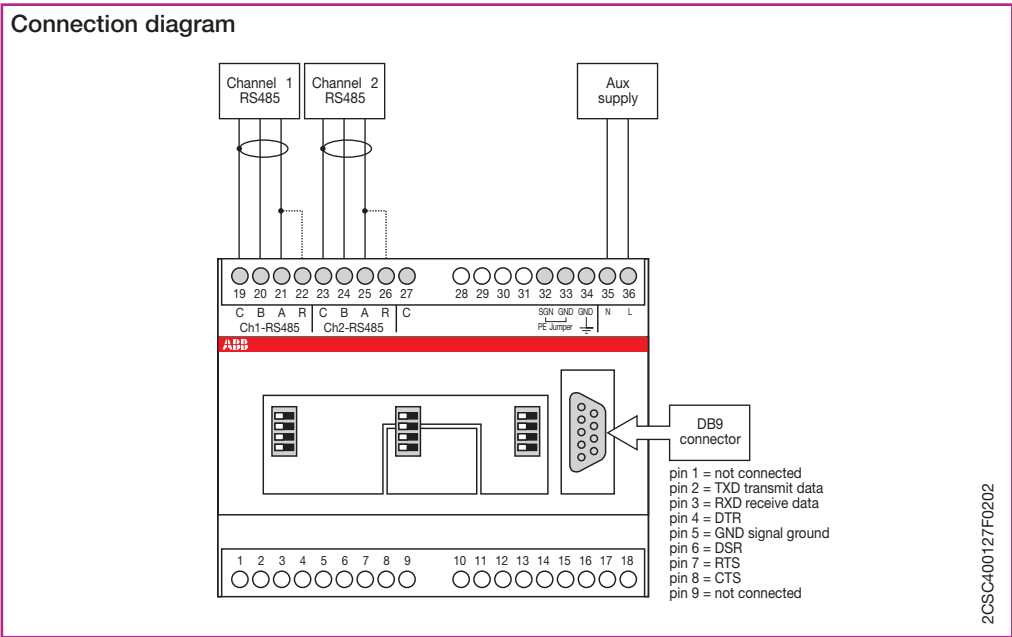



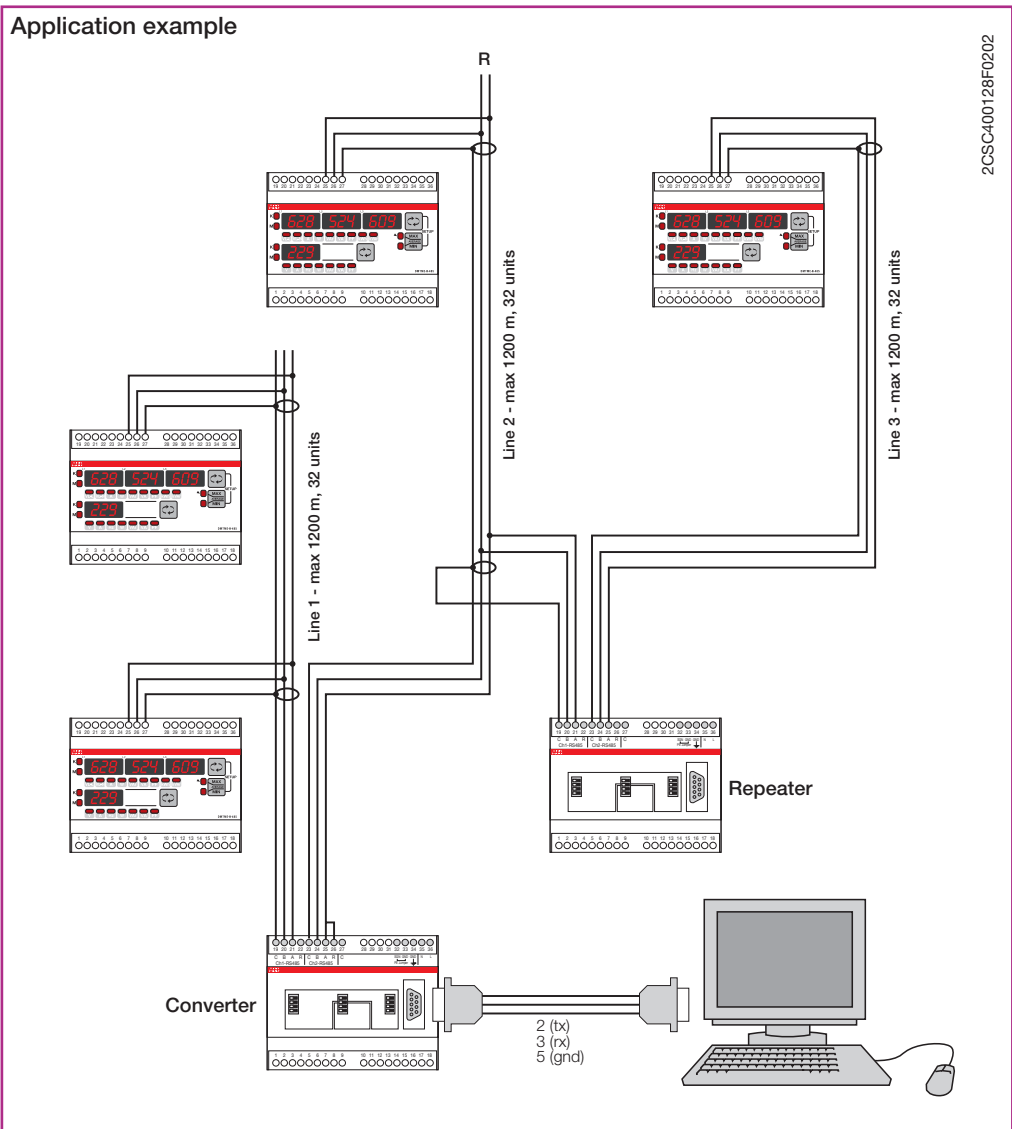











Application example



System Selection tables

pro M compact® Measurement devices

Analogue and digital instruments

Measure	Technology	Characteristics	Mounting	Insertion	Accessories	Type	
Voltage	Analog	a.c. and d.c.	3 modules	Direct	MCV voltage switches	VLM pag.8/12	
			48x48, 72x72, 96x96	Direct	MCV voltage switches	VLM-1 VLM-2 pag.8/15	
			48x48, 72x72, 96x96	Indirect	TV voltage transformers MCV voltage switches	VLM1-TV VLM2-TV pag.8/15	
	Digital	a.c. and d.c. Auxiliary supply 230 V a.c.	3 modules	Direct	MCV voltage switches	VLMD pag.8/26	
			36x72	Direct	MCV voltage switches	VLMD P pag.8/27	
	Current	Analog	a.c. and d.c.	3 modules	Direct	MCA current switches	AMT pag.8/12
Indirect					CT a.c. current transformer SNT shunt for d.c. SCL interchangeable scale MCA current switches	AMT1/A AMT2 pag.8/12	
48x48, 72x72, 96x96				Direct	MCA current switches	AMT1-A1 AMT2-A2 pag.8/17	
				Indirect	CT a.c. current transformer SNT shunt for d.c. SCL interchangeable scale MCA current switches	AMT1-A1 AMT1-A5 AMT2-A2 pag.8/17	
Digital		a.c. and d.c. Auxiliary supply 230 V a.c.	3 modules	Indirect	CT a.c. current transformer SNT shunt for d.c. MCA current switches	AMTD pag.8/26	
			36x72	Indirect	CT a.c. current transformer SNT shunt for d.c. MCA current switches	AMTD P pag.8/27	
Frequency	Analog	a.c.	3 modules	Direct		FRZ1 pag.8/12	
			48x48, 72x72, 96x96	Direct		FRZ pag.8/19	
	Digital	Auxiliary supply 230 V a.c.	3 modules	Direct		FRZ-DIG pag.8/26	
Cosφ	Analog		3 modules	Indirect	CNV-C phase meter transducer	CSF1 pag.8/12	
			48x48, 72x72, 96x96	Indirect	CNV-C phase meter transducer	COS pag.8/19	

The range provided includes analogue and digital instruments. In addition to standard measurement devices for electric quantities (voltmeters, ammeters, frequency meters, power factor meters), and a set of accessories are available, including ammetric transformers, which increase the functions of these instruments.

Analogue instruments for alternated current

Suitable for direct or indirect measurement through the appropriate accessories.



2CSC400497F0201



2CSC400517F0201

Scale	Order details		Bbn 8012542	Price 1 piece	Price group	Weight 1 piece	Pack unit
	Type code	Order code	EAN			kg	pc.

Direct voltmeters

300 V	VLM1/300	2CSM110190R1001	007906			0.200	1
500 V	VLM1/500	2CSM110220R1001	000006			0.200	1

Direct ammeters

5 A	AMT1/5	2CSM310030R1001	000709			0.200	1
10 A	AMT1/10	2CSM310040R1001	000105			0.200	1
15 A	AMT1/15	2CSM310050R1001	000204			0.200	1
20 A	AMT1/20	2CSM310060R1001	000303			0.200	1
25 A	AMT1/25	2CSM310070R1001	000402			0.200	1
30 A	AMT1/30	2CSM310080R1001	000501			0.200	1

Ammeters without scale for C.T. (sec. 5 A)

For scale SCL1	Order details		Bbn 8012542	Price 1 piece	Price group	Weight 1 piece	Pack unit
	Type code	Order code	EAN			kg	pc.
A1	AMT1/A1	2CSM320250R1001	000600			0.200	1
A5	AMT1/A5	2CSM320260R1001	000808			0.200	1

100/280V 45-65 Hz frequency meter with scale

	Order details		Bbn 8012542	Price 1 piece	Price group	Weight 1 piece	Pack unit
	Type code	Order code	EAN			kg	pc.
	FRZ1	2CSM810310R1001	008606			0.200	1

Power factor meter with scale for transducer (1 mA input)

	CSF1	2CSM720310R1001	028000			0.300	1
--	------	-----------------	--------	--	--	-------	---

Technical features

Rated voltage Un		[V]	a.c. 300, 500; d.c. 100, 300
Rated currents in a.c.	Direct reading	[A]	full scale values 5...30
	Indirect reading		full scale values 5...2500
Rated currents in d.c.	Direct reading	[A]	full scale values 0.1...30
	Indirect reading		full scale values 5...500
Frequency		[Hz]	50/60
Overload capacity		[%]	20 compared to the voltage or to the rated current
Accuracy class		[%]	1.5 (0.5 for frequency meters)
Ammeters power consumption		[VA]	5 A: 0.3 VA; 10 A: 0.6 VA; 25 A: 1 VA; 30 A: 1.2 VA
Voltmeters power consumption		[VA]	300 V: 1.5 VA; 500 V: 4 VA
Frequency meters power consumption		[VA]	<1.5 VA
Modules		[No.]	3
Protection degree			IP20
Standards			EN 60051

Analogue instruments for direct current

Scale	Order details Type code	Order code	Bbn 8012542 EAN	Price 1 piece	Price group	Weight 1 piece kg	Pack unit pc.
-------	----------------------------	------------	-----------------------	------------------	----------------	-------------------------	---------------------

Direct voltmeters

100 V	VLM2/100	2CSM210130R1001	008002			0.200	1
300 V	VLM2/300	2CSM210190R1001	008101			0.200	1

Direct ammeters

10 mA	AMT2/0.01	2CSM410330R1001	028307			0.200	1
100 mA	AMT2/0.1	2CSM410340R1001	028406			0.200	1
1000 mA	AMT2/1	2CSM410020R1001	028505			0.200	1
5 A	AMT2/5	2CSM410030R1001	028604			0.200	1
10 A	AMT2/10	2CSM410040R1001	028703			0.200	1
15 A	AMT2/15	2CSM410050R1001	028802			0.200	1
20 A	AMT2/20	2CSM410060R1001	028901			0.200	1
25 A	AMT2/25	2CSM410070R1001	029007			0.200	1
30 A	AMT2/30	2CSM410080R1001	029106			0.200	1

Ammeters without scale for shunt.../60 mV

For scale SCL2	Order details Type code	Order code	Bbn 8012542 EAN	Price 1 piece	Price group	Weight 1 piece kg	Pack unit pc.
	AMT2	2CSM420270R1001	029205			0.200	1

OEPM0065

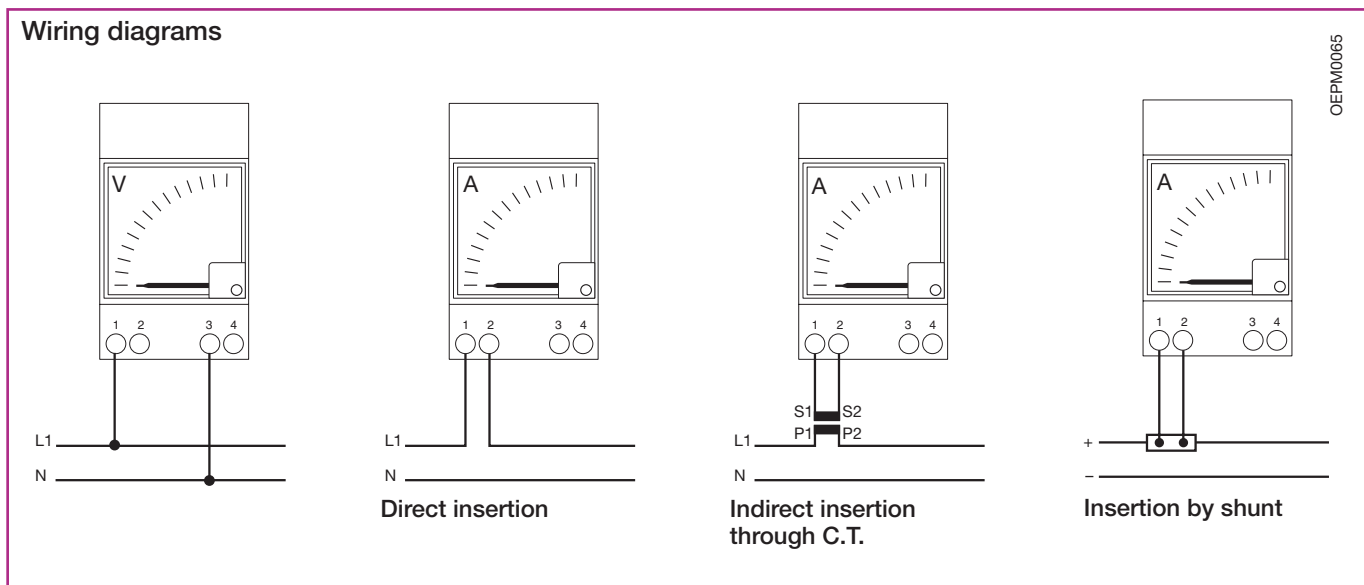

Interchangeable scales for analogue instruments

Scale	Order details	Bbn	Price	Price	Weight	Pack
	Type code	Order code	1 piece	group	1 piece	unit
		EAN			kg	pc.

Scales SCL 1 for analogue ammeters in a.c. AMT1

A1-5A	SCL 1/5	2CSM110021R1041	001201		0.010	10
A1-10A	SCL 1/10	2CSM110032R1041	001300		0.010	10
A1-20A	SCL 1/20	2CSM110075R1041	001409		0.010	10
A1-25A	SCL 1/25	2CSM110096R1041	030706		0.010	10
A1-30A	SCL 1/30	2CSM110107R1041	001508		0.010	10
A1-40A	SCL 1/40	2CSM110128R1041	030805		0.010	10
A1-50A	SCL 1/50	2CSM110149R1041	001607		0.010	10
A1-60A	SCL 1/60	2CSM110159R1041	030904		0.010	10
A1-75A	SCL 1/75	2CSM110169R1041	031000		0.010	10
A1-80A	SCL 1/80	2CSM110179R1041	001706		0.010	10
A1-100A	SCL 1/100	2CSM110189R1041	001805		0.010	10
A1-150A	SCL 1/150	2CSM110209R1041	001904		0.010	10
A1-200A	SCL 1/200	2CSM110229R1041	002000		0.010	10
A1-250A	SCL 1/250	2CSM110249R1041	031109		0.010	10
A1-300A	SCL 1/300	2CSM110259R1041	002109		0.010	10
A1-400A	SCL 1/400	2CSM110279R1041	002208		0.010	10
A1-500A	SCL 1/500	2CSM110299R1041	002307		0.010	10
A1-600A	SCL 1/600	2CSM110309R1041	031208		0.010	10
A1-800A	SCL 1/800	2CSM110329R1041	002406		0.010	10
A1-1000A	SCL 1/1000	2CSM110339R1041	002505		0.010	10
A1-1500A	SCL 1/1500	2CSM110359R1041	274704		0.010	10
A1-2000A	SCL 1/2000	2CSM110379R1041	274803		0.010	10
A1-2500A	SCL 1/2500	2CSM110389R1041	274902		0.010	10

Scale SCL 1/A5 for analogue ammeters in a.c. AMT1

A5-5A	SCL 1/A5/5	2CSM120021R1041	031307		0.010	10
A5-10A	SCL 1/A5/10	2CSM120032R1041	031406		0.010	10
A5-20A	SCL 1/A5/20	2CSM120075R1041	031505		0.010	10
A5-30A	SCL 1/A5/30	2CSM120107R1041	031604		0.010	10
A5-50A	SCL 1/A5/50	2CSM120149R1041	031703		0.010	10
A5-80A	SCL 1/A5/80	2CSM120179R1041	031802		0.010	10
A5-100A	SCL 1/A5/100	2CSM120189R1041	031901		0.010	10
A5-150A	SCL 1/A5/150	2CSM120209R1041	032007		0.010	10

Scales SCL 2 for analogue ammeters in d.c. AMT2

A1-5A	SCL 2/5	2CSM230025R1041	032106		0.010	10
A1-6A	SCL 2/6	2CSM230345R1041	032205		0.010	10
A1-10A	SCL 2/10	2CSM230035R1041	032304		0.010	10
A1-20A	SCL 2/20	2CSM230075R1041	032403		0.010	10
A1-30A	SCL 2/30	2CSM230105R1041	032502		0.010	10
A1-50A	SCL 2/50	2CSM230145R1041	032601		0.010	10
A1-80A	SCL 2/80	2CSM230179R1041	032700		0.010	10
A1-100A	SCL 2/100	2CSM230189R1041	032809		0.010	10
A1-150A	SCL 2/150	2CSM230209R1041	032908		0.010	10
A1-200A	SCL 2/200	2CSM230229R1041	033004		0.010	10
A1-250A	SCL 2/250	2CSM230249R1041	033103		0.010	10
A1-300A	SCL 2/300	2CSM230259R1041	033202		0.010	10
A1-400A	SCL 2/400	2CSM230279R1041	033301		0.010	10
A1-500A	SCL 2/500	2CSM230299R1041	033400		0.010	10



2CSC400521 F0201

SCL1/A1/100
Full scale at 90°

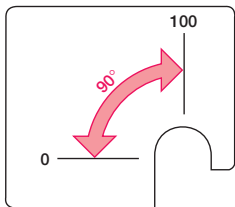

OEP10068

SCL1/A5/100
Full scale at 78°
(with extra scale)

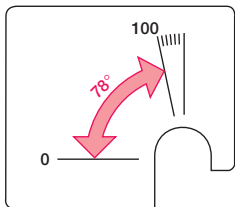



2CSC445066F0001



2CSC445080F0001

Available in both alternating current and direct current versions, they come in three standard sizes, 48 mm x 48 mm, 72 mm x 72 mm and 96 mm x 96 mm (special versions available on request). Ammeters without scale for indirect connection must be completed with the interchangeable scale according to the full scale.

Analogue voltmeters for alternating current

Size mm	Insertion	Scale	VT type	Order details Type code	Order code	Bbn 8012542 EAN	Price 1 piece	Price group	Weight 1 piece kg	Pack unit pc.
48	D	50		VLM-1-50/48	2CSG111100R4001	541707				1
48	D	60		VLM-1-60/48	2CSG111110R4001	541806				1
48	D	80		VLM-1-80/48	2CSG111120R4001	541905				1
48	D	100		VLM-1-100/48	2CSG111130R4001	542001				1
48	D	150		VLM-1-150/48	2CSG111150R4001	542100				1
48	D	200		VLM-1-200/48	2CSG111160R4001	542209				1
48	D	250		VLM-1-250/48	2CSG111180R4001	542308				1
48	D	300		VLM-1-300/48	2CSG111190R4001	542407				1
48	D	400		VLM-1-400/48	2CSG111210R4001	542506				1
48	D	500		VLM-1-500/48	2CSG111220R4001	542605				1
48	D	600		VLM-1-600/48	2CSG111230R4001	542704				1
48	I	200	110/100	VLM1-TV-110-100/200/48	2CSG121140R4001	743705				1
48	I	300	230/100	VLM1-TV-230-100/300/48	2CSG121170R4001	542803				1
48	I	500	380/100	VLM1-TV-380-100/500/48	2CSG121200R4001	542902				1
48	I	500	400/100	VLM1-TV-400-100/500/48	2CSG121210R4001	743804				1
48	I	600	500/100	VLM1-TV-500-100/600/48	2CSG121220R4001	543008				1
48	I	800	600/100	VLM1-TV-600-100/800/48	2CSG121230R4001	743903				1
48	I	1100	1000/100	VLM1-TV-1000-100/1100/48	2CSG121240R4001	744009				1
72	D	50		VLM-1-50/72	2CSG112100R4001	544104				1
72	D	60		VLM-1-60/72	2CSG112110R4001	544203				1
72	D	80		VLM-1-80/72	2CSG112120R4001	544302				1
72	D	100		VLM-1-100/72	2CSG112130R4001	544401				1
72	D	150		VLM-1-150/72	2CSG112150R4001	544500				1
72	D	200		VLM-1-200/72	2CSG112160R4001	544609				1
72	D	250		VLM-1-250/72	2CSG112180R4001	544708				1
72	D	300		VLM-1-300/72	2CSG112190R4001	544807				1
72	D	400		VLM-1-400/72	2CSG112210R4001	544906				1
72	D	500		VLM-1-500/72	2CSG112220R4001	545002				1
72	D	600		VLM-1-600/72	2CSG112230R4001	545101				1
72	I	200	110/100	VLM1-TV-110-100/200/72	2CSG122140R4001	744108				1
72	I	300	230/100	VLM1-TV-230-100/300/72	2CSG122170R4001	545200				1
72	I	500	380/100	VLM1-TV-380-100/500/72	2CSG122200R4001	545309				1
72	I	500	400/100	VLM1-TV-400-100/500/72	2CSG122210R4001	744207				1
72	I	600	500/100	VLM1-TV-500-100/600/72	2CSG122220R4001	545408				1
72	I	800	600/100	VLM1-TV-600-100/800/72	2CSG122230R4001	744306				1
72	I	1100	1000/100	VLM1-TV-1000-100/1100/72	2CSG122240R4001	744405				1

D: direct connection
I: indirect connection with VT, CT and shunt, according to the type

Size	Insertion	Scale	VT type	Order details	Bbn 8012542	Price 1 piece	Price group	Weight 1 piece	Pack unit
mm	V a.c.			Type code	Order code	EAN		kg	pc.
96 D	50			VLM-1-50/96	2CSG113100R4001	546702			1
96 D	60			VLM-1-60/96	2CSG113110R4001	546801			1
96 D	80			VLM-1-80/96	2CSG113120R4001	546900			1
96 D	100			VLM-1-100/96	2CSG113130R4001	547006			1
96 D	150			VLM-1-150/96	2CSG113150R4001	547105			1
96 D	200			VLM-1-200/96	2CSG113160R4001	547204			1
96 D	250			VLM-1-250/96	2CSG113180R4001	547303			1
96 D	300			VLM-1-300/96	2CSG113190R4001	547402			1
96 D	400			VLM-1-400/96	2CSG113210R4001	547501			1
96 D	500			VLM-1-500/96	2CSG113220R4001	547600			1
96 D	600			VLM-1-600/96	2CSG113230R4001	547709			1
96 I	200	110/100		VLM1-TV-110-100/200/96	2CSG123140R4001	744504			1
96 I	300	230/100		VLM1-TV-230-100/300/96	2CSG123170R4001	547808			1
96 I	500	380/100		VLM1-TV-380-100/500/96	2CSG123200R4001	547907			1
96 I	500	400/100		VLM1-TV-400-100/500/96	2CSG123210R4001	744603			1
96 I	600	500/100		VLM1-TV-500-100/600/96	2CSG123220R4001	548003			1
96 I	800	600/100		VLM1-TV-600-100/800/96	2CSG123230R4001	744702			1
96 I	1100	1000/100		VLM1-TV-1000-100/1100/96	2CSG123240R4001	744801			1

Analogue voltmeters for direct current

Size	Insertion	Scale	Order details	Bbn 8012542	Price 1 piece	Price group	Weight 1 piece	Pack unit
mm	V d.c.		Type code	Order code	EAN		kg	pc.
48 D	10		VLM-2-10/48	2CSG211040R4001	549307			1
48 D	15		VLM-2-15/48	2CSG211050R4001	549406			1
48 D	25		VLM-2-25/48	2CSG211070R4001	549505			1
48 D	40		VLM-2-40/48	2CSG211090R4001	549604			1
48 D	60		VLM-2-60/48	2CSG211110R4001	549703			1
48 D	80		VLM-2-80/48	2CSG211120R4001	549802			1
48 D	100		VLM-2-100/48	2CSG211130R4001	549901			1
48 D	150		VLM-2-150/48	2CSG211150R4001	550006			1
48 D	200		VLM-2-200/48	2CSG211160R4001	550105			1
48 D	250		VLM-2-250/48	2CSG211180R4001	550204			1
48 D	400		VLM-2-400/48	2CSG211210R4001	550303			1
48 D	600		VLM-2-600/48	2CSG211230R4001	550402			1
72 D	10		VLM-2-10/72	2CSG212040R4001	551003			1
72 D	15		VLM-2-15/72	2CSG212050R4001	551102			1
72 D	25		VLM-2-25/72	2CSG212070R4001	551201			1
72 D	40		VLM-2-40/72	2CSG212090R4001	551300			1
72 D	60		VLM-2-60/72	2CSG212110R4001	551409			1
72 D	80		VLM-2-80/72	2CSG212120R4001	551508			1
72 D	100		VLM-2-100/72	2CSG212130R4001	551607			1
72 D	150		VLM-2-150/72	2CSG212150R4001	551706			1
72 D	200		VLM-2-200/72	2CSG212160R4001	551805			1
72 D	250		VLM-2-250/72	2CSG212180R4001	551904			1
72 D	400		VLM-2-400/72	2CSG212210R4001	552000			1
72 D	600		VLM-2-600/72	2CSG212230R4001	552109			1
96 D	10		VLM-2-10/96	2CSG213040R4001	552703			1
96 D	15		VLM-2-15/96	2CSG213050R4001	552802			1
96 D	25		VLM-2-25/96	2CSG213070R4001	552901			1
96 D	40		VLM-2-40/96	2CSG213090R4001	553007			1
96 D	60		VLM-2-60/96	2CSG213110R4001	553106			1
96 D	80		VLM-2-80/96	2CSG213120R4001	553205			1
96 D	100		VLM-2-100/96	2CSG213130R4001	553304			1
96 D	150		VLM-2-150/96	2CSG213150R4001	553403			1
96 D	200		VLM-2-200/96	2CSG213160R4001	553502			1
96 D	250		VLM-2-250/96	2CSG213180R4001	553601			1
96 D	400		VLM-2-400/96	2CSG213210R4001	553700			1
96 D	600		VLM-2-600/96	2CSG213230R4001	553809			1



2CSC445066F0001



2CSC445080F0001



2CSC445065F0001



2CSC445068F0001



2CSC445064F0001

Analogue ammeters for alternating current

Size	Insertion	Scale	Order details	Bbn	Price	Price	Weight	Pack
mm	A a.c.	Type code	Order code	8012542	1 piece	group	1 piece	unit
				EAN			kg	pc.
48	D	1	AMT1-A1-1/48	2CSG311020R4001	543107			1
48	D	5	AMT1-A1-5/48	2CSG311030R4001	543206			1
48	D	10	AMT1-A1-10/48	2CSG311040R4001	543305			1
48	D	15	AMT1-A1-15/48	2CSG311050R4001	543404			1
48	D	20	AMT1-A1-20/48	2CSG311060R4001	543503			1
48	D	25	AMT1-A1-25/48	2CSG311070R4001	543602			1
48	D	30	AMT1-A1-30/48	2CSG311080R4001	543701			1
48	D	40	AMT1-A1-40/48	2CSG311090R4001	543800			1
48	I	1In/5	AMT1-A1/48	2CSG321250R4001	543909			1
48	I	5In/5	AMT1-A5/48	2CSG321260R4001	544005			1
72	D	1	AMT1-A1-1/72	2CSG312020R4001	545507			1
72	D	5	AMT1-A1-5/72	2CSG312030R4001	545606			1
72	D	10	AMT1-A1-10/72	2CSG312040R4001	545705			1
72	D	15	AMT1-A1-15/72	2CSG312050R4001	545804			1
72	D	20	AMT1-A1-20/72	2CSG312060R4001	545903			1
72	D	25	AMT1-A1-25/72	2CSG312070R4001	546009			1
72	D	30	AMT1-A1-30/72	2CSG312080R4001	546108			1
72	D	40	AMT1-A1-40/72	2CSG312090R4001	546207			1
72	D	50	AMT1-A1-50/72	2CSG312100R4001	546306			1
72	D	60	AMT1-A1-60/72	2CSG312110R4001	546405			1
72	I	1In/5	AMT1-A1/72	2CSG322250R4001	546504			1
72	I	5In/5	AMT1-A5/72	2CSG322260R4001	546603			1
96	D	1	AMT1-A1-1/96	2CSG313020R4001	548102			1
96	D	5	AMT1-A1-5/96	2CSG313030R4001	548201			1
96	D	10	AMT1-A1-10/96	2CSG313040R4001	548300			1
96	D	15	AMT1-A1-15/96	2CSG313050R4001	548409			1
96	D	20	AMT1-A1-20/96	2CSG313060R4001	548508			1
96	D	25	AMT1-A1-25/96	2CSG313070R4001	548607			1
96	D	30	AMT1-A1-30/96	2CSG313080R4001	548706			1
96	D	40	AMT1-A1-40/96	2CSG313090R4001	548805			1
96	D	50	AMT1-A1-50/96	2CSG313100R4001	548904			1
96	D	60	AMT1-A1-60/96	2CSG313110R4001	549000			1
96	I	1In/5	AMT1-A1/96	2CSG323250R4001	549109			1
96	I	5In/5	AMT1-A5/96	2CSG323260R4001	549208			1

D: direct connection
I: indirect connection with VT, CT and shunt, according to the type

Analogue ammeters for direct current



Size	Insertion	Scale	Order details		Bbn	Price	Price	Weight	Pack
mm		A d.c.	Type code	Order code	8012542	1 piece	group	1 piece	unit
					EAN			kg	pc.
48	D	0,5	AMT2-A2-0,5/48	2CSG411010R4001	550501				1
48	D	1	AMT2-A2-1/48	2CSG411020R4001	550600				1
48	D	5	AMT2-A2-5/48	2CSG411030R4001	550709				1
48	D	10	AMT2-A2-10/48	2CSG411040R4001	550808				1
48	I	In/60mV	AMT2-A2/48	2CSG421270R4001	550907				1
72	D	0,5	AMT2-A2-0,5/72	2CSG412010R4001	552208				1
72	D	1	AMT2-A2-1/72	2CSG412020R4001	552307				1
72	D	5	AMT2-A2-5/72	2CSG412030R4001	552406				1
72	D	10	AMT2-A2-10/72	2CSG412040R4001	552505				1
72	I	In/60mV	AMT2-A2/72	2CSG422270R4001	552604				1
96	D	0,5	AMT2-A2-0,5/96	2CSG413010R4001	553908				1
96	D	1	AMT2-A2-1/96	2CSG413020R4001	554004				1
96	D	5	AMT2-A2-5/96	2CSG413030R4001	554103				1
96	D	10	AMT2-A2-10/96	2CSG413040R4001	554202				1
96	I	In/60mV	AMT2-A2/96	2CSG423270R4001	554301				1

D: direct connection

I: indirect connection with VT, CT and shunt, according to the type

Analogue power factor meters

Size	Insertion	Scale	Order details		Bbn 8012542	Price 1 piece	Price group	Weight 1 piece	Pack unit
mm		V a.c.	Type code	Order code	EAN			kg	pc.
48	1mA transducer	90°	COS-90/48	2CSG721310R4001	555001				1
48	1mA transducer	240°	COS-240/48	2CSG721320R4001	555100				1
72	1mA transducer	90°	COS-90/72	2CSG722310R4001	555209				1
72	1mA transducer	240°	COS-240/72	2CSG722320R4001	555308				1
96	1mA transducer	90°	COS-90/96	2CSG723310R4001	555407				1
96	1mA transducer	240°	COS-240/96	2CSG723320R4001	555506				1

Analogue frequency meters

Size	Insertion	Scale	Order details		Bbn 8012542	Price 1 piece	Price group	Weight 1 piece	Pack unit
mm		V a.c.	Type code	Order code	EAN			kg	pc.
48	D	90°	FRZ-90/48	2CSG811310R4001	555605				1
72	D	90°	FRZ-90/72	2CSG812310R4001	555704				1
72	D	240°	FRZ-240/72	2CSG812320R4001	555902				1
96	D	90°	FRZ-90/96	2CSG813310R4001	555803				1
96	D	240°	FRZ-240/96	2CSG813320R4001	556008				1

D: direct connection
I: indirect connection with VT, CT and shunt, according to the type



Technical features

Rated max. reference voltage for insulation	[V]	650
Test voltage	[V]	2000 eff. (50 Hz/1 min)
Precision class		1.5 (0.5 for frequency meters)
Overload capacity ①		
- ammetric windings		up to $I_n \times 10 / < \text{sec.}$ up to $I_n \times 2 / \text{permanent}$
- voltmetric windings		up to $U_n \times 2 / < 5 \text{ sec.}$ up to $U_n \times 1.2 / \text{permanent}$
Operating temperature	[°C]	-20...+40
Storage temperature	[°C]	-40...+70
Average and max. relative humidity ② (DIN 40040)		65% (yearly average) 85% (+35 °C/60 days a year)
Vibration resistance (IEC 50-1)	[g (9.81 m/s)]	0.08-1.8 (0.35 mm/10-55 Hz; 3 axis/6 h)
Degree of protection		IP52 indoors IP00 on the terminals (IEC 144. DIN 40050) IP40 with suitable terminal covers
Materials		
- cases and front edge		self-extinguishing thermosetting material in accordance with UL94 V-0, fungus and termite resistant
- pointers (DIN 43802) ③		molded aluminium
- terminals		brass
Assembly		vertical/horizontal with special screw-on brackets ④
Dimensions W x H x D (DIN 43700/43718)	[mm]	48 x 48 X 53 72 x 72 x 53 96 x 96 X 53
Applicable standards		IEC EN 61010-1

- ① The overload can be greater for instruments enabled by a CT because the transformer generally keeps secondary current peaks to within 10 In.
- ② Tropicalization enables the instruments to withstand up to 95% max. relative humidity (+35 °C/60 days). In accordance with DIN standard 40040, they must be protected against any penetration of humidity inside the device. Terminals, screws, washers, bolts and magnets are galvanically protected against rust, while the electrical circuits are painted with the special Multicolor PC52 varnish.
- ③ The pointer damping time is 1 second. The recorded values are cleared by pressing the control provided.
- ④ With 0.5 mm - 19 mm thick panels, the screws must be attached in the fixing position nearest to the front edge of the measuring device, whereas the 20 mm - 39 mm thick panels require the screws to be fixed in the position furthest away from the front edge.

Voltmeter for alternating current

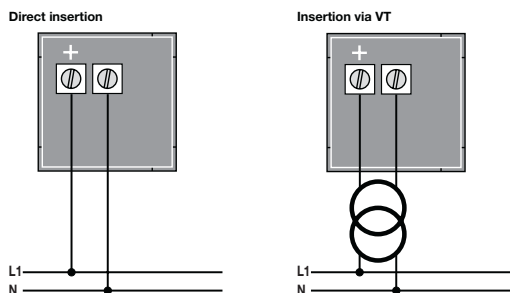

Voltmeter for direct current

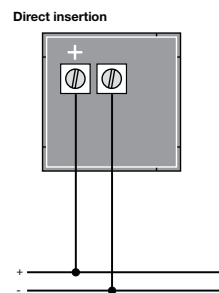

Ammeter for alternating current

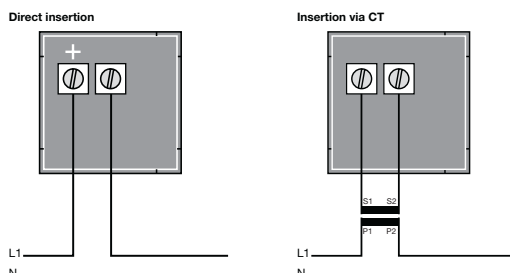

Ammeter for direct current

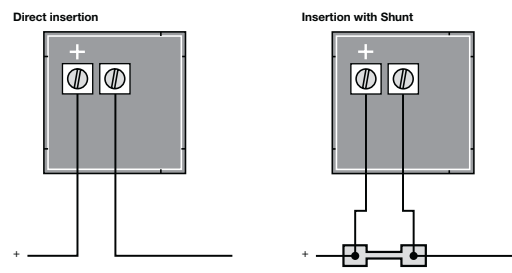

2CSC400129F0202

Interchangeable scales for front panel instrument

Interchangeable scales

Scale	Order details	Bbn	Price	Price	Weight	Pack
A a.c.	Type code	Order code	1 piece	group	1 piece	unit
					kg	pc.

Scales 48 x 48 mm, SCL-A1 for AMT1-A1/48 a.c. ammeters

1	SCL-A1-1/48	2CSG111010R5011	769408		0.010	10
5	SCL-A1-5/48	2CSG111021R5011	769507		0.010	10
10	SCL-A1-10/48	2CSG111032R5011	769606		0.010	10
15	SCL-A1-15/48	2CSG111054R5011	769705		0.010	10
20	SCL-A1-20/48	2CSG111075R5011	769804		0.010	10
25	SCL-A1-25/48	2CSG111096R5011	769903		0.010	10
30	SCL-A1-30/48	2CSG111107R5011	770008		0.010	10
40	SCL-A1-40/48	2CSG111128R5011	770107		0.010	10
50	SCL-A1-50/48	2CSG111149R5011	770206		0.010	10
60	SCL-A1-60/48	2CSG111159R5011	770305		0.010	10
80	SCL-A1-80/48	2CSG111179R5011	770404		0.010	10
100	SCL-A1-100/48	2CSG111189R5011	560500		0.010	10
150	SCL-A1-150/48	2CSG111209R5011	560609		0.010	10
200	SCL-A1-200/48	2CSG111229R5011	560708		0.010	10
250	SCL-A1-250/48	2CSG111249R5011	560807		0.010	10
300	SCL-A1-300/48	2CSG111259R5011	560906		0.010	10
400	SCL-A1-400/48	2CSG111279R5011	561002		0.010	10
500	SCL-A1-500/48	2CSG111299R5011	561101		0.010	10
600	SCL-A1-600/48	2CSG111309R5011	561200		0.010	10
800	SCL-A1-800/48	2CSG111329R5011	561309		0.010	10
1000	SCL-A1-1000/48	2CSG111339R5011	561408		0.010	10
1500	SCL-A1-1500/48	2CSG111359R5011	561507		0.010	10
2000	SCL-A1-2000/48	2CSG111379R5011	561606		0.010	10
2500	SCL-A1-2500/48	2CSG111389R5011	561705		0.010	10
3000	SCL-A1-3000/48	2CSG111399R5011	561804		0.010	10
4000	SCL-A1-4000/48	2CSG111409R5011	561903		0.010	10
5000	SCL-A1-5000/48	2CSG111419R5011	562009		0.010	10
6000	SCL-A1-6000/48	2CSG111429R5011	562108		0.010	10
8000	SCL-A1-8000/48	2CSG111439R5011	562207		0.010	10
10000	SCL-A1-10000/48	2CSG111449R5011	562306		0.010	10

Scales 48 x 48 mm, SCL-A5 for AMT1-A5/48 a.c. ammeters

1	SCL-A5-1/48	2CSG121010R5011	770503		0.010	10
5	SCL-A5-5/48	2CSG121021R5011	770602		0.010	10
10	SCL-A5-10/48	2CSG121032R5011	770701		0.010	10
15	SCL-A5-15/48	2CSG121054R5011	770800		0.010	10
20	SCL-A5-20/48	2CSG121075R5011	770909		0.010	10
25	SCL-A5-25/48	2CSG121096R5011	771005		0.010	10
30	SCL-A5-30/48	2CSG121107R5011	771104		0.010	10
40	SCL-A5-40/48	2CSG121128R5011	771203		0.010	10
50	SCL-A5-50/48	2CSG121149R5011	771302		0.010	10
60	SCL-A5-60/48	2CSG121159R5011	771401		0.010	10
80	SCL-A5-80/48	2CSG121179R5011	771500		0.010	10
100	SCL-A5-100/48	2CSG121189R5011	562405		0.010	10
150	SCL-A5-150/48	2CSG121209R5011	562504		0.010	10
200	SCL-A5-200/48	2CSG121229R5011	562603		0.010	10
250	SCL-A5-250/48	2CSG121249R5011	562702		0.010	10
300	SCL-A5-300/48	2CSG121259R5011	562801		0.010	10
400	SCL-A5-400/48	2CSG121279R5011	562900		0.010	10
500	SCL-A5-500/48	2CSG121299R5011	563006		0.010	10
600	SCL-A5-600/48	2CSG121309R5011	563105		0.010	10
800	SCL-A5-800/48	2CSG121329R5011	563204		0.010	10
1000	SCL-A5-1000/48	2CSG121339R5011	563303		0.010	10
1500	SCL-A5-1500/48	2CSG121359R5011	563402		0.010	10

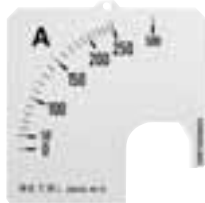

2CSC445111F0001



2CSC445111F0001

Interchangeable scales for front panel instrument

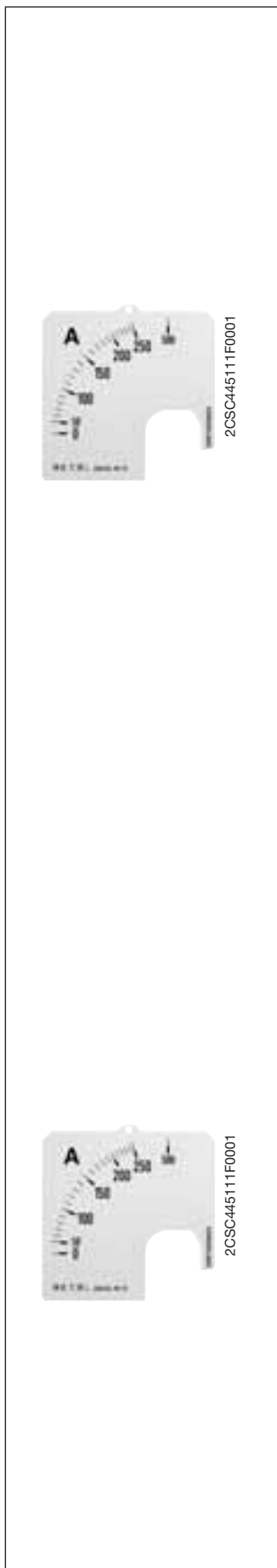

Scale	Order details	Bbn	Price	Price	Weight	Pack
A a.c.	Type code	Order code	1 piece	group	1 piece	unit
					kg	pc.
2000	SCL-A5-2000/48	2CSG121379R5011	563501		0.010	10
2500	SCL-A5-2500/48	2CSG121389R5011	563600		0.010	10
3000	SCL-A5-3000/48	2CSG121399R5011	563709		0.010	10
4000	SCL-A5-4000/48	2CSG121409R5011	563808		0.010	10
5000	SCL-A5-5000/48	2CSG121419R5011	563907		0.010	10
6000	SCL-A5-6000/48	2CSG121429R5011	564003		0.010	10
8000	SCL-A5-8000/48	2CSG121439R5011	564102		0.010	10
10000	SCL-A5-10000/48	2CSG121449R5011	564201		0.010	10

Scales 72 x 72 mm, SCL-A1 for AMT1-A1/72 a.c. ammeters

Scale	Order details	Bbn	Price	Weight	Pack
	Type code	Order code	1 piece	1 piece	unit
				kg	pc.
1	SCL-A1-1/72	2CSG112010R5011	771609	0.010	10
5	SCL-A1-5/72	2CSG112021R5011	771708	0.010	10
10	SCL-A1-10/72	2CSG112032R5011	771807	0.010	10
15	SCL-A1-15/72	2CSG112054R5011	771906	0.010	10
20	SCL-A1-20/72	2CSG112075R5011	772002	0.010	10
25	SCL-A1-25/72	2CSG112096R5011	772101	0.010	10
30	SCL-A1-30/72	2CSG112107R5011	772200	0.010	10
40	SCL-A1-40/72	2CSG112128R5011	772309	0.010	10
50	SCL-A1-50/72	2CSG112149R5011	772408	0.010	10
60	SCL-A1-60/72	2CSG112159R5011	772507	0.010	10
80	SCL-A1-80/72	2CSG112179R5011	772606	0.010	10
100	SCL-A1-100/72	2CSG112189R5011	572305	0.010	10
150	SCL-A1-150/72	2CSG112209R5011	572404	0.010	10
200	SCL-A1-200/72	2CSG112229R5011	572503	0.010	10
250	SCL-A1-250/72	2CSG112249R5011	572602	0.010	10
300	SCL-A1-300/72	2CSG112259R5011	572701	0.010	10
400	SCL-A1-400/72	2CSG112279R5011	572800	0.010	10
500	SCL-A1-500/72	2CSG112299R5011	572909	0.010	10
600	SCL-A1-600/72	2CSG112309R5011	573005	0.010	10
800	SCL-A1-800/72	2CSG112329R5011	573104	0.010	10
1000	SCL-A1-1000/72	2CSG112339R5011	573203	0.010	10
1500	SCL-A1-1500/72	2CSG112359R5011	573302	0.010	10
2000	SCL-A1-2000/72	2CSG112379R5011	573401	0.010	10
2500	SCL-A1-2500/72	2CSG112389R5011	573500	0.010	10
3000	SCL-A1-3000/72	2CSG112399R5011	573609	0.010	10
4000	SCL-A1-4000/72	2CSG112409R5011	573708	0.010	10
5000	SCL-A1-5000/72	2CSG112419R5011	573807	0.010	10
6000	SCL-A1-6000/72	2CSG112429R5011	573906	0.010	10
8000	SCL-A1-8000/72	2CSG112439R5011	574002	0.010	10
10000	SCL-A1-10000/72	2CSG112449R5011	574101	0.010	10

Scales 72 x 72 mm, SCL-A5 for AMT1-A5/72 a.c. ammeters

Scale	Order details	Bbn	Price	Weight	Pack
	Type code	Order code	1 piece	1 piece	unit
				kg	pc.
1	SCL-A5-1/72	2CSG122010R5011	772705	0.010	10
5	SCL-A5-5/72	2CSG122021R5011	772804	0.010	10
10	SCL-A5-10/72	2CSG122032R5011	772903	0.010	10
15	SCL-A5-15/72	2CSG122054R5011	773009	0.010	10
20	SCL-A5-20/72	2CSG122075R5011	773108	0.010	10
25	SCL-A5-25/72	2CSG122096R5011	773207	0.010	10
30	SCL-A5-30/72	2CSG122107R5011	773306	0.010	10
40	SCL-A5-40/72	2CSG122128R5011	773405	0.010	10
50	SCL-A5-50/72	2CSG122149R5011	773504	0.010	10
60	SCL-A5-60/72	2CSG122159R5011	773603	0.010	10
80	SCL-A5-80/72	2CSG122179R5011	773702	0.010	10
100	SCL-A5-100/72	2CSG122189R5011	574200	0.010	10
150	SCL-A5-150/72	2CSG122209R5011	574309	0.010	10
200	SCL-A5-200/72	2CSG122229R5011	574408	0.010	10
250	SCL-A5-250/72	2CSG122249R5011	574507	0.010	10
300	SCL-A5-300/72	2CSG122259R5011	574606	0.010	10
400	SCL-A5-400/72	2CSG122279R5011	574705	0.010	10

Interchangeable scales for front panel instrument



2CSC445111F0001



2CSC445111F0001

Scale	Order details	Bbn 8012542	Price 1 piece	Price group	Weight 1 piece kg	Pack unit pc.
A a.c.	Type code	Order code	EAN			
500	SCL-A5-500/72	2CSG122299R5011	574804		0.010	10
600	SCL-A5-600/72	2CSG122309R5011	574903		0.010	10
800	SCL-A5-800/72	2CSG122329R5011	575009		0.010	10
1000	SCL-A5-1000/72	2CSG122339R5011	575108		0.010	10
1500	SCL-A5-1500/72	2CSG122359R5011	575207		0.010	10
2000	SCL-A5-2000/72	2CSG122379R5011	575306		0.010	10
2500	SCL-A5-2500/72	2CSG122389R5011	575405		0.010	10
3000	SCL-A5-3000/72	2CSG122399R5011	575504		0.010	10
4000	SCL-A5-4000/72	2CSG122409R5011	575603		0.010	10
5000	SCL-A5-5000/72	2CSG122419R5011	575702		0.010	10
6000	SCL-A5-6000/72	2CSG122429R5011	575801		0.010	10
8000	SCL-A5-8000/72	2CSG122439R5011	575900		0.010	10
10000	SCL-A5-10000/72	2CSG122449R5011	576006		0.010	10

Scales 96 x 96 mm, SCL-A1 for AMT1-A1/96 a.c. ammeters

Scale	Order details	Bbn	Price 1 piece	Price group	Weight 1 piece kg	Pack unit pc.
A a.c.	Type code	Order code	EAN			
1	SCL-A1-1/96	2CSG113010R5011	773801		0.010	10
5	SCL-A1-5/96	2CSG113021R5011	773900		0.010	10
10	SCL-A1-10/96	2CSG113032R5011	774006		0.010	10
15	SCL-A1-15/96	2CSG113054R5011	774105		0.010	10
20	SCL-A1-20/96	2CSG113075R5011	774204		0.010	10
25	SCL-A1-25/96	2CSG113096R5011	774303		0.010	10
30	SCL-A1-30/96	2CSG113107R5011	774402		0.010	10
40	SCL-A1-40/96	2CSG113128R5011	774501		0.010	10
50	SCL-A1-50/96	2CSG113149R5011	774600		0.010	10
60	SCL-A1-60/96	2CSG113159R5011	774709		0.010	10
80	SCL-A1-80/96	2CSG113179R5011	774808		0.010	10
100	SCL-A1-100/96	2CSG113189R5011	584100		0.010	10
150	SCL-A1-150/96	2CSG113209R5011	584209		0.010	10
200	SCL-A1-200/96	2CSG113229R5011	584308		0.010	10
250	SCL-A1-250/96	2CSG113249R5011	584407		0.010	10
300	SCL-A1-300/96	2CSG113259R5011	584506		0.010	10
400	SCL-A1-400/96	2CSG113279R5011	584605		0.010	10
500	SCL-A1-500/96	2CSG113299R5011	584704		0.010	10
600	SCL-A1-600/96	2CSG113309R5011	584803		0.010	10
800	SCL-A1-800/96	2CSG113329R5011	584902		0.010	10
1000	SCL-A1-1000/96	2CSG113339R5011	585008		0.010	10
1500	SCL-A1-1500/96	2CSG113359R5011	585107		0.010	10
2000	SCL-A1-2000/96	2CSG113379R5011	585206		0.010	10
2500	SCL-A1-2500/96	2CSG113389R5011	585305		0.010	10
3000	SCL-A1-3000/96	2CSG113399R5011	585404		0.010	10
4000	SCL-A1-4000/96	2CSG113409R5011	585503		0.010	10
5000	SCL-A1-5000/96	2CSG113419R5011	585602		0.010	10
6000	SCL-A1-6000/96	2CSG113429R5011	585701		0.010	10
8000	SCL-A1-8000/96	2CSG113439R5011	585800		0.010	10
10000	SCL-A1-10000/96	2CSG113449R5011	585909		0.010	10

Scales 96 x 96 mm, SCL-A5 for AMT1-A5/96 a.c. ammeters

Scale	Order details	Bbn	Price 1 piece	Price group	Weight 1 piece kg	Pack unit pc.
A a.c.	Type code	Order code	EAN			
1	SCL-A5-1/96	2CSG123010R5011	774907		0.010	10
5	SCL-A5-5/96	2CSG123021R5011	775003		0.010	10
10	SCL-A5-10/96	2CSG123032R5011	775102		0.010	10
15	SCL-A5-15/96	2CSG123054R5011	775201		0.010	10
20	SCL-A5-20/96	2CSG123075R5011	775300		0.010	10
25	SCL-A5-25/96	2CSG123096R5011	775409		0.010	10
30	SCL-A5-30/96	2CSG123107R5011	775508		0.010	10
40	SCL-A5-40/96	2CSG123128R5011	775607		0.010	10
50	SCL-A5-50/96	2CSG123149R5011	775706		0.010	10
60	SCL-A5-60/96	2CSG123159R5011	775805		0.010	10
80	SCL-A5-80/96	2CSG123179R5011	775904		0.010	10
100	SCL-A5-100/96	2CSG123189R5011	586005		0.010	10

Interchangeable scales for front panel instrument



2CSC44511F0001

Scale	Order details	Bbn 8012542	Price 1 piece	Price group	Weight 1 piece kg	Pack unit pc.
A a.c.	Type code	Order code	EAN			
150	SCL-A5-150/96	2CSG123209R5011	586104		0.010	10
200	SCL-A5-200/96	2CSG123229R5011	586203		0.010	10
250	SCL-A5-250/96	2CSG123249R5011	586302		0.010	10
300	SCL-A5-300/96	2CSG123259R5011	586401		0.010	10
400	SCL-A5-400/96	2CSG123279R5011	586500		0.010	10
500	SCL-A5-500/96	2CSG123299R5011	586609		0.010	10
600	SCL-A5-600/96	2CSG123309R5011	586708		0.010	10
800	SCL-A5-800/96	2CSG123329R5011	586807		0.010	10
1000	SCL-A5-1000/96	2CSG123339R5011	586906		0.010	10
1500	SCL-A5-1500/96	2CSG123359R5011	587002		0.010	10
2000	SCL-A5-2000/96	2CSG123379R5011	587101		0.010	10
2500	SCL-A5-2500/96	2CSG123389R5011	587200		0.010	10
3000	SCL-A5-3000/96	2CSG123399R5011	587309		0.010	10
4000	SCL-A5-4000/96	2CSG123409R5011	587408		0.010	10
5000	SCL-A5-5000/96	2CSG123419R5011	587507		0.010	10
6000	SCL-A5-6000/96	2CSG123429R5011	587606		0.010	10
8000	SCL-A5-8000/96	2CSG123439R5011	587705		0.010	10
10000	SCL-A5-10000/96	2CSG123449R5011	587804		0.010	10

Scales 48 x 48 mm, SCL-A2 for AMT2-A2/48 d.c. ammeters

Scale	Order details	Bbn 8012542	Price 1 piece	Price group	Weight 1 piece kg	Pack unit pc.
A d.c.	Type code	Order code	EAN			
20	SCL-A2-20/48	2CSG231075R5011	595908		0.010	10
100	SCL-A2-100/48	2CSG231189R5011	596004		0.010	10
150	SCL-A2-150/48	2CSG231209R5011	596103		0.010	10
200	SCL-A2-200/48	2CSG231229R5011	596202		0.010	10
250	SCL-A2-250/48	2CSG231249R5011	596301		0.010	10
300	SCL-A2-300/48	2CSG231259R5011	596400		0.010	10
400	SCL-A2-400/48	2CSG231279R5011	596509		0.010	10
500	SCL-A2-500/48	2CSG231299R5011	596608		0.010	10
600	SCL-A2-600/48	2CSG231309R5011	596707		0.010	10
800	SCL-A2-800/48	2CSG231329R5011	596806		0.010	10
1000	SCL-A2-1000/48	2CSG231339R5011	596905		0.010	10

Scales 72 x 72 mm, SCL-A2 for AMT2-A2/72 d.c. ammeters

Scale	Order details	Bbn 8012542	Price 1 piece	Price group	Weight 1 piece kg	Pack unit pc.
A d.c.	Type code	Order code	EAN			
20	SCL-A2-20/72	2CSG232075R5011	597001		0.010	10
100	SCL-A2-100/72	2CSG232189R5011	597100		0.010	10
150	SCL-A2-150/72	2CSG232209R5011	597209		0.010	10
200	SCL-A2-200/72	2CSG232229R5011	597308		0.010	10
250	SCL-A2-250/72	2CSG232249R5011	597407		0.010	10
300	SCL-A2-300/72	2CSG232259R5011	597506		0.010	10
400	SCL-A2-400/72	2CSG232279R5011	597605		0.010	10
500	SCL-A2-500/72	2CSG232299R5011	597704		0.010	10
600	SCL-A2-600/72	2CSG232309R5011	597803		0.010	10
800	SCL-A2-800/72	2CSG232329R5011	597902		0.010	10
1000	SCL-A2-1000/72	2CSG232339R5011	598008		0.010	10

Scales 96 x 96 mm, SCL-A2 for AMT2-A2/96 d.c. ammeters

Scale	Order details	Bbn 8012542	Price 1 piece	Price group	Weight 1 piece kg	Pack unit pc.
A d.c.	Type code	Order code	EAN			
20	SCL-A2-20/96	2CSG233075R5011	598107		0.010	10
100	SCL-A2-100/96	2CSG233189R5011	598206		0.010	10
150	SCL-A2-150/96	2CSG233209R5011	598305		0.010	10
200	SCL-A2-200/96	2CSG233229R5011	598404		0.010	10
250	SCL-A2-250/96	2CSG233249R5011	598503		0.010	10
300	SCL-A2-300/96	2CSG233259R5011	598602		0.010	10
400	SCL-A2-400/96	2CSG233279R5011	598701		0.010	10
500	SCL-A2-500/96	2CSG233299R5011	598800		0.010	10
600	SCL-A2-600/96	2CSG233309R5011	598909		0.010	10
800	SCL-A2-800/96	2CSG233329R5011	599005		0.010	10
1000	SCL-A2-1000/96	2CSG233339R5011	599104		0.010	10



Caps and terminal covers

Providing protection against accidental bumping or contact, they also assure a degree of protection to IP55.

They come in three standard sizes, 48 mm x 96 mm, 72 mm x 72 mm and 96 mm x 96 mm.

Size	Description	Order details	Bbn 8012542	Price 1 piece	Price group	Weight 1 piece	Pack unit
mm		Type code	Order code	EAN		kg	pc.

Caps

48 x 96	Trasparent cover IP55 for instruments	COP-48-96	2CSG300000R5041	611608			1
72 x 72	Trasparent cover IP55 for instruments	COP-72	2CSG400000R5041	611707			1
96 x 96	Trasparent cover IP55 for instruments	COP-96	2CSG500000R5041	611806			1

Size	Description	Order details	Bbn 8012542	Price 1 piece	Price group	Weight 1 piece	Pack unit
mm		Type code	Order code	EAN		kg	pc.

Terminal covers

48 x 48	Terminal cover	COP-M-48	2CSG300000R5051	619901			1
72 x 72	Terminal cover	COP-M-72	2CSG400000R5051	620006			1
96 x 96	Terminal cover	COP-M-96	2CSG500000R5051	620105			1

Digital instruments

The wide range of digital instrument starts with single phase instrument, for measuring voltage, current and frequency.

The range is composed by a voltmeter for a.c./d.c. voltage monitoring, two ammeter for a.c. and d.c. current, and frequency meter. Ammeters measure in indirect insertion thanks to measuring accessories, like current transformer for a.c. and shunt for d.c.

The full scale is programmable by the user.

Version	Order details	Bbn	Price	Price	Weight	Pack
	Type code	Order code	1 piece	group	1 piece	unit
					kg	pc.
a.c./d.c. digital voltmeter	VLMD-1-2	2CSM110000R1011	620402		0,300	1
a.c. digital ammeter	AMTD-1	2CSM320000R1011	620501		0,300	1
d.c. digital ammeter	AMTD-2	2CSM420000R1011	620600		0,300	1
Digital frequency meter	FRZ-DIG	2CSM710000R1011	620709		0,300	1

Digital instruments with alarm relay

The range comprises 3 instruments, one voltmeter and two ammeters, that display and monitor a value, tripping a relay contact and signalling the alarm condition if it over- or undershoots a programmable threshold. The alarm threshold as either a minimum or a maximum limit, the peak maximum and minimum values measured are stored in the non volatile instrument memory.

The contact type is NO, so that the contact is open when the instrument is powered off, but it is possible to obtain positive safety operation via a software setting which determines whether the alarm condition is with an open or closed contact.

The instrument with relay can be used as either a minium or maximum relay, but not for both functions simultaneously.

Version	Order details	Bbn	Price	Price	Weight	Pack
	Type code	Order code	1 piece	group	1 piece	unit
					kg	pc.
a.c./d.c. digital voltmeter with alarm relay	VLMD-1-2-R	2CSM274693R1011	746935		0,300	1
a.c. digital ammeter with alarm relay	AMTD-1-R	2CSM274773R1011	747734		0,300	1
d.c. digital ammeter with alarm relay	AMTD-2-R	2CSM261073R1011	610731		0,300	1

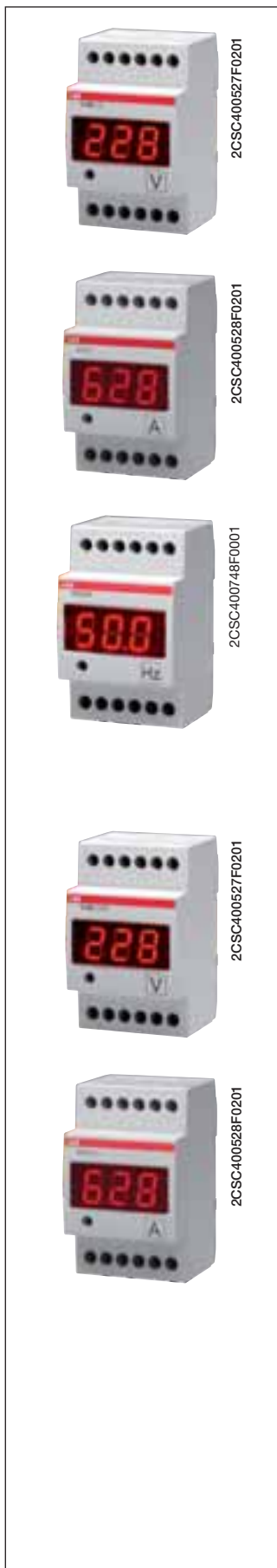

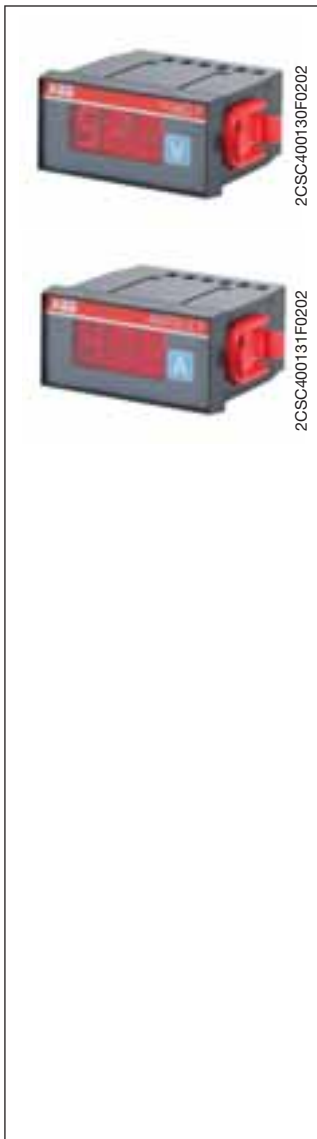

Front panel digital instruments

The wide range of digital instrument starts with single phase instrument, for measuring voltage and current.

The range is composed by a voltmeter for a.c./d.c. voltage monitoring, and two ammeter for a.c. and d.c. current. Ammeters measure in indirect insertion thanks to measuring accessories, like current transformer for a.c. and shunt for d.c.

The full scale is programmable by the user.

Version	Order details	Bbn 8012542	Price 1 piece	Price group	Weight 1 piece kg	Pack unit pc.
	Type code	Order code	EAN			
a.c./d.c. digital voltmeter	VLMD P	2CSG213605R4011	136057		0,300	1
a.c. digital ammeter	AMTD-1 P	2CSG213615R4011	136156		0,300	1
d.c. digital ammeter	AMTD-2 P	2CSG213625R4011	136255		0,300	1

Front panel digital instruments with alarm relay

The range comprises 3 instruments, one voltmeter and two ammeters, that display and monitor a value, tripping a relay contact and signalling the alarm condition if it over- or undershoots a programmable threshold. The alarm threshold as either a minimum or a maximum limit. The peak maximum and minimum values measured are stored in the non volatile instrument memory.

The contact type is NO, so that the contact is open when the instrument is powered off, but it is possible to obtain positive safety operation via a software setting which determines whether the alarm condition is with an open or closed contact.

The instrument with relay can be used as either a minium or maximum realy, but not for both functions simultaneously.

Version	Order details	Bbn 8012542	Price 1 piece	Price group	Weight 1 piece kg	Pack unit pc.
	Type code	Order code	EAN			
a.c./d.c. digital voltmeter with alarm relay	VLMD-R P	2CSG213635R4011	136354		0,300	1
a.c. digital ammeter with alarm relay	AMTD-1-R P	2CSG213645R4011	136453		0,300	1
d.c. digital ammeter with alarm relay	AMTD-2-R P	2CSG213655R4011	136552		0,300	1

Alarm activation logic

Device status	NO polarity (default)	NC polarity
Instrument not supplied		
Instrument supplied - no alarm		
Instrument supplied - alarm condition		

Technical features

Power supply	[V]	230 V a.c.
Rated frequency	[Hz]	50÷60
Ammeter full scale value	[A]	5, 20, 25, 40, 60, 100, 150, 200, 250, 400, 600
Voltmeter full scale value	[V]	300, 500
Frequency meter range	[Hz]	35...400
Tripping delay	[s]	1, 5, 10, 20, 30
Hysteresis	[%]	5, 10, 20, 30 set threshold
Output pins		3-4
Output relay		NO
Rated voltage relay	[V]	230 V a.c.
Rated current relay	[A]	AC1 16, AC15 3
Relay configuration		NO relay closes in alarm status NC relay opens in alarm status, positive safety
Overload	[In/Vn]	1, 2
Accuracy class	[%]	±0,5 full scale ±1digit at 25 °C
Max. signal input value for ammeters		5 A a.c./60 mV d.c.
Display		3 digit LED display
Operating temperature	[°C]	-10...+55
Storage temperature	[°C]	-40...+70
Protection degree		IP20
Power consumption	[VA]	4
Modules		3
Overall dimensions front panel devices	[mm]	36x72x61.5 (51.5 depth inside the switchboard)
Standard		IEC EN 61010

Wiring diagrams for digital instruments, both modular and front panel

VLMD-1-2 and VLMD-1-2-R
VLMD P and VLMD-R P

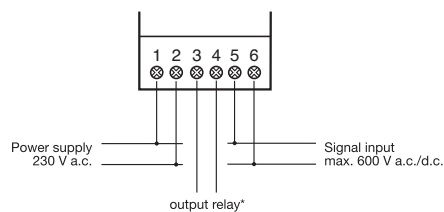

FRZ-DIG

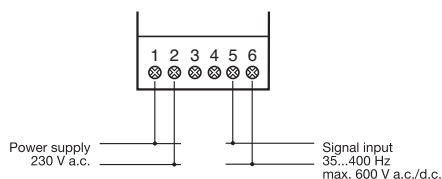

AMTD-1 and AMTD-1-R
AMTD-1 P and AMTD-1-R P

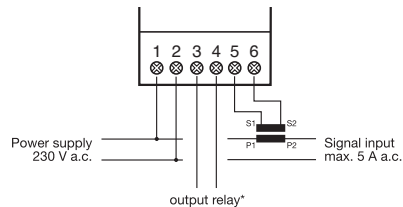

AMTD-2 and AMTD-2-R
AMTD-2 P and AMTD-2-R P

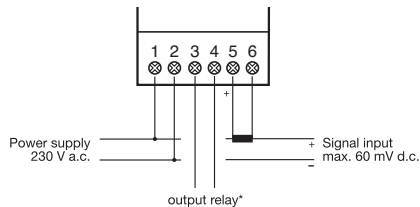

*Only for instruments with output relay

2CSC400132F0202

Digital measurement instruments with relays

Control of a load with the following characteristics:
 $I_n = 5 \text{ A}$ (rated normal operating current)
 $V_n = 230 \text{ V a.c.}$ (rated normal operating voltage)
 $V_{min} = 200 \text{ V a.c.}$ (RLV relay trip)

To scroll through the menu items press briefly (<3sec); to confirm press and hold (>3sec).

- 1 Connect as shown in the diagram ($V_{min} = 200 \text{ V}$).
- 2 Press and hold the key to enter the programming menu.
- 3 Scroll to the ACC menu item and confirm, then choose CC to select direct current operation, and confirm.
- 4 Set the full scale value to 300 V
- 5 Set the alarm threshold at 70 and confirm.
- 6 Adjust the Delay trimmer: scroll to the dLY menu item and confirm, then select the relay tripping delay (1...30 sec).
- 7 Program the alarm reset hysteresis (HySTeresis) at 10% of the threshold: scroll to the HSt menu item, confirm, and select the value 10. This results in a trip window between 200 and 220 V. The relay will be tripped at 200 V and return to normal operation at 220 V.
- 8 Set the alarm output polarity: scroll to the OUt menu item and confirm, then choose whether the contact opens or closes when an alarm is triggered (N.O. by default).

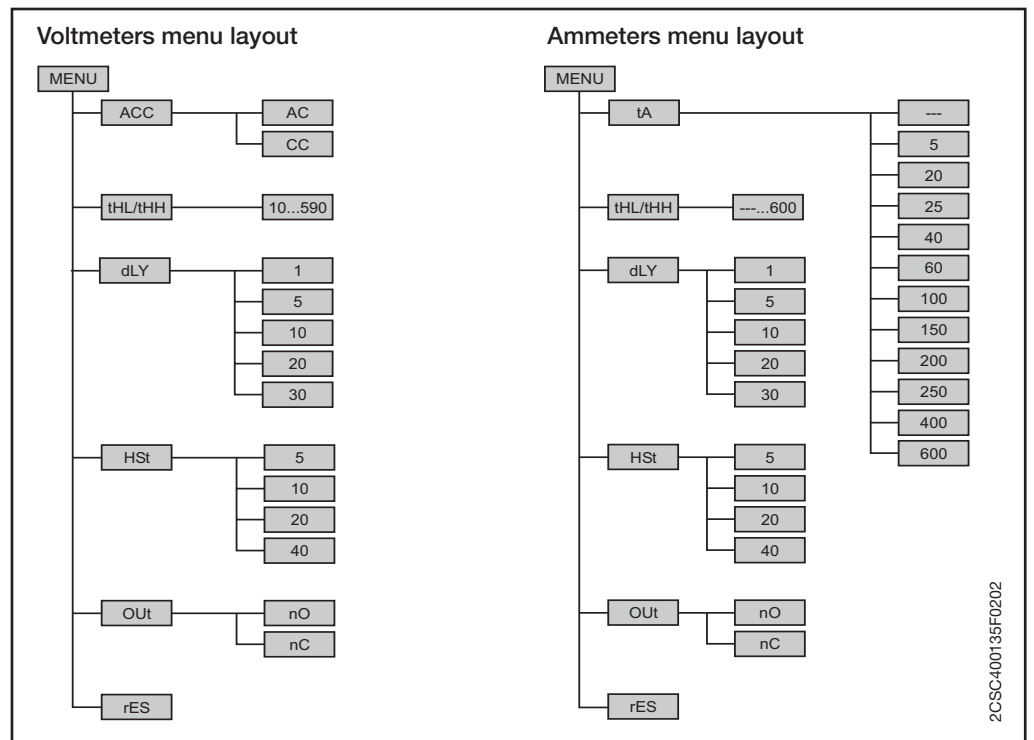
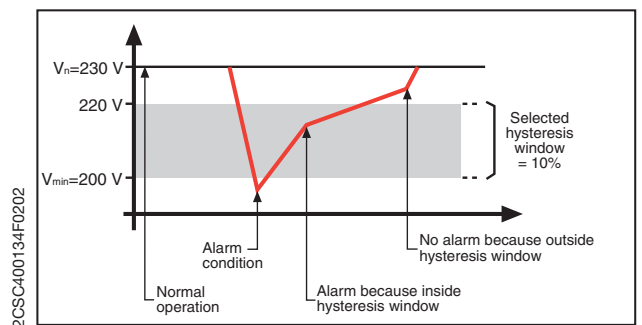
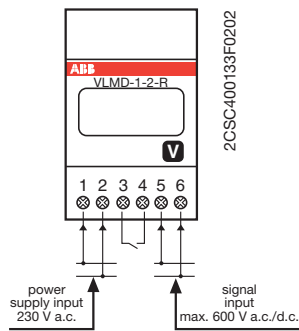



MCV - MCA voltmetric and current switches

Cam rotary switches are suitable for mounting on EN 50022 rail. In three-phase systems they enable the use of a single measurement instrument (single-phase) for viewing the current or voltage value set through the switch itself.

Range	Power loss W	Order details Type code	Order code	Bbn 4034656 EAN	Price 1 piece	Price group	Weight 1 piece kg	Pack unit pc.
-------	-----------------	----------------------------	------------	-----------------------	------------------	----------------	-------------------------	---------------------

Voltmeter switches

L1, L2, L3	0.5	MCV 4	1SCA 022 404 R4740	52246 9			0.095	1
L1, L2, L3, N	0.5	MCV 7	1SCA 022 647 R7840	52243 8			0.110	1

Current switches

0-1-2-3	0.5	MCA 4	1SCA 022 404 R4821	52245 2			0.110	1
---------	-----	--------------	--------------------	----------------	--	--	-------	---

Technical features

Insulation voltage	[V]	600
Rated thermal current	[A]	12
Mechanic operations	[No.]	1000000
Power consumption	[VA]	0.23
Modules	[No.]	3

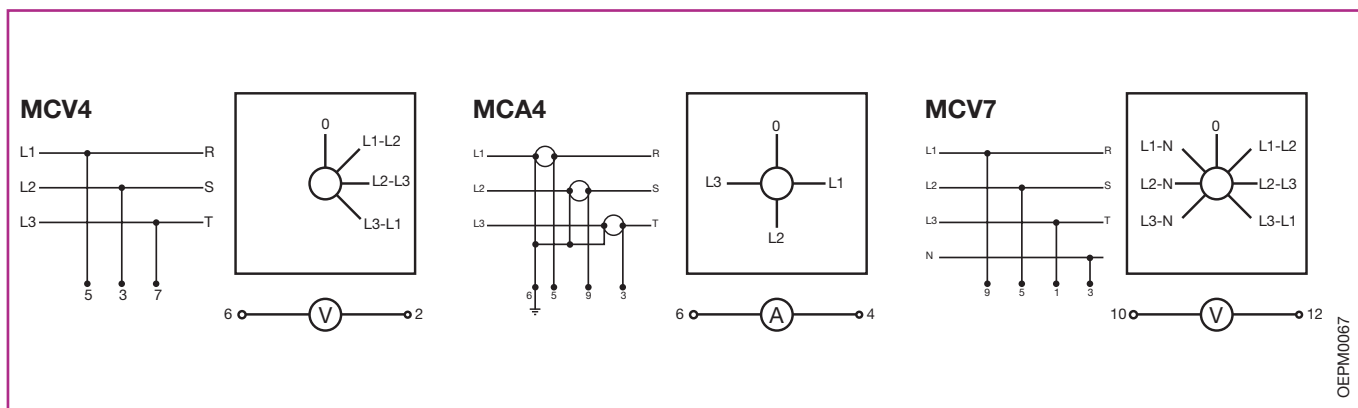



Front panel QCV - QCA voltage and current switches

For use in three-phase systems, to allow a single device to measure the voltage and current settings adjusted by the switches.

Measure	Position	Order details		Bbn 4034656	Price 1 piece	Price group	Weight 1 piece	Pack unit
		Type code	Order code	EAN			kg	pc.
Voltage	4	QCV-4/48	1SCA022780R0770	527990			0.150	1
Current	4	QCA-4/48	1SCA022780R0690	528003			0.150	1
Voltage	7	QCV-7/48	1SCA022780R0850	527983			0.150	1

Wiring diagrams

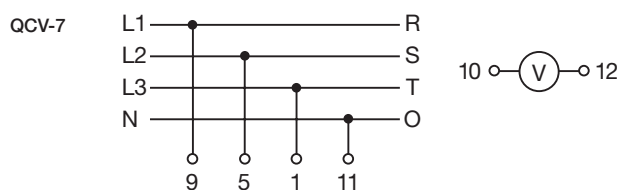
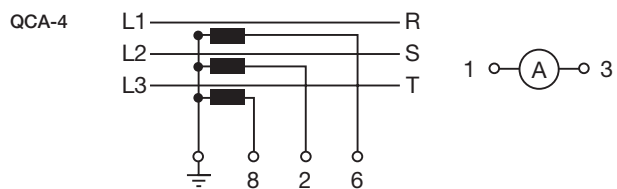
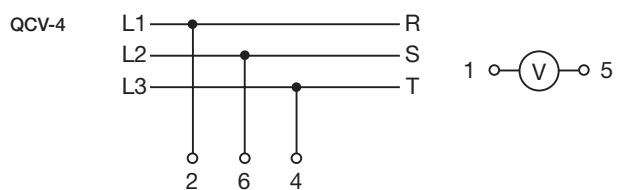

2CSC400136F0202



ODINsingle electronic single phase energy meters

ODINsingle is intended for mounting on a DIN rail and is designed in accordance with the ABB Pro M standard.

General Features

ODINsingle is an active energy, single phase meter for direct metering up to 65A. The LCD display has 6 digits, 6 mm high to ensure easy reading. ODINsingle is made compact, only 2 modules (35 mm) to save space in the installation. A red LED at the front flashes proportionally to the energy consumed. ODINsingle has a temperature range from -25 to +55 (storage +70 °C)

Communication

ODINsingle has 3 ways to communicate depending on type.

- Display at front
- Pulse output (option)
- IR interface for serial communication (together with serial communication adapter)

Type Approval

ODINsingle is type approved according to IEC standards, IEC 62052-11 and IEC 62053-21. ODINsingle is also type approved and verified according to MID (2004/22/EC), EN 50470-1 and EN 50470-3. Verification report is available on request. The standards cover all technical aspects of the meter including climate conditions, electromagnetic compatibility (EMC), electrical and mechanical requirements and accuracy. Technical data according to IEC is written within parenthesis in the Technical features.

Voltage (V)	Pulse output frequency	Order details Type code	Order code	Bbn 7392696 EAN	Price 1 piece	Price group	Weight 1 piece	Pack unit
OD1065 direct connected, single phase meter 65A								
230	-	OD1065	2CMA131040R1000	310406			0.145	1
OD1365 direct connected, single phase meter 65A, pulse output and resetable								
230	100 imp/kWh	OD1365	2CMA131041R1000	310413			0.145	1

8

ODINsingle wiring diagrams

Direct connection

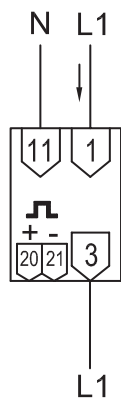

Technical features

Rated voltage Un	[V]	a.c. 230, -23% to +20%
Direct insertion current	[A]	up to 65
Protection fuse	[A]	63
Rated frequency	[Hz]	50 (50/60)
Starting current	[mA]	20
Pulse output frequency	[imp]	100
Pulse output max current	[mA]	100
Pulse output impulse length	[ms]	100
LED frequency	[imp]	1000
LED impulse length	[ms]	40
Accuracy rating	[%]	1
Power consumption	[W]	1.0 VA
Protection degree	[IP]	20
Operating temperature	[°C]	-25 to +55
Modules	[No]	2
Standards		EN 50470-1, EN 50470-3 (IEC 62052-11, IEC 62053-21)

DELTAsingle electronic energy meters

DELTAsingle electronic single phase energy meters

DELTAsingle is an electronic electricity meter for single phase metering. The meter has an internal clock for handling tariffs. The setting is done with push buttons. DELTAsingle is intended for mounting on a DIN rail and is designed in accordance with the ABB ProM standard.

General Features

DELTAsingle is an active energy, single phase meter for direct metering up to 80 A. The LCD display has 6 digits, 6 mm high to ensure easy reading.

DELTAsingle is made compact, only 4 modules (72 mm) to save space in the installation.

In case of power failure, the meter is equipped with a Super Cap power backup that will run the clock for 48 hours. A red LED at the front flashes proportionally to the energy consumed.

DELTAsingle has a temperature range from -40 to +55 (storage +70 °C)

Communication

DELTAsingle has 3 ways to communicate depending on type.

- Display at front
- Pulse output
- IR interface for serial communication (together with serial communication adapter)

Programming

Selection of information to be shown on the display is easily achieved by using push buttons. The programming / push button can be sealed.

Tariffs

The DELTAsingle range includes 1, 2 and 4 tariffs meters.

Type Approval

DELTAsingle is type approved according to IEC standards, IEC 62052-11 and IEC 62053-21.

DELTAsingle is also type approved and verified according to MID (2004/22/EC), EN 50470-1 and EN 50470-3. Verification report is available on request. The standards cover all technical aspects of the meter including climate conditions, electromagnetic compatibility (EMC), electrical and mechanical requirements and accuracy. Technical data according to IEC is written within parenthesis in the Technical features.



2CSC400142F0201

Description	Order details		Bbn 7392696 EAN	Price 1 piece	Price group	Weight 1 piece kg	Pack unit pc.
	Type code	Order code					
1 tariff without pulse output	FBU 11200	2CMA180891R1000	808910			0.150	1
1 tariff with pulse output	FBB 11200	2CMA180892R1000	808927			0.150	1
2 tariff without pulse output	FBU 11205	2CMA180893R1000	808934			0.150	1
2 tariff with pulse output	FBB 11205	2CMA180894R1000	808941			0.150	1
4 tariff without pulse output	FBU 11206	2CMA180895R1000	808958			0.150	1
4 tariff with pulse output	FBB 11206	2CMA180896R1000	808965			0.150	1

Technical features

General features

Voltage	[V]	230 AC
Voltage range		-23 % to +20 %
Max current	[A]	80
Start current	[mA]	40
Power consumption of current circuit	[VA]	< 1.3
Frequency	[Hz]	50 (50/60) ± 5 %
Accuracy of measurement		± 1 %
Memory backup		EEPROM
Clock backup		Super Cap. 48h
Clock accuracy		IEC 62054-21
Standard		EN 50470-1 and EN 50470-3 (IEC 62052-11 and IEC 62053-21)
Temperature range	[°C]	-40 to +55
Material of front cover		Polycarbonate
Material of back cover		Polycarbonate/glass fibre
Resistance to heat and fire		IEC 60695-2-10
Protection against penetration of dust and water	[IP]	20
Connection area in the current connecting terminals	[mm ²]	1 - 25
Weight	[gr]	150

Pulse output

Connection area in the connecting terminal	[mm ²]	0.5 - 2.5
External pulse voltage	[V]	5 - 40 DC
Max. current	[mA]	100
Pulse length	[ms]	100
Pulse frequency		100 imp/kWh
Standard		IEC 62053-31 (S0)

LED

Pulse frequency		1000 imp/kWh
Pulse length	[ms]	40

Display

LCD with 6 digits, 6 mm

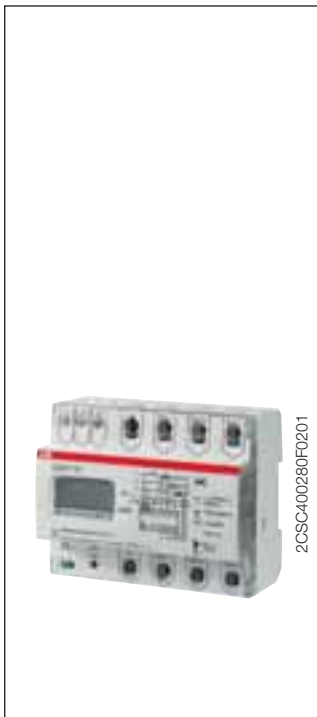

2CSC400280F0201

ODIN Meter electronic three-phase energy meters

ODIN Meter is a compact three-phase meter for measuring active energy, designed for mounting on DIN rail, on panel and for flush mounting in distribution switchboard or standard boxes. It is designed and developed to offer extremely easy application and it is equipped with terminals with transparent scores and strong holding screws for connecting cables and terminal boards, phase bus connectors, easy to read 7-digit display, current direction indicator, clear mounting instructions with text and diagrams on the device. ODIN Meter is a highly reliable and strong meter that maintains the highest measuring accuracy in time.

Type Approval

ODIN is type approved according to IEC standards, IEC 62052-11 and IEC 62053-21. ODIN is also type approved and verified according to MID (2004/22/EC), EN 50470-1 and EN 50470-3. Verification report is available on request. The standards cover all technical aspects of the meter including climate conditions, electromagnetic compatibility (EMC), electrical and mechanical requirements and accuracy. Technical data according to IEC is written within parenthesis in the Technical features.

Active energy meter 3x230/400 (three-phase+N)

Description	Order details	Order code	Bbn	Price 1 piece	Price group	Weight 1 piece kg	Pack unit pc.
	Type code		EAN				
direct up to 65A, impulsive output 100 Imp./kWh	OD4165	2CMA131024R1000	7392696 310246			0.38	1
indirect with CT/5A, impulsive output 10 Imp./kWh	OD4110	2CMA131025R1000	310253			0.40	1

ODIN series wiring diagrams

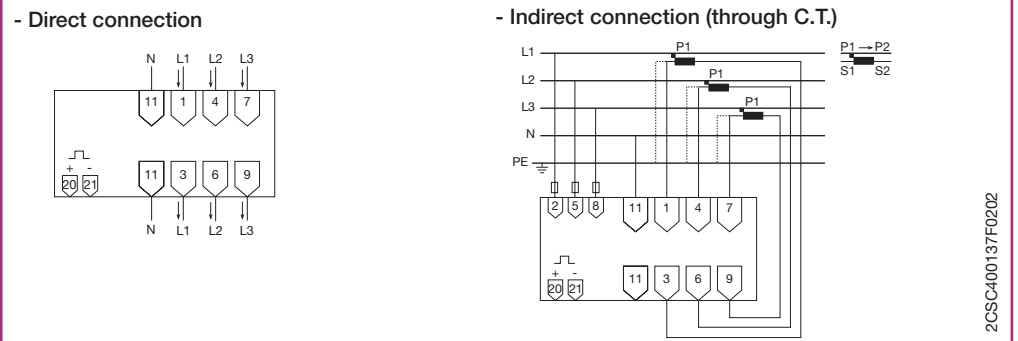

2CSC400137F0202

Technical features

	Direct measuring/connection	Connection through A.T.
Voltage	3x230/400 V, -20% to +15%	3x230/400 V, -20% to +15%
Current	65 A	10 A
Frequency	50 (50/60) Hz	50 (50/60) Hz
Selection of insertion currents through C.T.		5/5, 75/5, 100/5, 150/5, 200/5, 250/5, 300/5, 400/5, 500/5, 600/5, 700/5, 750/5, 800/5, 900/5 A
Starting current	25 mA	15 mA
Pulse output voltage	5...40 V	...40 V
Pulse output max. current	100 mA	100 mA
Pulse output impulse length	100 ms	100 ms
Pulse output frequency	100 imp/kWh	10 imp/kWh
LED frequency	100 imp/kWh	1000 imp/kWh
LED pulse length	40 ms	40 ms
Accuracy rating	±2%	±2%
Display	7-digit LCD	7-digit LCD
Protection degree	IP 20	IP 20
Operating temperature	-25 + 55 °C	25 + 55 °C
Standards	EN 50470-1, EN 50470-3 IEC 62052-11 and IEC 62053-21	EN 50470-1, EN 50470-3 IEC 62052-11 and IEC 62053-21



DELTAplus electronic three-phase energy meters

DELTAplus meters are designed to offer extremely easy and simple application. Suitable for mounting on DIN rail, lightweight and small, they are ideal for the installation on switchboards, feeder panels and enclosed. The range includes devices for measuring active energy, and the combination of active and reactive energy.

Type Approval

DELTAplus is type approved according to IEC standards, IEC 62052-11 and IEC 62053-21 (IEC 62053-23). DELTAplus is also type approved and verified according to MID (2004/22/EC), EN 50470-1 and EN 50470-3. Verification report is available on request. The standards cover all technical aspects of the meter including climate conditions, electromagnetic compatibility (EMC), electrical and mechanical requirements and accuracy. Technical data according to IEC is written within parenthesis in the Technical features.

Description	Order details	Bbn	Price	Price	Weight	Pack
	Type code	Order code	1 piece	group	1 piece	unit
					kg	pc.

Energy meters for direct connection up to 80 A, class 2

3 x 100-500 V AC (3P)	DBB 22000	2CMA180802R1000	808026		0.338	1
3 x 57-288/100-500 VAC (3P+N)	DBB 23000	2CMA180800R1000	808002		0.338	1
3 x 57-288/100-500 VAC (3P+N) + active/reactiv	DDB 13000	2CMA180810R1000	808101		0.338	1

Energy meters for connection through C.T. /5 A, class 2

3 x 100-500 V AC (3P)	DAB 12000	2CMA180807R1000	808071		0.304	1
3 x 57-288/100-500 VAC (3P+N)	DAB 13000	2CMA180806R1000	808064		0.304	1
3 x 57-288/100-500 VAC (3P+N) + active/reactiv	DCB 13000	2CMA180808R1000	808088		0.304	1

DELTAmax advanced electronic three-phase energy meter

DELTAmax is a further enhancement of DELTAplus. Additional features for DELTAmax are:

Four quadrant metering (import and export of energy)

Time dependent functions including

- Load profile (15, 30, 60 min interval)
- Max demand
- Event and quality logs
- Monthly or Daily values (selectable)

Total Harmonic Distortion (THD) up to 9th harmonic (50 Hz network)

Type Approval

DELTAmax is type approved according to IEC standards, IEC 62052-11 and IEC 62053-21 (IEC 62053-23). DELTAmax is also type approved and verified according to MID (2004/22/EC), EN 50470-1 and EN 50470-3. Verification report is available on request. The standards cover all technical aspects of the meter including climate conditions, electromagnetic compatibility (EMC), electrical and mechanical requirements and accuracy. Technical data according to IEC is written within parenthesis in the Technical features.

Description	Order details	Bbn	Price	Price	Weight	Pack
	Type code	Order code	1 piece	group	1 piece	unit
					kg	pc.

Energy meters for direct connection up to 80 A

3x57-288/100-500 VAC (3P+N)	DFB 13007	2CMA139504R1000	395045			
3x57-288/100-500VAC (3P+N) + M-Bus	DFM 13007	2CMA139507R1000				
3x100-500 VAC (3P) + M-Bus	DFM 12007	2CMA139508R1000				
3x57-288/100-500 VAC (3P+N) + active/reactive	DHB 13007	2CMA139520R1000				



Description	Order details		Bbn 7392696	Price 1 piece	Price group	Weight 1 piece kg	Pack unit pc.
	Type code	Order code					

Energy meters for connection through C.T. /5A

3x57-288/100-500 VAC (3P+N)	DEB 13007	2CMA139497R1000
3x57-288/100-500VAC (3P+N) + M-Bus	DEM 13007	2CMA139500R1000
3x100-500 VAC (3P) + M-Bus	DEM 12007	2CMA139549R1000
3x57-288/100-500 VAC (3P+N) + active/reactive	DGB 13007	2CMA139511R1000

Auxiliary elements/accessories

Long cover	DELTA/CPL	2CMA132633R1000	326339	1
DIN rail	DELTA/DIN	2CMA132540R1000	325400	1
Front mounting kit	DELTA/FRQ	2CMA132635R1000	325417	1

Technical features - DELTAplus and DELTAmax

Voltage	[V]	3 x 57-288 / 100-500 (4-wire, 3-element) 3 x 100-500 (3 wire, 2-element) 1 x 57-288 (Single phase)
Current	[A]	≤80 (direct connection); ≤6 (indirect connection through C.T.)
Frequency	[Hz]	50 (50/60)
Starting current	[mA]	20 (direct connection), 2 (C.T. connection)
Pulse output frequency	[imp/kWh]	programmable
Pulse output impulse length	[ms]	100
LED frequency	[imp/kWh]	1000 (direct connection), 5000 (C.T. connection)
Pulse output		
-max. current	[mA]	100
-max. voltage	[Va.c./d.c.]	247
-max. cable section	[mm ²]	2.5
-standards		IEC 62053-31 for pulse output
Standards		EN 50470-1 and EN 50470-3 (IEC 62052-11 and IEC 62053-21 for active energy meters; IEC 62053-23 for reactive energy meters)
Accuracy		1 or 2%
Display		LCD (liquid crystal) with 7 digits, h=7mm
Terminal holder		10 mm ² (insertion through C.T.); 25 mm ² (direct insertion)
Protection degree		IP51 (IP20 on the terminal holder without cover)
Operating temperature	[°C]	-40 +70
Power consumption		<1 VA, 1 W
Modules	[No]	7

Wiring diagrams - DELTAplus and DELTAmax

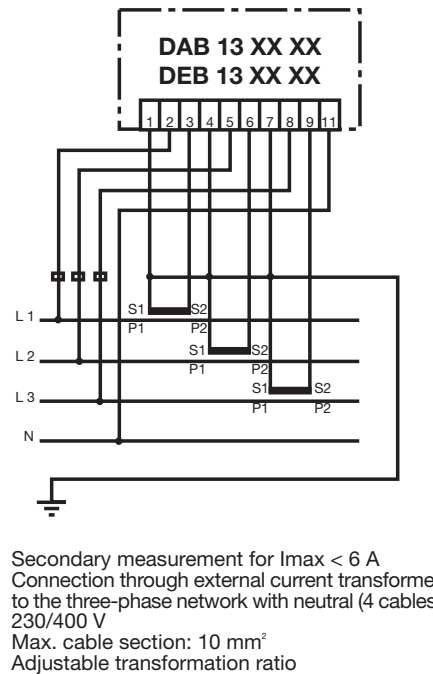
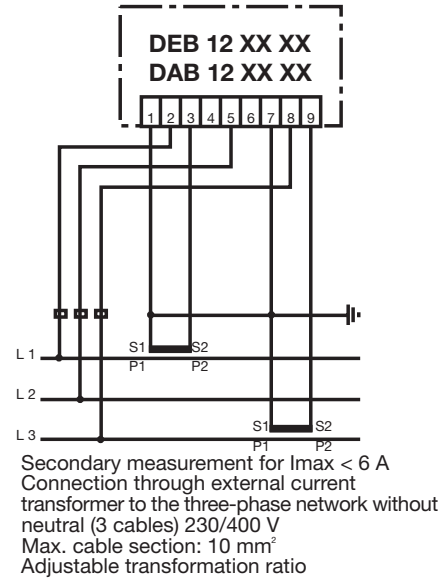
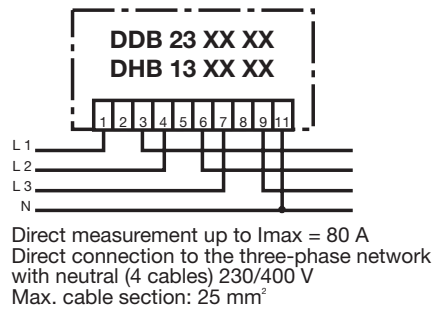
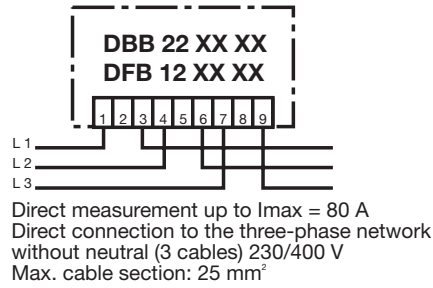

Notes

For connections through current transformer, C.T. must have 5 A or 1 A secondary and be connected according to correct polarities: P1->P2, S1->S2

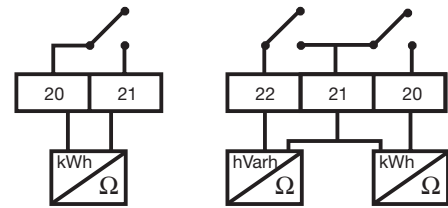

2-pole balanced or 3-pole unbalanced output for sending to a personal computer information from energy meter, encoded as numerical signal. Some types enable to connect an external voltage to control teaset

OEPM0077



2CNC480005F0006

Module	Protocol/Media	Order details		Bbn	Price	Price	Weight	Pack
		Type code	Order code	7392696	1 piece	group	1 piece	unit
				EAN			kg	pc.

Serial Communication Adapter

M-bus	M-Bus/M-Bus	CTM 04000	2CMA137090R1000	370905			0.090	1
RS232	M-Bus/RS232 Twisted pair	CRM 04000	2CMA137091R1000	370912			0.090	1
Ethernet	M-Bus over TCP or UDP, built in web- server	CEM 05100	2CMA137121R1000				0.090	1
EIB/KNX	EIB/KNX/Twisted Pair	ZS/S	2CDG110083R1011				0.100	1

SCA GSM/GPRS M-bus

The GSM/GPRS communication adapter is a quad band GSM/GPRS device, which enables AMR with GSM or GPRS over GSM 850/900 and GSM 1800/1900 networks. Further more the ABB GSM/GPRS communication adapter support remote configuration using Short Message Service (SMS) and Over The Air (OTA) downloading of application, which provides flexible configuration and easy upgrading of the adapter. The adapter is powered with 100-240 VAC (-15/+10%).

Module	Protocol/Media	Order details		Bbn	Price	Price	Weight	Pack
		Type code	Order code	7392696	1 piece	group	1 piece	unit
				EAN			kg	pc.

Serial Communication Adapter

GSM/GPRS	M-Bus over CSD/GSM M-Bus over TCP or UDP/GPRS	CGM 05000	2CMA137104R1000	371049			0.105	1
----------	---	------------------	-----------------	---------------	--	--	-------	---

SCA M-bus extender

The CMM 05000 is an M-Bus over IR to M-Bus 2-wire communication module. The CMM 05000 gives the possibilities to connect up to 32 M-Bus slaves to one serial communication adapter. The module is mounted between a serial communication adapter (e.g. CEM 05100 or CGM 05000) and the meter.

Module	Protocol/Media	Order details		Bbn	Price	Price	Weight	Pack
		Type code	Order code	7392696	1 piece	group	1 piece	unit
				EAN			kg	pc.

Serial Communication Adapter

M-Bus extender	M-Bus over IR/ M-Bus over TP	CMM 05000	2CMA137120R1000	371209			0.105	1
-------------------	---------------------------------	------------------	-----------------	---------------	--	--	-------	---

MID - Measuring Instrument Directive

From October 30, 2006 common rules applies in European Union for electricity meters for domestic, business and light industry through the measurement instruments directive (MID). ABB and its accredited laboratory (SE1818) are certified to performed first time verification of Active Electrical Energy Meters (MI-003) according to Annex D and the equivalent clauses of ISO 9001.

The MID approvals are automatically valid in the entire EU and EEA. All our meters are type approved according to standards EN 50470-1 and EN 50470-3.

MID approved and verified products are marked with the MID symbol (e.g. CE M09 0122) on the product and packaging label.



E 233 electro-mechanical hour counters

Hour counters are used to record operating times as well as to determine idle times and off times of industrial machinery and plant, for commercial purposes or in domestic installations. No reset functionality.

Rated voltage	Order details		Bbn 4012233 EAN	Price 1 piece	Price group	Weight 1 piece kg	Pack unit pc.
	Type code	Order code					
AC 230 V/50 Hz	E 233-230	2CDE100000R1601	63000 4			0.05	10
AC 24 V/50 Hz	E 233-24	2CDE400000R1601	63010 3			0.05	10
DC 12 V ... 48 V	E 233-12/48	2CDE300010R1601	63020 2			0.05	10
AC 240 V/60 Hz	E 233-240/60 Hz*	2CDE100021R1601	36590 1 ①			0.05	10
AC 120 V/60 Hz	E 233-120/60 Hz*	2CDE600021R1601	36600 7 ①			0.05	10
AC 24 V/60 Hz	E 233- 24/60 Hz*	2CDE400021R1601	36610 6 ①			0.05	10

Other rated voltages upon request.

① Bbn No. 40 16779

* U_L approval

8

Wiring diagram

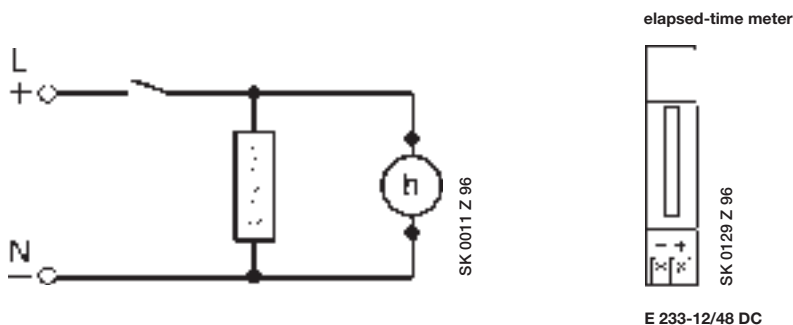

Technical features

	AC equipment	DC equipment
Rated voltage	50 Hz: 24 V, 230 V 60 Hz: 24 V, 120 V, 240 V*	DC 12 V ... 48 V
Voltage tolerance	±15 %	±10 %
Power consumption	1.5 VA	ca. 20 mW (at 12 V DC)
Ambient temperature	-15 °C/5 °F... +50 °C/122 °F	-10 °C/14 °F ... +50 °C/122 °F
Counting capacity	99.999 h	99.999 h
Precision class	0.01 h	0.1 h
Operation display	fast running	LED blinking
Protection against electric shock	according to DIN VDE 0106 Part 100 (BGV A2)	according to DIN VDE 0106 Part 100 (BGV A2)
Terminal size	up to 10 mm ²	up to 10 mm ²

* U_L approval



HMT electro-mechanical hour counters

Equipped with 7-digit indicator (99.999,99) and available in two modules. They cannot be reset.

Rated voltage V AC	Order details Type code	Order code	Bbn 8012542 EAN	Price 1 piece	Price group	Weight 1 piece kg	Pack unit pc.
24	HMT 1/24	2CSM111000R1601	030300			0.200	6
110	HMT 1/110	2CSM121000R1601	030409			0.200	6
220	HMT 1/220	2CSM131000R1601	030508			0.200	6
230	HMT 11	2CSM133000R1601	030607			0.200	1

Wiring diagram

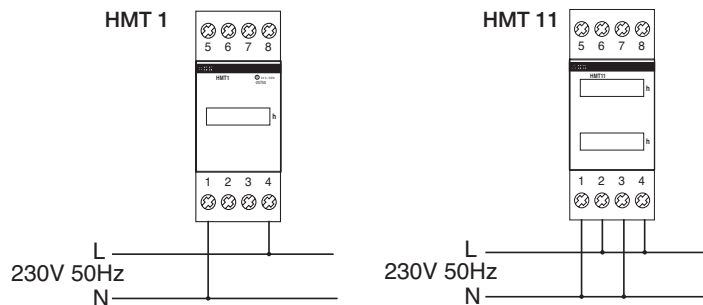

Technical features

Rated voltage Un	[V]	a.c. 24 a.c. 110 a.c. 230 d.c. 12...48
Displayed digits (in hours)	[n°]	99,999.9 (for HMT1 and HMT11)
Accuracy class	[%]	0.5
Frequency	[Hz]	50
Power consumption	[W]	1.1...2.2
Modules	[No.]	2

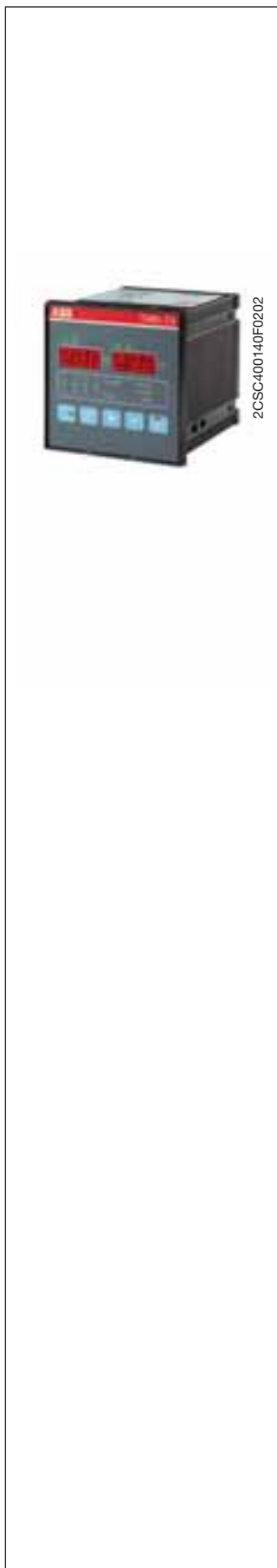

Temperature control units

TMD are used measure and control the temperature levels and efficiency of electric machines, power transformers, motors, etc.

The temperature is measured by four PT100 type sensors. Each measuring channel has two programmable alarm thresholds which trip two output relays to remotely signal that a critical temperature has been reached.

The measured values and any alarm conditions are shown on the dual 3-digit display on the front of the device, which also has five programming keys for configuring its operation.

The control unit is also able to store in memory maximum values and a log of all trip-events.

Temperature measured	Order details Type code	Order code	Bbn 8012542 EAN	Price 1 piece	Price group	Weight 1 piece kg	Pack unit pc.
4	TMD-4/96	2CSG524000R2021	560203			0.8	1

Technical features

Auxiliary supply	Alternating current [V]	20÷250 ±15%
	Direct current [Hz]	115-230-400 50-60
Power consumption	[VA]	4 max
Input	Sensor	PT100 RTD (not included)
	Type	3 wires (2 and 4 wires types are also supported)
	Error	1 degree every 0,39 Ω
	Measure range [°C]	0...220 ± 2
	Compensation [Ω]	20 max
	Trip delay/hysteresis [s/°C]	5/2
Output	Number	4
	Type	NO-CO-NC
	Vmax [V]	12 d.c.
	Imax [A]	8 (resistive load)
	Functions	Alarm, trip, cooling, auto-test
	Programmable functions	Alarm, tip, hold, fan, temp. max
Display		7 segments LED
Connections	Terminals	removable screw
	Max section [mm²]	2.5
Insulation voltage	[V]	2500/50 Hz - 1 min
Protection degree	Front	IP52
	Rear	IP20
Operation temperature	[°C]	-10...+55, relative humidity max 90%
Storage temperature	[°C]	-25...+80
Reference		IEC EN 50081-2, IEC EN 50082-2, IEC EN 60255

Measurement modular current transformers



Modular current transformers with Ø 29 mm through primary, secondary .../5A

TRF M are modular current transformers with through primary for measuring instruments. Their compact size and quick DIN rail plug allow easy installation along with great measurement precision.

Primary rated current I _{prim}	Accuracy class	Rated power VA	Order details	Bbn 8012542	Price 1 piece	Price group	Weight 1 piece	Pack unit
A		VA	Type code	Order code	EAN		kg	pc.
40	3	1	TRFM/40	2CSM100050R1111	046912		0.721	4
60	1	2	TRFM/60	2CSM100070R1111	047018		0.744	4
100	0.5	2	TRFM/100	2CSM100090R1111	047117		0.744	4
150	0.5	3	TRFM/150	2CSM100100R1111	047216		0.712	4
250	0.5	4	TRFM/250	2CSM100120R1111	047315		0.746	4
400	0.5	6	TRFM/400	2CSM100140R1111	047407		0.780	4
600	0.5	7	TRFM/600	2CSM100160R1111	047506		0.859	4

Technical features

Frequency	50÷60 Hz
Insulation reference voltage	0,72 kV
Test voltage	3 kV x 1' 50 Hz
Insulation class	B
Protection degree	IP20
Permanent overcurrent	1,2 I _n
Thermal short-time current	40 I _n
Operating temperature	-25 ÷ +50 °C
Storage temperature	-40 ÷ + 80 °C
Reference standards	IEC EN 60044-1, IEC 61010-1

CT and CTA current transformers

Used to transform primary currents (max. 6000 A) into .../5 A low secondary currents indirectly supplying power to analogue and digital measurement devices. They are available both with wound and through primary. In the first case they are provided along with the bar or the primary terminal; in the second case they have a hole to insert in the bar or the cable which forms the primary.

Technical features

Standard secondary current	[A]	5
Max. voltage for operation ①	[kV]	1.2
Test voltage ②	[kV]	6 at 50 Hz/1 min.
Short circuit rated thermal current I_{min} ③	[IpN]	40 for 1 sec.
Short circuit rated dynamic current I_{min} ④	[I _{red}]	2.5 for 1 sec.
Permanent overload	[IpN]	1.2
Safety factor ⑤	[Fs]	≤2 at ≤10 according to version and capacity
Frequency	[Hz]	50/60
Air insulation		E class
Terminals ⑥		primary = P1, P2 (K-L) secondary = s1, s2 (k-l) P1 (K)=primary wound input P2 (L)=primary wound output s1 (k)=secondary wound input s2 (l)=secondary wound output with double ration on secondary s1-s2=lower ratio, s1-s3=higher ratio
Housing		ABS resin
Protection degree		IP30
Operating temperature	[°C]	-20...+50
Max. temperature on bars	[°C]	+70
Storage temperature	[°C]	-40...+80
Relative humidity		80%
Reference standard		EN 61010, IEC-EN 60044-1

① Max. voltage (effective value) the transformer can bear.

② Industrial frequency voltage in relation to insulation the transformer bears for 1 min. between the primary and the secondary.

③ Max. primary current (effective value) the transformer bears for 1 sec. with counter-circuited secondary without overload-induced damages.

④ Max. primary current (effective value) the transformer bears for 1 sec. with counter-circuited secondary without damaged due to electromagnetic efforts.

⑤ Ratio between primary current causing nucleus saturation and the rated primary current value: the lower the Sf the higher the protection level on the transformer.

⑥ Brass terminals CuZn37, M4x6 screws with torsion value 1.9 Nm, tensile value 440 N/mm² and elasticity limit 340 N/mm².

During the installation control the correct input (P1-K) and output (P2-L) direction of the primary cable.

On versions with primary and secondary on terminals pay attention the connection of the primary with the secondary is not inverted.

In the case of a detachment from measurement devices of the transformer in a connected plant counter-circuit the two terminals of the transformer.

It is suggested to earth the transformers.

Measurement current transformers with wound primary

Standard type current transformers .../5 A with wound primary

Primary rated current I _{prim}	Accuracy class	Rated power	Order details	Bbn 8012542	Price 1 piece	Price group	Weight 1 piece	Pack unit
A	VA	Type code	Order code	EAN			kg	pc.

CTA .../5 A series, wound primary with insertion on Ø8 MA bolt

Primary rated current I _{prim}	Accuracy class	Rated power	Type code	Order code	EAN	Weight 1 piece	Pack unit
5	0.5	5	CTA/5	2CSG111020R1141	661306	0.290	1
10	0.5	5	CTA/10	2CSG111030R1141	661405	0.290	1
15	0.5	5	CTA/15	2CSG111040R1141	661504	0.290	1
20	0.5	5	CTA/20	2CSG111050R1141	661603	0.290	1
25	0.5	5	CTA/25	2CSG111060R1141	661702	0.290	1
40	0.5	5	CTA/40	2CSG111080R1141	661801	0.290	1
50	0.5	5	CTA/50	2CSG111090R1141	661900	0.290	1
60	0.5	5	CTA/60	2CSG111100R1141	662006	0.290	1
80	0.5	5	CTA/80	2CSG111110R1141	662105	0.290	1
100	0.5	5	CTA/100	2CSG111120R1141	662204	0.290	1

CTA1 .../5 A series, wound primary with insertion on 25 mm bar

Primary rated current I _{prim}	Accuracy class	Rated power	Type code	Order code	EAN	Weight 1 piece	Pack unit
5	0.5	10	CTA1/5	2CSG211020R1141	662303	0.440	1
10	0.5	10	CTA1/10	2CSG211030R1141	662402	0.440	1
15	0.5	10	CTA1/15	2CSG211040R1141	662501	0.440	1
20	0.5	10	CTA1/20	2CSG211050R1141	662600	0.440	1
25	0.5	10	CTA1/25	2CSG211060R1141	662709	0.440	1
40	0.5	10	CTA1/40	2CSG211080R1141	662808	0.440	1
50	0.5	10	CTA1/50	2CSG211090R1141	662907	0.440	1
60	0.5	10	CTA1/60	2CSG211100R1141	663003	0.440	1
80	0.5	10	CTA1/80	2CSG211110R1141	663102	0.440	1
100	0.5	10	CTA1/100	2CSG211120R1141	663201	0.440	1
150	0.5	10	CTA1/150	2CSG211130R1141	663300	0.440	1
200	0.5	10	CTA1/200	2CSG211140R1141	663409	0.440	1
250	0.5	10	CTA1/250	2CSG211150R1141	663508	0.440	1
300	0.5	10	CTA1/300	2CSG211160R1141	663607	0.440	1
400	0.5	10	CTA1/400	2CSG211170R1141	663706	0.440	1
500	0.5	10	CTA1/500	2CSG211180R1141	663805	0.440	1

CTA2 .../5 A series, wound primary with insertion on 25 mm bar

Primary rated current I _{prim}	Accuracy class	Rated power	Type code	Order code	EAN	Weight 1 piece	Pack unit
5	0.5	20	CTA2/5	2CSG311020R1141	663904	0.440	1
10	0.5	20	CTA2/10	2CSG311030R1141	664000	0.440	1
15	0.5	20	CTA2/15	2CSG311040R1141	664109	0.440	1
20	0.5	20	CTA2/20	2CSG311050R1141	664208	0.440	1
25	0.5	20	CTA2/25	2CSG311060R1141	664307	0.440	1
40	0.5	20	CTA2/40	2CSG311080R1141	664406	0.440	1
50	0.5	20	CTA2/50	2CSG311090R1141	664505	0.440	1
60	0.5	20	CTA2/60	2CSG311100R1141	664604	0.440	1
80	0.5	20	CTA2/80	2CSG311110R1141	664703	0.440	1
100	0.5	20	CTA2/100	2CSG311120R1141	664802	0.440	1
150	0.5	20	CTA2/150	2CSG311130R1141	664901	0.440	1
200	0.5	20	CTA2/200	2CSG311140R1141	665007	0.440	1
250	0.5	20	CTA2/250	2CSG311150R1141	665106	0.440	1
300	0.5	20	CTA2/300	2CSG311160R1141	665205	0.440	1
400	0.5	20	CTA2/400	2CSG311170R1141	665304	0.440	1
500	0.5	20	CTA2/500	2CSG311180R1141	665403	0.440	1

CTA series
Wound primary max section [mm]

cable	○	8
horizontal bar	▬	-
vertical bar	▮	-



CTA/25 2CSC400213F0201 CTA/40 2CSC400214F0201

CTA1 series
Wound primary max section [mm]

cable	○	-
horizontal bar	▬	25
vertical bar	▮	-



CTA1 2CSC400214F0201

CTA2 series
Wound primary max section [mm]

cable	○	-
horizontal bar	▬	25
vertical bar	▮	-



CTA2 2CSC400214F0201



System pro M compact® Selection tables

Measurement devices

Current transformers

CT



Breaker choice

 Modular	S200, S500 S280, S800							
 Tmax	T1, T2, T3, T4	T5			T6, T7			
 Emax			E1, E2	E1 E2	E1	E2, E3, E4, E6	E3, E4	

Rated current choice

Rated Current [A]	CT3	CT4	CT6	CT8	CT8-V	CT12	CT12-V	
40	2CSG121060R1101 CT3/40							3
50	2CSG121070R1101 CT3/50							3
60	2CSG121080R1101 CT3/60							3
80	2CSG121090R1101 CT3/80							3
100	2CSG121100R1101 CT3/100	2CSG221100R1101 CT4/100						1
150	2CSG121110R1101 CT3/150	2CSG221110R1101 CT4/150						0.5
200	2CSG121120R1101 CT3/200	2CSG221120R1101 CT4/200						0.5
250	2CSG121130R1101 CT3/250	2CSG221130R1101 CT4/250	2CSG421130R1101 CT6/250					0.5
300	2CSG121140R1101 CT3/300	2CSG221140R1101 CT4/300	2CSG421140R1101 CT6/300	2CSG521140R1101 CT8/300				0.5
400		2CSG221150R1101 CT4/400	2CSG421150R1101 CT6/400	2CSG521150R1101 CT8/400	2CSG631150R1101 CT8-V/400			0.5
500		2CSG221160R1101 CT4/500	2CSG421160R1101 CT6/500	2CSG521160R1101 CT8/500	2CSG631160R1101 CT8-V/500	2CSG721160R1101 CT12/500		0.5
600		2CSG221170R1101 CT4/600	2CSG421170R1101 CT6/600	2CSG521170R1101 CT8/600	2CSG631170R1101 CT8-V/600	2CSG721170R1101 CT12/600		0.5
800			2CSG421180R1101 CT6/800	2CSG521180R1101 CT8/800	2CSG631180R1101 CT8-V/800	2CSG721180R1101 CT12/800	2CSG831180R1101 CT12-V/800	0.5
1000			2CSG421190R1101 CT6/1000	2CSG521190R1101 CT8/1000	2CSG631190R1101 CT8-V/1000	2CSG721190R1101 CT12/1000	2CSG831190R1101 CT12-V/1000	0.5
1200			2CSG421200R1101 CT6/1200	2CSG521200R1101 CT8/1200	2CSG631200R1101 CT8-V/1200	2CSG721200R1101 CT12/1200	2CSG831200R1101 CT12-V/1200	0.5
1250							2CSG831210R1101 CT12-V/1250	0.5
1500			2CSG421220R1101 CT6/1500	2CSG521220R1101 CT8/1500	2CSG631220R1101 CT8-V/1500	2CSG721220R1101 CT12/1500	2CSG831220R1101 CT12-V/1500	0.5
2000			2CSG421230R1101 CT6/2000	2CSG521230R1101 CT8/2000		2CSG721230R1101 CT12/2000	2CSG831230R1101 CT12-V/2000	0.5
2500						2CSG721240R1101 CT12/2500	2CSG831240R1101 CT12-V/2500	0.5
3000						2CSG721250R1101 CT12/3000	2CSG831250R1101 CT12-V/3000	0.5
4000							2CSG831260R1101 CT12-V/4000	0.5
5000						2CSG721270R1101 CT12/5000		
6000						2CSG721280R1101 CT12/6000		

Primary choice

		CT3	CT4	CT6	CT8	CT8-V	CT12	CT12-V	
Through primary max section [mm]		21	25	50	2x30	2x35	2x50	2x35	class
		30x10	40x10	60x20	80x30	-	125x50	-	
		20x10	40x10	-	-	3x80x5	-	4x125x5	

Standard type current transformers .../5 A with through primary

Primary rated current I _{prim}	Accuracy class	Rated power	Order details	Bbn 8012542	Price 1 piece	Price group	Weight 1 piece	Pack unit
A	VA	Type code	Order code	EAN			kg	pc.

CT3 .../5 A series, through primary

40	3	2	CT3/40	2CSG121060R1101	602408		0.340	1
50	3	2	CT3/50	2CSG121070R1101	602507		0.340	1
60	3	2	CT3/60	2CSG121080R1101	602606		0.340	1
80	3	3	CT3/80	2CSG121090R1101	602705		0.340	1
100	1	2	CT3/100	2CSG121100R1101	602804		0.340	1
150	0.5	3	CT3/150	2CSG121110R1101	602903		0.340	1
200	0.5	3	CT3/200	2CSG121120R1101	603009		0.340	1
250	0.5	5	CT3/250	2CSG121130R1101	603108		0.340	1
300	0.5	6	CT3/300	2CSG121140R1101	603207		0.340	1
400	0.5	6	CT3/400	2CSG121150R1101	603306		0.340	1
500	0.5	6	CT3/500	2CSG121160R1101	603405		0.340	1
600	0.5	6	CT3/600	2CSG121170R1101	603504		0.340	1

CT4 .../5 A series, through primary

100	1	3	CT4/100	2CSG221100R1101	603603		0.500	1
150	1	3	CT4/150	2CSG221110R1101	603702		0.500	1
200	1	4	CT4/200	2CSG221120R1101	603801		0.500	1
250	1	6	CT4/250	2CSG221130R1101	603900		0.500	1
300	0.5	6	CT4/300	2CSG221140R1101	604006		0.500	1
400	0.5	10	CT4/400	2CSG221150R1101	604105		0.500	1
500	0.5	10	CT4/500	2CSG221160R1101	604204		0.500	1
600	0.5	10	CT4/600	2CSG221170R1101	604303		0.500	1
800	0.5	10	CT4/800	2CSG221180R1101	604402		0.500	1
1000	0.5	10	CT4/1000	2CSG221190R1101	604501		0.500	1

CT3 series

Through primary	max section [mm]
cable	21
horizontal bar	30x10
vertical bar	20x10



2CSC400122F0201

CT3

CT4 series

Through primary	max section [mm]
cable	32
horizontal bar	40x10
vertical bar	40x10



2CSC400126F0201

CT4

Measurement current transformers with through primary

CT6 series

Through primary	max section [mm]
cable	50
horizontal bar	60x20
vertical bar	-

CT6

CT8 series

Through primary	max section [mm]
cable	2x30
horizontal bar	80x30
vertical bar	-

CT8

CT8-V series

Through primary	max section [mm]
cable	2x35
horizontal bar	-
vertical bar	80x30 3x80x5

CT8/V

Primary rated current I _{prim}	Accuracy class	Rated power VA	Order details	Bbn 8012542	Price 1 piece	Price group	Weight 1 piece kg	Pack unit pc.
A			Type code	Order code	EAN			

CT6 .../5 A series, through primary

250	0.5	5	CT6/250	2CSG421130R1101	605508		1.000	1
300	0.5	5	CT6/300	2CSG421140R1101	605607		1.000	1
400	0.5	6	CT6/400	2CSG421150R1101	605706		1.000	1
500	0.5	6	CT6/500	2CSG421160R1101	605805		1.000	1
600	0.5	10	CT6/600	2CSG421170R1101	605904		1.000	1
800	0.5	10	CT6/800	2CSG421180R1101	606000		1.000	1
1000	0.5	20	CT6/1000	2CSG421190R1101	606109		1.000	1
1200	0.5	20	CT6/1200	2CSG421200R1101	606208		1.000	1
1500	0.5	30	CT6/1500	2CSG421220R1101	606307		1.000	1
2000	0.5	30	CT6/2000	2CSG421230R1101	606406		1.000	1
2500	0.5	30	CT6/2500	2CSG421240R1101	606505		1.000	1

CT8 .../5 A series, through primary

300	0.5	5	CT8/300	2CSG521140R1101	606604		1.000	1
400	0.5	6	CT8/400	2CSG521150R1101	606703		1.000	1
500	0.5	10	CT8/500	2CSG521160R1101	606802		1.000	1
600	0.5	10	CT8/600	2CSG521170R1101	606901		1.000	1
800	0.5	10	CT8/800	2CSG521180R1101	607007		1.000	1
1000	0.5	10	CT8/1000	2CSG521190R1101	607106		1.000	1
1200	0.5	15	CT8/1200	2CSG521200R1101	607205		1.000	1
1500	0.5	20	CT8/1500	2CSG521220R1101	607304		1.000	1
2000	0.5	20	CT8/2000	2CSG521230R1101	607403		1.000	1
2500	0.5	20	CT8/2500	2CSG521240R1101	607502		1.000	1
3000	0.5	20	CT8/3000	2CSG521250R1101	607601		1.000	1

CT8-V .../5 A series, through primary

400	0.5	6	CT8-V/400	2CSG631150R1101	608707		0.800	1
500	0.5	10	CT8-V/500	2CSG631160R1101	608806		0.800	1
600	0.5	10	CT8-V/600	2CSG631170R1101	608905		0.800	1
800	0.5	10	CT8-V/800	2CSG631180R1101	609001		0.800	1
1000	0.5	10	CT8-V/1000	2CSG631190R1101	609100		0.800	1
1200	0.5	10	CT8-V/1200	2CSG631200R1101	609209		0.800	1
1500	0.5	10	CT8-V/1500	2CSG631220R1101	609308		0.800	1
2000	0.5	20	CT8-V/2000	2CSG631230R1101	609407		0.800	1
2500	0.5	20	CT8-V/2500	2CSG631240R1101	609506		0.800	1

Measurement current transformers with through primary

CT12 series
Through primary max section [mm]

cable	○	2x50
horizontal bar	▬	125x50
vertical bar	▮	-



CT12

2CSC400160F0201

CT12-V series
Through primary max section [mm]

cable	○	3x35
horizontal bar	▬	-
vertical bar	▮	125x30 3x100x10 4x125x5



CT12/V

2CSC400120F0202

Primary rated current I _{prim}	Accuracy class	Rated power VA	Order details	Bbn 8012542	Price 1 piece	Price group	Weight 1 piece kg	Pack unit pc.
A			Type code	Order code	EAN			

CT12 .../5 A series, through primary

500	0.5	10	CT12/500	2CSG721160R1101	607700		1.600	1
600	0.5	10	CT12/600	2CSG721170R1101	607809		1.600	1
800	0.5	15	CT12/800	2CSG721180R1101	607908		1.600	1
1000	0.5	20	CT12/1000	2CSG721190R1101	608004		1.600	1
1200	0.5	20	CT12/1200	2CSG721200R1101	608103		1.600	1
1500	0.5	20	CT12/1500	2CSG721220R1101	608202		1.600	1
2000	0.5	30	CT12/2000	2CSG721230R1101	608301		1.600	1
2500	0.5	40	CT12/2500	2CSG721240R1101	608400		1.600	1
3000	0.5	40	CT12/3000	2CSG721250R1101	608509		1.600	1
4000	0.5	50	CT12/4000	2CSG721260R1101	608608		2.000	1
5000	0.5	50	CT12/5000	2CSG721270R1101	745600		3.000	1
6000	0.5	50	CT12/6000	2CSG721280R1101	745709		3.000	1

CT12-V .../5 A series, through primary

800	0.5	10	CT12-V/800	2CSG831180R1101	609605		0.700	1
1000	0.5	10	CT12-V/1000	2CSG831190R1101	609704		0.700	1
1200	0.5	10	CT12-V/1200	2CSG831200R1101	609803		0.700	1
1250	0.5	10	CT12-V/1250	2CSG831210R1101	609902		0.700	1
1500	0.5	12	CT12-V/1500	2CSG831220R1101	610007		0.700	1
2000	0.5	15	CT12-V/2000	2CSG831230R1101	610106		1.000	1
2500	0.5	20	CT12-V/2500	2CSG831240R1101	610205		1.000	1
3000	0.5	20	CT12-V/3000	2CSG831250R1101	610304		1.000	1
4000	0.5	20	CT12-V/4000	2CSG831260R1101	745808		1.000	1



Split core measurement current transformers with through primary

Split core measurement current transformers are used in distribution panels or power centers for maintenance or system expansion. They can be installed easily and they allows to save a lot of time, avoiding bar disconnection. All transformers are complete with terminal caps and fastening accessories, both on bar and on wall.

Primary rated current I _{prim}	Accuracy class	Rated power VA	Order details	Bbn 8012542	Price 1 piece	Price group	Weight 1 piece	Pack unit
A			Type code	Order code	EAN		kg	pc.

CT30/...5 A Split core current transformers

100	3	1.5	CT30/100	2CSG101100R1101	887805		0.85	1
150	3	2	CT30/150	2CSG101110R1101	887904		0.85	1
250	0.5	1.5	CT30/250	2CSG101130R1101	888109		0.85	1
400	0.5	2.5	CT30/400	2CSG101150R1101	888000		0.85	1

Technical features

Frequency	[Hz]	50-60
Insulation voltage	[kV]	0.72
Test voltage		3 kV x 1' 50 Hz
Thermal insulation class		E
Protection grade		IP20
Permanent overload		1.2 I _n
Short circuit thermal rated current I_{th}		60 I _n
Short circuit dynamic rated current I_{din}		2.5 x I _{th}
Safety factor		<5
Case		V0 self-extinguishing thermoplastic material
Operating temperature	[°C]	-5 +50
Storage temperature	[°C]	-20 +80
Standards		IEC-EN 60044-1



2CSC400142F0202

CT80 series

Through primary max section [mm]

cable

horizontal bar

vertical bar 3x80x10



2CSC400142F0202

CT120 series

Through primary max section [mm]

cable

horizontal bar

vertical bar 4x120x10

Primary rated current I _{prim}	Accuracy class	Rated power VA	Order details	Bbn 8012542	Price 1 piece	Price group	Weight 1 piece	Pack unit
A			Type code	Order code	EAN		kg	pc.

CT80/...5 A Split core current transformers

250	0.5	1	CT80/250	2CSG201130R1101	888208		1.1	1
400	0.5	1.5	CT80/400	2CSG201150R1101	888307		1.1	1
500	0.5	2.5	CT80/500	2CSG201160R1101	888406		1.1	1
600	0.5	2.5	CT80/600	2CSG201170R1101	888505		1.1	1
800	0.5	3	CT80/800	2CSG201180R1101	888604		1.1	1
1000	0.5	5	CT80/1000	2CSG201190R1101	888703		1.1	1
2000	0.5	35	CT80/2000	2CSG301230R1101	888802		1.1	1
2500	0.5	40	CT80/2500	2CSG301240R1101	888901		1.1	1

CT120/...5 A Split core current transformers

400	0.5	1.5	CT120/400	2CSG401150R1101	889007		1.3	1
500	0.5	2.5	CT120/500	2CSG401160R1101	889106		1.3	1
600	0.5	2.5	CT120/600	2CSG401170R1101	889205		1.3	1
800	0.5	3	CT120/800	2CSG401180R1101	889304		1.3	1
1000	0.5	5	CT120/1000	2CSG401190R1101	889403		1.3	1
1200	0.5	6	CT120/1200	2CSG401200R1101	889502		1.3	1
500	0.5	8	CT120/1500	2CSG401220R1101	889601		1.3	1

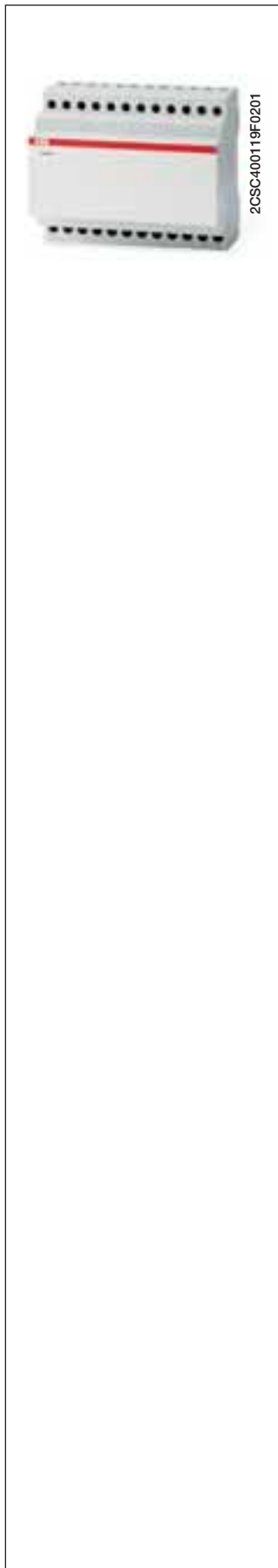

Summing current transformers

They are used for calculating the vector sum of currents of two or more lines of a single voltage system. Installation on DIN rail. The insulation reference voltage is 0.72 kV – 3 kV.

Summing current transformers return a correct measure when the input lines have the same rated capacity. The transforming ratio to be set on the instrument is equal to the sum of the lines capacity divided by 5. In case you want to measure different lines you must use a special summing current transformer.

Summing current transformers.../5 A (6 DIN modules)

No. of lines	Type	Power VA	Order details Type code	Order code	Bbn 8012542	Price 1 piece	Price group	Weight 1 piece kg	Pack unit pc.
2	5+5=5A	6	CTSM-5-5	2CSM101010R1181	610403			0.300	1
3	5+5+5=5A	6	CTSM-5-5-5	2CSM101020R1181	610502			0.300	1
4	5+5+5+5=5A	6	CTSM-5-5-5-5	2CSM101030R1181	610601			0.300	1



Voltage transformers

They are used for transforming primary voltages up to 600 V into secondary voltages of.../100 V max. for indirect supply of analogue as well as digital measurement instruments.

R3 voltage transformers are used in three-phase distribution systems with neutral.

Voltage transformers with self-extinguishing plastic housing, precision class 1

Primary/ secondary voltage	Power	Order details	Bbn 8012542	Price 1 piece	Price group	Weight 1 piece	Pack unit
V/V	VA	Type code	Order code	EAN		kg	pc.
100/100	3	TV-100/100	2CSG112010R5021	746805		1.000	1
230/100	6	TV-230/100	2CSG112070R5021	610809		1.000	1
380/100	6	TV-380/100	2CSG112090R5021	610908		1.000	1
400/100	6	TV-400/100	2CSG112110R5021	611004		1.000	1
440/100	3	TV-440/100	2CSG112130R5021	747000		1.000	1
500/100	6	TV-500/100	2CSG112150R5021	611103		1.000	1
<hr/>							
100/100-√3	1.5	TV-100R3/100	2CSG111020R5021	747604		1.000	1
230/100-√3	1.5	TV-230R3/100	2CSG111080R5021	747901		1.000	1
380/100-√3	1.5	TV-380R3/100	2CSG111100R5021	748007		1.000	1
400/100-√3	1.5	TV-400R3/100	2CSG111120R5021	748106		1.000	1
440/100-√3	1.5	TV-440R3/100	2CSG111140R5021	748205		1.000	1
500/100-√3	1.5	TV-500R3/100	2CSG111160R5021	748304		1.000	1

Voltage transformers with metallic housing, precision class 0.5

Primary/ secondary voltage	Power	Order details	Bbn 8012542	Price 1 piece	Price group	Weight 1 piece	Pack unit
V/V	VA	Type code	Order code	EAN		kg	pc.
100/100	10	TV2-100/100	2CSG324010R5021	729808		2.100	1
230/100	10	TV2-230/100	2CSG324070R5021	730101		2.100	1
380/100	10	TV2-380/100	2CSG324090R5021	730200		2.100	1
400/100	10	TV2-400/100	2CSG324110R5021	730309		2.100	1
440/100	10	TV2-440/100	2CSG324130R5021	730408		2.100	1
500/100	10	TV2-500/100	2CSG324150R5021	730507		2.100	1
600/100	10	TV2-600/100	2CSG324170R5021	730606		2.100	1
<hr/>							
100/100-√3	5	TV2-100R3/100	2CSG323020R5021	730705		2.100	1
230/100-√3	5	TV2-230R3/100	2CSG323080R5021	731009		2.100	1
380/100-√3	5	TV2-380R3/100	2CSG323100R5021	731108		2.100	1
400/100-√3	5	TV2-400R3/100	2CSG323120R5021	731207		2.100	1
440/100-√3	5	TV2-440R3/100	2CSG323140R5021	731306		2.100	1
500/100-√3	5	TV2-500R3/100	2CSG323160R5021	731405		2.100	1
600/100-√3	5	TV2-600R3/100	2CSG323180R5021	731504		2.100	1
<hr/>							
100/100	50	TV4-100/100	2CSG528010R5021	733409		2.400	1
230/100	50	TV4-230/100	2CSG528070R5021	733706		2.400	1
380/100	50	TV4-380/100	2CSG528090R5021	733805		2.400	1
400/100	50	TV4-400/100	2CSG528110R5021	733904		2.400	1
440/100	50	TV4-440/100	2CSG528130R5021	734000		2.400	1
500/100	50	TV4-500/100	2CSG528150R5021	734109		2.400	1
600/100	50	TV4-600/100	2CSG528170R5021	734208		2.400	1
<hr/>							
100/100-√3	25	TV4-100R3/100	2CSG527020R5021	734307		2.400	1
230/100-√3	25	TV4-230R3/100	2CSG527080R5021	734604		2.400	1
380/100-√3	25	TV4-380R3/100	2CSG527100R5021	734703		2.400	1
400/100-√3	25	TV4-400R3/100	2CSG527120R5021	734802		2.400	1
440/100-√3	25	TV4-440R3/100	2CSG527140R5021	734901		2.400	1
500/100-√3	25	TV4-500R3/100	2CSG527160R5021	735007		2.400	1
600/100-√3	25	TV4-600R3/100	2CSG527180R5021	735106		2.400	1

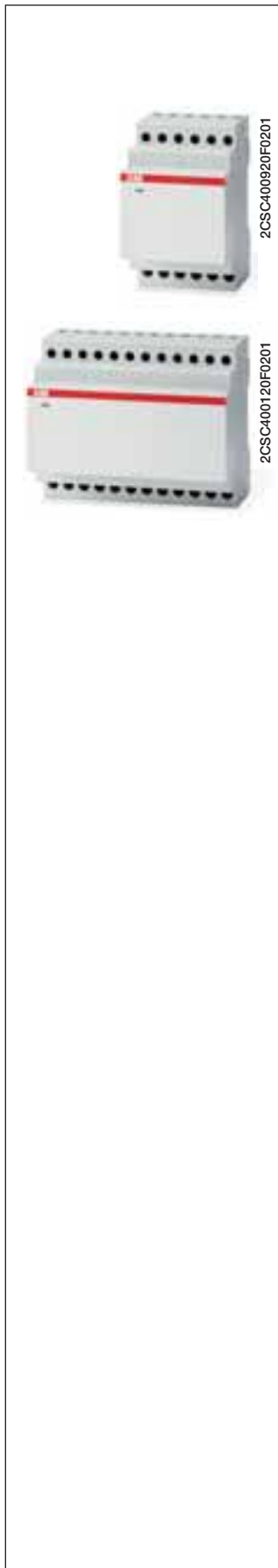

Current and voltage converters

They produce an output signal in direct current independent from the load that is directly proportional to the input current or voltage signal.

Their electronic circuit guarantees high reliability and accuracy of operation, extension of the measurement field, resistance to temperature changes and to vibrations, limited power absorption from the circuit to be measured.

Thanks to their centralized data acquisition speed, even at high distances, and thanks to the availability of different output types (that can be selected by means of the adjusting minidips) they are appropriate for plants requiring specific attention to production, distribution and use of electric energy.

Supply	Modules	Order details	Bbn	Price	Price	Weight	Pack
VAC		Type code	Order code	8012542	1 piece	1 piece	unit
				EAN		kg	pc.

Current converters with a.c. supply with inputs 1 and 5 A a.c. and selectable outputs 1-5-10 V d.c. and 1-5-10-20-4...20 mA d.c.

24	3	CONV-I-1-24CA	2CSG313000R5031	740902		0.400	1
110	3	CONV-I-1-110CA	2CSG353000R5031	741107		0.400	1
230	3	CONV-I-1-230CA	2CSG373000R5031	741206		0.400	1

Current converters with a.c. supply with inputs 60 mV d.c. and selectable outputs 1-5-10 V d.c. and 1-5-10-20-4...20 mA d.c.

24	6	CONV-I-2-24CA	2CSG414000R5031	741305		0.800	1
110	6	CONV-I-2-110CA	2CSG454000R5031	741503		0.800	1
230	6	CONV-I-2-230CA	2CSG474000R5031	741602		0.800	1

Current converters with d.c. supply with inputs 1 and 5 A a.c. and selectable outputs 1-5-10 V d.c. and 1-5-10-20-4...20 mA d.c.

24	3	CONV-I-1-24CC	2CSG323000R5031	741701		0.400	1
48	3	CONV-I-1-48CC	2CSG343000R5031	741800		0.400	1
110	3	CONV-I-1-110CC	2CSG363000R5031	741909		0.400	1

Current converters with d.c. supply with inputs 60 mV d.c. and selectable outputs 1-5-10 V d.c. and 1-5-10-20-4...20 mA d.c.

24	6	CONV-I-2-24CC	2CSG424000R5031	742005		0.800	1
48	6	CONV-I-2-48CC	2CSG444000R5031	742104		0.800	1
110	6	CONV-I-2-110CC	2CSG464000R5031	742203		0.800	1

Voltage converters with a.c. supply with inputs 120-300-500 V a.c. and selectable outputs 1-5-10 V d.c. and 1-5-10-20-4...20 mA d.c.

24	3	CONV-V-1-24CA	2CSG111000R5031	739500		0.400	1
110	3	CONV-V-1-110CA	2CSG151000R5031	739708		0.400	1
230	3	CONV-V-1-230CA	2CSG171000R5031	739807		0.400	1

Voltage converters with a.c. supply with inputs 500 V d.c. and selectable outputs 1-5-10 V d.c. and 1-5-10-20-4...20 mA d.c.

24	6	CONV-V-2-24CA	2CSG212000R5031	739906		0.800	1
110	6	CONV-V-2-110CA	2CSG252000R5031	740100		0.800	1
230	6	CONV-V-2-230CA	2CSG272000R5031	740209		0.800	1

Voltage converters with d.c. supply with inputs 120-300-500 V a.c. and selectable outputs 1-5-10 V d.c. and 1-5-10-20-4...20 mA d.c.

24	3	CONV-V-1-24CC	2CSG121000R5031	740308		0.400	1
48	3	CONV-V-1-48CC	2CSG141000R5031	740407		0.400	1
110	3	CONV-V-1-110CC	2CSG161000R5031	740506		0.400	1

Voltage converters with d.c. supply with inputs 500 V d.c. and selectable outputs 1-5-10 V d.c. and 1-5-10-20-4...20 mA d.c.

24	6	CONV-I-2-24CC	2CSG222000R5031	740605		0.800	1
48	6	CONV-I-2-48CC	2CSG242000R5031	740704		0.800	1
110	6	CONV-I-2-110CC	2CSG262000R5031	740803		0.800	1

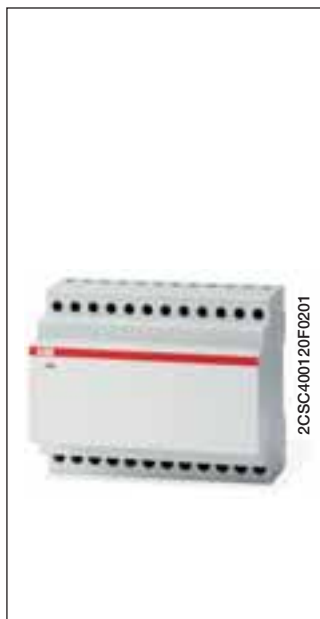

Transducers for angle phase meters

They are necessary for the indirect insertion of analogue angle phase meters. They operate with a 230 V or 400 V supply and they are equipped with an electronic programming pushbutton for the selection of the more suitable output out of the eight available outputs (1, 5, 10 V d.c. and 1, 5, 10, 20, 4/20 mA d.c.). They have a galvanic type separation between inputs and outputs.

Phase	Description	Order details	Bbn	Price	Price group	Weight	Pack unit
		Type code	Order code	1 piece		1 piece	pc.

Transducers for angle phase meters 230/440 VAC supply

1	(2 wires)	CNV-C-1	2CSM310000R1131	600206		0.400	1
3	balanced without neutral (3 wires)	CNV-C-2	2CSM320000R1131	600305		0.400	1

Technical features

Separated auxiliary supply	[V]	a.c. 230/400
Input rated values	[V]	a.c. 230/400 (5 A)
Output rated values (selectable)		1, 5, 10 V d.c. 1, 5, 10, 20, 4/20 mA d.c.
Ohmic load	[Ohm]	700
Measurement field		0÷Pn (0÷Qn)
Conversion type		proportional to phase angle or to cosφ
Accuracy rating		0.5
Permanent overload		2 In/1.2 Un
Instantaneous overload		10 In/2 Un for 1 sec.
Operating frequency	[Hz]	50/60
Time delay	[ms]	300
Alternated residue		1%
Self-consumption		voltage=1 VA/curr.=0.8 VA/aux. supply=4 VA
Input/output galvanic separation		input/output insulation, aux. supply 2 kV for 1 min./50 Hz circuit/mass insulation 4 kV for 1 min./50 Hz
Operating temperature	[°C]	0...55
Dimensions		6 DIN modules
Weight	[kg]	0.49

Shunts

Shunts have 60 mV voltage and must be used with a maximum load of 0.25 Ω in combination with measurement instruments in d.c.

For an appropriate operation:

- both horizontal and vertical mounting are possible (the horizontal position enables a greater heat consumption)
- the faying surface must be completely used and clean; cover with specific grease after the connection
- screws and bolts must be perfectly tight
- shunts must be sufficiently ventilated; as they are not insulated, it is a good rule to protect them against accidental contacts.



2CSC400523F0201

Rated current	Order details	Bbn	Price	Price	Weight	Pack
A	Type code	Order code	1 piece	group	1 piece	unit
					kg	pc.

60 mV shunts

5	SNT 1/5	2CSM100010R1121	047605		1.300	1
6	SNT 1/6	2CSM100020R1121	047704		1.800	1
10	SNT 1/10	2CSM100030R1121	047803		1.800	1
15	SNT 1/15	2CSM100040R1121	047902		1.800	1
20	SNT 1/20	2CSM100050R1121	048008		1.800	1
25	SNT 1/25	2CSM100060R1121	048107		1.800	1
30	SNT 1/30	2CSM100070R1121	048206		1.300	1
40	SNT 1/40	2CSM100080R1121	048305		1.300	1
50	SNT 1/50	2CSM100090R1121	048404		2.200	1
60	SNT 1/60	2CSM100100R1121	048503		2.200	1
80	SNT 1/80	2CSM100110R1121	048602		1.300	1
100	SNT 1/100	2CSM100120R1121	048701		1.300	1
150	SNT 1/150	2CSM100130R1121	048800		1.300	1
200	SNT 1/200	2CSM100140R1121	048909		1.300	1
250	SNT 1/250	2CSM100150R1121	049005		1.900	1
400	SNT 1/400	2CSM100160R1121	049104		1.900	1
500	SNT 1/500	2CSM100170R1121	049203		1.900	1
600	SNT 1/600	2CSM100180R1121	049302		1.900	1
800	SNT 1/800	2CSM100190R1121	049401		2.200	1
1000	SNT 1/1000	2CSM100200R1121	049500		2.000	1
1500	SNT 1/1500	2CSM100210R1121	049609		2.200	1
2000	SNT 1/2000	2CSM100220R1121	049708		2.200	1
2500	SNT 1/2500	2CSM100230R1121	049807		2.200	1
4000	SNT 1/4000	2CSM100240R1121	747109		2.200	1
6000	SNT 1/6000	2CSM100250R1121	747208		2.300	1

Technical features

Voltage	[mV]	60
Current rating	[A]	from 5 to 6000
Accuracy class		0.5 (from 10 to 30 °C)
Max. load	[Ω]	0.25
Overload for 5 sec.		from 10 to 500 A : 1xIn
		from 600 to 2000 A: 5xIn
		at 2500A: 2xIn

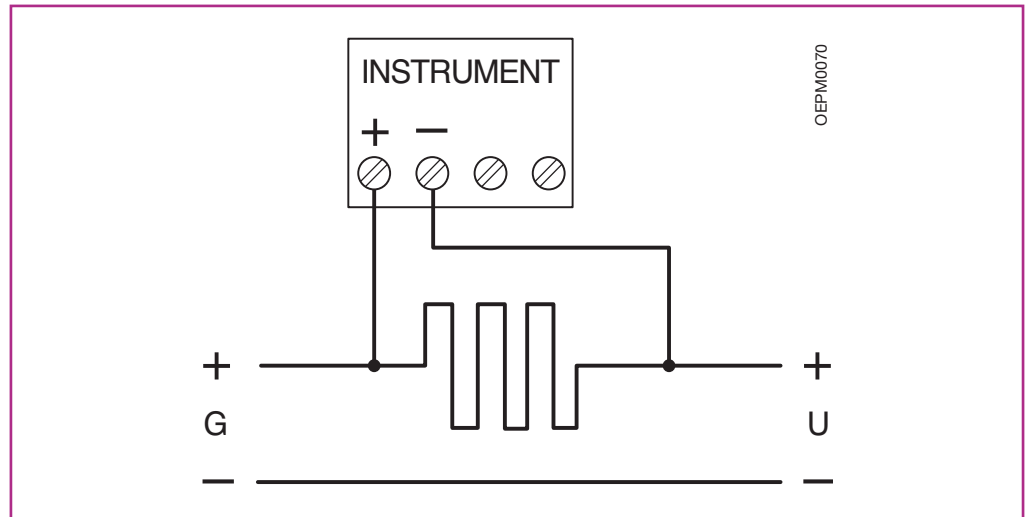

TS-C safety transformers are suitable for general and continuous use.

TM and **TS** bell transformers are suitable for driving loads that need discontinuous supply

TM-C, TM-S, TM-I are control, isolating and safety transformers.

SM, RM, TSM and **TSR** bells and buzzers are suitable for public and tertiary acoustic signalling.

Modular sockets allow the connection of devices, tools or electrical and electronic non modular equipments in civil and industrial electrical switchboards. They are available in Italian, French, German, British, Australian and Argentine standards in grey or coloured versions.

Some versions are also equipped with a fuse or a light

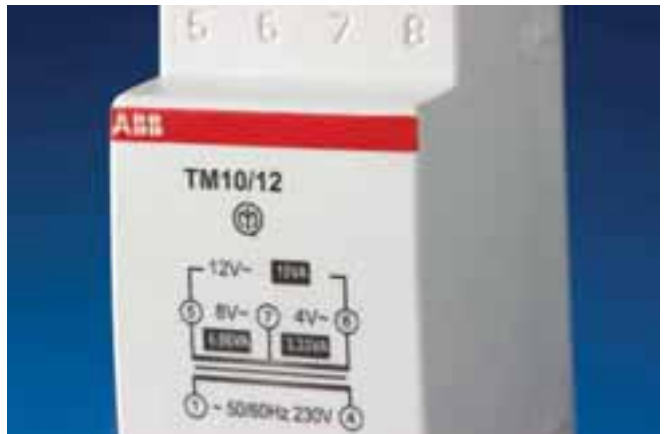





Index

Selection tables









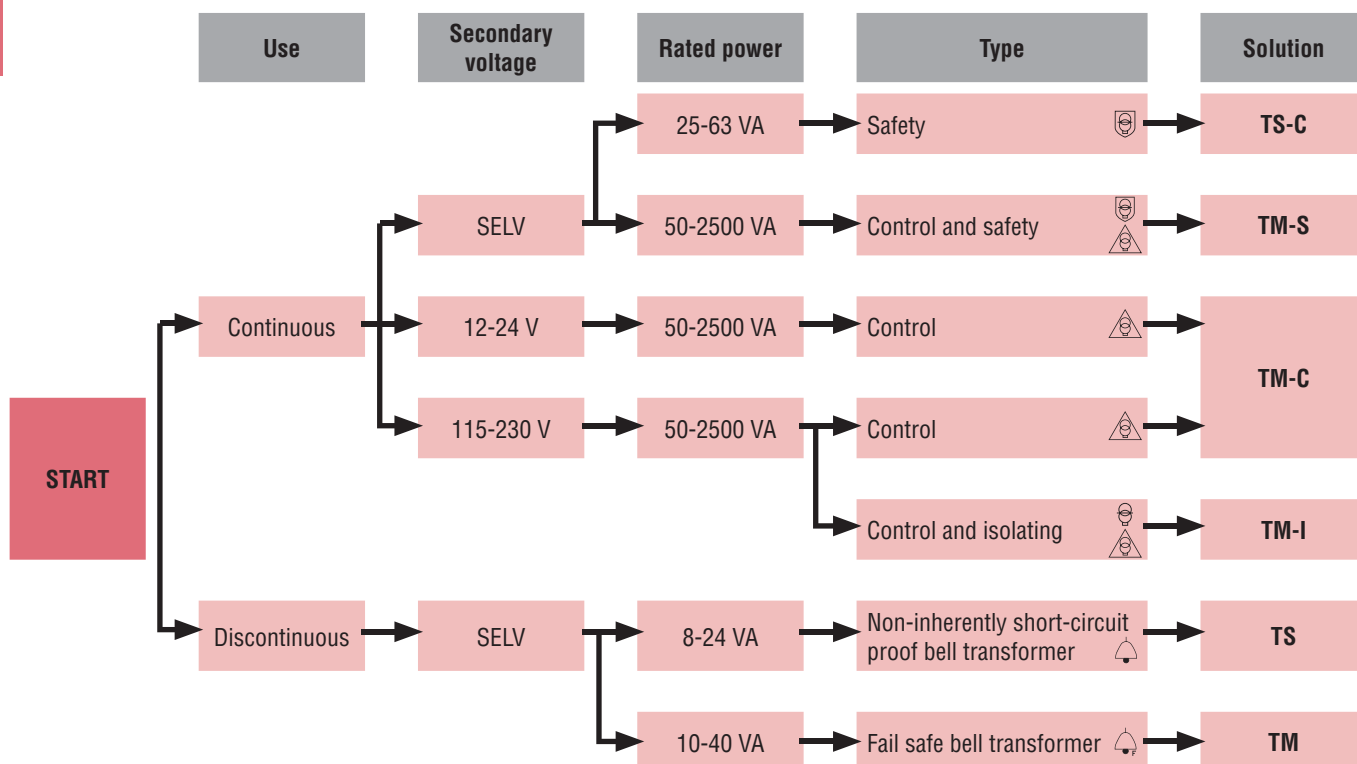



Transformer's selection table.....	9/2
TS-C safety isolating transformers for general use.....	9/4
TM fail safe bell transformers.....	9/5
TS non-inherently short-circuit proof bell transformers	9/6
TM-C, TM-S, TM-I control, isolating and safety transformers	9/8
Bells and buzzers	9/10
CP-D primary switch mode power supplies.....	9/11
Modular sockets.....	9/12
MA1-8001 DIN rail adapter.....	9/17



	Bell transformers for discontinuous use	
	TM	TS
Series	TM	TS
Reference standard	IEC EN 61558-2-8	
Classification	Fail safe 	Non-inherently short-circuit proof 
Thermal protection integrated in secondary		■
Rated power	10, 15, 30, 40 VA	8, 16, 24 VA
Operation	Discontinuous	
Primary circuit voltage ratings	230 V a.c.	230 V a.c.
Secondary circuit characteristics		
Double insulation between primary and secondary windings	■	■
Full power on all outputs		
SELV secondary (no-load output voltage <50 V a.c.)	■	■
Dimensions	2 modules [10, 15 VA] 3 modules [30, 40 VA]	2 modules [8, 16 VA] 3 modules [24 VA]
Approvals		

9

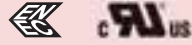

<p>Safety transformers for general use</p> 	<p>Control transformers for general use</p> 	<p>Control and Safety transformers for general use</p> 	<p>Control and Isolating transformers for general use</p> 
TS-C	TM-C	TM-S	TM-I
IEC EN 61558-2-6	CEI EN 61558-2-2	CEI EN 61558-2-2 CEI EN 61558-2-6	CEI EN 61558-2-2 CEI EN 61558-2-4
Non-inherently short-circuit proof	Non-short-circuit proof control transformer ①	Non-short-circuit-proof control and safety transformer ①	Non-short-circuit-proof control and isolating transformer ①
		 	 
■			
25, 40, 63 VA	50 to 2500 VA	50 to 2500 VA	50 to 2500 VA
Continuous	Continuous	Continuous	Continuous
230 V a.c.	230/400 V a.c.	230/400V a.c.	230/400 V a.c.
■		■	■
■	■	■	■
■		■	
4 modules [25 VA, 40 VA] 5 modules [63 VA]	See overall dimensions 13/61	See overall dimensions 13/61	See overall dimensions 13/61
			

① See page 9/7 for the choice of the protections.



Bell transformer **TM, TS**
Transformers for supplying extra low voltage, suitable for loads that require a discontinuous supply, in particular doorbells and chimes. The primary and secondary circuits are perfectly isolated and separated.
Reference standard: IEC EN 61558-2-8



Control transformer **TM-C, TM-S*, TM-I***
Transformer for supplying control circuits, for example commands, signalling, interlocks, etc.
Reference standard: CEI EN 61558-2-2



Safety transformer **TS-C, TM-S***
Isolation transformer for supplying safety extra low voltage circuits (<50 V on no load). Accidental contact with the secondary winding phases can be withstood without any danger.
Reference standard: CEI EN 61558-2-6



Isolating transformer **TM-I***
Transformer in which the primary and secondary windings are electrically separated by a double or reinforced insulation, to protect the circuit supplied by the secondary against hazards due to accidental simultaneous contact with earth and live parts, or grounded parts that may become live in the event of an insulation fault.
Reference standard: CEI EN 61558-2-4

* TM-S and TM-I both comply to two standards.



TS-C safety isolating transformers for general use

These transformers are non-inherently short-circuit proof. In fact they are equipped with a thermal protective device which automatically restores the power when the transformer is sufficiently cooled down. So even during an overload or a short-circuit they maintain their temperature below the specified limits and they continue functioning after the fault's removal.

They are ideal for supplying permanent power to meters, auxiliary electronic devices (e.g. measurement, video-entry phone systems, BUS communication) and circuits with safety extremely-low voltage (SELV) for bathrooms and showers, lighting, fountains, electro-medical devices and suchlike. One important feature of these new devices is that they take up very little space in the 4-module size for the 25 and 40 VA versions and the 5-module size for the 63 VA version.

Rated power (continuous) VA	Secondary rated voltage V	Order details	Bbn	Price 1 piece	Price group	Weight 1 piece kg	Pack unit pc.
		Type code	Order code	EAN			
25	12-24	TS 25/12-24 C	2CSM251043R0811	928508		0.920	1
40	12-24	TS 40/12-24 C	2CSM401043R0811	928607		1.100	1
63	12-24	TS 63/12-24 C	2CSM631043R0811	928706		1.150	1

Technical features

		TS 25 C	TS 40 C	TS 63 C
Primary rated voltage Un	[V]	230 a.c.	230 a.c.	230 a.c.
Secondary rated voltage Un	[V]	12 - 24 V a.c.	12 - 24 V a.c.	12 - 24 V a.c.
Rated frequency	[Hz]	50/60	50/60	50/60
Rated power (continuous use)	[VA]	25	40	63
Power loss	[W]	5	10	16,7
Modules	[No.]	4	4	5
Standards		IEC/EN 61558-2-6		
Approvals		IMQ, VDE, GOST		

Wiring diagrams and marking information

TS25/12-24 C

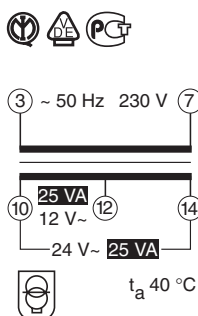

TS40/12-24 C

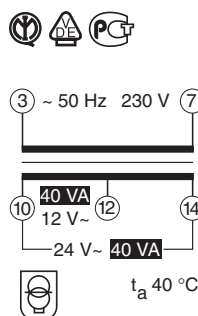

TS63/12-24 C

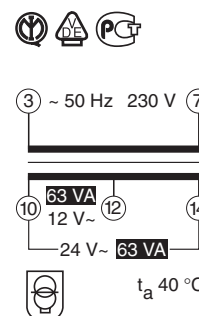

2CSC400200F0202



TM fail safe bell transformers

These transformers, with safety extremely-low voltage secondary (SELV), are suitable for loads that require a discontinuous supply, and in particular doorbells and chimes.

Fail safe operation and excellent safety are assured thanks to the perfect isolation and separation between the primary and secondary circuits.

Maximum rated power ① (discontin.)	Secondary voltage rating	Order details	Bbn	Price 1 piece	Price group	Weight 1 piece	Pack unit
VA	V a.c.	Type code	Order code	EAN		kg	pc.
10	4-8-12	TM10/12	2CSM101021R0801	367109		0.300	6
10	12-24	TM10/24	2CSM101041R0801	367208		0.300	6
15	4-8-12	TM15/12	2CSM151021R0801	367307		0.300	6
15	12-24	TM15/24	2CSM151041R0801	367406		0.300	6
30	4-8-12	TM30/12	2CSM301021R0801	367505		0.450	4
30	12-24	TM30/24	2CSM301041R0801	367604		0.450	4
40	4-8-12	TM40/12	2CSM401021R0801	367703		0.450	4
40	12-24	TM40/24	2CSM401041R0801	367802		0.450	4

① See diagrams below for the RMS power on each secondary output

Technical characteristics

Rated primary voltage Un	[V]	230 a.c.
Rated secondary voltage Un	[V]	4, 8, 12, 24
Rated frequency	[Hz]	50/60
Rated power (discontinuous)	[VA]	10, 15, 30, 40
Power loss	[W]	1...4
Modules	[No.]	2 (TM10, TM15), 3(TM30, TM40)
Cable section (Ø min/max)	[mm²]	1.5 / 10
Tightening torque	[Nm]	1
Protection degree		IP 20
Reference standards		IEC/EN 61558-2-8
Approvals		GOST, IMQ (TM10, TM15, TM30)

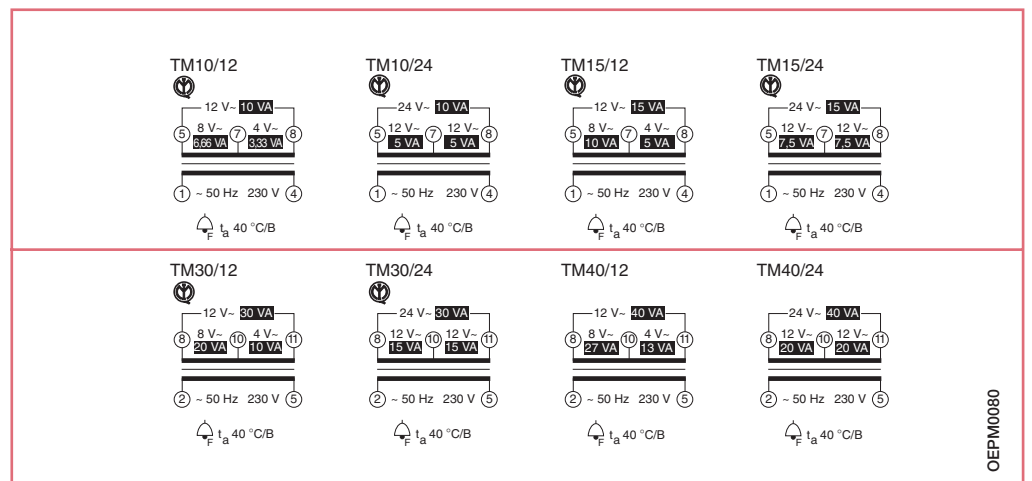



TS non-inherently short-circuit proof bell transformers

These transformers, with safety extremely-low voltage secondary (SELV), are suitable for driving loads that call for a discontinuous supply, and in particular doorbells and chimes. In addition to perfect isolation and separation between the primary and secondary circuits, the TS transformers have a thermal protection device integrated into the secondary that makes them resistant to short circuit currents (non-inherently short-circuit proof).

In addition, the TS8/SW series is equipped with a switch for controlling loads connected to the secondary.

Maximum rated power (1) (discontin.)	Secondary voltage rating	Switch 0-1	Order details	Bbn 8012542	Price 1 piece	Price group	Weight 1 piece	Pack unit
VA	V a.c.		Type code	Order code	EAN		kg	pc.
8	8		TS8/8	2CSM081301R0811	368007		0.355	6
8	12		TS8/12	2CSM081401R0811	368106		0.355	6
8	24		TS8/24	2CSM081501R0811	368205		0.355	6
8	8	■	TS8/8 SW	2CSM081302R0811	368304		0.277	6
8	12	■	TS8/12 SW	2CSM081402R0811	368403		0.277	6
8	4-6-8	■	TS8/4-6-8 SW	2CSM081012R0811	368601		0.280	6
8	4-8-12	■	TS8/4-8-12 SW	2CSM081022R0811	368700		0.280	6
16	8		TS16/8	2CSM161301R0811	368809		0.355	6
16	12		TS16/12	2CSM161401R0811	368908		0.355	6
16	24		TS16/24	2CSM161501R0811	369004		0.330	6
16	4-6-8		TS16/4-6-8	2CSM161011R0811	369103		0.333	6
16	4-8-12		TS16/4-8-12	2CSM161021R0811	369202		0.333	6
24	4-8-12		TS24/4-8-12	2CSM241021R0811	369301		0.465	4
24	8-12-24		TS24/8-12-24	2CSM241031R0811	369400		0.465	4

(1) See diagrams below for the RMS power on each secondary output

Technical characteristics

Rated voltage Un primary	[V]	230 a.c.
Rated voltage Un secondary	[V]	4, 8, 12, 24
Rated frequency	[Hz]	50/60
Rated power (discontinuous)	[VA]	10, 15, 30, 40
Power loss	[W]	1...4
Modules	[No.]	2 (TS8,TS16), 3(TS24)
Cable section (Ø min/max)	[mm²]	1.5 / 10
Tightening torque	[Nm]	1
Protection degree		IP 20
Reference standards		IEC/EN 61558-2-8
Approvals		VDE, GOST

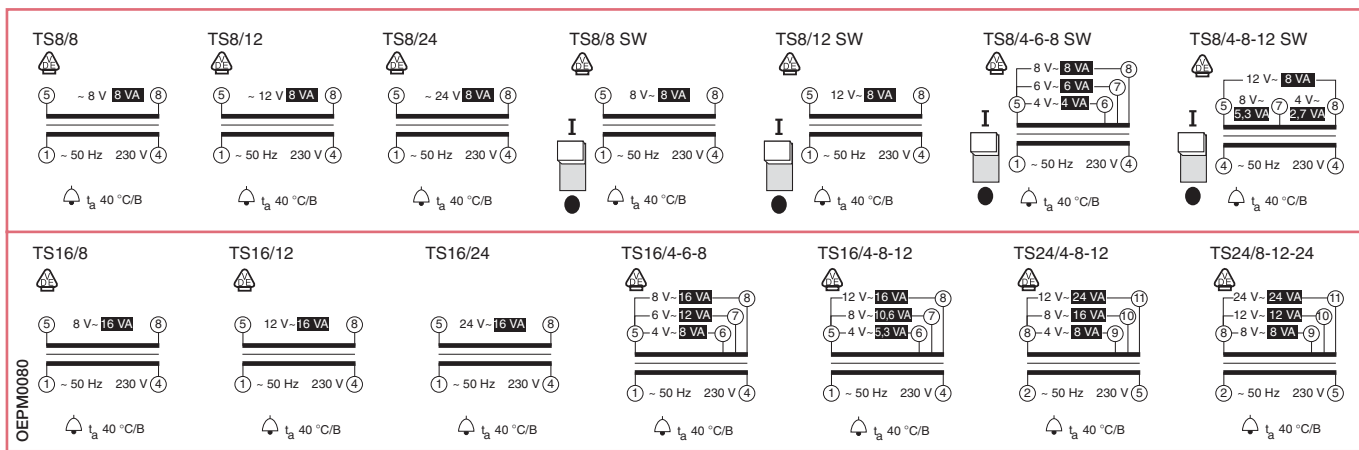

Overall dimensions..... pag. 13/59

Selection table of products and secondary protections
Primary protection: see page 11/165



Power VA	Secondary voltage	TM-C Control				TM-S Control/Safety				TM-I Control/Isolating	
		12 V	24 V	115 V	230 V	12 V	24 V	24 V	48 V	115 V	230 V
50	Transformer	2CSM207113R0801		2CSM207213R0801		2CSM236893R0801		2CSM204653R0801 ②		2CSM204583R0801	
	Fuse gauge ①	4 A	2 A	0.4 A	0.2 A	4 A	2 A	2 A	1 A	0.4 A	0.2 A
100	Transformer	2CSM207103R0801		2CSM236933R0801		2CSM207163R0801		2CSM204643R0801		2CSM201123R0801	
	Fuse gauge ①	8 A	4 A	0.8 A	0.4 A	8 A	4 A	4 A	2 A	0.8 A	0.4 A
	Breaker type	S202 C8	S202 C4	S202 C1	S202 C0,5	S202 C8	S202 C4	S202 C4	S202 C2	S202 C1	S202 C0,5
160	Transformer	2CSM236853R0801		2CSM207203R0801		2CSM202073R0801		2CSM204633R0801		2CSM204533R0801	
	Fuse gauge ①	12 A	6.3 A	1.25 A	0.63 A	12 A	6,3 A	6.3 A	3.15 A	1.25 A	0.63 A
	Breaker type	S202 C13	S202 C8	S202 C1.6	S202 C-	S202 C13	S202 C8	S202 C8	S202 C4	S202 C1.6	-
200	Transformer	2CSM236823R0801		2CSM236883R0801		2CSM260043R0801				2CSM204513R0801	
	Fuse gauge ①	16 A	8 A	1.6 A	0.8 A	16 A	8 A			1.6 A	0.8 A
	Breaker type	S202 C16	S202 C8	S202 C2	S202 C1	S202 C16	S202 C8			S202 C2	S202 C1
250	Transformer	2CSM207093R0801		2CSM236923R0801		2CSM260063R0801		2CSM204673R0801		2CSM204493R0801	
	Fuse gauge ①	20 A	10 A	2 A	1 A	20 A	10 A	10 A	5 A	2 A	1 A
	Breaker type	S202 C20	S202 C10	S202 C2	S202 C1	S202 C20	S202 C10	S202 C10	S202 C6	S202 C2	S202 C1
320	Transformer	2CSM236843R0801		2CSM236923R0801		2CSM260063R0801		2CSM204673R0801		2CSM204493R0801	
	Fuse gauge ①	25 A	12 A	2.5 A	1.25 A	25 A	12 A	12 A	6.3 A	2.5 A	1.25 A
	Breaker type	S202 C25	S202 C13	S202 C3	S202 C1,6	S202 C25	S202 C13	S202 C13	S202 C8	S202 C3	S202 C1,6
400	Transformer	2CSM289703R0801		2CSM207193R0801		2CSM260103R0801		2CSM204613R0801		2CSM201073R0801	
	Fuse gauge ①	32 A	16 A	3.15 A	1.6 A	32 A	16 A	16 A	8 A	3.15 A	1.6 A
	Breaker type	S202 C32	S202 C16	S202 C4	S202 C2	S202 C32	S202 C16	S202 C16	S202 C8	S202 C4	S202 C2
630	Transformer	2CSM236813R0801		2CSM207183R0801		2CSM260053R0801		2CSM204603R0801		2CSM204423R0801	
	Fuse gauge ①	50 A	25 A	5 A	2.5 A	50 A	25 A	25 A	12 A	5 A	2.5 A
	Breaker type	S202 C50	S202 C25	S202 C6	S202 C3	S202 C50	S202 C25	S202 C25	S202 C13	S202 C6	S202 C3
1000	Transformer	2CSM292873R0801		2CSM236913R0801		2CSM260093R0801				2CSM204413R0801	
	Fuse gauge ①	80 A	40 A	8 A	4 A	80 A	40 A			8 A	4 A
	Breaker type	S292 C80	S202 C40	S202 C8	S202 C4	S292 C80	S202 C40			S202 C8	S202 C4
1600	Transformer	2CSM292863R0801		2CSM201813R0801		2CSM260083R0801				2CSM204403R0801	
	Fuse gauge ①	125 A	63 A	16 A	8 A	125 A	63 A			16 A	8 A
	Breaker type	S292 C125	S202 C63	S202 C16	S202 C8	S292 C125	S202 C63			S202 C16	S202 C8
2000	Transformer	2CSM292853R0801		2CSM236903R0801		2CSM260073R0801				2CSM204383R0801	
	Fuse gauge ①	160 A	80 A	16 A	8 A	160 A	80 A			16 A	8 A
	Breaker type	-	S292 C80	S202 C20	S202 C10	-	S292 C80			S202 C20	S202 C10
2500	Transformer	2CSM236943R0801		2CSM207173R0801		2CSM204663R0801				2CSM204363R0801	
	Fuse gauge ①	200 A	100 A	20 A	10 A	200 A	100 A			20 A	10 A
	Breaker type	-	S292 C100	S202 C25	S202 C13	-	S292 C100			S202 C25	S202 C13

① FUSES
- Gauge ≤ 6.3 A use aM fuses with high breaking capacity and IEC60127-compliant
- Gauge > 6.3 A use gG fuses IEC60269-2 or IEC60269-3-compliant

② TM-S 50/24-48 P complies with IEC EN 61558-2-4 on the secondary circuit at 48 V and with IEC EN 61558-2-6 on the secondary circuit at 24 V



Rated power	Secondary voltages	Order details	Bbn	Price	Price	Weight	Pack
VA	V a.c.	Type code	Order code	EAN	1 piece	1 piece	unit
						kg	pc.
TM-C single phase control transformers, primary 230-400 V							
50	12-24	TM-C 50/12-24	2CSM207113R0801	071136		1.1	1
100	12-24	TM-C 100/12-24	2CSM207103R0801	071037		2	1
160	12-24	TM-C 160/12-24	2CSM236853R0801	368533		3	1
200	12-24	TM-C 200/12-24	2CSM236823R0801	368236		3.2	1
250	12-24	TM-C 250/12-24	2CSM207093R0801	070931		3.6	1
320	12-24	TM-C 320/12-24	2CSM236843R0801	368434		4.4	1
400	12-24	TM-C 400/12-24	2CSM289703R0801	897033		5.5	1
630	12-24	TM-C 630/12-24	2CSM236813R0801	368137		7.8	1
1000	12-24	TM-C 1000/12-24	2CSM292873R0801	928737		13.2	1
1600	12-24	TM-C 1600/12-24	2CSM292863R0801	928638		21.2	1
2000	12-24	TM-C 2000/12-24	2CSM292853R0801	928539		25.5	1
2500	12-24	TM-C 2500/12-24	2CSM236943R0801	369431		26.8	1
50	115-230	TM-C 50/115-230	2CSM207213R0801	072133		1.1	1
100	115-230	TM-C 100/115-230	2CSM236933R0801	369332		2	1
160	115-230	TM-C 160/115-230	2CSM207203R0801	072034		3	1
200	115-230	TM-C 200/115-230	2CSM236883R0801	368830		3.2	1
250	115-230	TM-C 250/115-230	2CSM207153R0801	071532		3.6	1
320	115-230	TM-C 320/115-230	2CSM236923R0801	369233		4.4	1
400	115-230	TM-C 400/115-230	2CSM207193R0801	071938		5.5	1
630	115-230	TM-C 630/115-230	2CSM207183R0801	071839		7.8	1
1000	115-230	TM-C 1000/115-230	2CSM236913R0801	369134		13.2	1
1600	115-230	TM-C 1600/115-230	2CSM201813R0801	018131		21.2	1
2000	115-230	TM-C 2000/115-230	2CSM236903R0801	369035		25.5	1
2500	115-230	TM-C 2500/115-230	2CSM207173R0801	071730		26.8	1

Technical characteristics

	TM-C	TM-S	TM-I
Rated primary voltage Un [V]	230/400 a.c.	230/400 a.c.	230/400 a.c.
Primary voltage adjustment outlets ±15 V	No	Yes	Yes
Max ambient temperature ③ [°C]	40	40	40
Rated secondary voltage Un [V]	12-24, 115-230 a.c.	12-24, 24-48 a.c. ②	115-230 a.c.
Rated frequency [Hz]	50/60	50/60	50/60
Isolation voltage between primary and secondary [kV]	3.5	4.8	4.8
Rated powers [VA]	50-2500	50-2500	50-2500
Primary cable section (Ø max) [mm²]	6	6	6
Operating temperature [°C]	①	①	①
Approvals	ENEC (Up to 1000 VA), UR, CSA	ENEC (Up to 1000 VA), UR, CSA	ENEC (Up to 1000 VA), UR, CSA
Standards	CEI EN 61558-2-2	CEI EN 61558-2-2 CEI EN 61558-2-6	CEI EN 61558-2-2 CEI EN 61558-2-4

① See technical details

② TM-S 50/24-48 P complies to CEI EN 61558-2-4 on the 48 V secondary and to CEI EN 61558-2-6 on the 24 V secondary

③ Maximum temperature without any power draw. See technical details for power draw according to temperature.

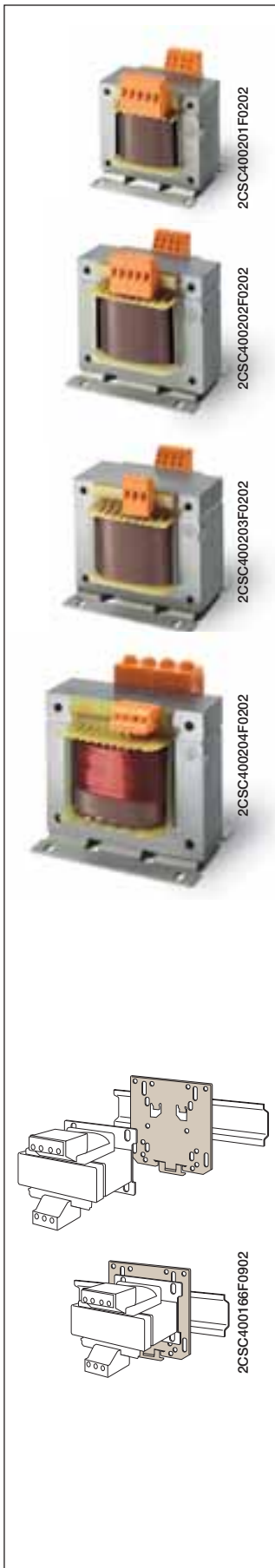

Rated power	Secondary voltages	Order details	Bbn 8012542	Price 1 piece	Price group	Weight 1 piece	Pack unit
VA	V a.c.	Type code	Order code	EAN		kg	pc.

TM-S single phase control and safety transformers, primary 230-400 V ±15

50	12-24	TM-S 50/12-24 P	2CSM236893R0801	368939		1.1	1
100	12-24	TM-S 100/12-24 P	2CSM207163R0801	071631		2	1
160	12-24	TM-S 160/12-24 P	2CSM202073R0801	020738		3	1
200	12-24	TM-S 200/12-24 P	2CSM260043R0801	600435		3.2	1
250	12-24	TM-S 250/12-24 P	2CSM260113R0801	601135		3.6	1
320	12-24	TM-S 320/12-24 P	2CSM260063R0801	600633		4.4	1
400	12-24	TM-S 400/12-24 P	2CSM260103R0801	601036		5.5	1
630	12-24	TM-S 630/12-24 P	2CSM260053R0801	600534		7.8	1
1000	12-24	TM-S 1000/12-24 P	2CSM260093R0801	600930		13.2	1
1600	12-24	TM-S 1600/12-24 P	2CSM260083R0801	600831		21.2	1
2000	12-24	TM-S 2000/12-24 P	2CSM260073R0801	600732		25.5	1
2500	12-24	TM-S 2500/12-24 P	2CSM204663R0801	046639		26.8	1

50	24-48	TM-S 50/24-48 P	2CSM204653R0801	046530		1.1	1
100	24-48	TM-S 100/24-48 P	2CSM204643R0801	046431		2	1
160	24-48	TM-S 160/24-48 P	2CSM204633R0801	046332		3	1
250	24-48	TM-S 250/24-48 P	2CSM204683R0801	046837		3.2	1
320	24-48	TM-S 320/24-48 P	2CSM204673R0801	046738		3.6	1
400	24-48	TM-S 400/24-48 P	2CSM204613R0801	046134		4.4	1
630	24-48	TM-S 630/24-48 P	2CSM204603R0801	046035		5.5	1

TM-I single phase control and isolating transformers, primary 230-400 V ±15

50	115-230	TM-I 50/115-230 P	2CSM204583R0801	045830		1.1	1
100	115-230	TM-I 100/115-230 P	2CSM201123R0801	011231		2	1
160	115-230	TM-I 160/115-230 P	2CSM204533R0801	045335		3	1
200	115-230	TM-I 200/115-230 P	2CSM204513R0801	045137		3.2	1
250	115-230	TM-I 250/115-230 P	2CSM204503R0801	045038		3.6	1
320	115-230	TM-I 320/115-230 P	2CSM204493R0801	044932		4.4	1
400	115-230	TM-I 400/115-230 P	2CSM201073R0801	010739		5.5	1
630	115-230	TM-I 630/115-230 P	2CSM204423R0801	044239		7.8	1
1000	115-230	TM-I 1000/115-230 P	2CSM204413R0801	044130		13.2	1
1600	115-230	TM-I 1600/115-230 P	2CSM204403R0801	044031		21.2	1
2000	115-230	TM-I 2000/115-230 P	2CSM204383R0801	043836		25.5	1
2500	115-230	TM-I 2500/115-230 P	2CSM204363R0801	043638		26.8	1

Accessories

Order details	Bbn 8012542	Price 1 piece	Price group	Weight 1 piece	Pack unit
Type code	Order code	EAN		kg	pc.
Mounting bracket for DIN rail (up to 160 VA)	TM-C-DIN	2CSM201033R0801	010333	0.10	10

TM-C

Label on product:
12-24 V output

115-230 V output

TM-S, TM-I

Label on product:
12-24 V output TM-S

24-48 V output TM-S

115-230 V output TM-I



Bells and buzzers

The range of bells and buzzers includes modular versions for discontinuous use SM1, RM1, TSM and TSR, suitable for acoustic signalling in residential and commercial sectors, and versions for continuous use SM2 and RM2, which are able to operate continuously for up to 12 hours while maintaining the quality and level of the sound. RM2 and SM2 are dedicated to specific applications such as acoustic signalling in the industry, alarms notification, supervision and intensive use (schools, factories etc...). TSM and TSR versions also include a transformer: the input is 230V a.c. and the bell is supplied in 12 or 24 V.

Rated voltage	Use	Order details	Bbn	Price	Price group	Weight	Pack
V AC		Type code	Order code	8012542	1 piece	1 piece	unit
			EAN			kg	pc.

SM electro-mechanical modular bells

8/12	Discontinuous	SM1-12	2CSM111000R0821	886204		0.076	12
230	Discontinuous	SM1-230	2CSM131000R0821	886303		0.076	12
12	Continuous	SM2-12	2CSM112000R0821	886600		0.076	12
24	Continuous	SM2-24	2CSM122000R0821	886709		0.076	12
230	Continuous	SM2-230	2CSM132000R0821	886808		0.076	12

RM electro-mechanical modular buzzers

8/12	Discontinuous	RM1-12	2CSM211000R0821	886419		0.076	12
230	Discontinuous	RM1-230	2CSM231000R0821	886518		0.076	12
12	Continuous	RM2-12	2CSM212000R0821	886907		0.076	12
24	Continuous	RM2-24	2CSM222000R0821	887003		0.076	12
230	Continuous	RM2-230	2CSM232000R0821	887102		0.076	12

TSM modular electronic bell (two-tones) + transformer included

230	Discontinuous	TSM	2CSM100000R0841	007005		0.300	6
-----	---------------	------------	-----------------	---------------	--	-------	---

TSR bell + buzzer + transformer included

230	Discontinuous	TSR	2CSM100000R0831	369608		0.300	1
-----	---------------	------------	-----------------	---------------	--	-------	---

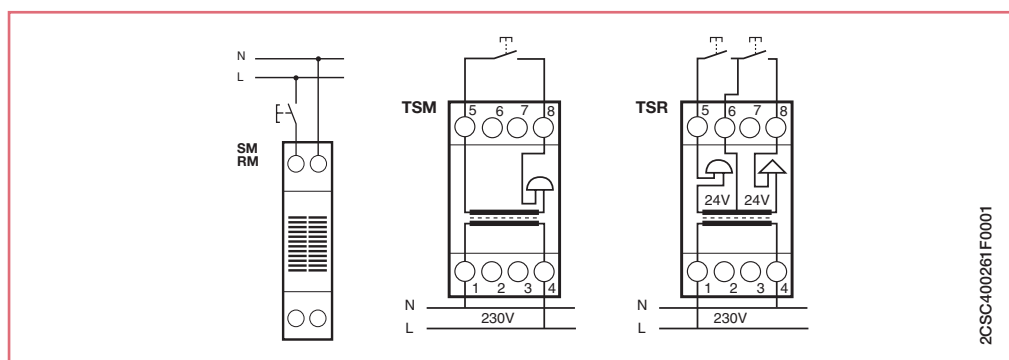

Technical characteristics

		SM1-12, RM1-12	SM1-230, RM1-230	SM2-12, RM2-12	SM2-24, RM2-24	SM2-230, RM2-230	TSM, TSR
Rated Voltage Un	[V c.a.]	8-12	230	12	24	230	230
Rated frequency	[Hz]	50	50	50	50	50	50
Power consumption	[VA]	2,5-6,5	4,5	4,5	4,5	4,5	5,5
Sound level at 1 meter	SM: [dB]	82	82	82	82	82	80
	RM: [dB]	80	80	80	80	80	70
Max permanent working time		15 min	15 min	12 h ①	12 h ①	12 h ①	TSM: 1 min TSR: 5 min
Max cable cross-section	[mm²]	10	10	10	10	10	10
Mounting position		vertical only					
Protection degree		IP20-IP40, switchboard mounting					
Modules	[No.]	1	1	1	1	1	2

① Continuative work for more than 12 hours could affect the sound level

Overall dimensions..... pag. 13/59



**CP-D 12/0.83,
CP-D 24/0.42**

**CP-D 12/2.1
CP-D 24/1.3**

CP-D 24/2.5

CP-D 24/4.2





Primary switch mode power supplies

Type	Rated input voltage	Rated output voltage / current	Order code	Pack. unit pieces	Price 1 piece	Weight 1 piece kg/lb
CP-D 12/0.83	100-240 V AC	12 V DC / 0.83 A	1SVR 427 041 R1000	1		0.06/0.13
CP-D 12/2.1	100-240 V AC	12 V DC / 2.1 A	1SVR 427 043 R1200	1		0.19/0.41
CP-D 24/0.42	100-240 V AC	24 V DC / 0.42 A	1SVR 427 041 R0000	1		0.06/0.13
CP-D 24/1.3	100-240 V AC	24 V DC / 1.3 A	1SVR 427 043 R0100	1		0.19/0.41
CP-D 24/2.5	100-240 V AC	24 V DC / 2.5 A	1SVR 427 044 R0200	1		0.25/0.55
CP-D 24/4.2	100-240 V AC	24 V DC / 4.2 A	1SVR 427 045 R0400	1		0.32/0.71

- Output voltages 12 V, 24 V
- Adjustable output voltages (devices > 10 W)
- Output currents 0.42 A / 0.83 A / 1.3 A / 2.1 A / 2.5 A / 4.2 A
- Power range 10 W, 30 W, 60 W, 100 W
- Wide range input 100-240 V AC (90-264 V AC, 120-370 V DC)
- High efficiency of up to 89 %
- Low power dissipation and low heating
- Free convection cooling (no forced cooling with ventilators)
- Ambient temperature range during operation -10...+70 °C
- Open-circuit, overload and short-circuit stable
- Integrated input fuse
- U/I characteristic (fold-forward behaviour at overload – no switch-off)
- LEDs for status indication
- Light-grey enclosure in RAL 7035

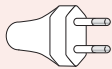
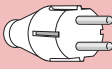
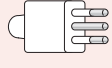
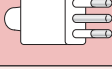
Series selection

For further information about sockets selection by country please see page 11/176

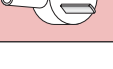
	M1175	M1173	M1170	M1174	M1363	M1176	M2071
 EU 10A	■	■	■	■			
 Schuko 10 A / 16 A	■	■	■				
 Italian 10 A		■	■				
 Italian 16 A			■				
 French 10 A / 16 A	Pluggable but not earthed	Pluggable but not earthed	Pluggable but not earthed	■			
 British 13 A					■		
 Australian 10 A / 15 A						■	
 Argentine 10 A							■



Model selection

	RAL 7035	RAL 6029	RAL 3000	RAL 7012
--	----------	----------	----------	----------

German Schuko Standard

 M1175	2CSM210000R0721	2CSM220000R0721	2CSM230000R0721	2CSM240000R0721
 M1175-L  Indicator light	2CSM212000R0721	2CSM222000R0721	2CSM232000R0721	2CSM242000R0721
 M1175-FL  Indicator light  Fuse 6.3 A aM	2CSM214000R0721	2CSM224000R0721	2CSM234000R0721	2CSM244000R0721
 M1175-C  Cover IP30	2CSM211000R0721	2CSM221000R0721	2CSM231000R0721	2CSM241000R0721

Italian P30 standard

 M1173	2CSM110000R0701	2CSM120000R0701	2CSM130000R0701	2CSM140000R0701
 M1173-L  Indicator light	2CSM112000R0701	2CSM122000R0701	2CSM132000R0701	2CSM142000R0701

RAL 7035

RAL 6029

RAL 3000

RAL 7012



Italian dual standard 

	M1170	2CSM210000R0701	2CSM220000R0701	2CSM230000R0701	2CSM240000R0701
---	-------	-----------------	-----------------	-----------------	-----------------

French Standard   

	M1174	2CSM110000R0711			
---	-------	-----------------	--	--	--

British Standard  Available in the second half of 2011

	M1363	2CSM259343R0721			
	M1363-L	 Indicator light	2CSM258163R0721		

Australian Standard  Available in the second half of 2011

	M1176-L10	10 A	 Indicator light	2CSM256983R0721		
	M1176-L15	15 A	 Indicator light	2CSM259473R0721		

Argentine Standard  Available in the second half of 2011

	M2071-L10	10 A	 Indicator light	2CSM257783R0721		
---	-----------	------	---	-----------------	--	--

Modular sockets

Modular sockets allow the connection of devices, tools or electrical and electronic non modular equipments in civil and industrial electrical switchboards.

The range is composed by standard versions as well as upgraded versions with additional features as light indicator, protection fuse, cover and coloration.

In addition to the grey-coloured (RAL 7035) version there are three other colours which are useful to indicate specific socket uses:

- green (RAL 6029), for example to indicate a dedicated upstream protection device;
- red (RAL 3000), for example to indicate an UPS group that allows the socket to be used if the main power supply fails;
- black (RAL 7012), to match with industrial and automation devices.

Color	Description	Bbn	Weight	Pack unit
Type	Order code	8012542 EAN	1 piece kg	

German Shuko standard modular sockets

The M1175 series (VDE certified) takes Schuko standard plugs up to 16 A. Also available with cover, M1175-C.

grey	M1175	2CSM210000R0721	027850	0,120	4
green	M1175-G	2CSM220000R0721	027959	0,120	4
red	M1175-R	2CSM230000R0721	028055	0,120	4
black	M1175-B	2CSM240000R0721	028154	0,120	4
grey with cover	M1175-C	2CSM211000R0721	029052	0,140	4
green with cover	M1175-C-G	2CSM221000R0721	029151	0,140	4
red with cover	M1175-C-R	2CSM231000R0721	029250	0,140	4
black with cover	M1175-C-B	2CSM241000R0721	029359	0,140	4

German Shuko standard modular sockets with integrated indicator light and fuse

grey with light	M1175-L	2CSM212000R0721	028253	0,140	4
green with light	M1175-L-G	2CSM222000R0721	028352	0,140	4
red with light	M1175-L-R	2CSM232000R0721	028451	0,140	4
black with light	M1175-L-B	2CSM242000R0721	028550	0,140	4
grey with light and fuse	M1175-FL	2CSM214000R0721	028659	0,160	4
green with light and fuse	M1175-FL-G	2CSM224000R0721	028758	0,160	4
red with light and fuse	M1175-FL-R	2CSM234000R0721	028857	0,160	4
black with light and fuse	M1175-FL-B	2CSM244000R0721	028956	0,160	4

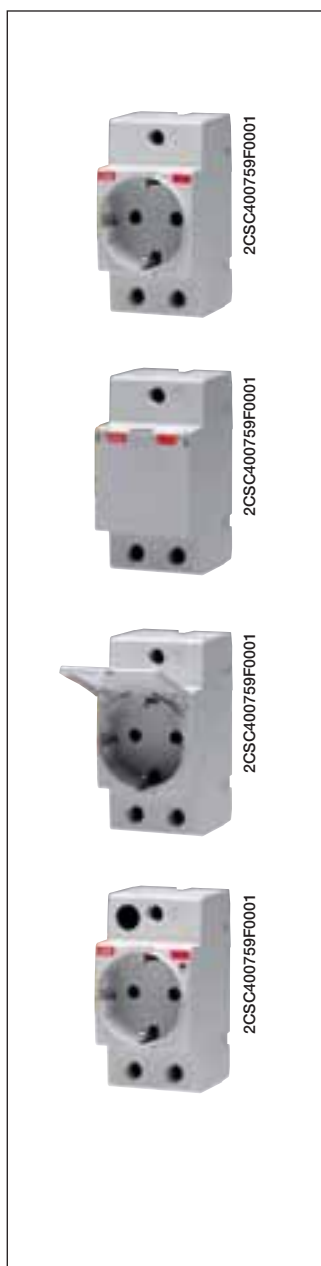

Fuse detail



Indicator light detail





Italian P30 standard modular sockets

The M1173 series (IMQ certified) takes Italian standard 10 A plugs and Schuko plugs up to 16 A

grey	M1173	2CSM110000R0701	004103	0,120	4
green	M1173-G	2CSM120000R0701	026754	0,120	4
red	M1173-R	2CSM130000R0701	026853	0,120	4
black	M1173-B	2CSM140000R0701	026952	0,120	4

Italian P30 standard modular sockets with integrated indicator light

grey with light	M1173-L	2CSM112000R0701	027058	0,140	4
green with light	M1173-L-G	2CSM122000R0701	027157	0,140	4
red with light	M1173-L-R	2CSM132000R0701	027256	0,140	4
black with light	M1173-L-B	2CSM142000R0701	027355	0,140	4

Italian dual standard modular sockets

The M1170 series takes Italian standard P11/P17 plugs and Schuko plugs up to 16 A

grey	M1170	2CSM210000R0701	027454	0,120	4
green	M1170-G	2CSM220000R0701	027553	0,120	4
red	M1170-R	2CSM230000R0701	027652	0,120	4
black	M1170-B	2CSM240000R0701	027751	0,120	4

French standard modular sockets

The M1174 series (LCIE and CEPEC certified) takes French standard plugs up to 16 A

grey	M1174	2CSM110000R0711	006602	0,140	4
------	--------------	-----------------	---------------	-------	---

British standard modular sockets. Available in the second half of 2011.

The M1163 series takes British standard BS1363 plugs up to 13 A

grey	M1363	2CSM259343R0721	593430	0,140	4
grey with light	M1363-L	2CSM258163R0721	581635	0,140	4

Australian/New Zealand standard modular sockets. Available in the second half of 2011.

The M1176 series takes Australian/New Zealand standard AS/NZS 3112 plugs up to 10 A and 15 A

grey with light	10A	M1176-L10	2CSM256983R0721	569831	0,110	4
grey with light	15A	M1176-L15	2CSM259473R0721	594734	0,110	4

Argentine standard modular sockets. Available in the second half of 2011.

The M2071 series takes Argentine standard IRAM 2071 plugs up to 10 A

grey with light	10A	M2071-L10	2CSM257783R0721	577836	0,110	4
-----------------	-----	------------------	-----------------	---------------	-------	---

Technical specifications

Rated voltage Un	[V]	250 a.c.						
Rated current In	[A]	16 (M1170, M1173, M1174, M1175), 13 (M1363), 10 (M1176-L10, M2071-L10), 15 (M1176-L15)						
Rated frequency	[Hz]	50/60						
Power loss	[W]	0,6						
Modules	[No.]	2,5, 3 for M1363						
Safety shutters		yes, on entire range						
Terminal type		positive safety						
Cable section (ø min./max.)	[mm ²]	2,5 / 16						
Tightening torque	[Nm]	1,2						
Temperature								
storage	[°C]	-40 ... +70						
operating	[°C]	-25 ... +35						
Protection degree		IP20 / IP30 versions with cover						
		M1175	M1173	M1170	M1174	M1363	M1176	M2071
Reference standards		DIN VDE 0620-1	CEI 23-50		NF C 61 303	BS1363	AS NZS 3112	IRAM 2071
Approvals		VDE, GOST	IMQ, GOST	GOST	LCIE, CEBEC, GOST	BSI	RCM	IRAM

Indicator light technical specifications

Type		fluorescent torpedo-shaped lamp
Function		Indication of power supply presence (M1363, M1173, M1175) Indication of plug inserted + power supply presence (M1176, M2071)
Light colour		green
Power consumption	[W]	0,25

Fuse technical specifications

Type		5 x 20 mm up to 6,3 A aM
Function		phase protection
Breaking capacity	[A]	1500
Reference standard		IEC EN 60127



MA1-8001 DIN rail adapter

Through an appropriate kit, this product born with the Modular Range of Pilot devices is the perfect case for alongside Ø 22 mm pilot devices with “System pro M compact” products. The Ø 22 mm pilot devices can now find a greater use even within distribution or automation switchboards with modular panels maintaining an high aesthetic level.

The MA1-8001 offers a lot of advantages:

- Fast and easy mounting
- Simple wiring
- Simple maintenance
- Less depth of operators
- Perfect harmony alongside the “System pro M compact” products

Using MA1-8001 it's possible to put together “System pro M compact” products with LED pilot light, potentiometer, key selectors, toggle switches, selector switches, push- buttons, mushroom buttons and emergency stop, illuminated or not.

For detailed description of the industrial devices that can be installed using this kit, see technical catalogue 1SFC151003C0201

Description	Order details		Bbn	Price	Price	Weight	Pack
	Type code	Order code	7320500	1 piece	group	1 piece	unit
			EAN			kg	pc.
DIN rail adapter KIT (2 modules) ①②	MA1-8001	1SFA611920R8001	357880			0.023	1
DIN rail adapter (2 modules) ①	MA1-8131	1SFA611920R8131	357702			0.020	10

① Can be used only with Modular range pilot devices units; it cannot be used with the old CBK range or Compact range products.
 ② KIT includes one Din rail adapter, one empty block and 2 pins

Technical notes

- To assemble the new housing with push-buttons, selector switch and indicator lamps, contact blocks and lamp blocks for DIN rails must be used.
- The MCBH-00 holder is not necessary, because the housing hooks directly to contact blocks.
- To line up with “System pro M compact” products, a maximum of 3 blocks must be used.
- In the configuration with 3 contacts, it is advisable to use securing pins to make the blocks more solid.
- In making up actuators or indicator lamps that use a single contact, one or two MDB-2 empty blocks must be used.

Assembly instruction

After hooking the contact and/or lamp blocks on the DIN rail, inserting the securing pins (if necessary) and wiring the terminals:

- 1 Insert the push-button, selector or pilot light where desired
- 2 tighten the locking nut using the specific tool
- 3 hook the housing to the empty and/or contact blocks fixed on the DIN rail

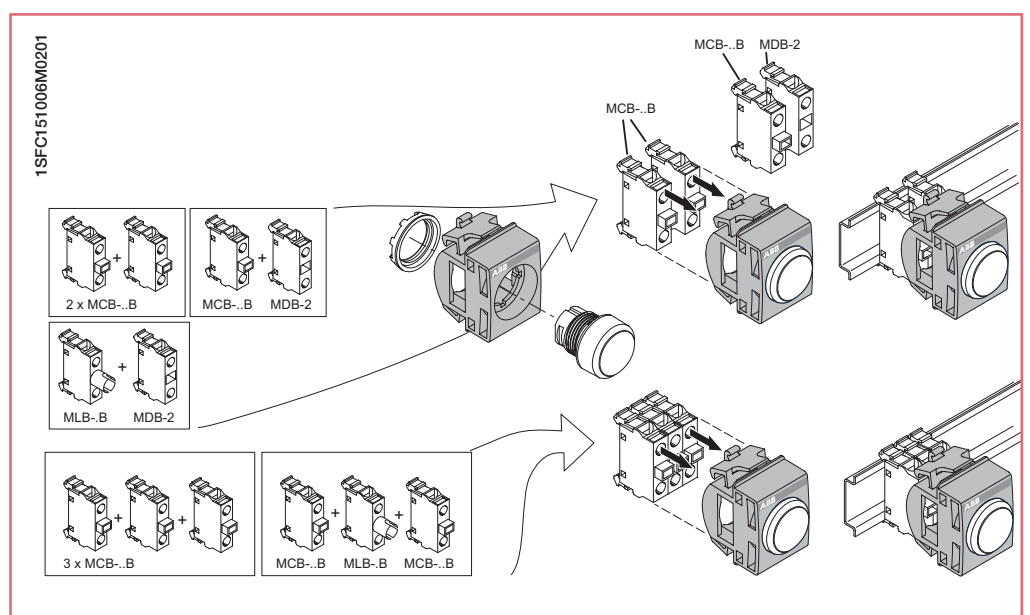



Plug-in systems with Smisline and Unifix

Index

Selection tables

Smisline - Pluggable System.....	10/2
Unifix - Rapid Wiring System	10/3



SMISLINE – Pluggable System

Keeps downtime to a minimum

SMISLINE protection devices are simply snapped into a plug-in socket system. The arduous task of power supply and connection is done. In addition to savings in time and money, another advantage of the system is the quick and easy exchangeability of the devices. If the corresponding spare capacity is planned, subsequent expansion consists merely of plugging in and connecting additional devices.

Customer Benefits with SMISLINE

Reliability and Availability

Fast and easy handling with pluggable devices
Plug-in technology provides 24-hour service, 365 days a year

Freedom in concept and design

Mix of devices, various power supply options
Flexible architecture without risk of damage to life and property

Upgradeability

Easy integration of new devices
Upgrade without changing the existing installation

For order codes and technical details please check the SMISLINE catalogue **2CCC451028C0204** or go to ABB Homepage.

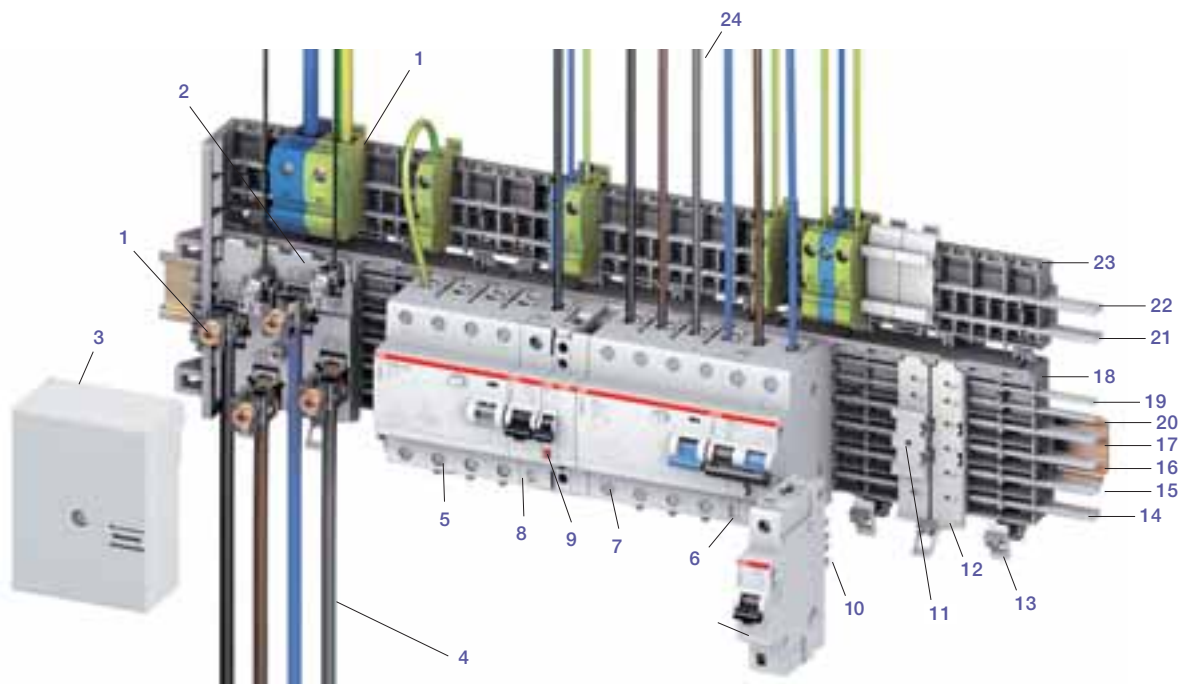

- | | | |
|---|------------------------------------|-----------------------------------|
| 1 Supply terminal | 8 Miniature circuit breaker S401 M | 17 Busbar N |
| 2 Incoming terminal block with a max. current rating of 160A 50 mm ² (2 x 25 mm ²) + 2 x 10 mm ² (LA, LB) | 9 Signal contact | 18 Sockets, 8-module and 6-module |
| 3 Cover for incoming terminal block | 10 Plug contacts | 19 Auxiliary busbar LA |
| 4 Supply cable | 11 DIN adapter | 20 Auxiliary busbar LB |
| 5 Surge arrester OVR404 | 12 Spare way cover | 21 Busbar N, external |
| 6 RCBO FS401 | 13 Device latch | 22 Busbar PE, external |
| 7 Residual-current circuit breaker F404 | 14 Busbar L3 or DC +, - | 23 Additional socket |
| | 15 Busbar L2 or DC +, - | 24 Output circuits |
| | 16 Busbar L1 or DC +, - | |



2CSC400220F0202

UNIFIX – Rapid Wiring System

Keeps downtime to a minimum

UNIFIX makes bench pre-cabing possible, with installation in the switchboard only carried out at a later time, without any limit to the types or combination of apparatus you may need to install... and this becomes even easier, thanks to the rigid coupled connectors, standardized for the different types of apparatus.

Unifix H allows modular and moulded-case circuit-breakers up to 250A to be mounted on an apparatus frame, which can be connected directly to the rear busbar system. This means many fewer conductors circulating inside the switchboard with considerable advantages in terms of space taken up, connections needed to be checked, and cabling times, with consequent cost savings.

Unifix L means traditional wire cabling on the supply side of the circuit-breakers can be replaced. It is thanks to the characteristics of its connections that cabling can be done rapidly and without any possibility of error, obtaining a more essential switchboard without conductors and cabling ducts around. Flexibility is its strong point: several independent circuits can be realized on the same DIN rail, and circuit-breakers of different types, with different polarity and characteristics can be mounted.

Customer Benefits with UNIFIX

Wiring Time

The use of Unifix reduces considerably wiring time.

Use of Standard Devices

Unifix can be applied to all standard versions of ABB Sace modular devices, Tmax T1 - T2 - T3 - XT1 - XT3 moulded-case circuit breakers

Flexible

Unifix has variable modular capacity, it is possible to place both circuit-breakers with different polarities side by side on the same line and auxiliary elements.

Reduce Space

Space taken up by Unifix is extremely low

For order codes and technical details please check the **Distribution Switchgear Catalogue 1STC008001D0201**, pages 3/15-16, 4/15-16, 5/36-37, or go to ABB Homepage.

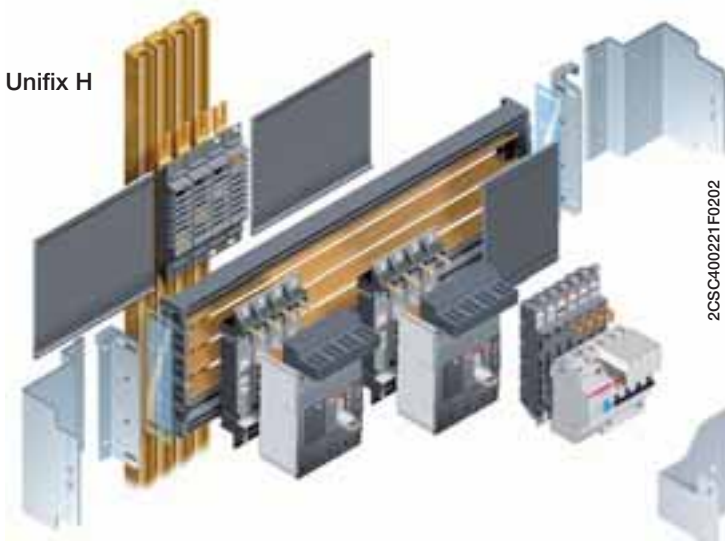

Unifix H

2CSC400221F0202

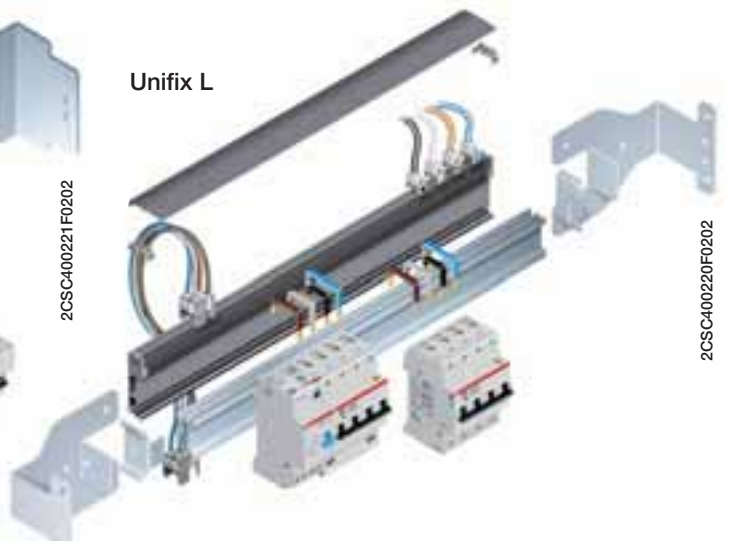

Unifix L

2CSC400220F0202

Index

MCBs

Tripping characteristics	11/2
Limitation of specific let-through energy I^2t	11/7
Peak current I_p	11/21
Coordination tables	11/28
MCBs internal resistance, power loss and max. permissible earth-fault loop impedance ..	11/65
Performances at different ambient temperatures, altitudes and frequencies	11/68
Use of MCBs in direct current circuits	11/70
Particular supply sources and loads	11/72
Double stamping of S 200 P	11/74
Wiring diagrams of MCBs	11/75

RCDs

Functions and classification criteria for RCDs	11/76
Influence on RCDs of currents with DC components	11/79
Coordination tables	11/80
Power loss, derating and performance in altitude	11/84
Emergency stop using DDA 200 AE series	11/85
Unwanted tripping - AP-R solution	11/86
Unwanted tripping - F2C-ARH solution	11/88
Type B RCDs	11/89
Use of 4P RCCBs in 3-phase system without neutral pole.....	11/94
Operating voltage of test button	11/95
Wiring diagrams of RCCBs, RCBOs and RCD-blocks.....	11/100

Electronic residual current devices

RD2 residual current relays	11/103
RD3 residual current relays	11/104
RD front panel residual current relays	11/110
Toroidal transformers.....	11/117

SPDs

Terminology of SPD electrical characteristics	11/119
Common mode and/or differential mode protection.....	11/120
Principle of coordination for Surge Protective Devices.....	11/121
Operating diagrams of Surge Protective Devices	11/122
Installation rules for SPDs: choice of associated	
Breaking devices (fuse/circuit breaker)	11/125
Cabling and installation of Surge Protective Devices in an electrical panel.....	11/126

MDRCs

Protection devices

E 90 fuse-holders	11/127
E 930 fuse-holders	11/129
EPD24 electronic protection devices	11/130
Insulation monitoring devices	11/133
QSO switchboard for medical locations.....	11/142

Command devices

E 259 installation relays.....	11/144
E 250 latching relays	11/145
ATT-Tool.....	11/147

Measurement devices

Analogue and digital measurement instruments and accessories.....	11/152
---	--------

Other functions

Modular transformers	11/170
Control, isolating and safety transformers	11/171
Modular sockets selection table	11/176

Tripping characteristics

Acc. to	Tripping characteristic and rated current	Thermal release ②		Tripping time	Electromagnetic release ①		Tripping time
		Current: conventional non-tripping c.	conventional tripping c.		Currents: hold current surges	trip at least at	
IEC/EN 60898-1	B 6 to 63 A	$1.13 \cdot I_n$	$1.45 \cdot I_n$	> 1 h < 1 h	$3 \cdot I_n$	$5 \cdot I_n$	> 0.1 s < 0.1 s
	C 0.5 to 63 A	$1.13 \cdot I_n$	$1.45 \cdot I_n$	> 1 h < 1 h	$5 \cdot I_n$	$10 \cdot I_n$	> 0.1 s < 0.1 s
	D 0.5 to 63 A	$1.13 \cdot I_n$	$1.45 \cdot I_n$	> 1 h < 1 h	$10 \cdot I_n$	$20 \cdot I_n$	> 0.1 s < 0.1 s
IEC/EN 60947-2	K 0.5 to 63 A	$1.05 \cdot I_n$	$1.2 \cdot I_n$	> 1 h < 1 h	not applicable		
		$1.05 \cdot I_n$	$1.2 \cdot I_n$	> 2 h < 1 h ③	$10 \cdot I_n$	$14 \cdot I_n$	> 0.2 s < 0.2 s
IEC/EN 60947-2	Z 0.5 to 63 A	$1.05 \cdot I_n$	$1.2 \cdot I_n$	> 1 h < 1 h	not applicable		
		$1.05 \cdot I_n$	$1.2 \cdot I_n$	> 2 h < 1 h ③	$2 \cdot I_n$	$3 \cdot I_n$	> 0.2 s < 0.2 s

① The indicated tripping values of electromagnetic tripping devices apply to a frequency range of 16 2/3...60 Hz. In the case of diverging frequencies or direct current, see paragraph "Variation of tripping threshold of MCBs, according to network frequency" (page 6/7)

② The thermal releases are calibrated to a nominal reference ambient temperature; for Z and K, the value is 20 °C, for B and C = 30 °C. In the case of higher ambient temperatures, the current values fall by ca. 6 % for each 10 K temperature rise.

③ As from operating temperature (after $I_1 > 1$ h or, as applicable, 2 h).

Tripping behavior S 700

Tripping characteristic	Rated current	Delayed thermal release			Short-time delayed selective tripping device		
		Conventional non-tripping current ①	Conventional tripping current ①	Tripping time	Delayed tripping	Short-time delayed tripping	Tripping time
		I_{int}	I_{it}	t	I_{itv}	I_{itk}	t
E	10 to 100 A	$1.05 \times I_n$		≥ 2 h	$5 \times I_n$		$0.05 \text{ s} < t < 5 \text{ s} (I_n \leq 32 \text{ A})$ $0.05 \text{ s} < t < 10 \text{ s} (I_n > 32 \text{ A})$
			$1.2 \times I_n$	< 2 h		$6.25 \times I_n$	$0.01 \text{ s} < t < 0.3 \text{ s}$
K	16 to 50 A	$1.05 \times I_n$		≥ 2 h	$10 \times I_n$		$0.05 \text{ s} < t < 5 \text{ s} (I_n \leq 32 \text{ A})$ $0.05 \text{ s} < t < 10 \text{ s} (I_n > 32 \text{ A})$
			$1.2 \times I_n$	< 2 h		$14 \times I_n$	$0.01 \text{ s} < t < 0.3 \text{ s}$
	63 to 100 A	$1.05 \times I_n$		≥ 2 h	$8 \times I_n$		$0.05 \text{ s} < t < 10 \text{ s}$
			$1.2 \times I_n$	< 2 h		$12 \times I_n$	$0.01 \text{ s} < t < 0.3 \text{ s}$

① The thermal trip values refer to a reference temperature of 20 °C. For higher ambient temperatures the current rating will be reduced by 3 % per 10 °C decrease.

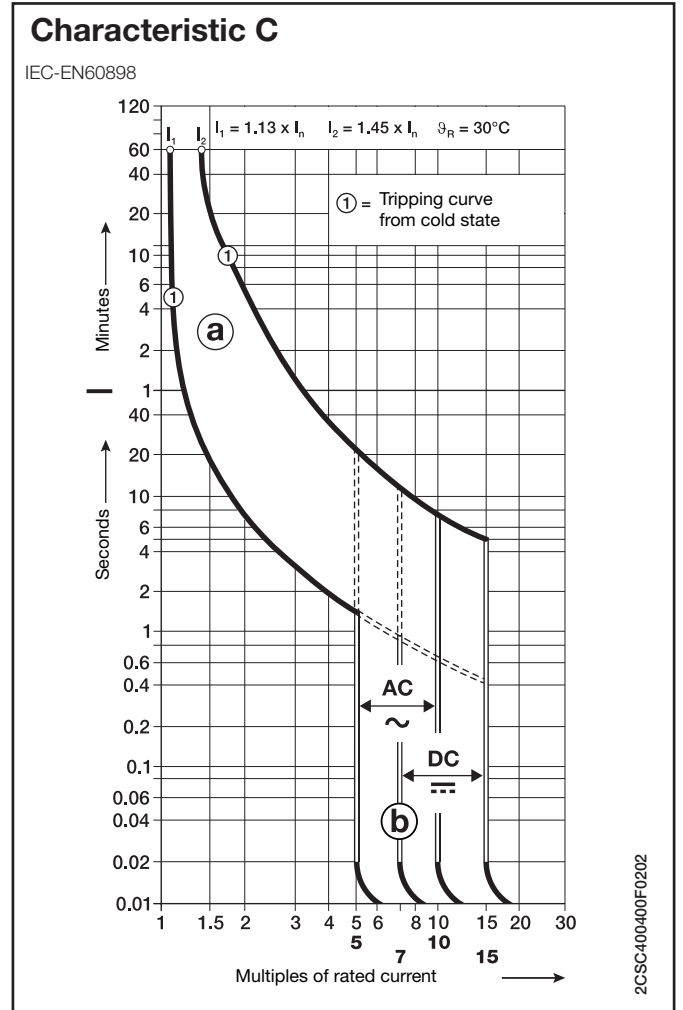
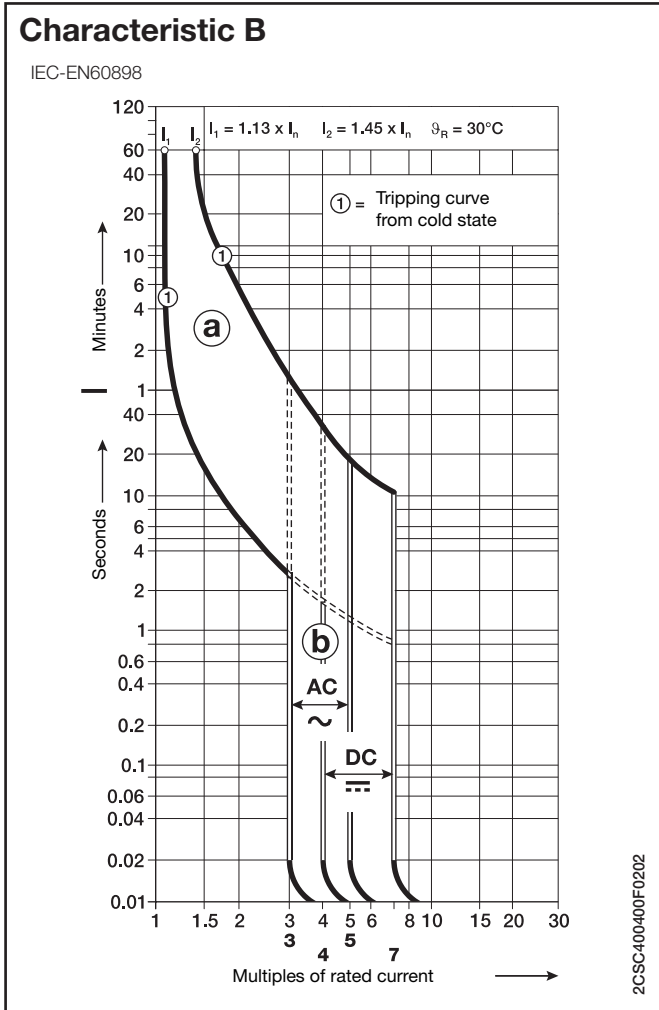

- Ⓐ thermal trip
- Ⓑ electromagnetic trip

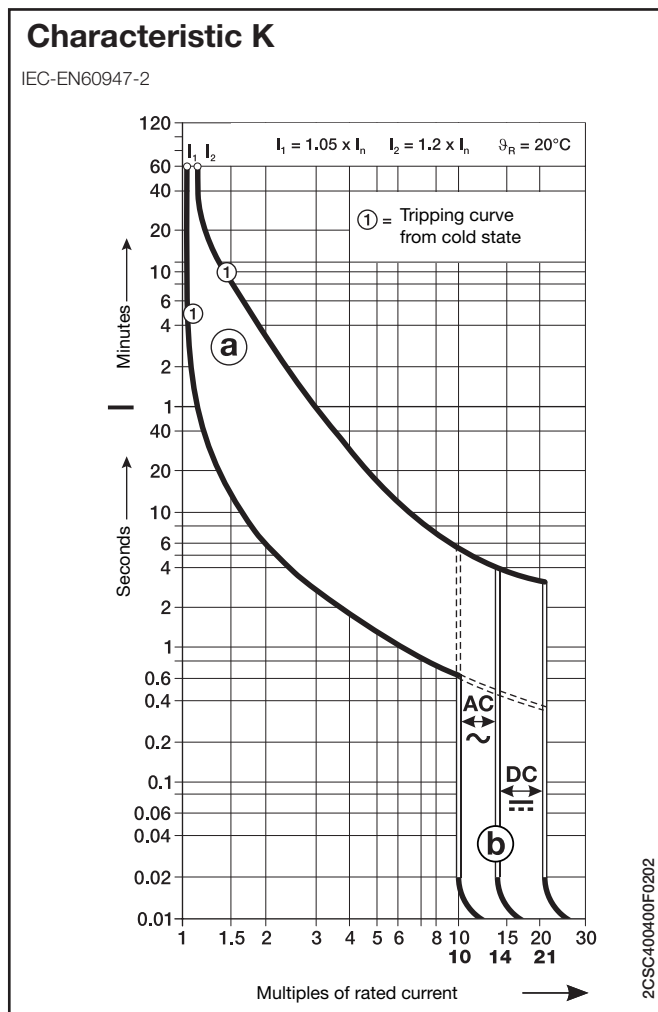
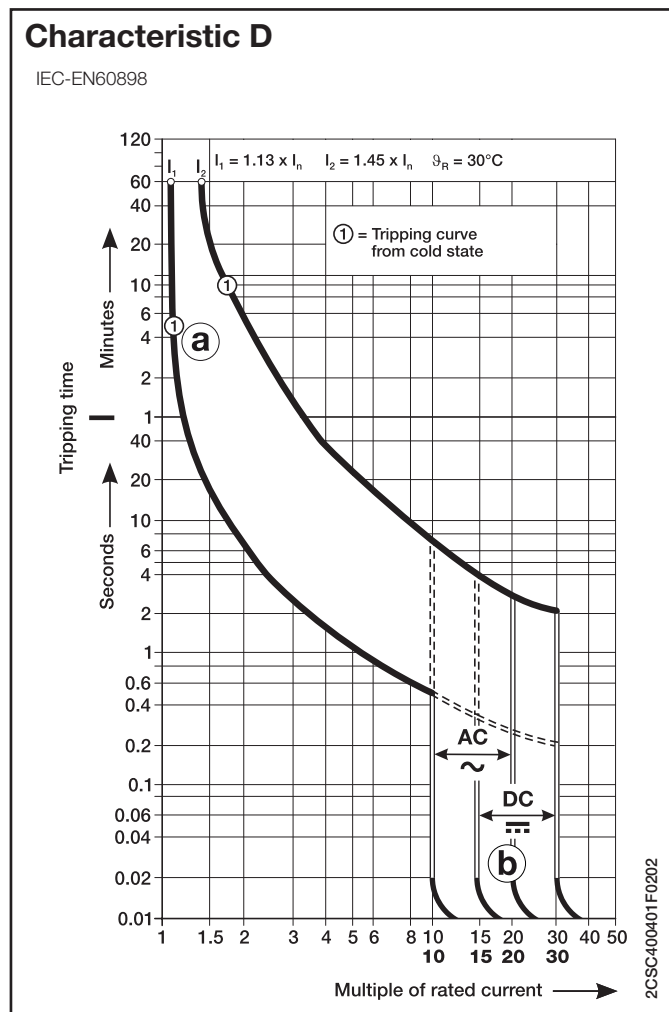

- Ⓐ thermal trip
- Ⓑ electromagnetic trip

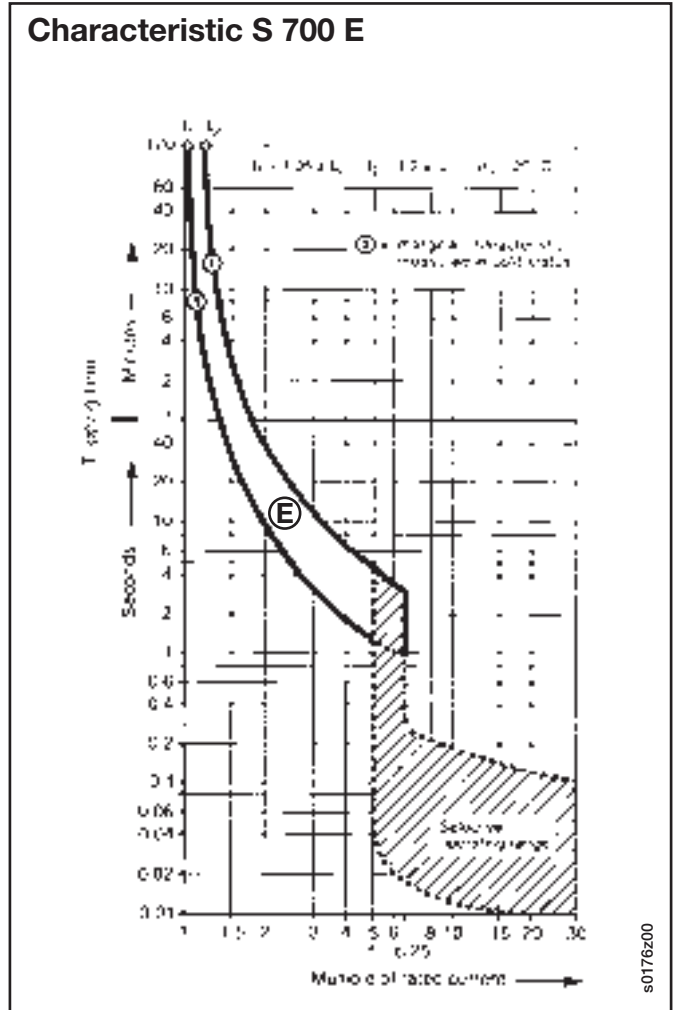
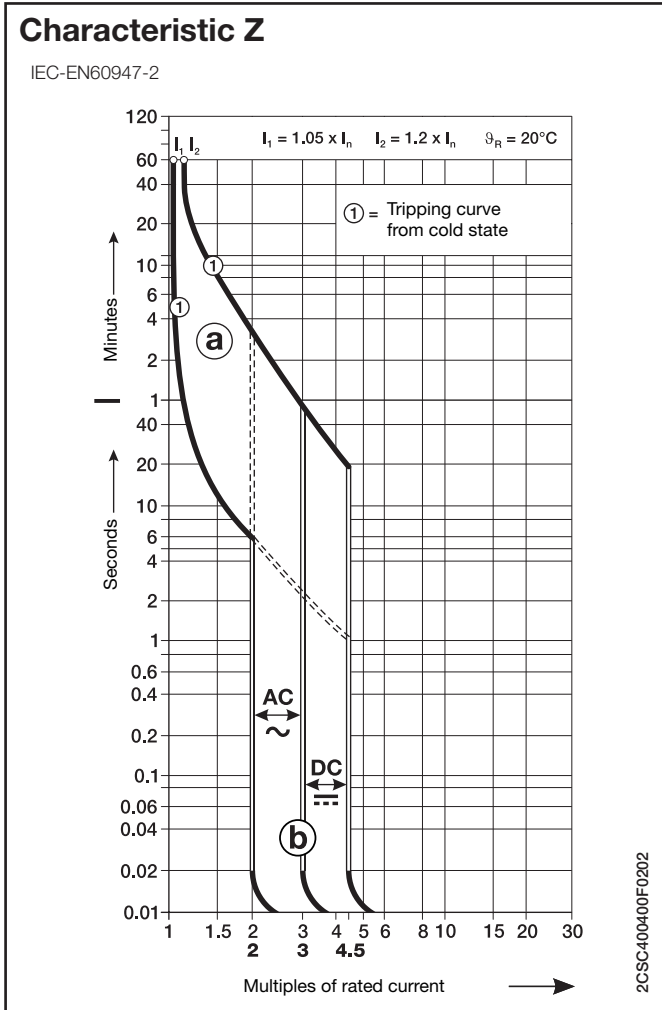

- Ⓐ thermal trip
- Ⓑ electromagnetic trip

Characteristic S 700 K - K 16 to K 50

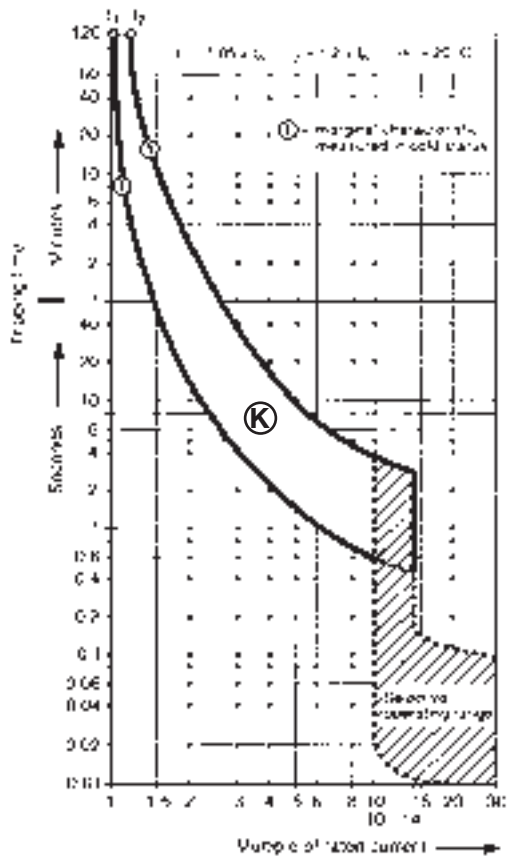

S0175Z00

Characteristic S 700 K - K 63 to K 100

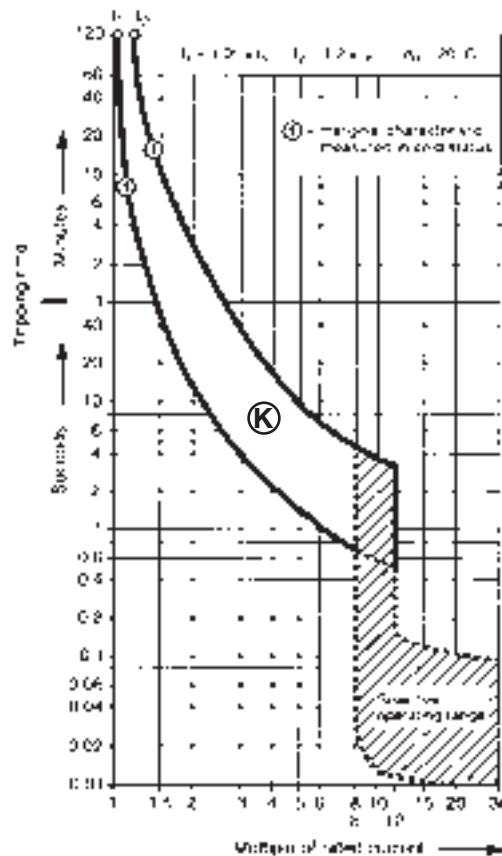

S0174Z00

- (a) thermal trip
- (b) electromagnetic trip

Limitation of specific let-through energy

Tripping of an installation circuit by circuit-breaker when there is a short-circuit requires a certain amount of time depending on the characteristics of the circuit-breaker and the entity of the short-circuit current. During this period of time, some or all of the short-circuit current flows into the installation; the parameter I^2t defines the “specific let-through energy”, ie. the specific energy that the breaker allows through when there is a short-circuit current I_{cc} during the tripping time t .

In this way, we can determine the capacity of a circuit-breaker to limit, ie. break high currents up to the rated breaking power of the device, by reducing the peak value of the above-mentioned currents to a value which is considerably lower than the estimated current.

This can be achieved using mechanisms which open very rapidly and have the following advantages:

- they limit the thermal and dynamic effects both on the circuit-breaker and on the protected circuit;
- they reduce the dimensions of the current-limiting circuit-breaker without reducing breaking capacity;
- they considerably reduce ionized gases and sparklers emitted during the short-circuit and therefore they avoid the danger of ignition and fires.

I_{rms} = perspective symmetrical short-circuit current

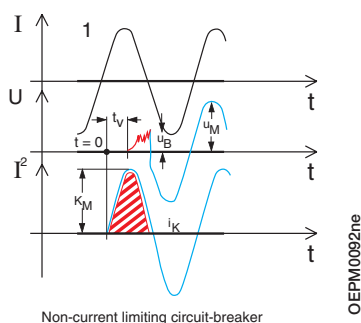

OEPM0092ne

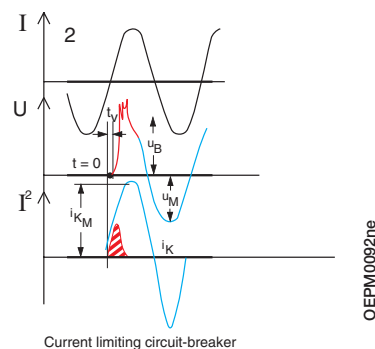

OEPM0092ne

Oscillogram of short-circuit breaks on two circuit-breakers:

- 1** = traditional non-current limiting circuit-breaker
- 2** = current limiting circuit-breaker
- u_B = arc voltage (red)
- u_M = rest voltage (blue)

Short-circuit current

- red** = effective short-circuit current squared
- blue** = estimated short-circuit current squared (shunted circuit-breaker)
- i_{K_M} = maximum values of symmetrical component of short-circuit current squared
- shaded in red** = specific let-through energy in two cases

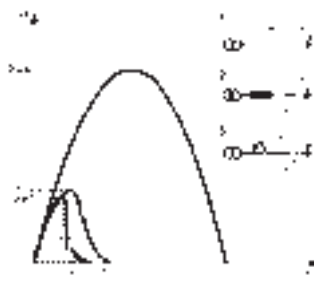

Limiting of let-through energy

Main selective circuit breakers like S 700 support downstream mcbs in clearing short-circuit currents. They additionally reduce let-through energies without tripping. This increases the operational availability of the electrical supply and reduces drawbacks to the feeding grid and the installed equipment.

s0079z01

Max. withstanding specific let-through energy of cables

Section mm²	PVC	EPR	HEPR
50	33,062,500	39,062,500	51,122,500
35	16,200,625	19,140,625	25,050,025
25	8,265,625	9,765,625	12,780,625
16	3,385,600	4,000,000	5,234,944
10	1,322,500	1,562,500	2,044,900
6	476,100	562,500	736,164
4	211,600	250,000	327,184
2.5	82,656	97,656	127,806
1.5	29,756	35,156	46,010

The selection of the cables depends both from the breakers' specific let-through energy and from carrying capacity and voltage drop of the line.

Data of the previous table are referred to the following cables:

PVC	EPR	HEPR
FM9	H07RN-F	N07G9-K
FM9OZ1		FTG10OM1
N07V-K		RG7OR
FROR		FG7OM1
		FG7OR

Designation

Cable's reference to the standards	harmonized	H
	national cable recognized by CENELC	A
Rated voltage U₀/U	100/100 ≤ U ₀ /U < 300/300	01
	300/300 V	03
	300/500 V	05
	450/750 V	07
	750/1000 V	1
Insulating materials and non-metallic sheath	ethylene-vinylacetate	G
	mineral	M
	polyvinyl chloride	V
Conductor's shape	flexible conductor of a cable for fixed installation	K

Some cables on the market are identified with different names according with the designation UNEL 35011.

I^2t diagrams - Specific let-through energy value I^2t

The I^2t curves give the values of the specific let-through energy expressed in A^2s (A=amps; s=seconds) in relation to the perspective short-circuit current (I_{rms}) in kA.

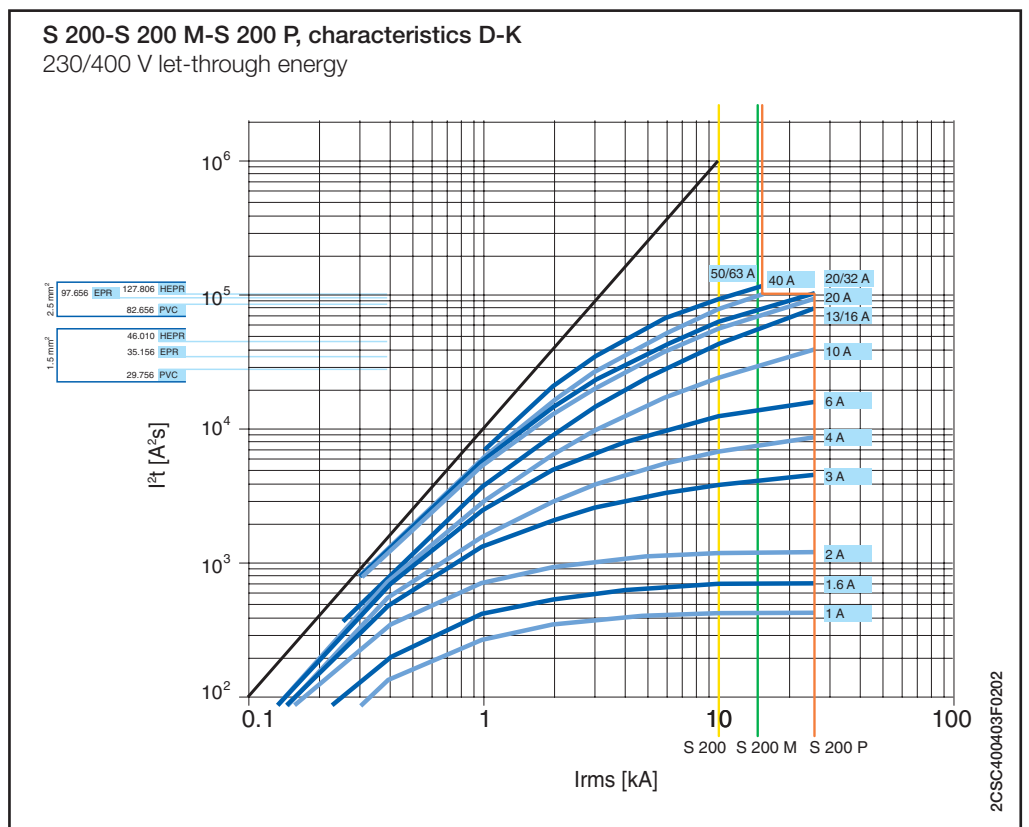
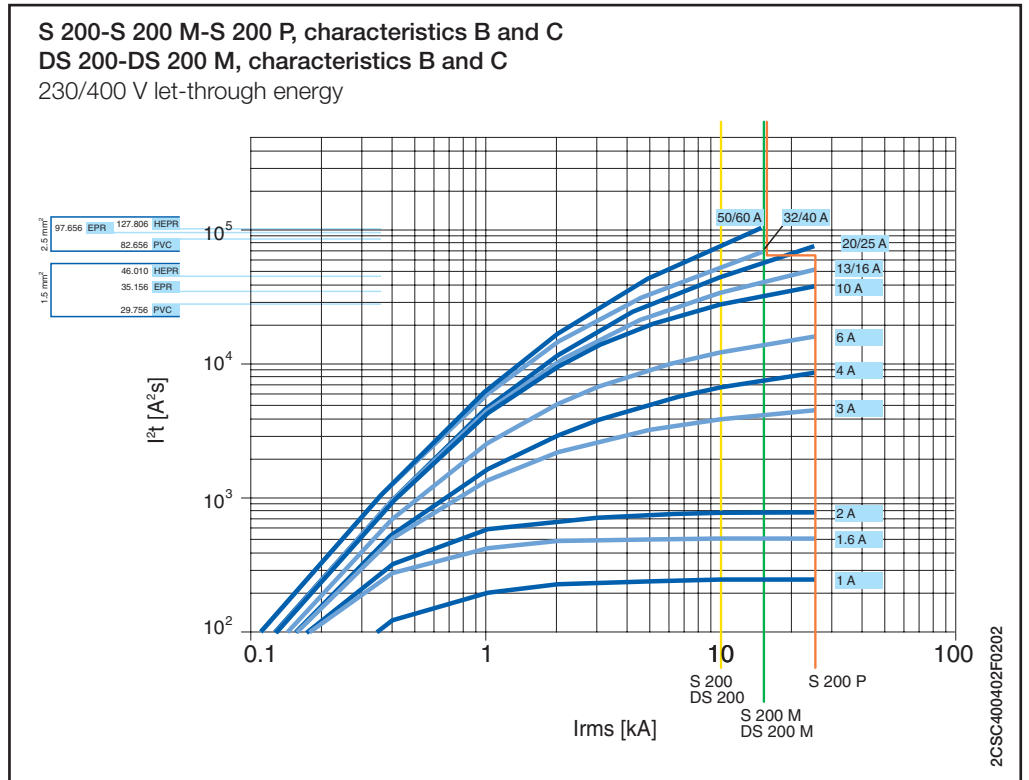

For further information about the selection of the cable, please look at the table in page 10/3

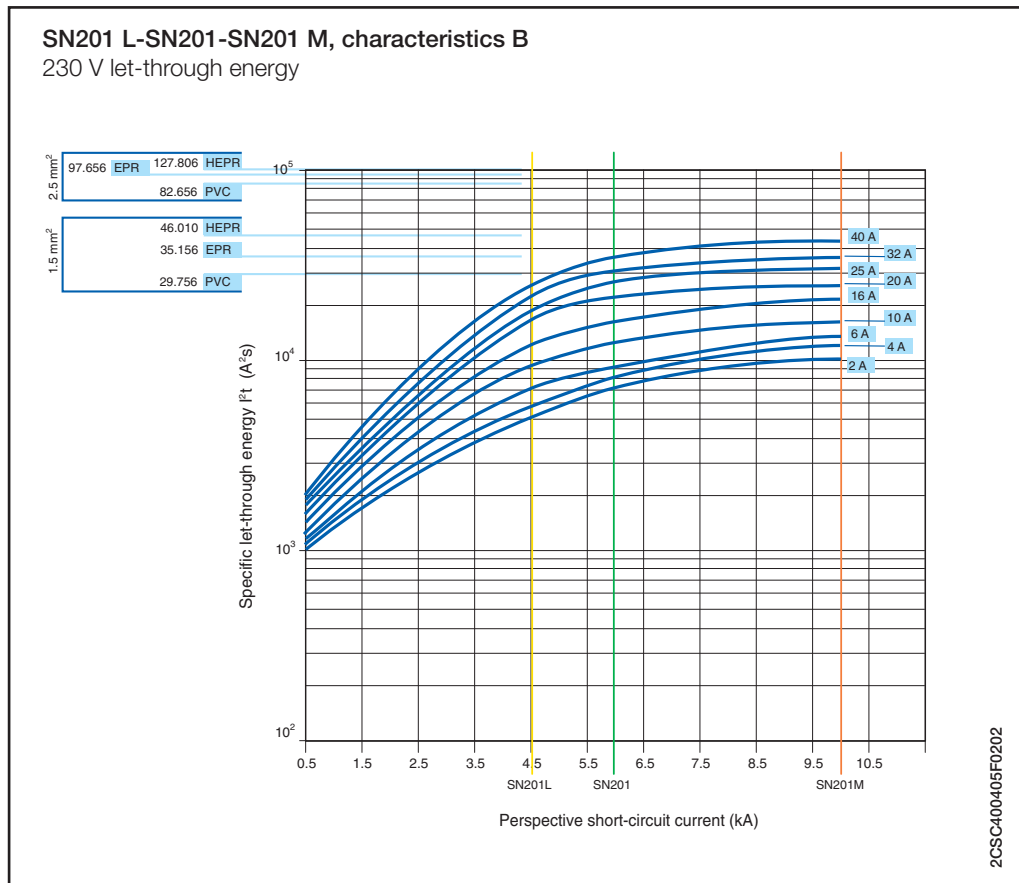
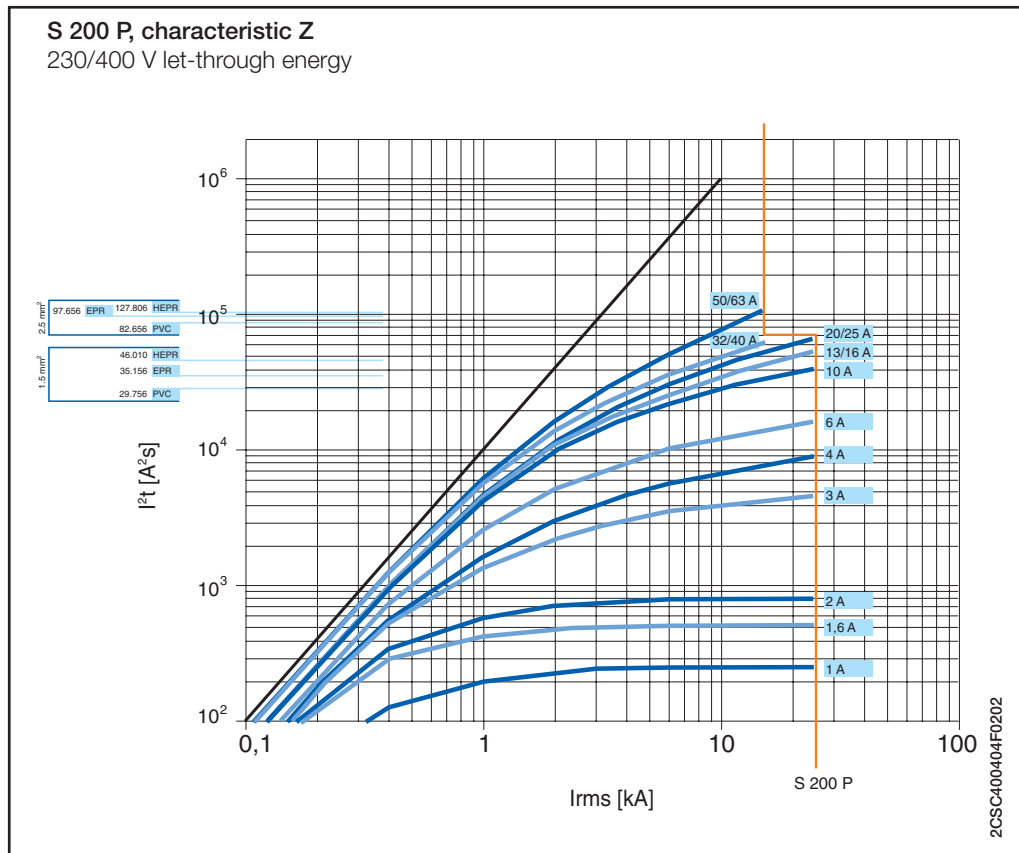

For further information about the selection of the cable, please look at the table in page 10/3

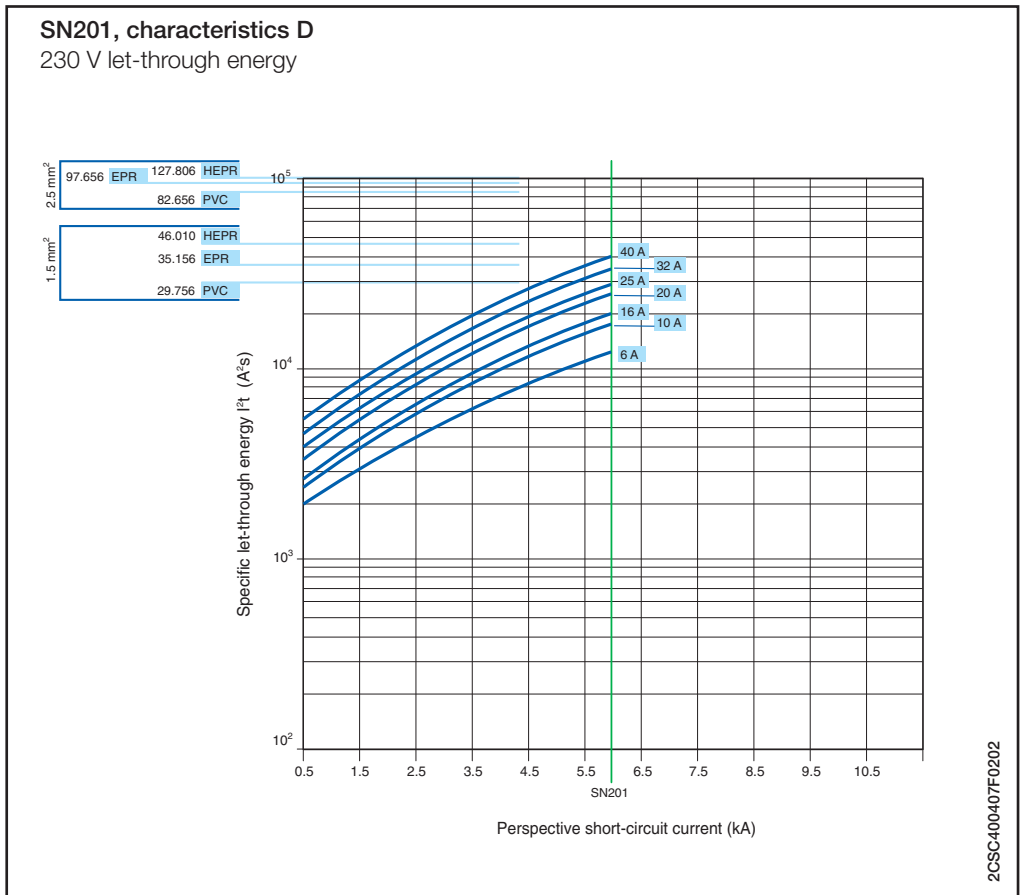
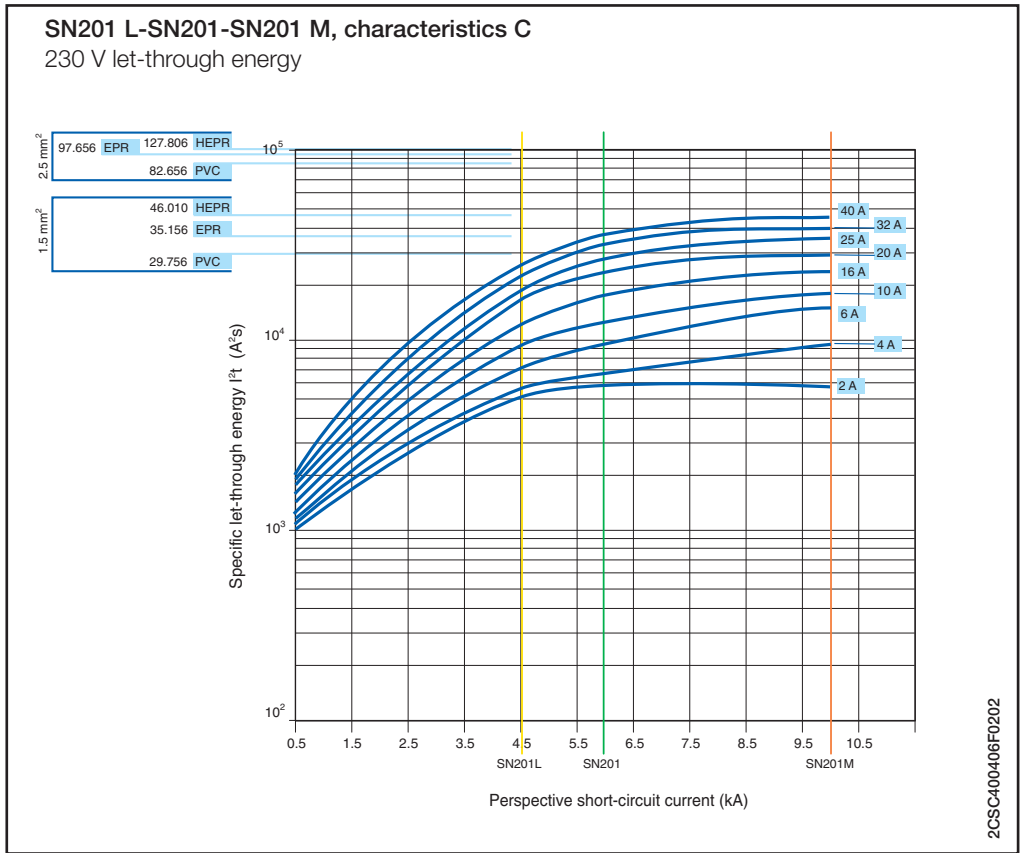

S 280 80-100 A, characteristic B
230/400 V let-through energy

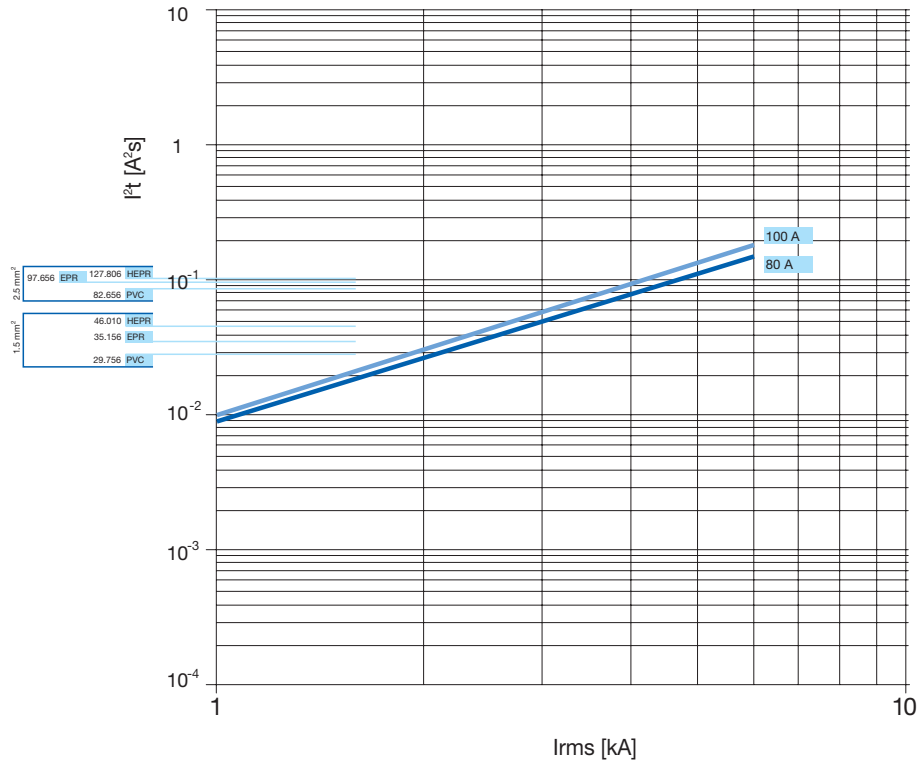

2CSC400408F0202

S 280 80-100 A, characteristic C
230/400 V let-through energy

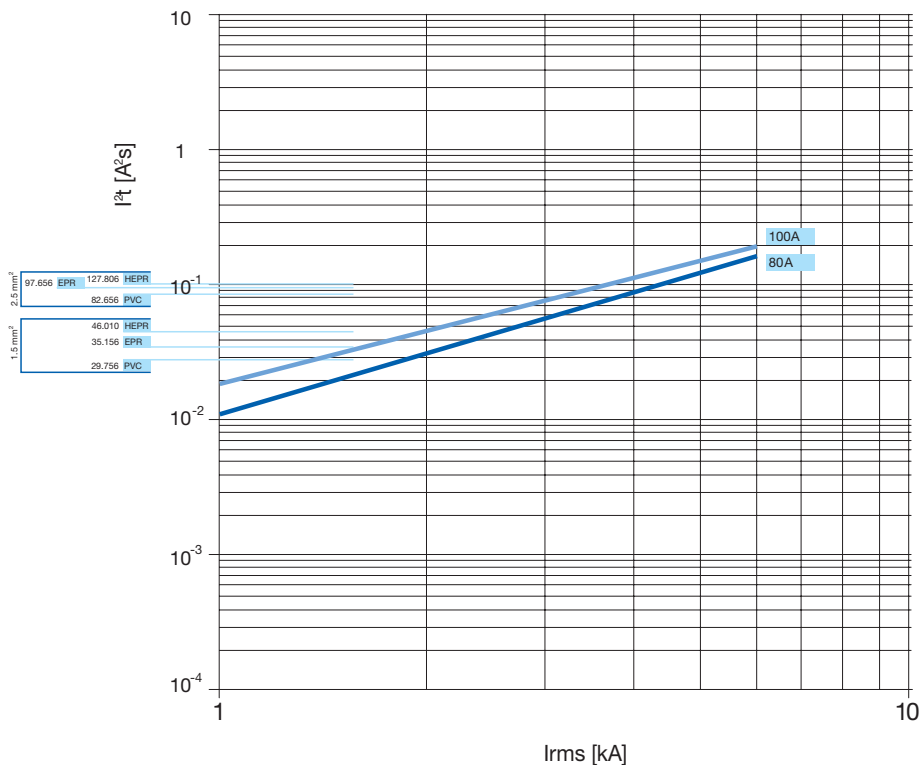

2CSC400408F0202

For further information about the selection of the cable, please look at the table in page 10/3

S 280 characteristics K, Z
230/400 V let-through energy

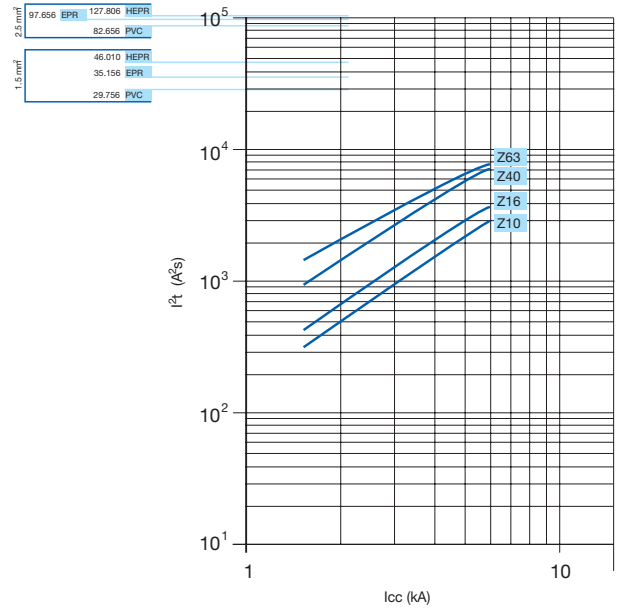
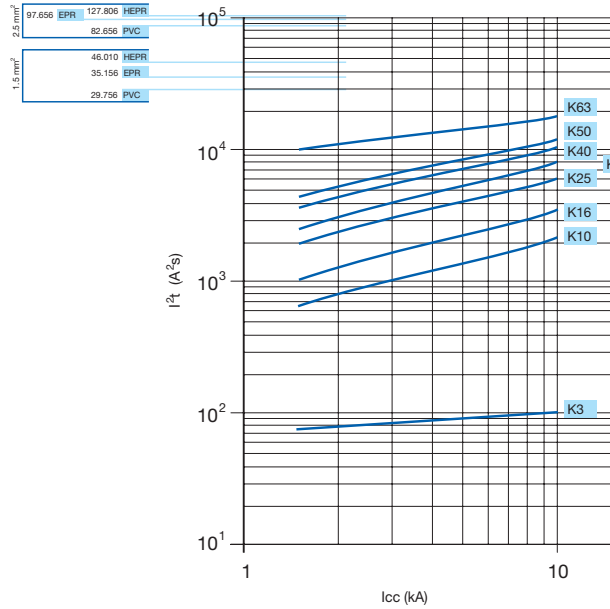

2CSC400410F0202

S 290 characteristics B
230/400 V let-through energy

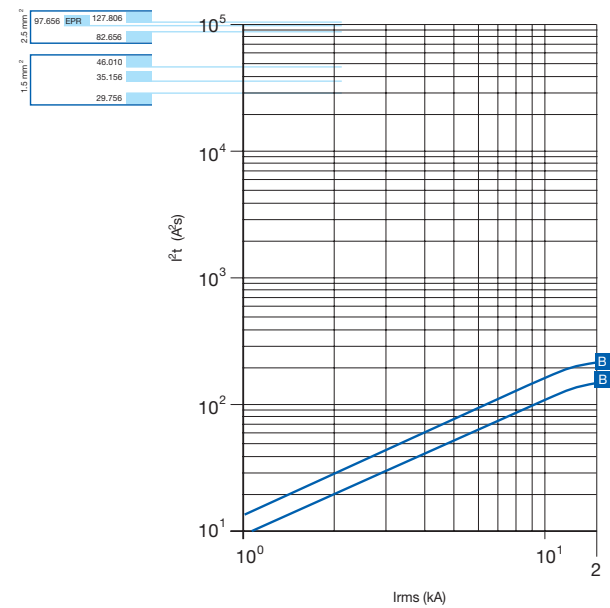

S 290 characteristics C, D, K
230/400 V let-through energy

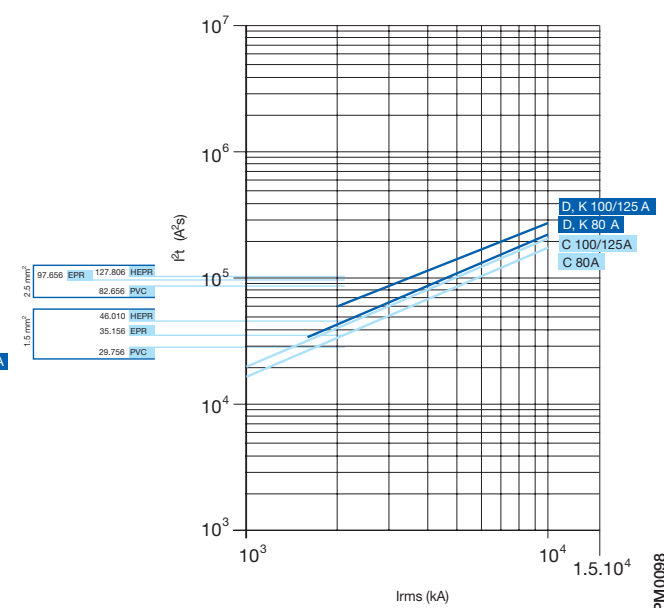

OEPW0098

For further information about the selection of the cable, please look at the table in page 10/3

S 700 characteristic E
let-through energy

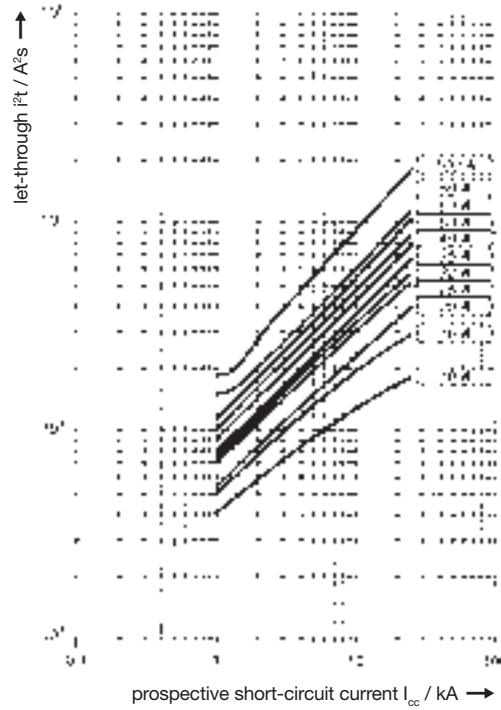

2CDC 022 160 F0103

S 700 characteristic K
let-through energy

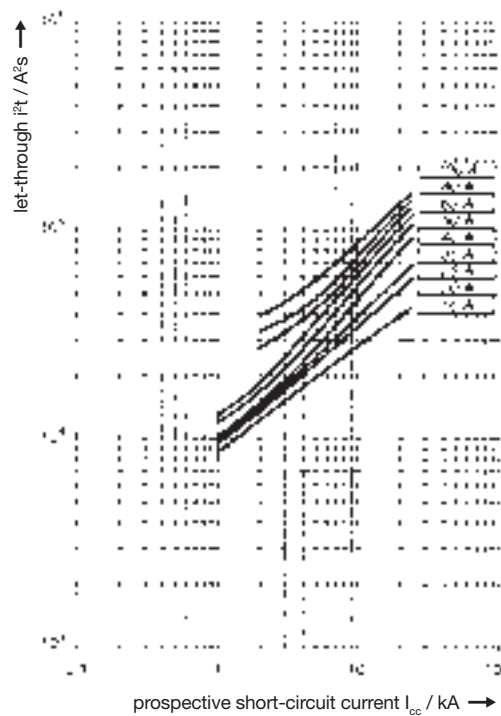

2CDC 022 162 F0103

S 700 characteristic E
 let-through peak current (I_{peak})

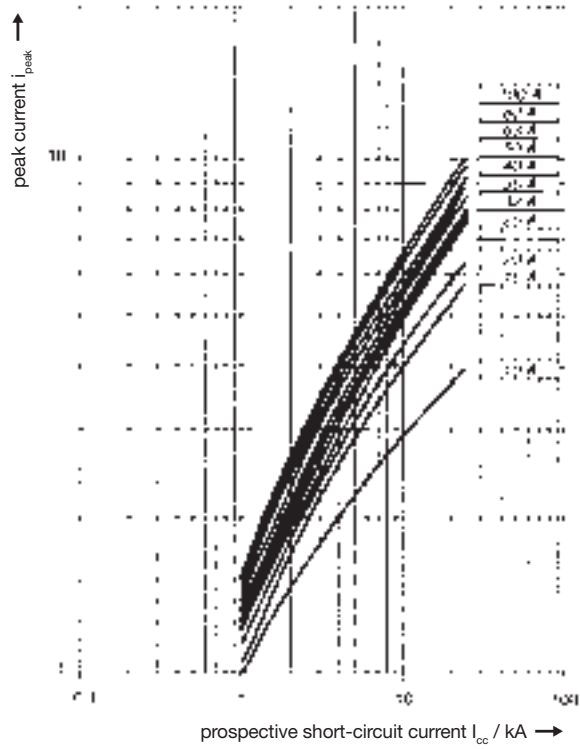

2CDC 022 164 F0103

S 700 characteristic K
 let-through peak current (I_{peak})

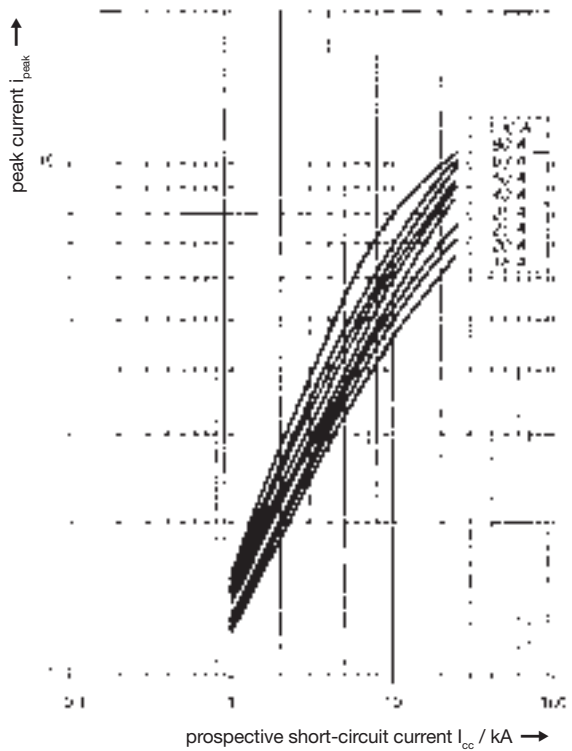

SK 0276 Z 02

S800 S characteristics B, C, K and D
230 V let-through energy

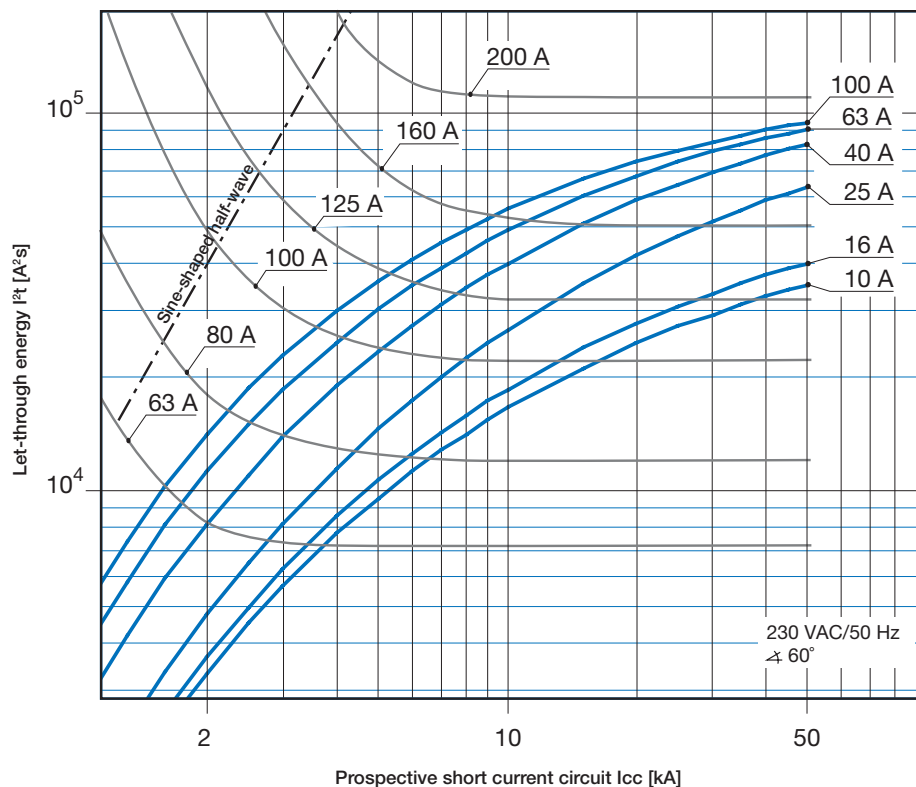
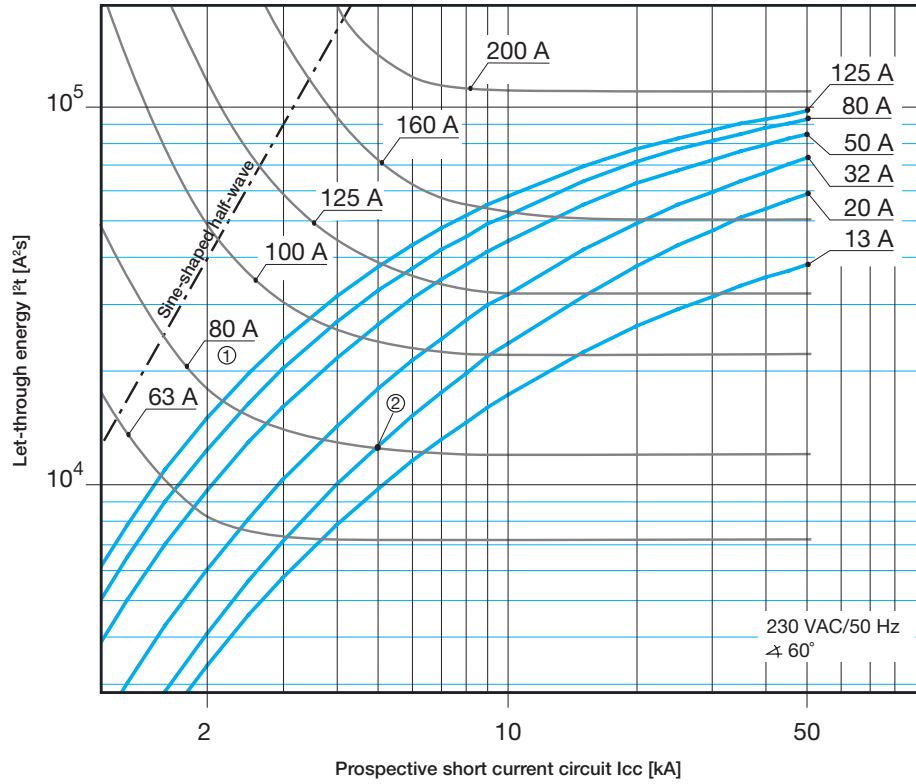

① Min. pre-arcing I^2t , e.g. NH80 A gL/gG
② Max. let-through I^2t , e.g. S801S-C20

S800 S characteristics B, C, K and D
400 V let-through energy

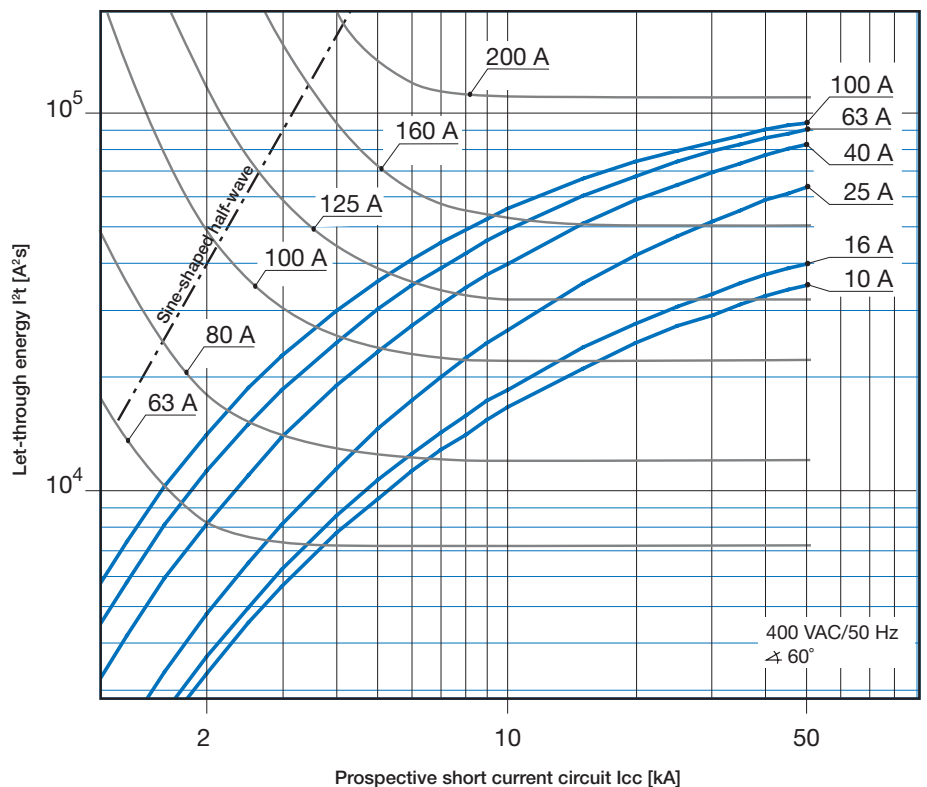
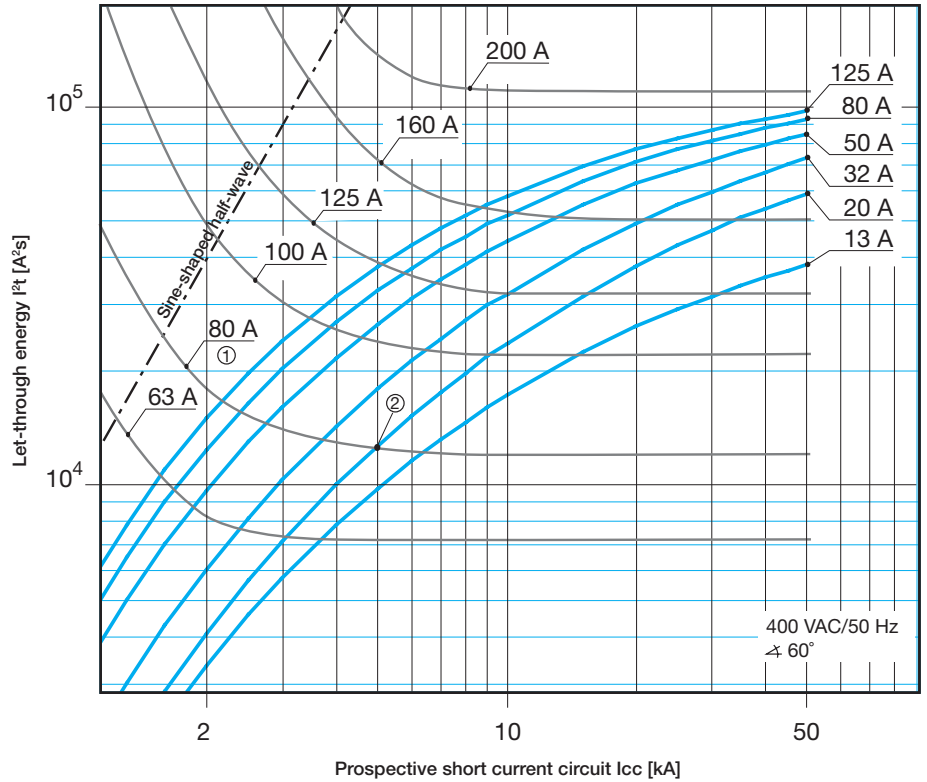

① Min. pre-arcing I^2t , e.g. NH80 A gL/gG
② Max. let-through I^2t , e.g. S801S-C20

S800 N characteristics B, C and D
230 V let-through energy

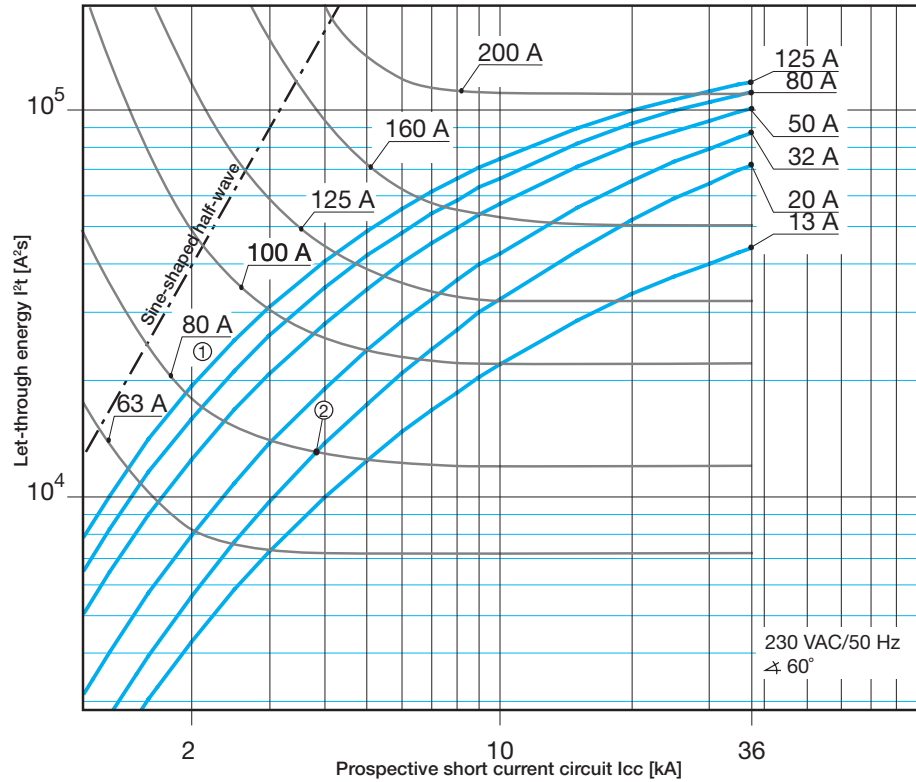

2CCC413028Z0002

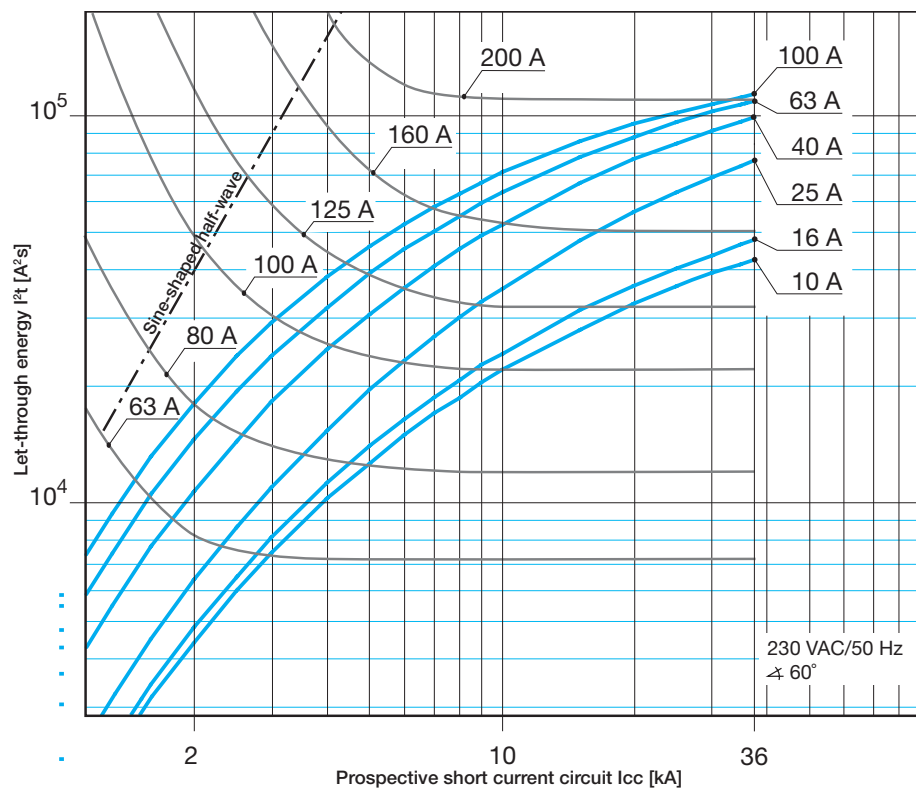

2CCC413028Z0002

① Min. pre-arcing I^2t , e.g. NH80 A gL/gG
② Max. let-through I^2t , e.g. S801S-C20

S800 N characteristics B, C and D
400 V let-through energy

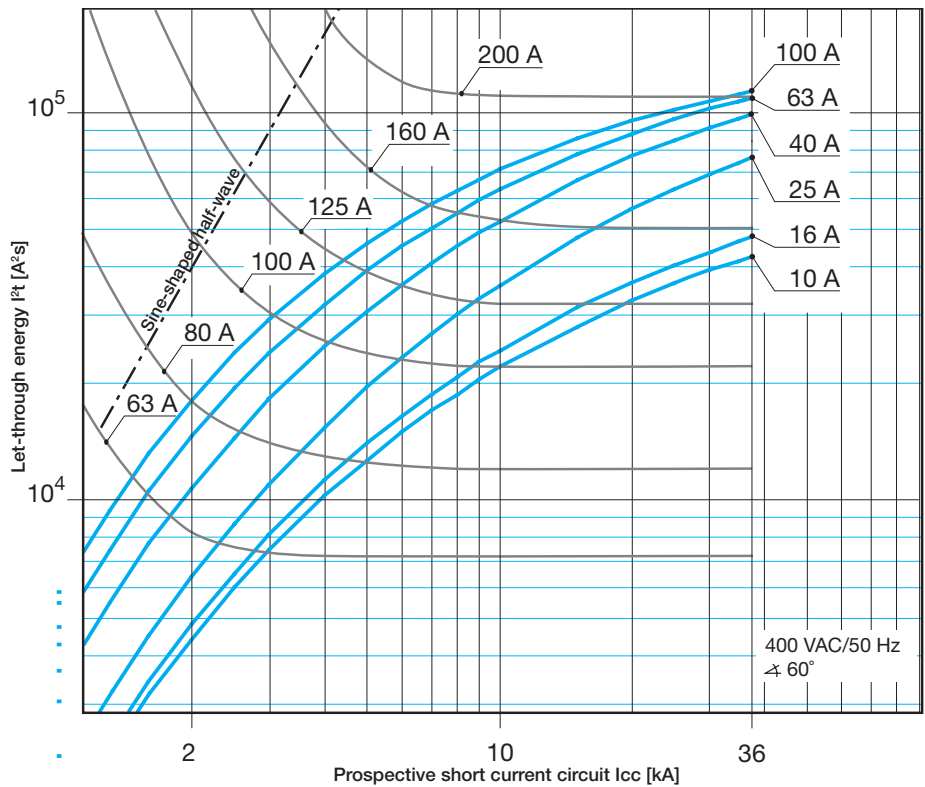
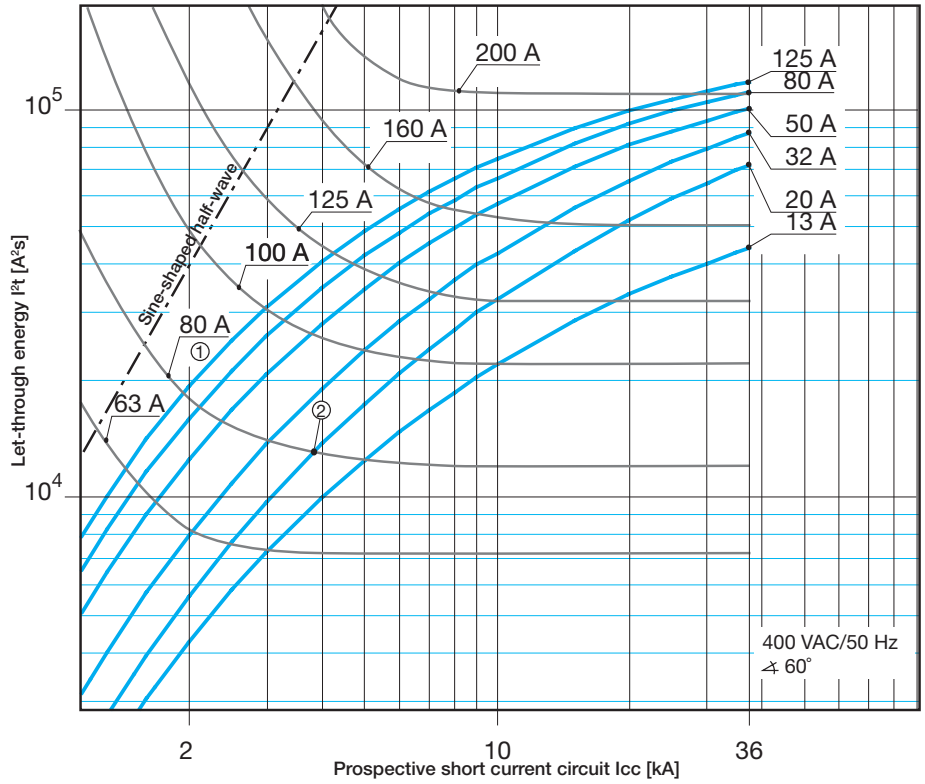

① Min. pre-arcing I^2t , e.g. NH80 A gL/gG
② Max. let-through I^2t , e.g. S801S-C20

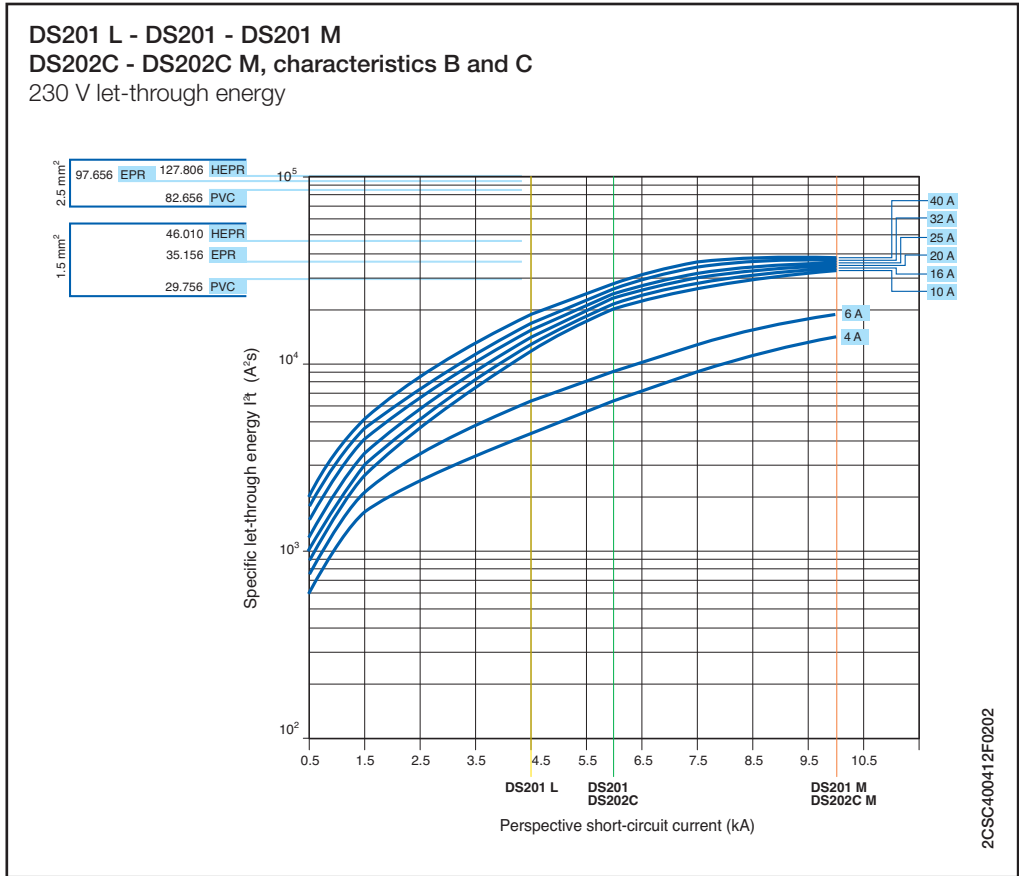

Limitation curves - Peak current values

The I_p curves give the values of the peak current, expressed in kA, in relation to the perspective symmetrical short-circuit current (kA).

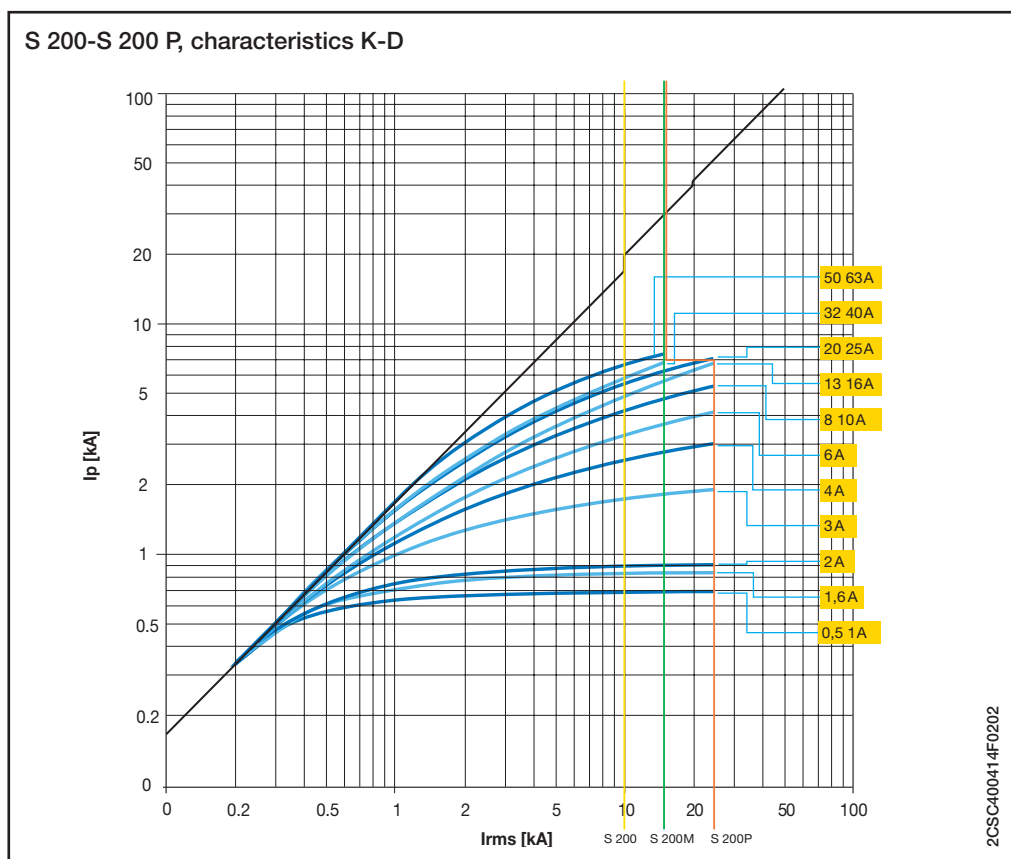
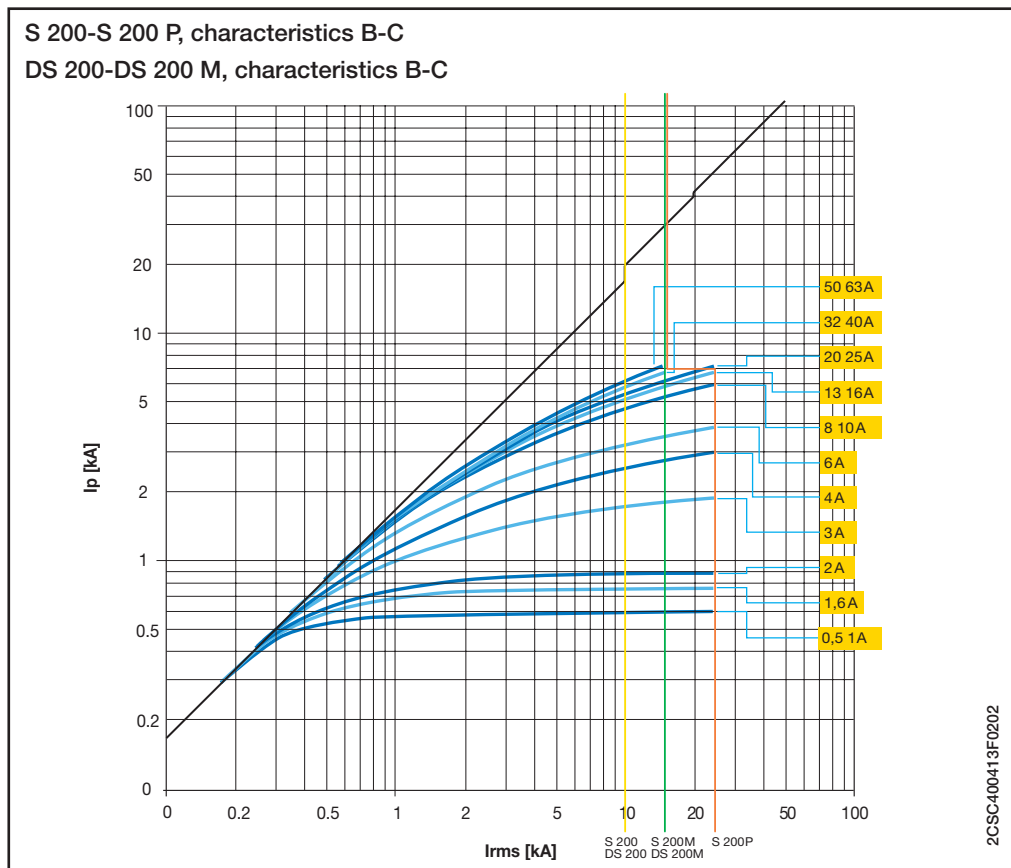

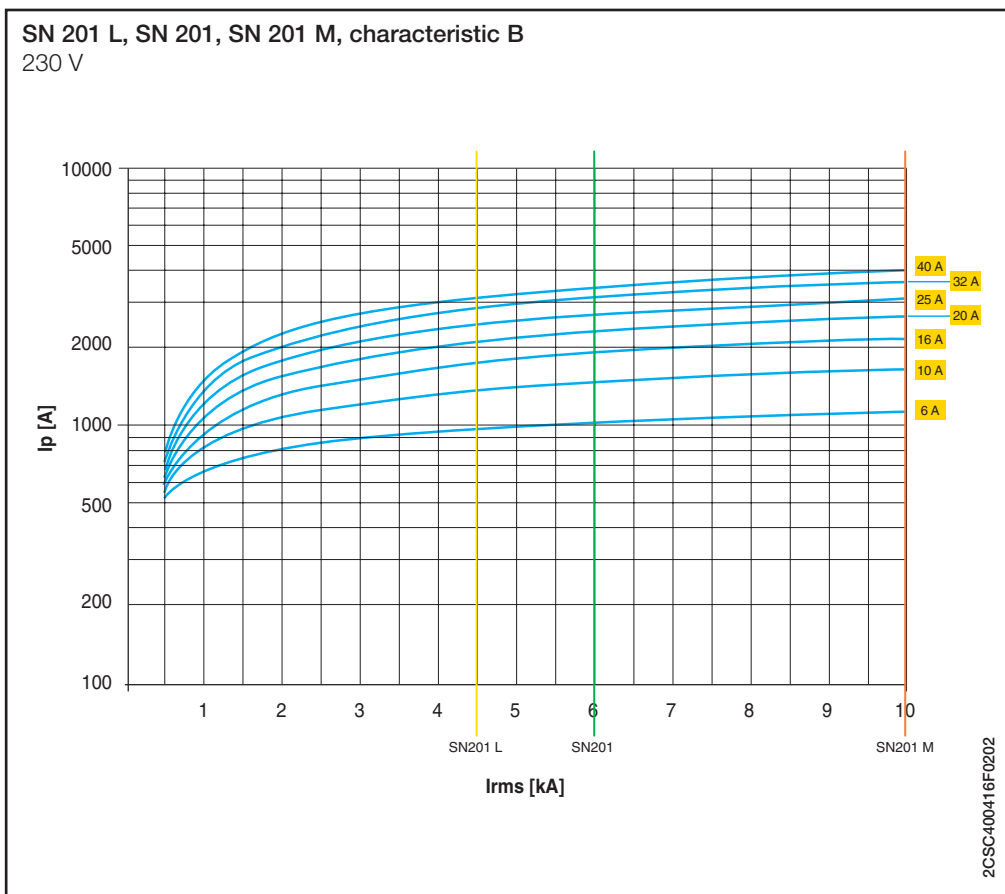
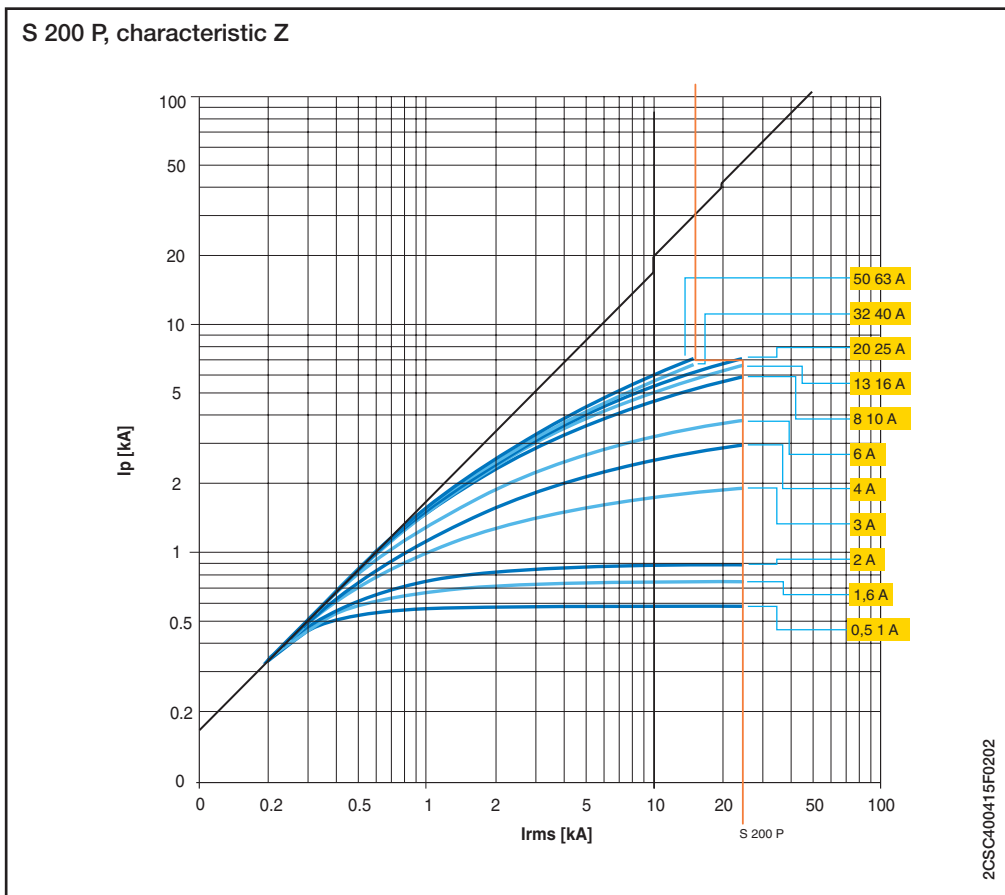

SN 201 L, SN 201, SN 201 M, characteristic C
230 V

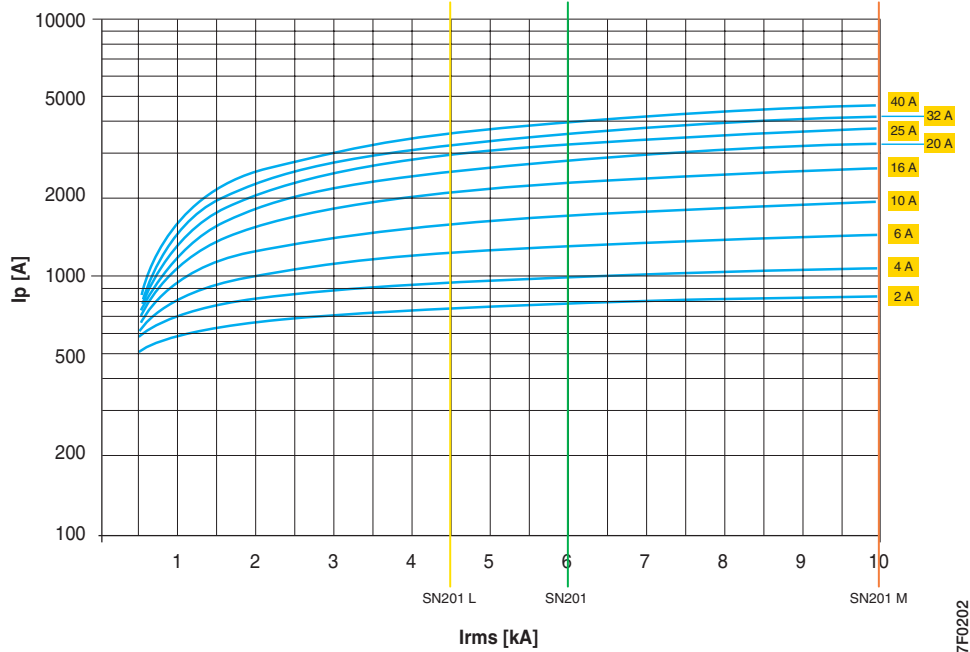

2CSC400417F0202

SN 201, characteristic D
230 V

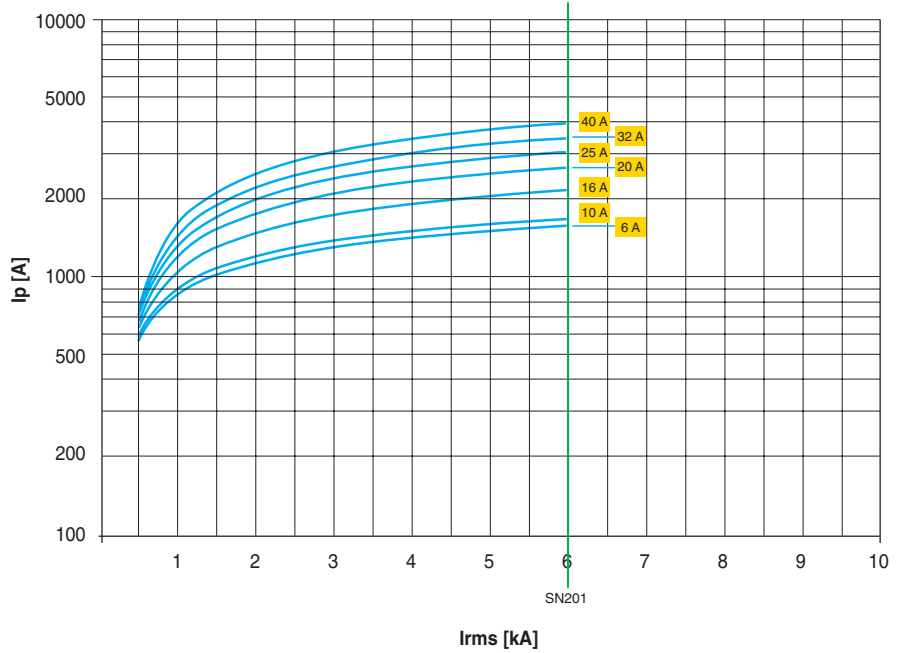

2CSC400418F0202

S 280 80-100 A, characteristic B

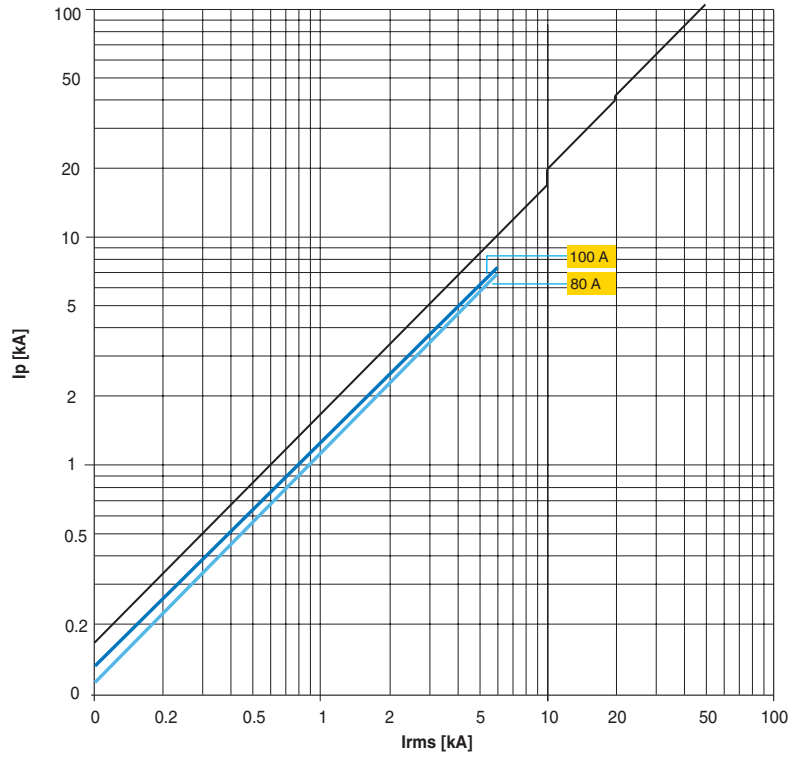

2CSC400419F0202

S 280 80-100 A, characteristic C

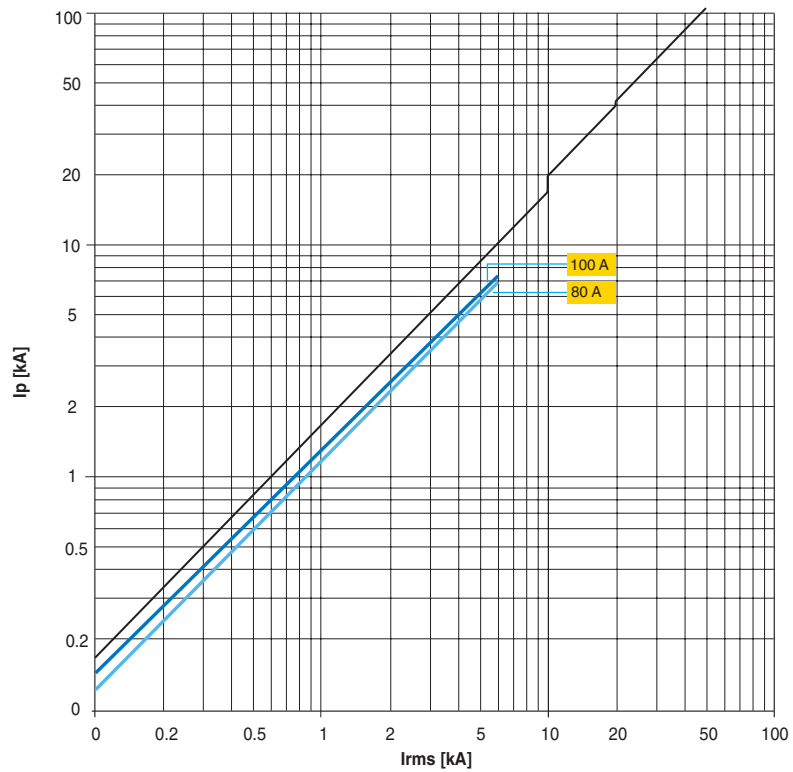

2CSC400420F0202

S 800 S characteristics B, C, K and D

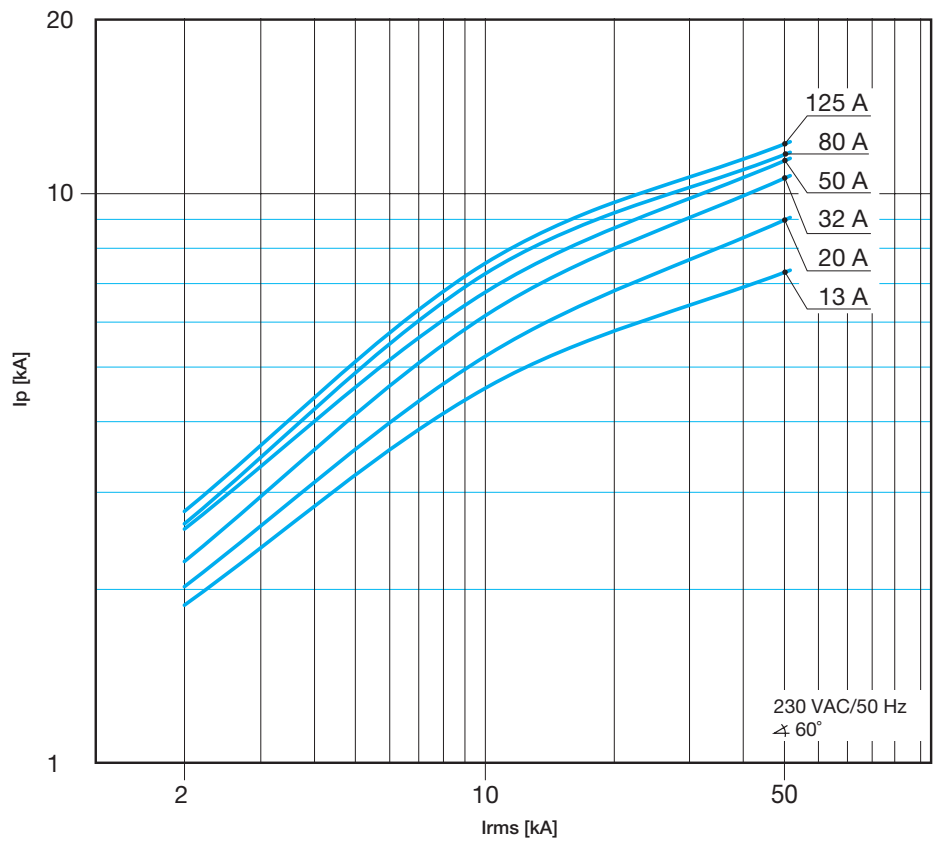

2CCC413032Z0001

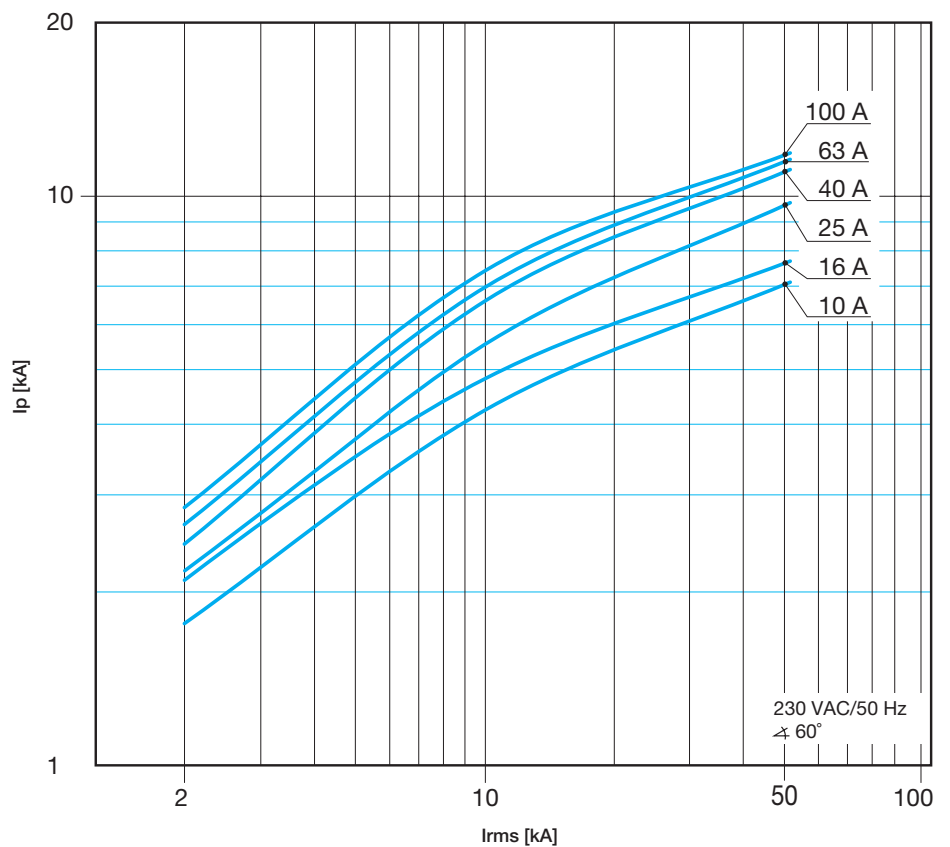

2CCC413033Z0001

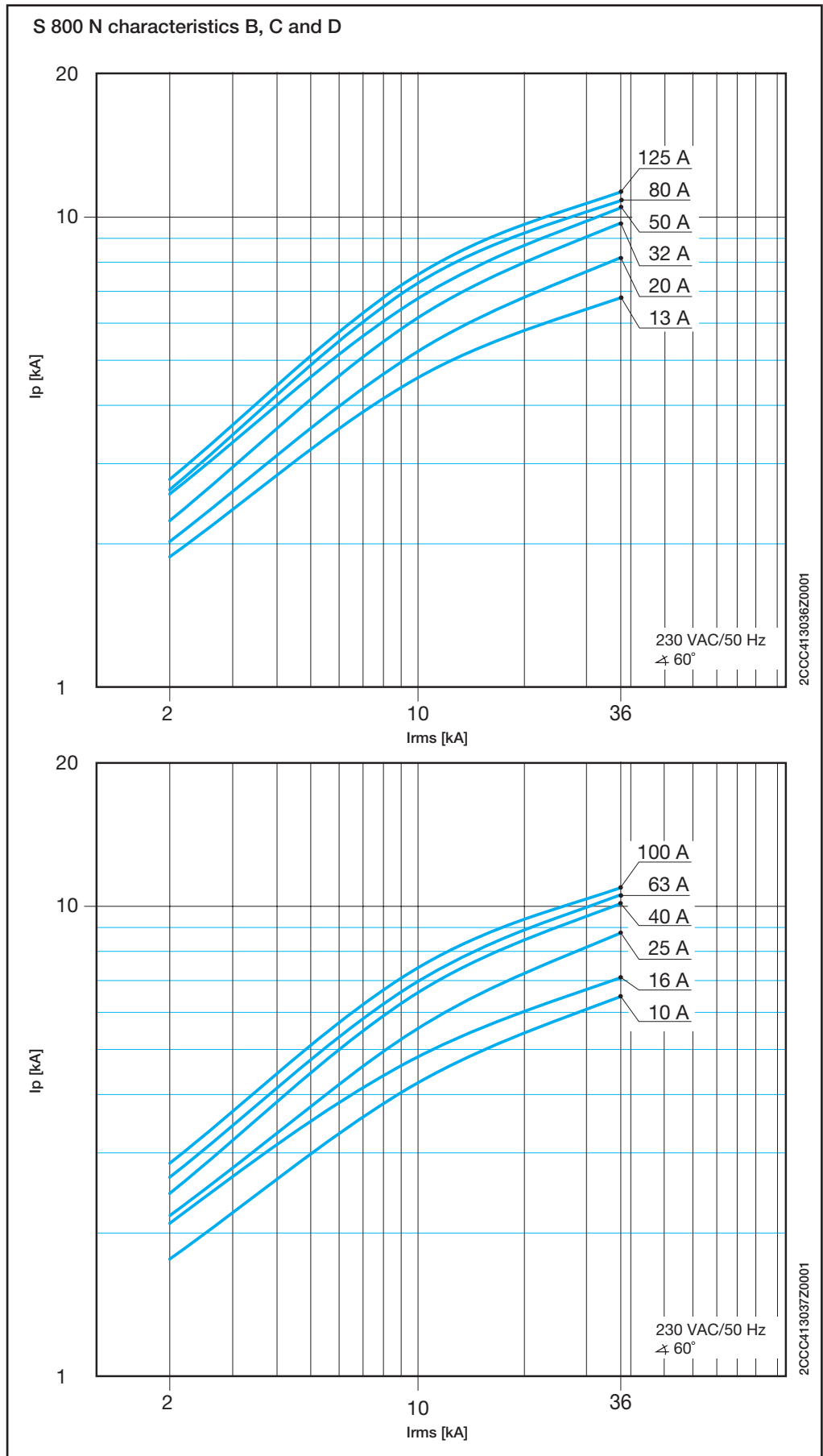

DS201 L - DS201 - DS201 M
DS202C - DS202C M characteristics B and C
230 V

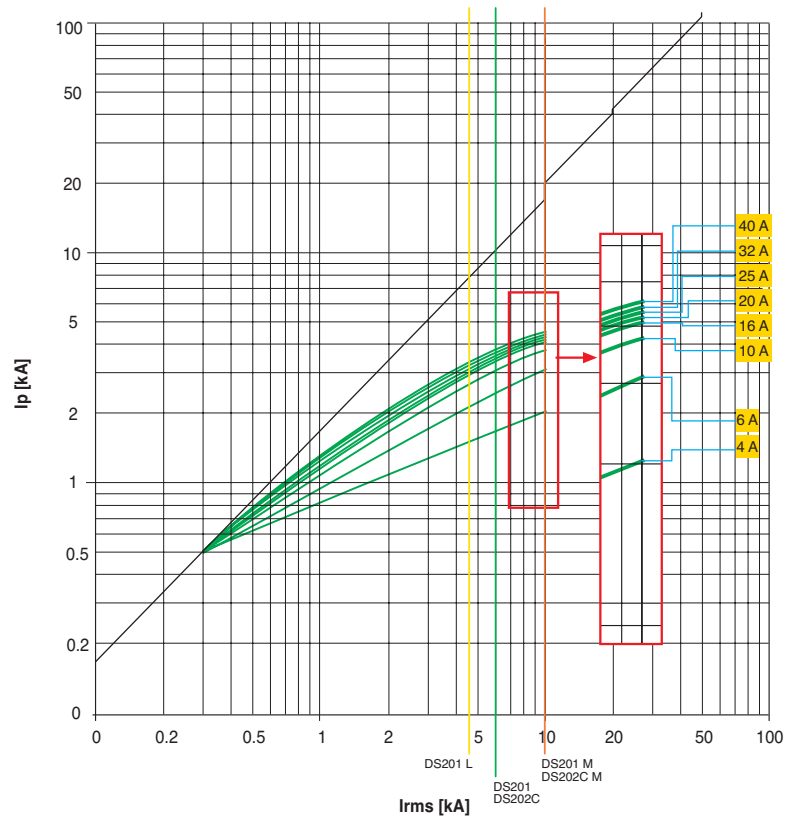

2CSC400421F0202

Back-up protection

The tables given provide the value (in kA, referring to the breaking capacity according to the IEC 60947-2 Standard) for which the back-up protection among the combination of selected circuit-breakers is verified. The tables cover the possible combinations between ABB SACE Tmax series of moulded-case circuit-breakers and those between the above-mentioned circuit-breakers and the ABB series of modular circuit-breakers.

The values indicated in the tables refer to the voltage:

- Vn of 230/240 V AC for coordination with modular SN 201 circuit-breakers
- Vn of 400/415 V AC for all the other coordinations.

Selective protection

The tables given provide the value (in kA, referring to the breaking capacity according to the IEC 60947-2 Standard) for which the selective protection is verified among the combination of selected circuit-breakers. The tables cover the possible combinations between ABB SACE Tmax series of moulded-case circuit-breakers, and the ABB series of modular circuit-breakers. The values in the table represent the maximum value obtainable of discrimination between supply side circuit-breaker and load side circuit-breaker referring to the voltage:

- Vn of 230/240 V AC for the SN 201 circuit-breakers and Vn of 400/415 V AC for the supply side circuit-breakers in the coordination between MCB with the modular SN 201 circuit-breakers (see picture).
- Vn of 400/415 V AC for all the other coordinations.

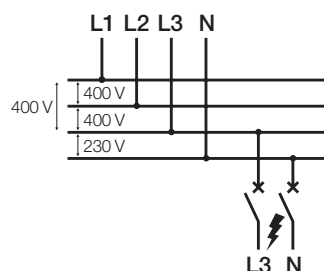

General prescriptions

- Function I of the electronic releases of the supply side circuit-breakers must be excluded (I_3 in OFF);
- The magnetic trip of thermomagnetic (TM) or magnetic only (M) circuit-breakers placed on the supply side must be $10 \times I_n$ and regulated to the maximum threshold;
- It is of prime importance to check that the settings made by the user for the electronic and thermomagnetic relays of circuit-breakers placed both on the load and supply side do not create intersections on the time-current curves.

Note

The following tables give the breaking capacities at 415 V AC for circuit-breakers SACE Tmax.

Tmax @ 415 V AC	
Version	Icu [kA]
B	16
C	25
N	36
S	50
H	70
L (T2)	85
L (T4, T5)	120
V	200

Caption

MCB = miniature circuit-breakers (SN 201, S 2, S 800)

MCCB = moulded-case circuit-breakers (Tmax)

For moulded-case or air circuit-breakers:

TM = thermomagnetic release

- TMD (Tmax)
- TMA (Tmax)

M = magnetic only release

- MF (Tmax)

- MA (Tmax)

EL = electronic release

- PR221DS - PR222DS (Tmax)

For miniature circuit-breakers:

B = trip characteristic ($I_m=3...5I_n$)

C = trip characteristic ($I_m=5...10I_n$)

D = trip characteristic ($I_m=10...20I_n$)

K = trip characteristic ($I_m=8...14I_n$)

Z = trip characteristic ($I_m=2...3I_n$)

For solutions not shown in these tables, please consult the website:

<http://bol.it.abb.com> or contact ABB SACE

System **pro M compact®** Technical details

Coordination tables: back-up

MCBs

MCB - MCB @240 V

Load s.	Char.	Icu [kA]	Supply s.	S200	S200M	S200P	S200P	S280	S290	S800S	25gL	40gL	50gL	63gL	80gL	100gL	
				B-C	B-C	B-C	B-C	B-C	C-D	B-C-D-K							
			In [A]	0,5...63	0,5...63	0,5...25	32...63	80...100	80...125	10...125							
SN201 L/DS201 L	B,C	6	2...40	20	25	40	25	15	15	50	35	25	20	15	10	10	
SN201/DS201/DS202C	B,C,D	10	2...40	20	25	40	25	15	15	50	35	25	20	15	10	10	
SN201 M/DS201 M/DS202C M	B,C	10	2...40	20	25	40	25	15	15	50	35	25	20	15	10	10	
S200	B,C,K,Z	20	0,5...63		25	40	25			50							
S200 M	B,C,D	25	0,5...63			40				50							
S200 P	B,C	40	0,5...25							50							
	D,K,Z	25	32...63							50							
S290	C,D,K	25	80...125														
S800	B,C	100	10...125														

MCCB @ 415 V - MCB/RCBO @ 240 V

Load S.	Char.	I _n [A]	Supply S. ¹	T1	T1	T1	T2	T3	T2	T3	T2	T2
			Version	B	C	N		S		H	L	
		I _{cu} [kA]		16	25	36		50		70	85	
SN201 L DS201 L	B, C	2..25	6	16	16	16	20	10	20	10	20	20
		32, 40		10	10	10	16		16		16	
SN201 DS201 DS202C	B, C, D, K	2..25	10	16	16	16	25	16	25	16	25	25
		32, 40		16	16	16	16		16		16	
SN201 M DS201 M DS202C M	B, C	2..25	10	16	16	16	25	16	25	16	25	25
		32, 40		16	16	16	16		16		16	

¹ Supply side circuit-breaker 4P (load side circuit branched between one phase and the neutral)

MCB - MCB @ 415 V

Load S.	Char.	I _{cu} [kA]	Supply S.	S200	S200M	S200P		S280	S290	S800N	S800S
			I _n [A]	B-C	B-C	B-C		B-C	C	B-C-D	B-C-D-K
				10	15	25	15	6	15	36	50
S200	B,C,K,Z	10	0.5..63	15	25	15	80, 100	80..125	25..125	25..125	50
S200M	B,C	15	0.5..63	25						36	50
S200P	B,C, D,K,Z	25	0.5..25							36	50
		15	32..63							36	50
S280	B,C	6	80, 100								
S290	C,D	15	80..125								
S800N	B,C,D	36	10..125								
S800S	B,C,D,K	50	10..125								

MCCB - MCB @ 415 V

Load S.	Char.	I _n [A]	Supply S.	T1	T1	T1	T2	T3	T4	T2	T3	T4	T2	T4	T2	T4	T4	
			Version	B	C	N			S			H		L	L	V		
			I _{cu} [kA]	16	25	36			50			70		85	120	200		
S200	B,C,K,Z	0.5..10	10	16	25	30	36	36	36	36	40	40	40	40	40	40	40	40
		13..63						16			16							
S200M	B,C	0.5..10	15	16	25	30	36	36	36	50	40	40	70	40	85	40	40	40
		13..63						25			60		60					
S200P	B,C, D,K,Z	0.5..10	25	16	25	30	36	36	36	50	40	40	70	40	85	40	40	40
		13..25						30			30		60		60			
		32..63						25			25		60		60			
S280	B,C	80, 100	6	16	16	16	36	16	30	36	16	30	36	30	36	30	30	30
S290	C,D	80..125	20 (15*)	16	25	30	36	30	30	50	30	30	70	30	85	30	30	30
S800N	B,C,D	10..125	36										70	70	85	120	200	
S800S	B,C,D,K	10..125	50										70	70	85	120	200	

* only for D characteristic

Fuse 125 A gG, gL - RCBO @ 230V

Load S.	Char.	I _n [A]	Supply S.	[kA]	Fuse 125 A gG, gL
DS 271	B,C	6-40		10	15

Fuse gG, gL - MCB S 200, S 200 M

240 V	Supply s.		Fuse gG, gL
	Load s.	Characteristic	In [A]
S200 S200 M	B	6	63
		10...20	100
		25...32	100
		40	125
		50...63	160
S200 S200 M	C	3...4	20
		6	40
		8	63
		10...20	100
		25...32	100
		40	125
		50...63	160
S200	K	3	20
		4	25
		6...10	63
		16...20	80
		25...32	100
		40	125
		50...63	160
S200	Z	3...4	20
		6	35
		8	40
		10...16	63
		20...25	80
		32...40	100
		50...63	125

This table shows coordination between an MCB and the upstream fuse maximum current value. Combination of the two protections allows the breaking capacity to be elevated up to that of the combined fuse.
I.e. downstream MCB breaker S 202 C16, upstream fuse with In up to 100 A (breaking capacity: 100 kA). MCB breaker protection up to 100 kA.

Selective protection

Selectivity between SN 201 and S 200 upstream and downstream modular circuit-breakers
In the case, selectivity is amperometric and so the selectivity limit is given simply by the magnetic threshold of the upstream breaker, which is fixed. The selectivity value is obtained if a minimum ratio of 1.6 ($I_n \text{ upstream} / I_n \text{ downstream} > 1.6$) is observed between the rated currents of the two breakers.

Example

Upstream circuit-breaker	S 200 P, curve D 50 A
Downstream circuit-breaker	SN 201 L, curve B 10 A
Selectivity limit	10 I_n =500 A

MCB - SN201 @ 230/240 V

Load S. ¹	Char.	Supply S. ²		S290				S800 N-S									
		I_{cu} [kA]	I_n [A]	C		D		B									
				80	100	125	80	100	36-50								
SN201 L	B, C	6	2	2	T	T	T	T	T		0.43 ³	0.6	1.3	4	T	T	T
			4	5	T	T	T	T			0.45	0.8	1.5	2.5	4	T	
			6	4.5	5	T	5.5	T				0.6	1.2	1.6	2.6	3.8	
			10	4	4.5	5	5	5				0.5	1.1	1.4	2	3	
			16	2.5	3.5	3.5	4	4.5					0.8	1.2	1.7	2.5	
			20	1.5	2.5	2.5	3	4.5						1	1.5	2.1	
			25	0.5	0.5	1.5	2	4							1.3	1.8	
			32	0.5	0.5	0.5	1.5	3.5							1.1	1.7	
			40	0.5	0.5	0.5	1.5	3.5								1.6	
SN201	B, C, D	10	2	6	8	9	7	8		0.43 ³	0.6	1.3	4	9	T	T	
			4	5	6	7.5	6	7			0.45	0.8	1.5	2.5	4	7.3	
			6	4.5	5	6	5.5	6				0.6	1.2	1.6	2.6	3.8	
			10	4	4.5	5	5	5				0.5	1.1	1.4	2	3	
			16	2.5	3.5	3.5	4	4.5					0.8	1.2	1.7	2.5	
			20	1.5	2.5	2.5	3	4.5						1	1.5	2.1	
			25	0.5	0.5	1.5	2	4							1.3	1.8	
			32	0.5	0.5	0.5	1.5	3.5							1.1	1.7	
			40	0.5	0.5	0.5	1.5	3.5								1.6	
SN201 M	B, C	10	2	6	8	9	7	8		0.43 ³	0.6	1.3	4	9	T	T	
			4	5	6	7.5	6	7			0.45	0.8	1.5	2.5	4	7.3	
			6	4.5	5	6	5.5	6				0.6	1.2	1.6	2.6	3.8	
			10	4	4.5	5	5	5				0.5	1.1	1.4	2	3	
			16	2.5	3.5	3.5	4	4.5					0.8	1.2	1.7	2.5	
			20	1.5	2.5	2.5	3	4.5						1	1.5	2.1	
			25	0.5	0.5	1.5	2	4							1.3	1.8	
			32	0.5	0.5	0.5	1.5	3.5							1.1	1.7	
			40	0.5	0.5	0.5	1.5	3.5								1.6	

¹ Load side circuit-breaker 1P+N (230/240 V)

² For networks with 230/240 V AC two-pole circuit-breaker (phase + neutral)

for networks at 400/415 V AC four-pole circuit-breaker (load side circuit branched between one phase and the neutral)

³ Only for curve B

S800 N-S									S800 N-S							
C									D							
36-50									36-50							
25	32	40	50	63	80	100	125		25	32	40	50	63	80	100	125
0.4 ³	0.55	1.2	3	T	T	T	T		1.3	4.1	T	T	T	T	T	T
	0.43	0.75	1.3	2.1	3.9	T	T		0.8	1.6	3	5.4	T	T	T	T
		0.55	1.1	1.5	2.5	3.6	5.5		0.6	1.3	2	3.2	3.9	T	T	T
		0.45	1	1.3	1.9	2.8	4.2		0.5	1.2	1.65	2.6	3.1	T	T	T
			0.75	1.1	1.6	2.3	3.6			0.9	1.4	1.8	2.6	5	T	T
				0.9	1.4	1.9	3.3				1.3	1.6	2.2	4.2	5.4	T
					1.2	1.6	2.7					1.5	1.9	3.5	4.5	T
					1	1.5	2.5						1.8	2.8	4.2	5.5
						1.4	2.1						1.7	2.7	4	5
0.4 ³	0.55	1.2	3	6.6	T	T	T		1.3	4.1	T	T	T	T	T	T
	0.43	0.75	1.3	2.1	3.9	6.6	T		0.8	1.6	3	5.4	7.6	T	T	T
		0.55	1.1	1.5	2.5	3.6	5.5		0.6	1.3	2	3.2	3.9	8	T	T
		0.45	1	1.3	1.9	2.8	4.2		0.5	1.2	1.65	2.6	3.1	6.2	8.6	T
			0.75	1.1	1.6	2.3	3.6			0.9	1.4	1.8	2.6	5	6.3	8.8
				0.9	1.4	1.9	3.3				1.3	1.6	2.2	4.2	5.4	7.6
					1.2	1.6	2.7					1.5	1.9	3.5	4.5	6.6
					1	1.5	2.5						1.8	2.8	4.2	5.5
						1.4	2.1						1.7	2.7	4	5
0.4 ³	0.55	1.2	3	6.6	T	T	T		1.3	4.1	T	T	T	T	T	T
	0.43	0.75	1.3	2.1	3.9	6.6	T		0.8	1.6	3	5.4	7.6	T	T	T
		0.55	1.1	1.5	2.5	3.6	5.5		0.6	1.3	2	3.2	3.9	8	T	T
		0.45	1	1.3	1.9	2.8	4.2		0.5	1.2	1.65	2.6	3.1	6.2	8.6	T
			0.75	1.1	1.6	2.3	3.6			0.9	1.4	1.8	2.6	5	6.3	8.8
				0.9	1.4	1.9	3.3				1.3	1.6	2.2	4.2	5.4	7.6
					1.2	1.6	2.7					1.5	1.9	3.5	4.5	6.6
					1	1.5	2.5						1.8	2.8	4.2	5.5
						1.4	2.1						1.7	2.7	4	5

Fuse - SN201 @ 230/240 V

	Im	Icu [kA]	In [A]								
			16	25	32	40	50	63	80	100	125
SN201 L	B-C	6	2	1.5	2.5	T	T	T	T	T	T
		6	4	1	2	4.5	T	T	T	T	T
		6	6	1	1.5	4	4.5	T	T	T	T
		6	10		1.2	3.5	4	T	T	T	T
		6	16		1	3	3.5	5	T	T	T
		6	20		1	3	3.5	5	T	T	T
		6	25		1	2	3	4.5	T	T	T
		6	32		1	2	3	4.5	5	T	T
SN201	B-C-D	10	2	1.5	2.5	5	T	T	T	T	T
		10	4	1	2	4.5	5	T	T	T	T
		10	6	1	1.5	4	4.5	7	T	T	T
		10	10		1.2	3.5	4	6	T	T	T
		10	16		1	3	3.5	5	T	T	T
		10	20		1	3	3.5	5	8	T	T
		10	25		1	2	3	4.5	6.5	T	T
		10	32		1	2	3	4.5	5	8	T
SN201 M	B-C	10	2	1.5	2.5	5	7	T	T	T	T
		10	4	1	2	4.5	5	8	T	T	T
		10	6	1	1.5	4	4.5	7	T	T	T
		10	10		1.2	3.5	4	6	T	T	T
		10	16		1	3	3.5	5	9	T	T
		10	20		1	3	3.5	5	8	T	T
		10	25		1	2	3	4.5	6.5	9	T
		10	32		1	2	3	4.5	5	8	T
		10	40			1.5	2.5	4	5	6.5	9

System **Technical details**
pro M compact® Coordination tables:
 selectivity

MCB S700 - SN201 @ 230/240 V

	Im			E	E	E	E	E	E	E	E	
		Icu [kA]	In [A]	25	25	25	25	25	25	25	25	
				20	25	35	40	50	63	80	100	
SN201 L	B-C	6	2	T	T	T	T	T	T	T	T	T
		6	4	T	T	T	T	T	T	T	T	T
		6	6	T	T	T	T	T	T	T	T	T
		6	10	T	T	T	T	T	T	T	T	T
		6	16		T	T	T	T	T	T	T	T
		6	20			T	T	T	T	T	T	T
		6	25			T	T	T	T	T	T	T
		6	32					T	T	T	T	T
		6	40							T	T	T
SN201	B-C-D	10	2	T	T	T	T	T	T	T	T	T
		10	4	T	T	T	T	T	T	T	T	T
		10	6	T	T	T	T	T	T	T	T	T
		10	10	T	T	T	T	T	T	T	T	T
		10	16		T	T	T	T	T	T	T	T
		10	20			T	T	T	T	T	T	T
		10	25			T	T	T	T	T	T	T
		10	32					T	T	T	T	T
		10	40							T	T	T
SN201 M	B-C	10	2	T	T	T	T	T	T	T	T	T
		10	4	T	T	T	T	T	T	T	T	T
		10	6	T	T	T	T	T	T	T	T	T
		10	10	T	T	T	T	T	T	T	T	T
		10	16		T	T	T	T	T	T	T	T
		10	20			T	T	T	T	T	T	T
		10	25			T	T	T	T	T	T	T
		10	32					T	T	T	T	T
		10	40							T	T	T

System **pro M compact®** Technical details

Coordination tables: selectivity

MCBs

MCCB @ 415 V 4P - SN201/DS201/DS202C @ 240 V

			Supply S.	T1																		
			Version	B, C, N																		
			Release	TMD																		
			I_n [A]	160																		
Load S.	Char.	I_{cu} [kA]	I_n [A]	16	20	25	32	40	50	63	80	100	125	160 ²	160	16	20	25	32	40	50	
SN201 L DS201 L	B, C	6	≤4	T	T	T	T	T	T	T	T	T	T	T	T	T	T	T	T	T	T	
	B, C		6	T	T	T	T	T	T	T	T	T	T	T	T	T	T	T	T	T	T	
	B, C		10			3	3	3	4.5	T	T	T	T	T	T			3 ¹	3	3	3	4.5
	B, C		16					3	4.5	5	T	T	T	T	T				3 ¹	3		4.5
	B, C		20						3	5	T	T	T	T	T				3 ¹			3
	B, C		25							5	T	T	T	T	T							3 ¹
	B, C		32								T	T	T	T	T							3 ¹
	B, C		40									T	T	T	T							
SN201 DS201 DS202C	B, C, D, K	10	≤4	T	T	T	T	T	T	T	T	T	T	T	T	T	T	T	T	T	T	
	B, C, D, K		6	6	6	6	6	6	6	T	T	T	T	T	T	T	T	T	T	T	T	
	B, C, D, K		8			3	3	3	4.5	7.5	8.5	T	T	T	T			3 ¹	3	3	3	4.5
	B, C, D, K		10			3	3	3	4.5	7.5	8.5	T	T	T	T			3 ¹	3	3	3	4.5
	B, C, D, K		13					3	4.5	5	7.5	T	T	T	T				3 ¹	3		4.5
	B, C, D, K		16					3	4.5	5	7.5	T	T	T	T				3 ¹	3		4.5
	B, C, D, K		20						3	5	6	T	T	T	T				3 ¹			3
	B, C, D, K		25							5	6	T	T	T	T							3 ¹
	B, C, D, K		32								6	7.5	T	T	T							3 ¹
	B, C, D, K		40									7.5	T	T	T							
SN201 M DS201 M DS202C M	B, C	10	≤4	T	T	T	T	T	T	T	T	T	T	T	T	T	T	T	T	T	T	
	B, C		6	6	6	6	6	6	6	12	T	T	T	T	T	T	T	T	T	T	T	
	B, C		10			3	3	3	4.5	7.5	8.5	T	T	T	T			3 ¹	3	3	3	4.5
	B, C		13					3	4.5	5	7.5	T	T	T	T				3 ¹	3		4.5
	B, C		16					3	4.5	5	7.5	T	T	T	T				3 ¹	3		4.5
	B, C		20						3	5	6	T	T	T	T				3 ¹			3
	B, C		25							5	6	T	T	T	T							3 ¹
	B, C		32								6	7.5	T	T	T							3 ¹
	B, C		40									7.5	T	T	T							

Supply side circuit-breaker 4P (load side circuit branched between one phase and the neutral)

Load side circuit-breaker 1P+N (230/240 V)

¹ Value valid for magnetic only supply side circuit-breaker

² Neutral at 50%

T2													T3										
N, S, H, L													N, S										
TMD, MA								EL					TMD, MA										
160													250										
63	80	100	125 ²	125	160 ²	160	10	25	63	100	160	63	80	100	125 ²	125	160 ²	160	200 ²	200	250 ²	250	
T	T	T	T	T	T	T	T	T	T	T	T	T	T	T	T	T	T	T	T	T	T	T	
T	T	T	T	T	T	T		T	T	T	T	T	T	T	T	T	T	T	T	T	T	T	
T	T	T	T	T	T	T		T	T	T	T	T	T	T	T	T	T	T	T	T	T	T	
5	T	T	T	T	T	T			T	T	T	5	T	T	T	T	T	T	T	T	T	T	
5	T	T	T	T	T	T			T	T	T	5	T	T	T	T	T	T	T	T	T	T	
5	T	T	T	T	T	T			T	T	T	5	T	T	T	T	T	T	T	T	T	T	
	T	T	T	T	T	T			T	T	T		T	T	T	T	T	T	T	T	T	T	
	T	T		T	T	T				T	T		T	T		T	T	T	T	T	T	T	
T	T	T	T	T	T	T	T	T	T	T	T	T	T	T	T	T	T	T	T	T	T	T	
T	T	T	T	T	T	T		T	T	T	T	T	T	T	T	T	T	T	T	T	T	T	
7.5	8.5	T	T	T	T	T		T	T	T	T	7.5	8.5	T	T	T	T	T	T	T	T	T	
7.5	8.5	T	T	T	T	T		T	T	T	T	7.5	8.5	T	T	T	T	T	T	T	T	T	
5	7.5	T	7.5	T	T	T			T	T	T	5	7.5	T	7.5	T	T	T	T	T	T	T	
5	7.5	T	7.5	T	T	T			T	T	T	5	7.5	T	7.5	T	T	T	T	T	T	T	
5	6	T	6	T	T	T			T	T	T	5	6	T	6	T	T	T	T	T	T	T	
5	6	T	6	T	T	T			T	T	T	5	6	T	6	T	T	T	T	T	T	T	
	6	7.5	6	T	T	T			T	T	T		6	7.5	6	T	T	T	T	T	T	T	
	6 ¹	7.5	6	T	T	T				T	T		6 ¹	7.5		T	T	T	T	T	T	T	
T	T	T	T	T	T	T	T	T	T	T	T	T	T	T	T	T	T	T	T	T	T	T	
T	T	T	T	T	T	T		T	T	T	T	T	T	T	T	T	T	T	T	T	T	T	
7.5	8.5	T	T	T	T	T		T	T	T	T	7.5	8.5	T	T	T	T	T	T	T	T	T	
5	7.5	T	7.5	T	T	T			T	T	T	5	7.5	T	7.5	T	T	T	T	T	T	T	
5	7.5	T	7.5	T	T	T			T	T	T	5	7.5	T	7.5	T	T	T	T	T	T	T	
5	6	T	6	T	T	T			T	T	T	5	6	T	6	T	T	T	T	T	T	T	
5	6	T	6	T	T	T			T	T	T	5	6	T	6	T	T	T	T	T	T	T	
	6	7.5	6	T	T	T			T	T	T		6	7.5	6	T	T	T	T	T	T	T	
	6 ¹	7.5	6	T	T	T				T	T		6 ¹	7.5		T	T	T	T	T	T	T	

MCB S290 - S200 @ 400/415 V

400/415 V		Supply s.		S290				
Load s.	Char.	lcu [kA]	In [A]	D				
				15				
				80	100			
S200	C	10	≤ 2	T	T			
			3	T	T			
			4	T	T			
			6	T	T			
	B-C	10	8	T	T			
			10	5	8			
			13	4.5	7			
			16	4.5	7			
			20	3.5	5			
			25	3.5	5			
			32		4.5			
			40					
			50					
			63					
			D	10	≤ 2	T	T	
					3	T	T	
	4	T			T			
	6	T			T			
	8	T			T			
	10	5			8			
	13	3			5			
	16	3			5			
	20	3			5			
	25				4			
	32							
	40							
	50							
	63							

400/415 V		Supply s.		S290		
Load s.	Char.	lcu [kA]	In [A]	D		
				15		
				80	100	
S200	K	10	≤ 2	T	T	
			3	T	T	
			4	T	T	
			6	T	T	
			8	T	T	
			10	5	8	
			16	3	5	
			20	3	5	
			25		4	
			32			
			40			
			50			
	63					
	Z	10	≤ 2	T	T	
			3	T	T	
			4	T	T	
			6	T	T	
			8	T	T	
			10	5	8	
			16	4.5	7	
			20	3.5	5	
			25	3.5	5	
			32	3	4.5	
			40	3	4.5	
			50		3	
			63			

System pro M compact®

Technical details

Coordination tables: selectivity

MCBs

MCB S290 - S200 M @ 400/415 V

400/415 V	Supply s.		S290				
	Char.		D				
Load s.	S200 M	Icu [kA]	15				
			In [A]	80	100		
400/415 V	C	15	≤ 2	T	T		
			3	T	T		
			4	T	T		
			B-C	15	6	10.5	T
					8	10.5	T
					10	5	8
					13	4.5	7
					16	4.5	7
					20	3.5	5
					25	3.5	5
					32		4.5
			40				
	50						
	63						
	D	15	≤ 2	T	T		
			3	T	T		
			4	T	T		
			6	10.5	T		
			8	10.5	T		
			10	5	8		
			16	3	5		
			20	3	5		
			25		4		
			32				
			40				
			50				
			63				
			K	15	≤ 2	T	T
					3	T	T
					4	T	T
					6	10.5	T
					8	10.5	T
	10	5			8		
16	3	5					
20	3	5					
25		4					
32							
40							
50							
63							

MCB S290 - S200 P @ 400/415 V

400/415 V	Supply s.		S290						
	Char.		D						
Load s.	S200 P	Icu [kA]	15						
			In [A]	80	100				
400/415 V	B-C	25	≤ 2	T	T				
			3	T	T				
			4	T	T				
			6	10.5	T				
			8	10.5	T				
			10	5	8				
			13	4.5	7				
			16	4.5	7				
			20	3.5	5				
			25	3.5	5				
			15	15	32		4.5		
					40				
					50				
					63				
					D	25	≤ 2	T	T
							3	T	T
			4	T			T		
			6	10.5			T		
	8	10.5	T						
	10	5	8						
	13	3	5						
	16	3	5						
	20	3	5						
	25		4						
	15	15	32						
			40						
			50						
			63						
			K	25	≤ 2	T	T		
					3	T	T		
	4	T			T				
	6	10.5			T				
	8	10.5			T				
10	5	8							
13	3	5							
16	3	5							
20	3	5							
25		4							
15	15	32				4.5			
		40				4.5			
		50				3			
		63							
		Z			25	≤ 2	T	T	
						3	T	T	
4	T					T			
6	10.5					T			
8	10.5		T						
10	5		8						
13	4.5		7						
16	3.5		5						
20	3.5		5						
25		4							
15	15	32		4.5					
		40		4.5					
		50		3					
		63							

System pro M compact®

Technical details

Coordination tables: selectivity

L.	Char.	I _{cu} [kA]	E.		S800S						
			I _n [A]	D							
				25	32	40	50	63	80	100	125
S200	B	10	6	0.5	1	1.2	2	2.8	T	T	T
			10	0.4	0.6	0.8	1.1	1.4	2.8	3.9	T
			13	0.4	0.6	0.8	1.1	1.4	2.5	3.3	T
			16		0.6	0.8	1.1	1.4	2.5	3.3	5.6
			20			0.8	1.1	1.3	2.3	3	4.7
			25			0.8	1.1	1.3	2.3	3	4.7
			32				0.9	1.1	1.9	2.4	3.7
			40					1.1	1.9	2.4	3.7
			50						1.5	1.9	2.3
			63							1.7	2.3

L.	Char.	I _{cu} [kA]	E.		S800S							
			I _n [A]	D								
				25	32	40	50	63	80	100	125	
S200	C	10	0.5	T	T	T	T	T	T	T	T	T
			1	T	T	T	T	T	T	T	T	T
			1.6	T	T	T	T	T	T	T	T	T
			2	T	T	T	T	T	T	T	T	T
			3	0.7	2.2	4.4	T	T	T	T	T	
			4	0.7	1.3	2.2	4.4	T	T	T	T	
			6	0.5	1	1.2	2	2.8	T	T	T	
			8	0.4	0.6	0.8	1.1	1.4	2.8	3.9	T	
			10	0.4	0.6	0.8	1.1	1.4	2.8	3.9	T	
			13	0.4	0.6	0.8	1.1	1.4	2.5	3.3	5.6	
			16		0.6	0.8	1.1	1.4	2.5	3.3	5.6	
			20			0.8	1.1	1.3	2.3	3	4.7	
			25			0.8	1.1	1.3	2.3	3	4.7	
			32				0.9	1.1	1.9	2.4	3.7	
			40					1.1	1.9	2.4	3.7	
			50						1.5	1.9	2.3	
			63							1.7	2.3	

L.	Char.	I _{cu} [kA]	E.		S800S							
			I _n [A]	D								
				25	32	40	50	63	80	100	125	
S200	D	10	0.5	T	T	T	T	T	T	T	T	T
			1	T	T	T	T	T	T	T	T	T
			1.6	T	T	T	T	T	T	T	T	T
			2	2.3	T	T	T	T	T	T	T	T
			3	0.7	1.3	4.4	T	T	T	T	T	
			4	0.7	1	2.2	4.4	T	T	T	T	
			6	0.6	0.8	1.5	2.5	3.6	T	T	T	
			8	0.5	0.7	1.1	1.5	2	4	5.5	T	
			10	0.5	0.7	1.1	1.5	2	4	5.5	T	
			13		0.6	0.9	1.2	1.5	2.6	3.4	5.2	
			16			0.9	1.2	1.5	2.6	3.4	5.2	
			20				0.9	1.1	1.8	2.2	3.2	
			25					1.1	1.8	2.2	3.2	
			32						1.7	2	2.9	
			40							1.9	2.6	
			50								2.2	
			63									

L.	Char.	I _{cu} [kA]	E.		S800S						
			I _n [A]	D							
				25	32	40	50	63	80	100	125
S200	K	10	0.5	T	T	T	T	T	T	T	T
			1	T	T	T	T	T	T	T	T
			1.6	T	T	T	T	T	T	T	T
			2	2.3	T	T	T	T	T	T	T
			3	0.7	1.3	4.4	T	T	T	T	T
			4	0.7	1	2.2	4.4	T	T	T	T
			6	0.6	0.8	1.5	2.5	3.6	T	T	T
			8	0.5	0.7	1.1	1.5	2	4	5.5	T
			10	0.5	0.7	1.1	1.5	2	4	5.5	T
			13		0.6	0.9	1.2	1.5	2.6	3.4	5.2
			16			0.9	1.2	1.5	2.6	3.4	5.2
			20				0.9	1.1	1.8	2.2	3.2
			25					1.1	1.8	2.2	3.2
			32						1.7	2	2.9
			40							1.9	2.6
			50								2.2
			63								

E. = feed side L. = load side
 T = Total selectivity up to breaking capacity of the switch on load side
 Selectivity limit values indicated in kA

System pro M compact®

Technical details

Coordination tables: selectivity

L.	Char.	I _{cu} [kA]	E.		S800S						
			I _n [A]	D							
				25	32	40	50	63	80	100	125
S200M	B	15	6	0.5	1	1.2	2	2.8	T	T	T
			10	0.4	0.6	0.8	1.1	1.4	2.8	3.9	7.4
			13	0.4	0.6	0.8	1.1	1.4	2.5	3.3	5.6
			16		0.6	0.8	1.1	1.4	2.5	3.3	5.6
			20			0.8	1.1	1.3	2.3	3	4.7
			25			0.8	1.1	1.3	2.3	3	4.7
			32				0.9	1.1	1.9	2.4	3.7
			40					1.1	1.9	2.4	3.7
			50						1.5	1.9	2.3
			63							1.7	2.3

L.	Char.	I _{cu} [kA]	E.		S800S							
			I _n [A]	D								
				25	32	40	50	63	80	100	125	
S200M	C	15	0.5	T	T	T	T	T	T	T	T	T
			1	T	T	T	T	T	T	T	T	T
			1.6	T	T	T	T	T	T	T	T	T
			2	T	T	T	T	T	T	T	T	T
			3	0.7	2.2	4.4	T	T	T	T	T	
			4	0.7	1.3	2.2	4.4	7.7	T	T	T	
			6	0.5	1	1.2	2	2.8	9.9	T	T	
			8	0.4	0.6	0.8	1.1	1.4	2.8	3.9	7.4	
			10	0.4	0.6	0.8	1.1	1.4	2.8	3.9	7.4	
			13	0.4	0.6	0.8	1.1	1.4	2.5	3.3	5.6	
			16		0.6	0.8	1.1	1.4	2.5	3.3	5.6	
			20			0.8	1.1	1.3	2.3	3	4.7	
			25			0.8	1.1	1.3	2.3	3	4.7	
			32				0.9	1.1	1.9	2.4	3.7	
			40					1.1	1.9	2.4	3.7	
			50						1.5	1.9	2.3	
			63							1.7	2.3	

L.	Char.	I _{cu} [kA]	E.		S800S						
			I _n [A]	D							
				25	32	40	50	63	80	100	125
S200M	D	15	0.5	T	T	T	T	T	T	T	T
			1	T	T	T	T	T	T	T	T
			1.6	T	T	T	T	T	T	T	T
			2	2.3	T	T	T	T	T	T	T
			3	0.7	1.3	4.4	T	T	T	T	T
			4	0.7	1	2.2	4.4	7.7	T	T	T
			6	0.6	0.8	1.5	2.5	3.6	T	T	T
			8	0.5	0.7	1.1	1.5	2	4	5.5	T
			10	0.5	0.7	1.1	1.5	2	4	5.5	T
			13		0.6	0.9	1.2	1.5	2.6	3.4	5.2
			16			0.9	1.2	1.5	2.6	3.4	5.2
			20				0.9	1.1	1.8	2.2	3.2
			25					1.1	1.8	2.2	3.2
			32						1.7	2	2.9
			40							1.9	2.6
			50								2.2
			63								

L.	Char.	I _{cu} [kA]	E.		S800S						
			I _n [A]	D							
				25	32	40	50	63	80	100	125
S200M	K	15	0.5	T	T	T	T	T	T	T	T
			1	T	T	T	T	T	T	T	T
			1.6	T	T	T	T	T	T	T	T
			2	2.3	T	T	T	T	T	T	T
			3	0.7	1.3	4.4	T	T	T	T	T
			4	0.7	1	2.2	4.4	7.7	T	T	T
			6	0.6	0.8	1.5	2.5	3.6	T	T	T
			8	0.5	0.7	1.1	1.5	2	4	5.5	T
			10	0.5	0.7	1.1	1.5	2	4	5.5	T
			13		0.6	0.9	1.2	1.5	2.6	3.4	5.2
			16			0.9	1.2	1.5	2.6	3.4	5.2
			20				0.9	1.1	1.8	2.2	3.2
			25					1.1	1.8	2.2	3.2
			32						1.7	2	2.9
			40							1.9	2.6
			50								2.2
			63								

E. = feed side L. = load side
 T = Total selectivity up to breaking capacity of the switch on load side
 Selectivity limit values indicated in kA

System pro M compact®

Technical details

Coordination tables: selectivity

MCBs

S800S - S200 P @ 230/400 V

L.	Char.	I _{cu} [kA]	S800S									
			I _n [A]	B								125
				50								
			25	32	40	50	63	80	100	125		
S200P	B	25	6		0.4	0.5	0.7	1	1.5	2.6		
			10			0.4	0.6	0.7	1	1.4		
			13				0.5	0.7	0.9	1.3		
			16					0.7	0.9	1.3		
			20						0.9	1.3		
			25							0.9	1.3	
	15	32							0.8	1.1		
		40							0.8	1.1		
		50								1		
		63									0.9	

L.	Char.	I _{cu} [kA]	S800S									
			I _n [A]	C								125
				50								
			25	32	40	50	63	80	100	125		
S200P	B	25	6			0.4	0.5	0.7	1	1.5	2.6	
			10				0.4	0.6	0.7	1	1.4	
			13					0.5	0.7	0.9	1.3	
			16						0.7	0.9	1.3	
			20							0.9	1.3	
			25								0.9	1.3
	15	32								0.8	1.1	
		40								0.8	1.1	
		50									1	
		63									0.9	

L.	Char.	I _{cu} [kA]	S800S									
			I _n [A]	B								125
				50								
			25	32	40	50	63	80	100	125		
S200P	C	25	0.5	T	T	T	T	T	T	T	T	
			1	3.3	T	T	T	T	T	T	T	
			1.6	0.6	1.3	T	T	T	T	T	T	
			2	0.4	0.7	1.2	T	T	T	T	T	
			3		0.4	0.6	0.7	1.1	2.6	8.8	T	
			4		0.4	0.6	0.7	1	1.7	3.1	7	
			6			0.4	0.5	0.7	1	1.5	2.6	
			8				0.4	0.6	0.7	1	1.4	
			10				0.4	0.6	0.7	1	1.4	
			13					0.5	0.7	0.9	1.3	
			16						0.7	0.9	1.3	
			20							0.9	1.3	
			25								0.9	1.3
			32								0.8	1.1
			40								0.8	1.1
			50									1
			63									0.9

L.	Char.	I _{cu} [kA]	S800S									
			I _n [A]	C								125
				50								
			25	32	40	50	63	80	100	125		
S200P	C	25	0.5	T	T	T	T	T	T	T	T	
			1	3.3	T	T	T	T	T	T	T	
			1.6	0.6	1.3	T	T	T	T	T	T	
			2	0.4	0.7	1.3	T	T	T	T	T	
			3		0.4	0.6	0.7	1.1	2.6	8.8	T	
			4		0.4	0.6	0.7	1	1.7	3.1	7	
			6			0.4	0.5	0.7	1	1.5	2.6	
			8				0.4	0.6	0.7	1	1.4	
			10				0.4	0.6	0.7	1	1.4	
			13					0.5	0.7	0.9	1.3	
			16						0.7	0.9	1.3	
			20							0.9	1.3	
			25								0.9	1.3
			32								0.8	1.1
			40								0.8	1.1
			50									1
			63									0.9

L.	Char.	I _{cu} [kA]	S800S									
			I _n [A]	B								125
				50								
			25	32	40	50	63	80	100	125		
S200P	K	25	0.2	T	T	T	T	T	T	T	T	
			0.3	T	T	T	T	T	T	T	T	
			0.5	T	T	T	T	T	T	T	T	
			0.75	T	T	T	T	T	T	T	T	
			1	0.8	5	T	T	T	T	T	T	
			1.6	0.5	1	2.3	T	T	T	T	T	
			2	0.3	0.5	0.7	2.1	T	T	T	T	
			3		0.4	0.5	0.7	1.2	2.5	8.6	T	
			4		0.4	0.4	0.7	1	1.7	3	7.7	
			6				0.6	0.8	1.2	2	3.6	
			8					0.7	0.9	1.3	2	
			10						0.9	1.3	2	
			13							1	1.5	
			16								1.5	
			20									
			25									
			32									
			40									
			50									
			63									

L.	Char.	I _{cu} [kA]	S800S									
			I _n [A]	C								125
				50								
			25	32	40	50	63	80	100	125		
S200P	K	25	0.2	T	T	T	T	T	T	T	T	
			0.3	T	T	T	T	T	T	T	T	
			0.5	T	T	T	T	T	T	T	T	
			0.75	T	T	T	T	T	T	T	T	
			1	0.8	5	T	T	T	T	T	T	
			1.6	0.5	1	2.3	T	T	T	T	T	
			2	0.3	0.5	0.7	2.3	T	T	T	T	
			3		0.4	0.5	0.7	1.2	2.5	8.6	T	
			4		0.4	0.4	0.7	1	1.7	3	7.7	
			6				0.6	0.8	1.2	2	3.6	
			8					0.7	0.9	1.3	2	
			10						0.9	1.3	2	
			13							1	1.5	
			16								1.5	
			20									
			25									
			32									
			40									
			50									
			63									

E. = feed side L. = load side
T = Total selectivity up to breaking capacity of the switch on load side
Selectivity limit values indicated in kA

System pro M compact®

Technical details

Coordination tables: selectivity

L.	Char.	I _{cu} [kA]	E.		S800S						
			I _n [A]	D							
				25	32	40	50	63	80	100	125
S200P	B	25	6	0.5	1	1.2	2	2.8	9.9	21.3	T
			10	0.4	0.6	0.8	1.1	1.4	2.8	3.9	7.4
			13	0.4	0.6	0.8	1.1	1.4	2.5	3.3	5.6
			16		0.6	0.8	1.1	1.4	2.5	3.3	5.6
			20			0.8	1.1	1.3	2.3	3	4.7
			25			0.8	1.1	1.3	2.3	3	4.7
			32				0.9	1.1	1.9	2.4	3.7
	15	40					1.1	1.9	2.4	3.7	
		50						1.5	1.9	2.3	
		63							1.7	2.3	

L.	Char.	I _{cu} [kA]	E.		S800S						
			I _n [A]	D							
				25	32	40	50	63	80	100	125
S200P	C	25	0.5	T	T	T	T	T	T	T	T
			1	T	T	T	T	T	T	T	T
			1.6	T	T	T	T	T	T	T	T
			2	T	T	T	T	T	T	T	T
			3	0.7	2.2	4.4	T	T	T	T	T
			4	0.7	1.3	2.2	4.4	7.7	T	T	T
			6	0.5	1	1.2	2	2.8	9.9	22	T
			8	0.4	0.6	0.8	1.1	1.4	2.8	3.9	7.4
			10	0.4	0.6	0.8	1.1	1.4	2.8	3.9	7.4
			13	0.4	0.6	0.8	1.1	1.4	2.5	3.3	5.6
			16		0.6	0.8	1.1	1.4	2.5	3.3	5.6
			20			0.8	1.1	1.3	2.3	3	4.7
			25			0.8	1.1	1.3	2.3	3	4.7
			32				0.9	1.1	1.9	2.4	3.7
			40					1.1	1.9	2.4	3.7
			50						1.5	1.9	2.3
			63							1.7	2.3

L.	Char.	I _{cu} [kA]	E.		S800S						
			I _n [A]	D							
				25	32	40	50	63	80	100	125
S200P	K	25	0.2	T	T	T	T	T	T	T	T
			0.3	T	T	T	T	T	T	T	T
			0.5	T	T	T	T	T	T	T	T
			0.75	T	T	T	T	T	T	T	T
			1	T	T	T	T	T	T	T	T
			1.6	T	T	T	T	T	T	T	T
			2	2.3	T	T	T	T	T	T	T
			3	0.7	1.3	4.4	T	T	T	T	T
			4	0.7	1	2.2	4.4	7.7	T	T	T
			6	0.6	0.8	1.5	2.5	3.6	12	24.2	T
			8	0.5	0.7	1.1	1.5	2	4	5.5	9.9
			10	0.5	0.7	1.1	1.5	2	4	5.5	9.9
			13		0.6	0.9	1.2	1.5	2.6	3.4	5.2
			16			0.9	1.2	1.5	2.6	3.4	5.2
			20				0.9	1.1	1.8	2.2	3.2
			25						1.8	2.2	3.2
			32						1.7	2	2.9
			40							1.9	2.6
			50								2.2
			63								

E. = feed side L. = load side
 T = Total selectivity up to breaking capacity of the switch on load side
 Selectivity limit values indicated in kA

System pro M compact®

Technical details

Coordination tables: selectivity

L.	Char.	Icu [kA]	E.		S800N							
			In [A]	D								
				36								
			25	32	40	50	63	80	100	125		
S200	B	10	6	0.5	1	1.2	2	2.8	T	T	T	
			10	0.4	0.6	0.8	1.1	1.4	2.8	3.9	T	
			13	0.4	0.6	0.8	1.1	1.4	2.5	3.3	5.6	
			16		0.6	0.8	1.1	1.4	2.5	3.3	5.6	
			20			0.8	1.1	1.3	2.3	3	4.7	
			25			0.8	1.1	1.3	2.3	3	4.7	
			32				0.9	1.1	1.9	2.4	3.7	
			40					1.1	1.9	2.4	3.7	
			50						1.5	1.9	2.3	
			63							1.7	2.3	

L.	Char.	Icu [kA]	E.		S800N							
			In [A]	D								
				36								
			25	32	40	50	63	80	100	125		
S200	C	10	0.5	T	T	T	T	T	T	T	T	
			1	T	T	T	T	T	T	T	T	
			1.6	T	T	T	T	T	T	T	T	
			2	T	T	T	T	T	T	T	T	
			3	0.7	2.2	4.4	T	T	T	T	T	
			4	0.7	1.3	2.2	4.4	T	T	T	T	
			6	0.5	1	1.2	2	2.8	T	T	T	
			8	0.4	0.6	0.8	1.1	1.4	2.8	3.9	T	
			10	0.4	0.6	0.8	1.1	1.4	2.8	3.9	T	
			13	0.4	0.6	0.8	1.1	1.4	2.5	3.3	5.6	
			16		0.6	0.8	1.1	1.4	2.5	3.3	5.6	
			20			0.8	1.1	1.3	2.3	3	4.7	
			25			0.8	1.1	1.3	2.3	3	4.7	
			32				0.9	1.1	1.9	2.4	3.7	
			40					1.1	1.9	2.4	3.7	
			50						1.5	1.9	2.3	
			63							1.7	2.3	

L.	Char.	Icu [kA]	E.		S800N							
			In [A]	D								
				36								
			25	32	40	50	63	80	100	125		
S200	D	10	0.5	T	T	T	T	T	T	T	T	
			1	T	T	T	T	T	T	T	T	
			1.6	T	T	T	T	T	T	T	T	
			2	2.3	T	T	T	T	T	T	T	
			3	0.7	1.3	4.4	T	T	T	T	T	
			4	0.7	1	2.2	4.4	T	T	T	T	
			6	0.6	0.8	1.5	2.5	3.6	T	T	T	
			8	0.5	0.7	1.1	1.5	2	4	5.5	T	
			10	0.5	0.7	1.1	1.5	2	4	5.5	T	
			13		0.6	0.9	1.2	1.5	2.6	3.4	5.2	
			16			0.9	1.2	1.5	2.6	3.4	5.2	
			20				0.9	1.1	1.8	2.2	3.2	
			25					1.1	1.8	2.2	3.2	
			32						1.7	2	2.9	
			40							1.9	2.6	
			50								2.2	
			63									

L.	Char.	Icu [kA]	E.		S800N							
			In [A]	D								
				36								
			25	32	40	50	63	80	100	125		
S200	K	10	0.5	T	T	T	T	T	T	T	T	
			1	T	T	T	T	T	T	T	T	
			1.6	T	T	T	T	T	T	T	T	
			2	2.3	T	T	T	T	T	T	T	
			3	0.7	1.3	4.4	T	T	T	T	T	
			4	0.7	1	2.2	4.4	T	T	T	T	
			6	0.6	0.8	1.5	2.5	3.6	T	T	T	
			8	0.5	0.7	1.1	1.5	2	4	5.5	T	
			10	0.5	0.7	1.1	1.5	2	4	5.5	T	
			13		0.6	0.9	1.2	1.5	2.6	3.4	5.2	
			16			0.9	1.2	1.5	2.6	3.4	5.2	
			20				0.9	1.1	1.8	2.2	3.2	
			25					1.1	1.8	2.2	3.2	
			32						1.7	2	2.9	
			40							1.9	2.6	
			50								2.2	
			63									

E. = feed side L. = load side
 T = Total selectivity up to breaking capacity of the switch on load side
 Selectivity limit values indicated in kA

System pro M compact®

Technical details

Coordination tables: selectivity

MCBs

S800N - S200M @ 230/400 V

L.	Char.	Icu [kA]	S800N								
			B								
			In [A]	25	32	40	50	63	80	100	125
S200M	B	15	6			0.4	0.5	0.7	1	1.5	2.6
			10				0.4	0.6	0.7	1	1.4
			13					0.5	0.7	0.9	1.3
			16						0.7	0.9	1.3
			20							0.9	1.3
			25							0.9	1.3
			32							0.8	1.1
			40							0.8	1.1
			50								1
			63								0.9

L.	Char.	Icu [kA]	S800N								
			C								
			In [A]	25	32	40	50	63	80	100	125
S200M	B	15	6		0.4	0.5	0.7	0.9	1.4	2.4	4.8
			10		0.3	0.4	0.5	0.7	0.9	1.3	2
			13		0.3	0.4	0.5	0.7	0.9	1.3	1.9
			16		0.3	0.4	0.5	0.7	0.9	1.3	1.9
			20			0.4	0.5	0.7	0.9	1.2	1.8
			25			0.4	0.5	0.7	0.9	1.2	1.8
			32				0.5	0.6	0.8	1	1.4
			40					0.6	0.8	1	1.4
			50						0.7	0.9	1.3
			63							0.9	1.2

L.	Char.	Icu [kA]	S800N								
			B								
			In [A]	25	32	40	50	63	80	100	125
S200M	C	15	0.5	T	T	T	T	T	T	T	T
			1	3.3	T	T	T	T	T	T	T
			1.6	0.6	1.3	T	T	T	T	T	T
			2	0.4	0.7	1.3	T	T	T	T	T
			3		0.4	0.6	0.7	1.1	2.6	8.8	T
			4		0.4	0.6	0.7	1	1.7	3.1	7
			6			0.4	0.5	0.7	1	1.5	2.6
			8				0.4	0.6	0.7	1	1.4
			10				0.4	0.6	0.7	1	1.4
			13					0.5	0.7	0.9	1.3
			16						0.7	0.9	1.3
			20							0.9	1.3
			25							0.9	1.3
			32							0.8	1.1
			40							0.8	1.1
			50								1
63								0.9			

L.	Char.	Icu [kA]	S800N								
			C								
			In [A]	25	32	40	50	63	80	100	125
S200M	C	15	0.5	T	T	T	T	T	T	T	T
			1	T	T	T	T	T	T	T	T
			1.6	0.6	T	T	T	T	T	T	T
			2	0.5	1	T	T	T	T	T	T
			3	0.3	0.5	0.7	1.2	2.1	6.4	T	T
			4	0.3	0.4	0.7	1	1.5	2.6	6.1	T
			6		0.4	0.5	0.7	0.9	1.4	2.4	4.8
			8		0.3	0.4	0.5	0.7	0.9	1.3	2
			10		0.3	0.4	0.5	0.7	0.9	1.3	2
			13		0.3	0.4	0.5	0.7	0.9	1.3	1.9
			16		0.3	0.4	0.5	0.7	0.9	1.3	1.9
			20			0.4	0.5	0.7	0.9	1.2	1.8
			25			0.4	0.5	0.7	0.9	1.2	1.8
			32				0.5	0.6	0.8	1	1.4
			40					0.6	0.8	1	1.4
			50						0.7	0.9	1.3
63							0.9	1.2			

L.	Char.	Icu [kA]	S800N								
			B								
			In [A]	25	32	40	50	63	80	100	125
S200M	D	15	0.5	T	T	T	T	T	T	T	T
			1	0.8	5	T	T	T	T	T	T
			1.6	0.5	1	2.3	T	T	T	T	T
			2	0.3	0.5	0.7	2.3	T	T	T	T
			3		0.4	0.5	0.7	1.2	2.5	8.6	T
			4		0.4	0.4	0.7	1	1.7	3	7.7
			6				0.6	0.8	1.2	2	3.6
			8					0.7	0.9	1.3	2
			10						0.9	1.3	2
			13							1	1.5
			16								1.5
			20								
			25								
			32								
			40								
			50								
63											

L.	Char.	Icu [kA]	S800N								
			C								
			In [A]	25	32	40	50	63	80	100	125
S200M	D	15	0.5	T	T	T	T	T	T	T	T
			1	2.1	T	T	T	T	T	T	T
			1.6	0.8	2.3	T	T	T	T	T	T
			2	0.4	0.7	2.3	T	T	T	T	T
			3	0.3	0.5	0.7	1.2	2.2	6.4	T	T
			4	0.3	0.4	0.7	1	1.4	2.6	6.2	T
			6		0.4	0.6	0.8	1.1	1.8	3.2	6.4
			8			0.5	0.7	0.9	1.2	1.8	2.8
			10				0.7	0.9	1.2	1.8	2.8
			13					0.7	1	1.4	2
			16						1	1.4	2
			20							1	1.4
			25								1.4
			32								
			40								
			50								
63											

L.	Char.	Icu [kA]	S800N								
			B								
			In [A]	25	32	40	50	63	80	100	125
S200M	K	15	0.5	T	T	T	T	T	T	T	T
			1	0.8	5	T	T	T	T	T	T
			1.6	0.5	1	2.3	T	T	T	T	T
			2	0.3	0.5	0.7	2.3	T	T	T	T
			3		0.4	0.5	0.7	1.2	2.5	8.6	T
			4		0.4	0.4	0.7	1	1.7	3	7.7
			6				0.6	0.8	1.2	2	3.6
			8					0.7	0.9	1.3	2
			10						0.9	1.3	2
			13							1	1.5
			16								1.5
			20								
			25								
			32								
			40								
			50								
63											

L.	Char.	Icu [kA]	S800N								
			C								
			In [A]	25	32	40	50	63	80	100	125
S200M	K	15	0.5	T	T	T	T	T	T	T	T
			1	2.1	T	T	T	T	T	T	T
			1.6	0.8	2.3	T	T	T	T	T	T
			2	0.4	0.7	2.3	T	T	T	T	T
			3	0.3	0.5	0.7	1.2	2.2	6.4	T	T
			4	0.3	0.4	0.7	1	1.4	2.6	6.2	T
			6		0.4	0.6	0.8	1.1	1.8	3.2	6.4
			8			0.5	0.7	0.9	1.2	1.8	2.8
			10				0.7	0.9	1.2	1.8	2.8
			13					0.7	1	1.4	2
			16						1	1.4	2
			20							1	1.4
			25								1.4
			32								
			40								
			50								
63											

E. = feed side L. = load side
 T = Total selectivity up to breaking capacity of the switch on load side
 Selectivity limit values indicated in kA

System pro M compact®

Technical details

Coordination tables: selectivity

L.	Char.	Icu [kA]	E.		S800N							
			In [A]	D								
				36								
			25	32	40	50	63	80	100	125		
S200M	B	15	6	0.5	1	1.2	2	2.8	T	T	T	
			10	0.4	0.6	0.8	1.1	1.4	2.8	3.9	7.4	
			13	0.4	0.6	0.8	1.1	1.4	2.5	3.3	5.6	
			16		0.6	0.8	1.1	1.4	2.5	3.3	5.6	
			20			0.8	1.1	1.3	2.3	3	4.7	
			25			0.8	1.1	1.3	2.3	3	4.7	
			32				0.9	1.1	1.9	2.4	3.7	
			40					1.1	1.9	2.4	3.7	
			50						1.5	1.9	2.3	
			63							1.7	2.3	

L.	Char.	Icu [kA]	E.		S800N							
			In [A]	D								
				36								
			25	32	40	50	63	80	100	125		
S200M	C	15	0.5	T	T	T	T	T	T	T	T	
			1	T	T	T	T	T	T	T	T	
			1.6	T	T	T	T	T	T	T	T	
			2	T	T	T	T	T	T	T	T	
			3	0.7	2.2	4.4	T	T	T	T	T	
			4	0.7	1.3	2.2	4.4	7.7	T	T	T	
			6	0.5	1	1.2	2	2.8	T	T	T	
			8	0.4	0.6	0.8	1.1	1.4	2.8	3.9	7.4	
			10	0.4	0.6	0.8	1.1	1.4	2.8	3.9	7.4	
			13	0.4	0.6	0.8	1.1	1.4	2.5	3.3	5.6	
			16		0.6	0.8	1.1	1.4	2.5	3.3	5.6	
			20			0.8	1.1	1.3	2.3	3	4.7	
			25			0.8	1.1	1.3	2.3	3	4.7	
			32				0.9	1.1	1.9	2.4	3.7	
			40					1.1	1.9	2.4	3.7	
			50						1.5	1.9	2.3	
			63							1.7	2.3	

L.	Char.	Icu [kA]	E.		S800N							
			In [A]	D								
				36								
			25	32	40	50	63	80	100	125		
S200M	D	15	0.5	T	T	T	T	T	T	T	T	
			1	T	T	T	T	T	T	T	T	
			1.6	T	T	T	T	T	T	T	T	
			2	2.3	T	T	T	T	T	T	T	
			3	0.7	1.3	4.4	T	T	T	T	T	
			4	0.7	1	2.2	4.4	7.7	T	T	T	
			6	0.6	0.8	1.5	2.5	3.6	T	T	T	
			8	0.5	0.7	1.1	1.5	2	4	5.5	T	
			10	0.5	0.7	1.1	1.5	2	4	5.5	T	
			13		0.6	0.9	1.2	1.5	2.6	3.4	5.2	
			16			0.9	1.2	1.5	2.6	3.4	5.2	
			20				0.9	1.1	1.8	2.2	3.2	
			25					1.1	1.8	2.2	3.2	
			32						1.7	2	2.9	
			40							1.9	2.6	
			50								2.2	
			63									

L.	Char.	Icu [kA]	E.		S800N							
			In [A]	D								
				36								
			25	32	40	50	63	80	100	125		
S200M	K	15	0.5	T	T	T	T	T	T	T	T	
			1	T	T	T	T	T	T	T	T	
			1.6	T	T	T	T	T	T	T	T	
			2	2.3	T	T	T	T	T	T	T	
			3	0.7	1.3	4.4	T	T	T	T	T	
			4	0.7	1	2.2	4.4	7.7	T	T	T	
			6	0.6	0.8	1.5	2.5	3.6	T	T	T	
			8	0.5	0.7	1.1	1.5	2	4	5.5	T	
			10	0.5	0.7	1.1	1.5	2	4	5.5	T	
			13		0.6	0.9	1.2	1.5	2.6	3.4	5.2	
			16			0.9	1.2	1.5	2.6	3.4	5.2	
			20				0.9	1.1	1.8	2.2	3.2	
			25					1.1	1.8	2.2	3.2	
			32						1.7	2	2.9	
			40							1.9	2.6	
			50								2.2	
			63									

E. = feed side L. = load side
 T = Total selectivity up to breaking capacity of the switch on load side
 Selectivity limit values indicated in kA

S800N - S200P @ 230/400 V

L.	Char.	Icu [kA]	E.	S800N												
			In [A]	B												
				36												
S200P	B	25	6			0.4	0.5	0.7	1	1.5	2.6					
			10				0.4	0.6	0.7	1	1.4					
			13					0.5	0.7	0.9	1.3					
			16						0.7	0.9	1.3					
			20							0.9	1.3					
			25							0.9	1.3					
	15	32							0.8	1.1						
		40							0.8	1.1						
		50								1						
		63								0.9						

L.	Char.	Icu [kA]	E.	S800N												
			In [A]	C												
				36												
S200P	B	25	6			0.4	0.5	0.7	1	1.5	2.6					
			10				0.4	0.6	0.7	1	1.4					
			13					0.5	0.7	0.9	1.3					
			16						0.7	0.9	1.3					
			20							0.9	1.3					
			25							0.9	1.3					
	15	32							0.8	1.1						
		40							0.8	1.1						
		50								1						
		63								0.9						

L.	Char.	Icu [kA]	E.	S800N													
			In [A]	B													
				36													
S200P	C	25	0.5	T	T	T	T	T	T	T	T						
			1	3.3	T	T	T	T	T	T	T	T					
			1.6	0.6	1.3	T	T	T	T	T	T	T					
			2	0.4	0.7	1.3	T	T	T	T	T	T					
			3		0.4	0.6	0.7	1.1	2.6	8.8	T	T					
			4		0.4	0.6	0.7	1	1.7	3.1	7						
			6			0.4	0.5	0.7	1	1.5	2.6						
			8				0.4	0.6	0.7	1	1.4						
			10				0.4	0.6	0.7	1	1.4						
			13					0.5	0.7	0.9	1.3						
			16						0.7	0.9	1.3						
			20							0.9	1.3						
			25							0.9	1.3						
			32							0.8	1.1						
			40							0.8	1.1						
			50								1						
			63								0.9						

L.	Char.	Icu [kA]	E.	S800N													
			In [A]	C													
				36													
S200P	C	25	0.5	T	T	T	T	T	T	T	T						
			1	3.3	T	T	T	T	T	T	T	T					
			1.6	0.6	1.3	T	T	T	T	T	T	T					
			2	0.4	0.7	1.3	T	T	T	T	T	T					
			3		0.4	0.6	0.7	1.1	2.6	8.8	T	T					
			4		0.4	0.6	0.7	1	1.7	3.1	7						
			6			0.4	0.5	0.7	1	1.5	2.6						
			8				0.4	0.6	0.7	1	1.4						
			10				0.4	0.6	0.7	1	1.4						
			13					0.5	0.7	0.9	1.3						
			16						0.7	0.9	1.3						
			20							0.9	1.3						
			25							0.9	1.3						
			32							0.8	1.1						
			40							0.8	1.1						
			50								1						
			63								0.9						

L.	Char.	Icu [kA]	E.	S800N													
			In [A]	B													
				36													
S200P	K	25	0.2	T	T	T	T	T	T	T	T						
			0.3	T	T	T	T	T	T	T	T	T					
			0.5	T	T	T	T	T	T	T	T	T					
			0.75	T	T	T	T	T	T	T	T	T					
			1	0.8	5	T	T	T	T	T	T	T					
			1.6	0.5	1	2.3	T	T	T	T	T	T					
			2	0.3	0.5	0.7	2.1	T	T	T	T	T					
			3		0.4	0.5	0.7	1.2	2.5	8.6	T	T					
			4		0.4	0.4	0.7	1	1.7	3	7.7						
			6				0.6	0.8	1.2	2	3.6						
			8					0.7	0.9	1.3	2						
			10						0.9	1.3	2						
			13							1	1.5						
			16								1.5						
			20														
			25														
			32														
			40														
			50														
			63														

L.	Char.	Icu [kA]	E.	S800N													
			In [A]	C													
				36													
S200P	K	25	0.2	T	T	T	T	T	T	T	T						
			0.3	T	T	T	T	T	T	T	T	T					
			0.5	T	T	T	T	T	T	T	T	T					
			0.75	T	T	T	T	T	T	T	T	T					
			1	0.8	5	T	T	T	T	T	T	T					
			1.6	0.5	1	2.3	T	T	T	T	T	T					
			2	0.3	0.5	0.7	2.3	T	T	T	T	T					
			3		0.4	0.5	0.7	1.2	2.5	8.6	T	T					
			4		0.4	0.4	0.7	1	1.7	3	7.7						
			6				0.6	0.8	1.2	2	3.6						
			8					0.7	0.9	1.3	2						
			10						0.9	1.3	2						
			13							1	1.5						
			16								1.5						
			20														
			25														
			32														
			40														
			50														
			63														

E. = feed side L. = load side
 T = Total selectivity up to breaking capacity of the switch on load side
 Selectivity limit values indicated in kA

System pro M compact®

Technical details

Coordination tables: selectivity

L.	Char.	Icu [kA]	E.		S800N							
			In [A]	D								
				36								
			25	32	40	50	63	80	100	125		
S200P	B	25	6	0.5	1	1.2	2	2.8	9.9	21.3	T	
			10	0.4	0.6	0.8	1.1	1.4	2.8	3.9	7.4	
			13	0.4	0.6	0.8	1.1	1.4	2.5	3.3	5.6	
			16		0.6	0.8	1.1	1.4	2.5	3.3	5.6	
			20			0.8	1.1	1.3	2.3	3	4.7	
			25			0.8	1.1	1.3	2.3	3	4.7	
	15	32				0.9	1.1	1.9	2.4	3.7		
		40					1.1	1.9	2.4	3.7		
		50						1.5	1.9	2.3		
		63							1.7	2.3		

L.	Char.	Icu [kA]	E.		S800N							
			In [A]	D								
				36								
			25	32	40	50	63	80	100	125		
S200P	C	25	0.5	T	T	T	T	T	T	T	T	
			1	T	T	T	T	T	T	T	T	
			1.6	T	T	T	T	T	T	T	T	
			2	T	T	T	T	T	T	T	T	
			3	0.7	2.2	4.4	T	T	T	T	T	
			4	0.7	1.3	2.2	4.4	7.7	T	T	T	
			6	0.5	1	1.2	2	2.8	9.9	22	T	
			8	0.4	0.6	0.8	1.1	1.4	2.8	3.9	7.4	
			10	0.4	0.6	0.8	1.1	1.4	2.8	3.9	7.4	
			13	0.4	0.6	0.8	1.1	1.4	2.5	3.3	5.6	
			16		0.6	0.8	1.1	1.4	2.5	3.3	5.6	
			20			0.8	1.1	1.3	2.3	3	4.7	
			25			0.8	1.1	1.3	2.3	3	4.7	
			15	32				0.9	1.1	1.9	2.4	3.7
				40					1.1	1.9	2.4	3.7
	50							1.5	1.9	2.3		
	63								1.7	2.3		

L.	Char.	Icu [kA]	E.		S800N							
			In [A]	D								
				36								
			25	32	40	50	63	80	100	125		
S200P	K	25	0.2	T	T	T	T	T	T	T	T	
			0.3	T	T	T	T	T	T	T	T	
			0.5	T	T	T	T	T	T	T	T	
			0.75	T	T	T	T	T	T	T	T	
			1	T	T	T	T	T	T	T	T	
			1.6	T	T	T	T	T	T	T	T	
			2	2.3	T	T	T	T	T	T	T	
			3	0.7	1.3	4.4	T	T	T	T	T	
			4	0.7	1	2.2	4.4	7.7	T	T	T	
			6	0.6	0.8	1.5	2.5	3.6	12	24.2	T	
			8	0.5	0.7	1.1	1.5	2	4	5.5	9.9	
			10	0.5	0.7	1.1	1.5	2	4	5.5	9.9	
			13		0.6	0.9	1.2	1.5	2.6	3.4	5.2	
			16			0.9	1.2	1.5	2.6	3.4	5.2	
			20				0.9	1.1	1.8	2.2	3.2	
	25					1.1	1.8	2.2	3.2			
	15	32						1.7	2	2.9		
		40							1.9	2.6		
		50								2.2		
		63										

E. = feed side L. = load side
T = Total selectivity up to breaking capacity of the switch on load side
Selectivity limit values indicated in kA

Functional diagram of selective main circuit breakers S 700

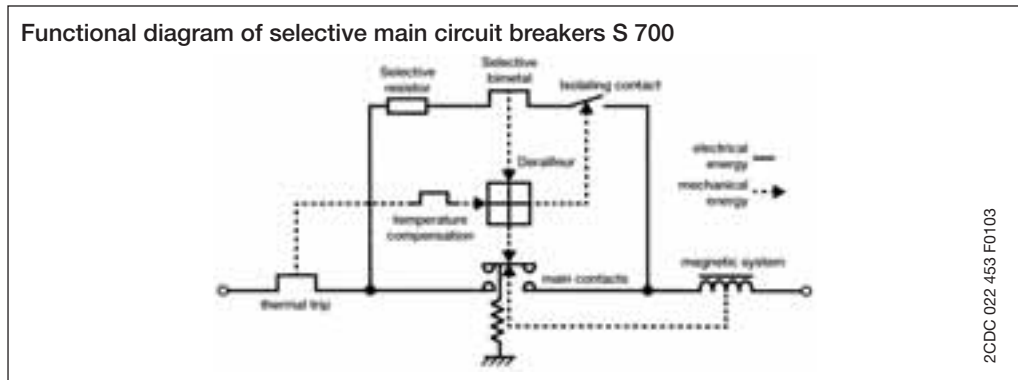

2CDC 022 453 F0103

Back-up protection

Selective main circuit breakers of the S 700 series are capable of switching off short-circuit currents of up to 25 kA automatically in networks with a rated voltage of 230/400 V. Back-up protection is necessary only when the prospective short-circuit current may exceed 25 kA prosp. at the installation point. Further information on back-up protection on request.

Short circuit discrimination

When ABB miniature circuit-breaker are used in combination with the S 700, higher short-circuit currents can be disconnected than are indicated as permissible rated switching capacity of device. Considering the values given in the table, the S 700 operates selectively with respect to the combination with the final device. If other mcbs are used selectivity for 6 kA and 10 kA devices is available up to the rated switching capacity of the final device.

MCB



Supply side		S 700										fuse									
Load side	Char.	Icu [kA]	E/K										gG								
			25										16	20	25	35	50	63	80	100	
		In [A]	16	20	25	35	40	50	63	80	100	16	20	25	35	50	63	80	100		
S 200	C	m 2	>15	>15	>15	>15	>15	>15	>15	>15	>15	1	1.2	4	>15	>15	>15	>15	>15		
		3	10	10	10	10	10	10	10	8	8	0.3	0.7	1.2	4.6	6	6	6	6		
	B, C	4	10	10	10	10	10	10	10	8	8	0.3	0.6	0.9	2.8	6	6	6	6		
		6	10	10	10	10	10	10	10	8	8	0.2	0.5	0.8	2	3.3	5.5	6	6		
	B, C	6	8	10	10	10	10	10	10	10	8	8	0.2	0.4	0.7	1.7	2.8	4.5	6	6	
			10	10	10	10	10	10	10	10	8	8	0.2	0.4	0.7	1.5	2.5	3.5	5	6	
		13	10	10	10	10	10	10	10	8	8			0.7	1.5	2.5	3.5	5	6		
		16		10	10	10	10	10	10	8	8			1.3	2	2.9	4.1	6			
		20			10	10	10	10	10	8	8				1.8	2.6	3.5	5			
		25				10	10	10	10	8	8				1.8	2.6	3.5	5			
		32					10	10	10	8	8					2.2	3	4			
		40						10	10	8	8						2.5	4			
		50/63								8	8								3.5		
		S 200 M	C	m 2	>15	>15	>15	>15	>15	>15	>15	>15	>15	1	1.2	4	>15	>15	>15	>15	>15
3	15			15	15	15	15	15	15	15	10	10	0.3	0.7	1.2	4.6	10	10	10	10	
B, C	4		15	15	15	15	15	15	15	15	10	10	0.3	0.6	0.9	2.8	10	10	10	10	
	6		15	15	15	15	15	15	15	15	10	10	0.2	0.5	0.8	1.7	3.1	7	10	10	
B, C	6		8	15	15	15	15	15	15	15	15	10	10	0.2	0.4	0.7	1.4	2.3	3.4	4.8	7.5
			10	15	15	15	15	15	15	15	15	10	10	0.2	0.4	0.7	1.4	2.3	3.4	4.8	7.5
	13		15	15	15	15	15	15	15	15	10	10			0.7	1.4	2.3	3.4	4.8	7.5	
	16			15	15	15	15	15	15	15	10	10			1.3	2	2.9	4.2	6		
	20				15	15	15	15	15	15	10	10				1.9	2.7	3.8	5.6		
	25					15	15	15	15	15	10	10				1.9	2.6	3.6	5.4		
	32						15	15	15	15	10	10					2.4	3.2	4.2		
	40							15	15	10	10						3.2	4.2			
	50/63									10	10								3.8		

Limited overload selectivity

MCB

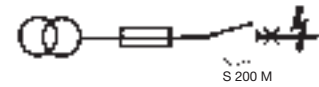
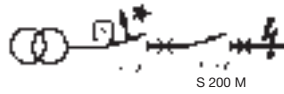

Load side	Supply side		S 700										fuse												
	Char.	Icu [kA]	E/K										gG												
			25																						
			In [A]	16	20	25	35	40	50	63	80	100	16	20	25	35	50	63	80	100					
S 200 S 200 M	K	6	≤ 2	>15	>15	>15	>15	>15	>15	>15	>15	>15	>15	0.3	1.2	4	>15	>15	>15	>15	>15				
			3	10	10	10	10	10	10	10	10	10	10	10	0.3	0.7	1.2	4.6	6	6	6	6			
			4	10	10	10	10	10	10	10	10	10	10	10	0.3	0.6	0.9	2.8	6	6	6	6			
			6	10	10	10	10	10	10	10	10	10	10	10			0.7	1.7	3	5.9	6	6			
			8	10	10	10	10	10	10	10	10	10	10	10				1.3	2.2	3.6	6	6			
			10	10	10	10	10	10	10	10	10	10	10	10					1.7	2.5	4	6			
			16		10	10	10	10	10	10	10	10	10	10						2.2	3.1	4.6			
			20			10	10	10	10	10	10	10	10	10								3.1	4.6		
			25				10	10	10	10	10	10	10	10									2.6	3.5	
			32					10	10	10	10	10	10	10											3.5
			40						10	10	10	10	10	10											
			50/63										10	10											
S 200 S 200 M	Z	6	≤ 2	>15	>15	>15	>15	>15	>15	>15	>15	>15	0.5	2	>15	>15	>15	>15	>15	>15					
			3	10	10	10	10	10	10	10	10	10	10	0.3	0.7	1.8	6	6	6	6	6				
			4	10	10	10	10	10	10	10	10	10	10	0.3	0.6	1.3	7	6	6	6	6				
			6	10	10	10	10	10	10	10	10	10	10	0.2	0.5	0.9	2.7	6	6	6	6				
			8	10	10	10	10	10	10	10	10	10	10	0.2	0.5	0.6	1.7	3.8	6	6	6				
			10	10	10	10	10	10	10	10	10	10	10		0.4	0.6	1.3	2.4	4	6	6				
			16		10	10	10	10	10	10	10	10	10			0.5	1.1	1.7	3	4.5	6				
			20			10	10	10	10	10	10	10	10				0.9	1.5	2.3	3.5	5.2				
			25				10	10	10	10	10	10	10					1.4	2	3	4				
			32					10	10	10	10	10	10						1.4	2	3	4			
			40						10	10	10	10	10							2	3	4			
			50/63										10	10								2.2	3.5		

■ Limited overload selectivity

MCB



		S 700										fuse									
		E/K										gG									
Supply side	Char.	25																			
Load side		Icu [kA]	In [A]																		
			16	20	25	35	40	50	63	80	100	16	20	25	35	50	63	80	100		
S 200 P	B	6	6	25	25	25	25	25	25	25	25	25	0.2	0.4	0.6	1.2	2.2	3.7	6	10	
			10	25	25	25	25	25	25	25	25	25	25	0.2	0.4	0.6	1.1	1.8	2.7	4	6
			13	25	25	25	25	25	25	25	25	25	25			0.6	1	1.7	2.5	3.7	5.5
			16		25	25	25	25	25	25	25	25	25				1	1.6	2.4	3.5	5.3
			20			25	25	25	25	25	25	25	25				1	1.6	2.2	3.3	4.7
			25				25	25	25	25	25	25	25					1.5	2	3	4
			32					25	25	25	25	25	25					1.3	2	2.8	3.6
			40						25	25	25	25	25						1.9	2.7	3.4
			50/63									10	10							2.7	3.4
			S 200 P	C	6	≤ 2	>25	>25	>25	>25	>25	>25	>25	>25	1	2	>25	>25	>25	>25	>25
3	25	25				25	25	25	25	25	25	25	0.3	0.8	1.5	6	10	10	10		
4	25	25				25	25	25	25	25	25	25	25	0.3	0.6	1	3.3	6	10	10	
6	25	25				25	25	25	25	25	25	25	25			0.6	1.3	3	5.5	10	
8	25	25				25	25	25	25	25	25	25	25				1.1	2.9	3.5	6	
10	25	25				25	25	25	25	25	25	25	25				1	1.7	2.5	4	
13	25	25				25	25	25	25	25	25	25	25					1.8	2.2	3	
16		25				25	25	25	25	25	25	25	25					1.6	2	3	
20						25	25	25	25	25	25	25	25						1.6	2.8	
25							25	25	25	25	25	25	25							2.4	
S 200 P	K	6	≤ 2	>15	>15	>15	>15	>15	>15	>15	>15	0.3	1	>15	>15	>15	>15	>15			
			3	15	15	15	15	15	15	15	15	15	0.3	0.8	1.5	6	6	6	10		
			4	15	15	15	15	15	15	15	15	15	15	0.3	0.6	1	3.3	6	6	10	
			6	15	15	15	15	15	15	15	15	15	15			0.6	1.3	3	5.5		
			8	15	15	15	15	15	15	15	15	15	15				1.1	2.5	3.5	6	
			10	25	25	25	25	25	25	25	25	25	25				1	1.7	2.5	4	
			13	25	25	25	25	25	25	25	25	25	25					1.6	2.2	3	
			16		25	25	25	25	25	25	25	25	25					1.5	2	3	
			20			25	25	25	25	25	25	25	25						1.6	2.6	
			25				15	15	15	15	15	15	15							2.4	
S 200 P	Z	6	≤ 2	>15	>15	>15	>15	>15	>15	>15	>15	0.3	1	>15	>15	>15	>15	>15			
			3	15	15	15	15	15	15	15	15	15	0.3	0.6	1.8	10	10	10	10		
			4	15	15	15	15	15	15	15	15	15	15	0.3	0.6	0.6	1.3	6	10	10	
			6	15	15	15	15	15	15	15	15	15	15			0.8	2.6	6	10		
			8	15	15	15	15	15	15	15	15	15	15				1.7	3.4	7		
			10	25	25	25	25	25	25	25	25	25	25				1.3	2.2	3.7		
			16		25	25	25	25	25	25	25	25	25					1.7	2.8		
			20			25	25	25	25	25	25	25	25						2.1		
			25				15	15	15	15	15	15	15							2.6	
			32					15	15	15	15	15	15								

Limited overload selectivity

Limit of selectivity

For the coordination of MCB, S 700 and upstream fuses the following selectivity limits can be assumed:



		Upstream fuse 63 A gG							fuse 80 A gG							
		S 700							S 700							
		E/K							E/K							
		25							25							
Load side	Char.	Icu [kA]	In [A]	35	40	50	63	80	100	35	40	50	63	80	100	
			S 200	C	6	≤ 2	>15	>15	>15	>15	>15	>15	>15	>15	>15	>15
		3	10	10		10	10	10	10	10	10	10	10	10	8	8
		4	10	10		10	10	10	10	10	10	10	10	10	8	8
	B, C	6	10	10		10	10	10	10	10	10	10	10	10	8	8
	C	8	7.5	7		7	6	6	6	6	10	10	10	8	8	8
		10	7.5	7		7	6	6	6	6	10	10	10	8	8	8
		13	6	6		6	6	6	6	6	10	10	9	7.5	6	6
		16	6	6		6	6	6	6	6	10	10	9	7.5	6	6
		20	6	6		5	5	5	5	5	9	8	8	6	6	6
		25		4.5		4.5	4.5	4.5	4.5	4.5		7.5	7.5	6	6	6
		32				4.5	4.5	4.5	4.5	4.5			6	6	6	6
		40					4	4	4	4				6	6	6
		50													4.5	4.5
		50/63														

		Upstream fuse 100 A gG							fuse ≥ 125 A gG							
		S 700							S 700							
		E/K							E/K							
		25							25							
Load side	Char.	Icu [kA]	In [A]	35	40	50	63	80	100	35	40	50	63	80	100	
			S 200	C	6	≤ 2	>15	>15	>15	>15	>15	>15	>15	>15	>15	>15
		3	10	10		10	10	10	8	8	10	10	10	10	8	8
		4	10	10		10	10	10	8	8	10	10	10	10	8	8
	B, C	6	10	10		10	10	10	8	8	10	10	10	10	8	8
	C	8	10	10		10	10	10	8	8	10	10	10	10	8	8
		10	10	10		10	10	10	8	8	10	10	10	10	8	8
		13	10	10		10	10	10	8	8	10	10	10	10	8	8
		16	10	10		10	10	10	8	8	10	10	10	10	8	8
		20	10	10		10	10	10	8	8	10	10	10	10	8	8
		25		10		10	10	10	8	8		10	10	10	8	8
		32				10	10	10	8	7.5			10	10	8	8
		40					10	10	8	7				10	8	8
		50						10	8	7					8	8
		63							7	6						8

Values for < 6 A and 8 A are only valid for C characteristic.

		Upstream fuse 63 A gG							fuse 80 A gG							
		Supply side S 700							S 700							
		Char. E/K							E/K							
		Icu [kA] 25							25							
Load side		In [A]	35	40	50	63	80	100	35	40	50	63	80	100		
S 200 M	C	≤ 2	>15	>15	>15	>15	>15	>15	>15	>15	>15	>15	>15	>15		
		3	15	15	15	15			15	15	15	15	10			
		4	15	15	15	15			15	15	15	15	10			
		6	15	15	15	15			15	15	15	15	10			
	B, C	C	8	7.5	7	7	6			12.5	10	10	10	6		
			10	7.5	7	7	6			12.5	10	10	10	6		
		10	B, C	13	6	6	6	5			10	10	9	7.5	6	
				16	6	6	6	5			10	10	9	7.5	6	
			20	6	6	5	5			9	8	8	6	6		
			25		4.5	4.5	4.5				7.5	7.5	6	6		
			32			4.5	4.5					6	6	6		
			40				4						6	6		
			50											4.5		
			63												4.5	

		Upstream fuse 100 A gG							fuse ≥ 125 A gG							
		Supply side S 700							S 700							
		Char. E/K							E/K							
		Icu [kA] 25							25							
Load side		In [A]	35	40	50	63	80	100	35	40	50	63	80	100		
S 200 M	C	≤ 2	>15	>15	>15	>15	>15	>15	>15	>15	>15	>15	>15	>15		
		3	15	15	15	15	10	10	15	15	15	15	10	10		
		4	15	15	15	15	10	10	15	15	15	15	10	10		
		6	15	15	15	15	10	10	15	15	15	15	10	10		
	B, C	C	8	15	15	15	15	10	10	15	15	15	15	10	10	
			10	15	15	15	15	10	10	15	15	15	15	10	10	
		10	B, C	13	15	12.5	12.5	12.5	10	10	15	15	15	15	10	10
				16	15	12.5	12.5	12.5	10	10	15	15	15	15	10	10
			20	12.5	10	12.5	10	10	10	15	15	15	15	10	10	
			25		10	10	10	10	9		15	15	15	10	10	
			32			10	10	10	7.5			15	15	10	10	
			40				10	9	7				15	10	10	
			50					7	6					10	10	
			63						5						10	

Values for < 6 A and 8 A are only valid for C characteristic.

Upstream		fuse 63 A gG							fuse 80 A gG								
Supply side		S 700							S 700								
Load side	Char.	Icu [kA]	E/K							E/K							
			25							25							
			In [A]	35	40	50	63	80	100	35	40	50	63	80	100		
S 200 P	C	25	≤ 2	>25	>25	>15	>15			>25	>25	>25	>25	>25			
			3	15	15	15	15			25	25	15	15	15			
			4	15	15	15	15			25	25	15	15	15			
	B, C		6	15	15	15	15			25	25	15	15	15			
			C	8	7.5	7	7	6			12.5	10	12.5	10	10		
	B, C		15	10	7.5	7	7	6			12.5	10	12.5	10	6		
				13	6	6	6	5			10	10	10	8	6		
				16	6	6	6	5			10	10	10	8	6		
				20	6	6	5	5			9	8	8	7	6		
		25			4.5	4.5	4.5				7.5	7.5	6	6			
		32				4.5	4.5					6	6	6			
				40			4						6	6			
				50											4.5		
				63													

Upstream		fuse 100 A gG							fuse 125 A gG							
Supply side		S 700							S 700							
Load side	Char.	Icu [kA]	E/K							E/K						
			25							25						
			In [A]	35	40	50	63	80	100	35	40	50	63	80	100	
S 200 P	C	25	≤ 2	>25	>25	>25	>25	>25	>25	>25	>25	>25	>25	>25	>25	>25
			3	25	25	25	25	25	25	25	25	25	25	25	25	25
			4	25	25	25	25	25	25	25	25	25	25	25	25	25
	B, C		6	25	25	25	25	25	25	25	25	25	25	25	25	25
			C	8	20	17	15	15	13	10	25	25	25	25	15	15
	B, C		15	10	20	17	15	15	13	10	25	25	25	25	25	25
				13	19	17	15	12.5	10	10	25	25	25	25	25	25
				16	19	17	15	12.5	10	10	25	25	25	25	25	25
				20	17	17	15	10	10	10	25	25	25	25	25	25
		25			15	15	10	10	9		25	22	20	20	20	
		32				15	10	10	9			20	20	15	20	
				40			10	9	9				15	15	15	
				50				7	7					10	10	
				63					6						10	

Upstream		fuse 160 A gG							fuse ≥ 200 A gG							
Supply side		S 700							S 700							
Load side	Char.	Icu [kA]	E/K							E/K						
			25							25						
			In [A]	35	40	50	63	80	100	35	40	50	63	80	100	
S 200 P	C	25	≤ 2	>25	>25	>25	>25	>25	>25	>25	>25	>25	>25	>25	>25	>25
			3	25	25	25	25	25	25	25	25	25	25	25	25	25
			4	25	25	25	25	25	25	25	25	25	25	25	25	25
	B, C		6	25	25	25	25	25	25	25	25	25	25	25	25	25
			C	8	25	25	25	25	15	15	25	25	25	25	15	15
	B, C		15	10	25	25	25	25	25	25	25	25	25	25	25	25
				13	25	25	25	25	25	25	25	25	25	25	25	25
				16	25	25	25	25	25	25	25	25	25	25	25	25
				20	25	25	25	25	25	25	25	25	25	25	25	25
		25			25	25	25	25	25		25	25	25	25	25	
		32				25	25	25	25			25	25	25	25	
				40			25	25	25				25	25	25	
				50				25	25					25	25	
				63					15	10				25	10	
										10					10	

Values for < 6 A and 8 A are only valid for C characteristic.

System pro M compact®

Technical details

Coordination tables: selectivity

MCBs

MCCB - S2.. B @ 415 V

Char.	I _{cu} [kA]	Supply S.			Release	T2	T1 - T2							T1 - T2 - T3								
		10	15	25			B, C, N, S, H, L															
							TM															
							I _n [A]	12.5	16	20	25	32	40	50	63	80	100	125	160			
Load S.	B	-	-	-	≤2																	
		-	-	-	3																	
		-	-	-	4																	
		S200	S200M	S200P	6	5.5 ¹	5.5	5.5	5.5	5.5	5.5	5.5	5.5	10.5	T	T	T	T				
		S200	S200M	S200P	8			5.5	5.5	5.5	5.5	5.5	5.5	10.5	T	T	T	T				
		S200	S200M	S200P	10			3 ¹	3	3	3	3	4.5	7.5	8.5	17	T	T				
		S200	S200M	S200P	13			3 ¹		3	3	4.5	7.5	7.5	12	20	T					
		S200	S200M	S200P	16					3 ¹	3	4.5	5	7.5	12	20	T					
		S200	S200M	S200P	20					3 ¹		3	5	6	10	15	T					
		S200	S200M	S200P	25							3 ¹	5	6	10	15	T					
		S200	S200M-S200P	-	32							3 ¹		6	7.5	12	T					
		S200	S200M-S200P	-	40									5.5 ¹	7.5	12	T					
		S200	S200M-S200P	-	50									3 ¹	5 ²	7.5	10.5					
		S200	S200M-S200P	-	63										5 ²	6 ³	10.5					
		-	-	-	80																	
-	-	-	100																			
-	-	-	125																			

¹ Value valid only for T2 magnetic only supply side circuit-breaker
² Value valid only for T2-T3 magnetic only supply side circuit-breaker
³ Value valid only for T3 magnetic only supply side circuit-breaker
⁴ Value valid only for T4 magnetic only supply side circuit-breaker

MCCB - S2.. C @ 415 V

Char.	I _{cu} [kA]	Supply S.			Release	T2	T1 - T2							T1 - T2 - T3									
		10	15	25			B, C, N, S, H, L																
							TM																
							I _n [A]	12.5	16	20	25	32	40	50	63	80	100	125	160				
Load S.	C	S200	S200M	S200P	≤2	T	T	T	T	T	T	T	T	T	T	T	T	T	T	T	T		
		S200	S200M	S200P	3	T	T	T	T	T	T	T	T	T	T	T	T	T	T	T	T	T	
		S200	S200M	S200P	4	T	T	T	T	T	T	T	T	T	T	T	T	T	T	T	T	T	
		S200	S200M	S200P	6	5.5 ¹	5.5	5.5	5.5	5.5	5.5	5.5	5.5	10.5	T	T	T	T	T				
		S200	S200M	S200P	8			5.5	5.5	5.5	5.5	5.5	5.5	10.5	T	T	T	T					
		S200	S200M	S200P	10			3 ¹	3	3	3	3	4.5	7.5	8.5	17	T	T					
		S200	S200M	S200P	13			3 ¹		3	3	4.5	7.5	7.5	12	20	T						
		S200	S200M	S200P	16					3 ¹	3	4.5	5	7.5	12	20	T						
		S200	S200M	S200P	20					3 ¹		3	5	6	10	15	T						
		S200	S200M	S200P	25							3 ¹	5	6	10	15	T						
		S200	S200M-S200P	-	32							3 ¹		6	7.5	12	T						
		S200	S200M-S200P	-	40									5.5 ¹	7.5	12	T						
		S200	S200M-S200P	-	50									3 ¹	5 ²	7.5	10.5						
		S200	S200M-S200P	-	63										5 ²	6 ³	10.5						
		-	S290	-	80																		4 ³
-	S290	-	100																		4 ³		
-	S290	-	125																				

¹ Value valid only for T2 magnetic only supply side circuit-breaker
² Value valid only for T2-T3 magnetic only supply side circuit-breaker
³ Value valid only for T3 magnetic only supply side circuit-breaker
⁴ Value valid only for T4 magnetic only supply side circuit-breaker
⁵ Value valid only for T4 In 160 magnetic only supply side circuit-breaker

System
pro M compact® Technical details
Coordination tables:
selectivity

MCBs

T3	T4												T5	T2				T4		T5	
B, C, N, S, H, L, V																					
TM													EL								
200	250	20	25	32	50	80	100	125	160	200	250	320÷500	10	25	63	100	160	100, 160	250, 320	320÷630	
T	T	7.5	7.5 ⁴	7.5	7.5	T	T	T	T	T	T	T	T	T	T	T	T	T	T	T	
T	T	7.5	7.5 ⁴	7.5	7.5	T	T	T	T	T	T	T	T	T	T	T	T	T	T	T	
T	T	5	5 ⁴	5	6.5	9	T	T	T	T	T	T	T	T	T	T	T	T	T	T	
T	T		5 ⁴	5	6.5	8	T	T	T	T	T	T	T	T	T	T	T	T	T	T	
T	T		3 ⁴	5	6.5	8	T	T	T	T	T	T	T	T	T	T	T	T	T	T	
T	T				5	7.5	T	T	T	T	T	T	T	T	T	T	T	T	T	T	
T	T				5	7.5	T	T	T	T	T	T	T	T	T	T	T	T	T	T	
T	T				5 ⁴	7.5	T	T	T	T	T	T	T	T	T	T	T	T	T	T	
T	T					6.5	T	T	T	T	T	T	T	T	T	T	T	T	T	T	
T	T					5 ⁴	T	T	T	T	T	T	T	T	T	T	T	10.5	10.5	T	T
T	T						T ⁴	T ⁴	T	T	T	T	T	T	T	T	10.5	T	T	T	T

T3	T4												T5	T2				T4		T5	
B, C, N, S, H, L, V																					
TM													EL								
200	250	20	25	32	50	80	100	125	160	200	250	320÷500	10	25	63	100	160	100, 160	250, 320	320÷630	
T	T	T	T	T	T	T	T	T	T	T	T	T	T	T	T	T	T	T	T	T	T
T	T	T	T	T	T	T	T	T	T	T	T	T	T	T	T	T	T	T	T	T	T
T	T	T	T	T	T	T	T	T	T	T	T	T	T	T	T	T	T	T	T	T	T
T	T	7.5	7.5 ⁴	7.5	7.5	T	T	T	T	T	T	T	T	T	T	T	T	T	T	T	T
T	T	7.5	7.5 ⁴	7.5	7.5	T	T	T	T	T	T	T	T	T	T	T	T	T	T	T	T
T	T	5	5 ⁴	5	6.5	9	T	T	T	T	T	T	T	T	T	T	T	T	T	T	T
T	T		5 ⁴	5	6.5	8	T	T	T	T	T	T	T	T	T	T	T	T	T	T	T
T	T		3 ⁴	5	6.5	8	T	T	T	T	T	T	T	T	T	T	T	T	T	T	T
T	T				5	7.5	T	T	T	T	T	T	T	T	T	T	T	T	T	T	T
T	T				5	7.5	T	T	T	T	T	T	T	T	T	T	T	T	T	T	T
T	T				5 ⁴	7.5	T	T	T	T	T	T	T	T	T	T	T	T	T	T	T
T	T					6.5	T	T	T	T	T	T	T	T	T	T	T	T	T	T	T
T	T					5 ⁴	T	T	T	T	T	T	T	T	T	T	T	10.5	10.5	T	T
T	T						T	T	T	T	T	T	T	T	T	T	T	10.5	T	T	T
10	15								5	11	T	T	T	T	T	T	4	T	T	T	T
7.5 ³	15								5 ⁴	8	T	T	T	T	T	T	4	12 ⁴	T	T	T
7.5 ³									8 ⁴	12	T	T	T	T	T	T	4	T	T	T	T

System pro M compact®

Technical details

Coordination tables: selectivity

MCBs

MCCB - S2.. D @ 415 V

Char.	I _{cu} [kA]	Supply S.			T2	T1 - T2						T1 - T2 - T3					
		Version			B, C, N, S, H, L												
		Release			TM												
		10	15	25	I _n [A]	12.5	16	20	25	32	40	50	63	80	100	125	160
Load S.	D	S200	S200M	S200P	≤2	T	T	T	T	T	T	T	T	T	T	T	T
		S200	S200M	S200P	3	T	T	T	T	T	T	T	T	T	T	T	T
		S200	S200M	S200P	4	T	T	T	T	T	T	T	T	T	T	T	T
		S200	S200M	S200P	6	5.5 ¹	5.5	5.5	5.5	5.5	5.5	5.5	10.5	T	T	T	T
		S200	S200M	S200P	8			5.5	5.5	5.5	5.5	5.5	10.5	12	T	T	T
		S200	S200M	S200P	10			3 ¹	3	3	3	3	5	8.5	17	T	T
		S200	-	S200P	13					2 ¹	2	2	3	5	8	13.5	T
		S200	S200M	S200P	16					2 ¹	2	2	3	5	8	13.5	T
		S200	S200M	S200P	20					2 ¹		2	3	4.5	6.5	11	T
		S200	S200M	S200P	25						2 ¹	2.5	4	6	9.5	T	
		S200	S200M-S200P	-	32								4	6	9.5	T	
		S200	S200M-S200P	-	40								3 ¹	5	8	T	
		S200	S200M-S200P	-	50								2 ¹	3 ²	5	9.5	
		S200	S200M-S200P	-	63									3 ²	5 ³	9.5	
		-	S290	-	80												4 ³
		-	S290	-	100												4 ³
-	-	-	125														

- ¹ Value valid only for T2 magnetic only supply side circuit-breaker
- ² Value valid only for T2-T3 magnetic only supply side circuit-breaker
- ³ Value valid only for T3 magnetic only supply side circuit-breaker
- ⁴ Value valid only for T4 magnetic only supply side circuit-breaker
- ⁵ Value valid only for T4 In 160 magnetic only supply side circuit-breaker

MCCB - S2.. K @ 415 V

Char.	I _{cu} [kA]	Supply S.			T2	T1 - T2						T1 - T2 - T3					
		Version			B, C, N, S, H, L												
		Release			TM												
		10	15	25	I _n [A]	12.5	16	20	25	32	40	50	63	80	100	125	160
Load S.	K	S200	S200M	S200P	≤2	T	T	T	T	T	T	T	T	T	T	T	T
		S200	S200M	S200P	3	T	T	T	T	T	T	T	T	T	T	T	T
		S200	S200M	S200P	4	T	T	T	T	T	T	T	T	T	T	T	T
		S200	S200M	S200P	6	5.5 ¹	5.5	5.5	5.5	5.5	5.5	5.5	10.5	T	T	T	T
		S200	S200M	S200P	8			5.5	5.5	5.5	5.5	5.5	10.5	12	T	T	T
		S200	S200M	S200P	10			3 ¹	3	3	3	3	6	8.5	17	T	T
		-	-	S200P	13					2 ¹	3	3	5	7.5	10	13.5	T
		S200	S200M	S200P	16					2 ¹	3	3	4.5	7.5	10	13.5	T
		S200	S200M	S200P	20					2 ¹		3	3.5	5.5	6.5	11	T
		S200	S200M	S200P	25						2 ¹	3.5	5.5	6	9.5	T	
		S200	S200M-S200P	-	32								4.5	6	9.5	T	
		S200	S200M-S200P	-	40								3 ¹	5	8	T	
		S200	S200M-S200P	-	50								2 ¹	3 ²	6	9.5	
		S200	S200M-S200P	-	63									3 ²	5.5 ³	9.5	
		-	S290	-	80												4 ³
		-	S290	-	100												4 ³
-	-	-	125														

- ¹ Value valid only for T2 magnetic only supply side circuit-breaker
- ² Value valid only for T2-T3 magnetic only supply side circuit-breaker
- ³ Value valid only for T3 magnetic only supply side circuit-breaker
- ⁴ Value valid only for T4 magnetic only supply side circuit-breaker
- ⁵ Value valid only for T4 In 160 magnetic only supply side circuit-breaker

11

T3	T4												T5	T2				T4		T5	
B, C, N, S, H, L, V																					
TM													EL								
200	250	20	25	32	50	80	100	125	160	200	250	320÷500	10	25	63	100	160	100, 160	250, 320	320÷630	
T	T	T	T	T	T	T	T	T	T	T	T	T	T	T	T	T	T	T	T	T	
T	T	T	T	T	T	T	T	T	T	T	T	T	T	T	T	T	T	T	T	T	
T	T	T	T	T	T	T	T	T	T	T	T	T	T	T	T	T	T	T	T	T	
T	T	7.5	7.5 ⁴	7.5	7.5	T	T	T	T	T	T	T	T	T	T	T	T	T	T	T	
T	T	7.5	7.5 ⁴	7.5	7.5	T	T	T	T	T	T	T	T	T	T	T	T	T	T	T	
T	T	5	5 ⁴	5	5	9	T	T	T	T	T	T	T	T	T	T	T	T	T	T	
T	T		5 ⁴		4	5.5	T	T	T	T	T	T	T	T	T	T	T	T	T	T	
T	T				4	5.5	T	T	T	T	T	T	T	T	T	T	T	T	T	T	
T	T				4 ⁴	5	T	T	T	T	T	T	T	T	T	T	T	T	T	T	
T	T				4 ⁴	4.5	T	T	T	T	T	T	T	T	T	T	T	T	T	T	
T	T					4.5 ⁴	T	T	T	T	T	T	T	T	T	T	T	T	T	T	
T	T					4.5 ⁴	T	T	T	T	T	T	T	T	T	T	T	T	T	T	
T	T						T	T	T	T	T	T	T	T	T	9.5	9.5	T	T	T	
T	T							T	T	T	T	T	T	T	T		9.5	T	T	T	
10	15								5	11	T	T					4	T	T	T	
7.5 ³	15									8	T	T					4	12 ⁵	T	T	

T3	T4												T5	T2				T4		T5	
B, C, N, S, H, L, V																					
TM													EL								
200	250	20	25	32	50	80	100	125	160	200	250	320÷500	10	25	63	100	160	100, 160	250, 320	320÷630	
T	T	T	T ⁴	T	T	T	T	T	T	T	T	T	T	T	T	T	T	T	T	T	
T	T	T	T ⁴	T	T	T	T	T	T	T	T	T	T	T	T	T	T	T	T	T	
T	T	T	T ⁴	T	T	T	T	T	T	T	T	T	T	T	T	T	T	T	T	T	
T	T	7.5	7.5 ⁴	7.5	7.5	T	T	T	T	T	T	T	T	T	T	T	T	T	T	T	
T	T	7.5	7.5 ⁴	7.5	7.5	T	T	T	T	T	T	T	T	T	T	T	T	T	T	T	
T	T		5 ⁴	5	5	9	T	T	T	T	T	T	T	T	T	T	T	T	T	T	
T	T		5 ⁴	5	5	8	T	T	T	T	T	T	T	T	T	T	T	T	T	T	
T	T		5 ⁴		5	8	T	T	T	T	T	T	T	T	T	T	T	T	T	T	
T	T				5	6	T	T	T	T	T	T	T	T	T	T	T	T	T	T	
T	T				5 ⁴	6 ⁴	T	T	T	T	T	T	T	T	T	T	T	T	T	T	
T	T				5 ⁴	6 ⁴	T ⁴	T	T	T	T	T	T	T	T	T	T	T	T	T	
T	T					5.5 ⁴	T ⁴	T ⁴	T	T	T	T	T	T	T	T	T	T	T	T	
T	T					5 ⁴	T ⁴	T ⁴	T ⁴	T	T	T	T	T	T	9.5	9.5	T	T	T	
T	T						T ⁴	T ⁴	T ⁴	T ⁴	T	T	T	T	T		9.5	T	T	T	
10	15								5	11	T	T					4	T ⁵	T	T	
7.5 ³	15								5 ⁴	8	T	T					4	12 ⁵	T	T	

MCCB - S2.. Z @ 415 V

Char.	I _{cu} [kA]	Supply S.			T2	T1 - T2							T1 - T2 - T3				
		10	15	25	Version	B, C, N, S, H, L											
		Release			TM												
		I _n [A]	12.5	16	20	25	32	40	50	63	80	100	125	160			
Load S.	Z	S200	-	S200P	≤2	T	T	T	T	T	T	T	T	T	T	T	T
		S200	-	S200P	3	T	T	T	T	T	T	T	T	T	T	T	T
		S200	-	S200P	4	T	T	T	T	T	T	T	T	T	T	T	T
		S200	-	S200P	6	5.5 ¹	5.5	5.5	5.5	5.5	5.5	5.5	10.5	T	T	T	T
		S200	-	S200P	8			5.5	5.5	5.5	5.5	5.5	10.5	T	T	T	T
		S200	-	S200P	10			3 ¹	3	3	3	4.5	8	8.5	17	T	T
		-	-	S200P	13			3 ¹		3	3	4.5	7.5	7.5	12	20	T
		S200	-	S200P	16					3 ¹	3	4.5	5	7.5	12	20	T
		S200	-	S200P	20					3 ¹		3	5	6	10	15	T
		S200	-	S200P	25							3 ¹	5	6	10	15	T
		S200	S200P	-	32							3 ¹		6	7.5	12	T
		S200	S200P	-	40									5.5 ¹	7.5	12	T
		S200	S200P	-	50									4 ¹	5 ²	7.5	10.5
		S200	S200P	-	63										5 ²	6 ³	10.5
		-	-	-	80												
		-	-	-	100												
-	-	-	125														

¹ Value valid only for T2 magnetic only supply side circuit-breaker
² Value valid only for T2-T3 magnetic only supply side circuit-breaker
³ Value valid only for T3 magnetic only supply side circuit-breaker
⁴ Value valid only for T4 magnetic only supply side circuit-breaker

MCCB - S 290 @ 415 V

400V				Supply s.	T2		
				Version	N-S-H-L		
				Relay	TM-M		EL
				I _u [A]	160		160
Load S.	Char.	I _{cu} [kA]	I _n [A]	160		160	
S 290	C-D	20*	80			4	
			100			4	
	C	20*	125			4	

* 15 kA for D characteristic.

400V				Supply s.	T3		
				Version	N-S		
				Relay	TM-M		
				I _u [A]	250		
Load S.	Char.	I _{cu} [kA]	I _n [A]	160	200	250	
S 290	C-D	20*	80	4**	10	15	
			100	4**	7.5**	15	
			125		7.5**		

* 15 kA for D characteristic.
** Value valid with supply side magnetic only circuit-breaker.

System pro M compact®

Technical details

Coordination tables: selectivity

MCBs

T3	T4												T5	T2				T4		T5
B, C, N, S, H, L, V																				
TM												EL								
200	250	20	25	32	50	80	100	125	160	200	250	320÷500	10	25	63	100	160	100, 160	250, 320	320÷630
T	T	T	T	T	T	T	T	T	T	T	T	T	T	T	T	T	T	T	T	T
T	T	T	T	T	T	T	T	T	T	T	T	T	T	T	T	T	T	T	T	T
T	T	T	T	T	T	T	T	T	T	T	T	T	T	T	T	T	T	T	T	T
T	T	7.5	7.5 ⁴	7.5	7.5	T	T	T	T	T	T	T	T	T	T	T	T	T	T	T
T	T	7.5	7.5 ⁴	7.5	7.5	T	T	T	T	T	T	T	T	T	T	T	T	T	T	T
T	T	5	5 ⁴	5	6.5	9	T	T	T	T	T	T	T	T	T	T	T	T	T	T
T	T		5 ⁴	5	6.5	8	T	T	T	T	T	T	T	T	T	T	T	T	T	T
T	T		5 ⁴	4.5	6.5	8	T	T	T	T	T	T	T	T	T	T	T	T	T	T
T	T				5	6.5	T	T	T	T	T	T	T	T	T	T	T	T	T	T
T	T				5	6.5	T	T	T	T	T	T	T	T	T	T	T	T	T	T
T	T				5 ⁴	6.5	T	T	T	T	T	T	T	T	T	T	T	T	T	T
T	T					5	T	T	T	T	T	T	T	T	T	T	T	T	T	T
T	T					3.5 ⁴	T	T	T	T	T	T	T	T	T	T	T	T	T	T
T	T						T	T	T	T	T	T	T	T	T	T	T	T	T	T

MCCB - S800 @ 415 V

Load S.	Char.	I _{cu} [kA]	Supply S.	T1										T1 - T3			T1	T3	
			Version	B, C, N, S, H, L, V															
			Release	TM															
			I _n [A]	16	20	25	32	40	50	63	80	100	125	160	160	200	250		
S800N	B C D	36	10			4.5	4.5	4.5	4.5	8	10	20 ¹	25 ¹	T	T	T	T		
			13			4.5	4.5	4.5	7.5	10	15	25 ¹	T	T	T	T			
			16				4.5	4.5	7.5	10	15	25 ¹	T	T	T	T			
			20					4.5	7.5	10	15	25 ¹	T	T	T	T			
			25						6	10	15	20 ¹	T	T	T	T			
			32							7.5	10	20 ¹	T	T	T	T			
			40								10	20 ¹	T	T	T	T			
			50									15	T	T	T	T			
			63										T	T	T	T			
			80											T		T	T		
S800S	B C D K	50	10			4.5	4.5	4.5	4.5	8	10	20 ¹	25 ¹	36 ¹	36 ¹	36 ¹	T		
			13				4.5	4.5	4.5	7.5	10	15	25 ¹	36 ¹	36 ¹	36 ¹	T		
			16					4.5	4.5	7.5	10	15	25 ¹	36 ¹	36 ¹	36 ¹	T		
			20						4.5	7.5	10	15	25 ¹	36 ¹	36 ¹	36 ¹	T		
			25							6	10	15	20 ¹	36 ¹	36 ¹	36 ¹	T		
			32								7.5	10	20 ¹	36 ¹	36 ¹	36 ¹	T		
			40									10	20 ¹	36 ¹	36 ¹	36 ¹	T		
			50										15	36 ¹	36 ¹	36 ¹	T		
			63											36 ¹	36 ¹	36 ¹	T		
			80												36 ¹		36 ¹	T	
100												36 ¹			T				
125															T				

¹ Select the lowest value between what is indicated and the breaking capacity of the supply side circuit-breaker

MCCB-S800 @ 415 V

Load S.	Char.	I _{cu} [kA]	I _n [A]	T4									T4 - T5		
				N, S, H, L, V											
				TM											EL
				20	25	32	50	80	100	125	160	200÷250	100÷630		
S800N/S	B	36-50	10	6.5	6.5 ¹	6.5	6.5	11	T	T	T	T	T	T	
			13	6.5	5 ¹	6.5	6.5	11	T	T	T	T	T	T	
			16		5 ¹	6.5	6.5	11	T	T	T	T	T	T	
			20		4 ¹	6.5	6.5	11	T	T	T	T	T	T	
			25				6.5	11	T	T	T	T	T	T	
			32				6.5	8	T	T	T	T	T	T	
			40				5 ¹	6.5	T	T	T	T	T	T	
			50					5 ¹	7.5	T	T	T	T	T	
			63						5 ¹	7	T	T	T	T	
			80								T	T	T	T	
			100									T	T	T	
			125											T	
	C	36-50	10	6.5	6.5 ¹	6.5	6.5	11	T	T	T	T	T	T	
			13	6.5	5 ¹	6.5	6.5	11	T	T	T	T	T	T	
			16		5 ¹	6.5	6.5	11	T	T	T	T	T	T	
			20		4 ¹	6.5	6.5	11	T	T	T	T	T	T	
			25		4 ¹		6.5	11	T	T	T	T	T	T	
			32				6.5	8	T	T	T	T	T	T	
			40				5 ¹	6.5	T	T	T	T	T	T	
			50				4 ¹	5 ¹	7.5	T	T	T	T	T	
			63					4 ¹	6.5 ¹	7	T	T	T	T	
			80					4 ¹	5 ¹	6.5 ¹	6.5	T	T	T	
			100						4 ¹	5 ¹	5 ¹	6.5	T	T	
			125							4 ¹	4 ¹	5 ¹	T		
	D	36-50	10	6.5	6.5 ¹	6.5	6.5	11	T	T	T	T	T	T	
			13		5 ¹		6.5	11	T	T	T	T	T	T	
			16				6.5	11	T	T	T	T	T	T	
			20				6.5 ¹	11	T	T	T	T	T	T	
			25				6.5 ¹	11	T	T	T	T	T	T	
			32					8 ¹	T	T	T	T	T	T	
			40					6.5 ¹	T	T	T	T	T	T	
			50						7.5 ¹	T	T	T	T	T	
			63							7 ¹	T	T	T	T	
			80								5 ¹	T	T	T	
			100									5 ¹	T	T	
			125										T		
	K	36-50	10		6.5 ¹	6.5	6.5	11	T	T	T	T	T	T	
			13		5 ¹	5	6.5	11	T	T	T	T	T	T	
			16		5 ¹		6.5	11	T	T	T	T	T	T	
			20		4 ¹		6.5	11	T	T	T	T	T	T	
			25				6.5 ¹	11 ¹	T	T	T	T	T	T	
			32				5 ¹	8 ¹	T	T	T	T	T	T	
			40					6.5 ¹	T	T	T	T	T	T	
			50					5 ¹	7.5 ¹	T	T	T	T	T	
			63					4 ¹	6.5 ¹	7 ¹	T	T	T	T	
			80						5 ¹	6.5 ¹	7 ¹	T	T	T	
			100							5 ¹	6.5 ¹	7 ¹	T	T	
			125								5 ¹	6.5 ¹	T		

¹ Value valid only for magnetic only supply side circuit-breaker (with I_n = 50 A, please consider MA52 circuit-breakers)

² For T4 I_n = 100 A, value valid only for magnetic only supply side circuit-breaker

³ For T4 I_n = 160 A, value valid only for magnetic only supply side circuit-breaker

**MCBs internal resistance, power loss
and max. permissible earth-fault loop impedance**

Internal resistance and power loss of the miniature circuit-breakers

Internal resistance per pole in mΩ, power loss per pole in W

Type	Rated current	Device series B, C, D *	
	I _n A	mΩ	W
SN201 L	2	520	2.1
SN201	4	147.5	2.4
SN201 M	6	64	2.3
	10	19	1.9
	16	14	3.6
	20	12	4.8
	25	7,1	4.4
	32	6,5	6.7
	40	4,7	7.5

* Total power loss

Type	Rated current	Device series B, C, D ①		K mΩ	W	Z	
	I _n A	mΩ	W			mΩ	W
S 200 and S 200 M	0.5	5500	1.4	6340	1.6	10100	2.5
	1	1440	1.4	1550	1.6	2270	2.3
	1.6	630	1.6	695	1.8	1100	2.8
	2	460	1.8	460	1.9	619	2.5
	3	150	1.3	165	1.5	202	1.8
	4	110	1.8	120	2.0	149	2.4
	6	55	2.0	52	1.9	104	3.7
	8	15	1.0	38	2.5	53.9	3.45
	10	13.3	1.3	12.6	1.26	17.5	1.7
	13	13.3	2.3	12.6	2.1	–	–
	16	7.0	1.8	7.7	2.0	10.9	2.8
	20	6.25	2.5	6.7	2.7	6.0	2.4
	25	5.0	3.2	4.6	2.9	4.1	2.6
	32	3.6	3.7	3.5	3.6	2.8	2.9
	40	3.0	4.8	2.8	4.5	2.5	4.1
	50	1.3	3.25	1.25	3.1	1.8	4.4
	63	1.2	4.8	0.7	2.8	1.3	5.2

① Current intensities 0.5 – 4 apply exclusively to C-type trip characteristics.

Internal resistances are subject to application-specific and environment-specific conditions and are therefore to be considered as typical values.

Type	Rated current	R _i	P _{vmax}	Type	R _i	P _{vmax}
	A	mΩ	W		mΩ	W
S 700-E	10	38.0	4.9	S 700-K		
	16	15.5	5.2		10.5	3.1
	20	12.5	6.5		7.5	3.8
	25	7.4	6.5		5.7	3.9
	32	5.3	7.2			
	35	4.0	7.6		4.7	7.8
	40	4.0	8.0		3.8	6.8
	50	2.9	9.5		3.0	10.0
	63	2.0	9.9		2.0	9.6
	80	1.5	13.5		1.3	10.1
	100	1.0	14.4		1.1	12.3

Maximum permissible earth-fault loop impedance Z_S at $U_0 = 230 \text{ V} \sim$ ②
to ensure compliance with the operation conditions pursuant to IEC 60364-4.

Operating time < 0.4 s; at 400 V~ < 0.2 s and at > 400 V~ < 0.1 s

The instantaneous release of the MCB ensures an operating time of $\leq 0.1 \text{ s}$ (TN system).

Determined according to DIN VDE 0100-520 sheet 2:2002-11 (source impedance = 300 mΩ, c = 0.95 and conductor temperature 70 °C = factor 0.8). The internal resistance of the MCB is already included.

S 200 and S 200 M

Rated current I_n A	B max. Z_S Ω	C max. Z_S Ω	D max. Z_S Ω	K max. Z_S Ω	Z max. Z_S Ω
0.5	–	46	33.0	33.0	153.3
1	–	23	16.5	16.5	76.7
1.6	–	14.4	10.3	10.3	47.9
2	–	11.5	8.2	8.2	38.3
3	–	7.7	5.5	5.5	25.6
4	–	5.8	4.1	4.1	19.2
6	7.7	3.8	2.7	2.7	12.8
8	–	2.8	2.1	2.1	9.5
10	4.6	2.2	1.6	1.6	7.7
13	3.5	1.7	1.2	1.2	–
16	2.9	1.4	1.0	1.0	4.8
20	2.3	1.2	0.8	0.8	3.8
25	1.8	0.9	0.7	0.7	3.1
32	1.4	0.7	0.5	0.5	2.4
40	1.1	0.6	0.4	0.4	1.9
50	0.9	0.5	0.3	0.3	1.5
63	0.7	0.4	0.3	0.3	1.2

② U_0 = rated voltage against earthed conductor; for $U_0 = 240 \text{ V} \sim$ is $Z_S \cdot 1.04$; for $U_0 = 127 \text{ V} \sim$ is $Z_S \cdot 0.55$

Take into account the voltage drop:

e.g. in the case of a 1.5 mm² conductor, protected by a B 16 circuit-breaker, the maximum cable length is 82 m. If the voltage drop is below 3%, this would result in a maximum cable length (2-strand) of 17 m. For more details on this topic, get your own copy of the technical information leaflet "Maximum cable lengths".

Maximum cable lengths in the case of different voltages and cross sections on request.

Internal resistance and power loss of the miniature circuit-breakers

Internal resistance per pole in mΩ, power loss per pole in W

Type	Rated current I_n A	Device series B, C, D ①		K		Z	
		mΩ	W	mΩ	W	mΩ	W
S 200 P	0.2	–	–	42500	1.7	–	–
	0.3	–	–	20000	1.8	–	–
	0.5	5500	1.4	6340	1.6	10100	2.5
	0.75	–	–	2500	1.4	–	–
	1	1440	1.4	1400	1.4	2270	2.3
	1.6	630	1.6	625	1.6	1100	2.8
	2	460	1.8	460	1.8	619	2.5
	3	211	1.9	211	1.9	211	1.9
	4	150	2.4	163	2.6	163	2.6
	6	61	2.2	67	2.4	104	3.7
	8	45	2.9	45	2.9	55	3.5
	10	14	1.4	19	1.9	21	2.1
	13	13.3	2.3	–	–	–	–
	16	9.7	2.5	8.2	2.1	10.9	2.8
	20	7.3	2.9	7.3	2.9	7.3	2.9
	25	5.6	3.5	5.6	3.5	5.6	3.5
	32	4.1	4.2	4.1	4.2	4.1	4.2
	40	4.0	6.4	4.0	6.4	4.0	6.4
	50	1.2	3.0	1.2	3.0	1.8	4.4
	63	1.4	5.6	1.3	5.2	1.3	5.2

① Current intensities 0.5 – 4 apply exclusively to C-type trip characteristics.

Internal resistances are subject to application-specific and environment-specific conditions and are therefore to be considered as typical values.

**Maximum permissible earth-fault loop impedance Z_S at $U_0 = 230 \text{ V} \sim$ ②
to ensure compliance with the operation conditions pursuant to IEC 60364-4.
Operating time < 0.4 s; at 400 V~ < 0.2 s and at > 400 V~ < 0.1 s
The instantaneous release of the MCB ensures an operating time of $\leq 0.1 \text{ s}$ (TN system).**

Determined according to DIN VDE 0100-520 sheet 2:2002-11 (source impedance = 300 m Ω , c = 0.95 and conductor temperature 70 °C = factor 0.8). The internal resistance of the MCB is already included.

S 200 P

Rated current I_n A	B max. Z_S Ω	C max. Z_S Ω	D max. Z_S Ω	K max. Z_S Ω	Z max. Z_S Ω
0.2	–	–	–	40	–
0.3	–	–	–	34.8	–
0.5	–	46	27.4	26.5	143
0.75	–	–	–	19.4	–
1	–	23	15	15	74.4
1.6	–	14.4	9.6	9.6	47.9
2	–	11.5	7.8	7.8	38.3
3	–	7.7	11.8	5.3	25.3
4	–	5.8	8.8	4.1	19.1
6	7.6	3.8	5.9	2.7	12.7
8	–	2.8	5.7	2.0	9.5
10	4.6	2.3	3.5	1.6	7.6
13	3.5	1.7	2.7	–	–
16	2.9	1.4	2.2	1.0	4.7
20	2.3	1.1	1.7	0.8	3.8
25	1.8	0.9	1.4	0.6	3.0
32	1.4	0.7	1.1	0.5	2.4
40	1.1	0.6	0.9	0.4	1.9
50	0.9	0.5	0.7	0.3	1.5
63	0.7	0.4	0.6	0.25	1.1

② U_0 = rated voltage against earthed conductor; for $U_0 = 240 \text{ V} \sim$ is $Z_S \cdot 1.04$; for $U_0 = 127 \text{ V} \sim$ is $Z_S \cdot 0.55$

Take into account the voltage drop (see the previous page)

Internal resistance and power loss

Internal resistance in m Ω per pole in cold state, power loss in W per pole at rated current

Type	Rated current A	R_l m Ω	P_{vmax} W	Type	R_l m Ω	P_{vmax} W
S 700-E	10	38.0	4.9	S 700-K		
	16	15.5	5.2		10.5	3.1
	20	12.5	6.5		7.5	3.8
	25	7.4	6.5		5.7	3.9
	32	5.3	7.2			
	35	4.0	7.6		4.7	7.8
	40	4.0	8.0		3.8	6.8
	50	2.9	9.5		3.0	10.0
	63	2.0	9.9		2.0	9.6
	80	1.5	13.5		1.3	10.1
	100	1.0	14.4	1.1	12.3	

Derating of load capability of MCBs

Derating of MCBs load capability takes in consideration 3 factors:

- ambient temperature
- continuity (duration) of the load
- influence of adjacent devices

The rules to obtain the effective value of I_n are the following:

1. Deviating ambient temperature:

The rated value of the current of a miniature circuit-breaker refers to a temperature of 20 °C for circuit-breakers with characteristics K and Z and 30 °C for characteristics B, C and D.

The following tables contain the derating of load capability of S 200/M/P MCBs* with temperature from -40 °C to 70 °C for the curves B, C, D and K, Z.

S200, DS200 and DS271 ①

Max. operating current depending on the ambient temperature of a circuit-breaker in load circuit of characteristics type B, C and D

B, C and D In (A)	Ambient temperature T (°C)											
	- 40	- 30	- 20	- 10	0	10	20	30	40	50	60	70
0.5	0.67	0.65	0.62	0.60	0.58	0.55	0.53	0.50	0.47	0.44	0.41	0.37
1.0	1.33	1.29	1.25	1.20	1.15	1.11	1.05	1.00	0.94	0.88	0.82	0.75
1.6	2.13	2.07	2.00	1.92	1.85	1.77	1.69	1.60	1.51	1.41	1.31	1.19
2.0	2.67	2.58	2.49	2.40	2.31	2.21	2.11	2.00	1.89	1.76	1.63	1.49
3.0	4.0	3.9	3.7	3.6	3.5	3.3	3.2	3.0	2.8	2.6	2.4	2.2
4.0	5.3	5.2	5.0	4.8	4.6	4.4	4.2	4.0	3.8	3.5	3.3	3.0
6.0	8.0	7.7	7.5	7.2	6.9	6.6	6.3	6.0	5.7	5.3	4.9	4.5
8.0	10.7	10.3	10.0	9.6	9.2	8.8	8.4	8.0	7.5	7.1	6.5	6.0
10.0	13.3	12.9	12.5	12.0	11.5	11.1	10.5	10.0	9.4	8.8	8.2	7.5
13.0	17.3	16.8	16.2	15.6	15.0	14.4	13.7	13.0	12.3	11.5	10.6	9.7
16.0	21.3	20.7	20.0	19.2	18.5	17.7	16.9	16.0	15.1	14.1	13.1	11.9
20.0	26.7	25.8	24.9	24.0	23.1	22.1	21.1	20.0	18.9	17.6	16.3	14.9
25.0	33.3	32.3	31.2	30.0	28.9	27.6	26.4	25.0	23.6	22.0	20.4	18.6
32.0	42.7	41.3	39.9	38.5	37.0	35.4	33.7	32.0	30.2	28.2	26.1	23.9
40.0	53.3	51.6	49.9	48.1	46.2	44.2	42.2	40.0	37.7	35.3	32.7	29.8
50.0	66.7	64.5	62.4	60.1	57.7	55.3	52.7	50.0	47.1	44.1	40.8	37.3
63.0	84.0	81.3	78.6	75.7	72.7	69.6	66.4	63.0	59.4	55.6	51.4	47.0
80.0	112.6	107.2	102.1	97.2	92.6	88.2	84.0	80.0	76.0	72.2	68.6	65.2
100.0	140.7	134.0	127.6	121.6	115.8	110.3	105.0	100.0	95.0	90.3	85.7	81.5
125.0	175.9	167.5	159.5	151.9	144.7	137.8	131.3	125.0	118.8	112.8	107.2	101.8

① DS271 where In available. Ambient temperature -25...+55°C

S200 and DS200

Max. operating current depending on the ambient temperature of a circuit-breaker in load circuit of characteristics type K and Z

K and Z In (A)	Ambient temperature T (°C)											
	- 40	- 30	- 20	- 10	0	10	20	30	40	50	60	70
0.5	0.66	0.64	0.61	0.59	0.56	0.53	0.50	0.47	0.43	0.40	0.35	0.31
1.0	1.32	1.27	1.22	1.17	1.12	1.06	1.00	0.94	0.87	0.79	0.71	0.61
1.6	2.12	2.04	1.96	1.88	1.79	1.70	1.60	1.50	1.39	1.26	1.13	0.98
2.0	2.65	2.55	2.45	2.35	2.24	2.12	2.00	1.87	1.73	1.58	1.41	1.22
3.0	4.0	3.8	3.7	3.5	3.4	3.2	3.0	2.8	2.6	2.4	2.1	1.8
4.0	5.3	5.1	4.9	4.7	4.5	4.2	4.0	3.7	3.5	3.2	2.8	2.4
6.0	7.9	7.6	7.3	7.0	6.7	6.4	6.0	5.6	5.2	4.7	4.2	3.7
8.0	10.8	10.2	9.8	9.4	8.9	8.5	8.0	7.5	6.9	6.3	5.7	4.9
10.0	13.2	12.7	12.2	11.7	11.2	10.6	10.0	9.4	8.7	7.9	7.1	6.1
13.0	17.2	16.6	15.9	15.2	14.5	13.8	13.0	12.2	11.3	10.3	9.2	8.0
16.0	21.2	20.4	19.6	18.8	17.9	17.0	16.0	15.0	13.9	12.6	11.3	9.8
20.0	26.5	25.5	24.5	23.5	22.4	21.2	20.0	18.7	17.3	15.8	14.1	12.2
25.0	33.1	31.9	30.6	29.3	28.0	26.5	25.0	23.4	21.7	19.8	17.7	15.3
32.0	42.3	40.8	39.2	37.5	35.8	33.9	32.0	29.9	27.7	25.3	22.6	19.6
40.0	52.9	51.0	49.0	46.9	44.7	42.4	40.0	37.4	34.6	31.6	28.3	24.5
50.0	66.1	63.7	61.2	58.6	55.9	53.0	50.0	46.8	43.3	39.5	35.4	30.6
63.0	83.3	80.3	77.2	73.9	70.4	66.8	63.0	58.9	54.6	49.8	44.5	38.6

DS201 and DS202C

Max. operating current depending on the ambient temperature of a circuit-breaker in load circuit of characteristics type B, C and D

B, C and D	Ambient temperature T (°C)											
	-30	-20	-10	0	10	20	30	40	50	60	70	
In (A)												
4	5.0	4.8	4.6	4.5	4.3	4.2	4	3.8	3.7	3.5	3.4	
6	8.1	7.8	7.4	7.1	6.7	6.4	6	5.6	5.3	4.9	4.6	
8	10.5	10.1	9.7	9.3	8.8	8.4	8	7.6	7.2	6.7	6.3	
10	12.0	11.6	11.3	11.0	10.7	10.3	10	9.7	9.3	9.0	8.7	
13	15.9	15.4	14.9	14.4	14.0	13.5	13	12.5	12.0	11.6	11.1	
16	18.9	18.4	17.9	17.4	17.0	16.5	16	15.5	15.0	14.6	14.1	
20	23.4	22.8	22.2	21.7	21.1	20.6	20	19.4	18.9	18.3	17.8	
25	31.3	30.3	29.2	28.2	27.1	26.1	25	23.9	22.9	21.8	20.8	
32	40.0	38.6	37.3	36.0	34.7	33.3	32	30.7	29.3	28.0	26.7	
40	51.7	49.7	47.8	45.8	43.9	41.9	40	38.1	36.1	34.2	32.2	

2. Multiply the rated current (equivalent) referring to the new temperature by another factor only in case of presence of several devices installed alongside each other; see table.

Influence of adjacent devices S200

OEPM0108

Influence of adjacent devices
Correction factor Fm

No. of adjacent devices	Fm
1	1
2	0.95
3	0.9
4	0.86
5	0.82
6	0.795
7	0.78
8	0.77
9	0.76
>9	0.76

Example: S 202 C 16 with T=40 °C

Type of use	Values to use	Formula	Calculation	Result
Load at ambient temperature	In (amb. t°) -see tables-			In=15.1 A
Load at ambient temperature with 8 adj. devices	In (amb. t°) -see tables- Fm (0.77)	In (amb. t°)x0.77	15.1x0.77	In=11.63 A

Influence of adjacent devices DS201 and DS202C

OEPM0108

Influence of adjacent devices
Correction factor Fm

No. of adjacent devices	Fm
1	1.00
2	0.95
3	0.91
4	0.88
5	0.87
6	0.86
7	0.85
> 7	0.85
9	0.85

Use of S 200/S 200 M/S 200 P miniature circuit-breakers in direct current circuits 72 VDC/125 VDC

In DC systems up to 72 VDC or, as the case may be, series connection up to 125 VDC, customary S 200/S 200 M series MCBs can be used. Polarity does not need to be taken into consideration, the outgoing circuit may be implemented from above or below the device.
For higher direct voltage up to 440 VDC devices of the S 280 UC series must be used.

Example for max. permissible voltages between conductors depending on the number of poles and type of connection.

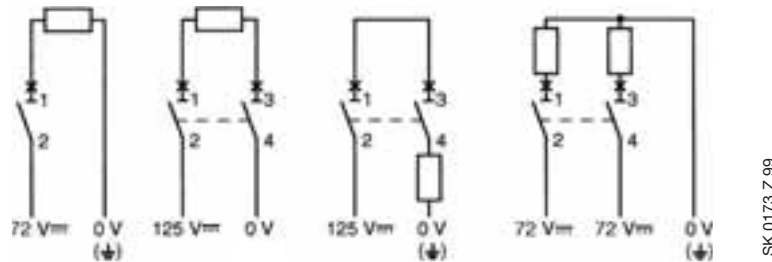

Examples for different voltages between a conductor and earth where voltages between conductors are identical:

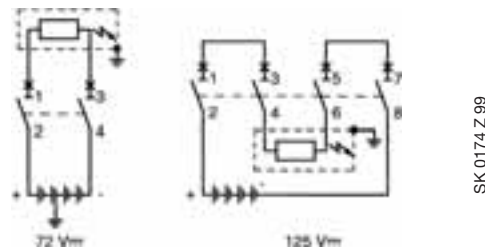

Performance in altitude of MCBs

Up to the height of 2000 m, MCBs do not undergo any alterations in their rated performances. Over this height the properties of the atmosphere change in terms of composition, dielectric capacity, cooling capacity and pressure, therefore the performances of the MCBs undergo derating, which can basically be measured in terms of variations in significant parameters, such as the maximum operating voltage and the rated current.

S 200/M/P

Altitude[m]	2000	3000	4000
Rated service voltage $U_e[V]$	440	380	380
Rated current I_n	I_n	$0.96 \times I_n$	$0.93 \times I_n$

Variation of tripping thresholds of MCBs according to network frequency

The circuit-breakers are calibrated for a current with a frequency range between 50 and 60 Hz.

For other frequency values, the electro-magnetic tripping current varies according to the multiplication factor H.

	D.C.	100 Hz	200Hz	400Hz
H	1.5	1.1	1.2	1.5

For the thermal trip, on the other hand, there is no variation because it is independent of the network frequency.

Example:

S 202 C10 supplied at 50-60 Hz, the electro-magnetic tripping current is: $50 A \leq I_m \leq 100 A$;
S 202 C10 supplied at 400 Hz, the electro-magnetic tripping current is: $75 A \leq I_m \leq 150 A$.

Lighting circuit protection

Selection of circuit-breakers for the protection of lighting circuit and calculation of their rated current

To select the correct circuit-breaker for use in the protection of lighting circuits you need to know the type of load based on which you will work out the breaker's rated current. The protection circuit utilization current can be calculated simply starting with the rated power and the lighting voltage, or it may be supplied directly by the device manufacturer.

Considering the utilization current, it is important to select the version of the breaker with a rated current just above the value calculated, defining the cable cross-section accordingly.

The tables below show the rated current values of the circuit-breakers to be used according to the type and power of the device connected.

Table 1 High pressure discharge lamps

230 V and 400 VAC three-phase with or without power factor correcting capacitors, star or delta connection

Mercury vapour fluorescent lamp	Pw [W]	<700	<1000	<2000
	I [A]	6	10	16
Mercury vapour metal halogen lamp	Pw [W]	<375	<1000	<2000
	I [A]	6	10	16
High pressure sodium discharge lamp	Pw [W]	<400		<1000
	I [A]	6		16

Table 2 Fluorescent lamps

230 VAC single-phase/three-phase with neutral (400 V), with star connection.

The tables indicate the rated current of the circuit-breakers according to the lamp power and type of power supply.

Example of calculation

- Starter dissipated power: 25% of lamp power
- Reference temperature: 30 and 40 °C according to circuit-breaker
- Power factor: lamp without capacitors $\cos\phi=0.6$
lamp with capacitors $\cos\phi=0.86$

Method of calculation

- $IB = (PL * n^{\circ}L * KST * KC) / (Un * \cos\phi)$ where:
 - Un = rated voltage 230 V
 - $\cos\phi$ = power factor
 - PL = lamp power
 - $n^{\circ}L$ = number of lamps per phase
 - KST = 1.25
 - KC = 1 for star connection and 1.732 for delta connection

Type of lamp	Tube diss. pwr. [W]	Number of lamps per phase													
Single without capacitors	18	4	9	14	29	49	78	98	122	157	196	245	309	392	490
	36	2	4	7	14	24	39	49	61	78	98	122	154	196	245
	58	1	3	4	9	15	24	30	38	48	60	76	95	121	152
Single with capacitors	18	7	14	21	42	70	112	140	175	225	281	351	443	562	703
	36	3	7	10	21	35	56	70	87	112	140	175	221	281	351
	58	2	4	6	13	21	34	43	54	69	87	109	137	174	218
Double with capacitors	2x18=36	3	7	10	21	35	56	70	87	112	140	175	221	281	351
	2x36=72	1	3	5	10	17	28	35	43	56	70	87	110	140	175
	2x58=116	1	2	3	6	10	17	21	27	34	43	54	68	87	109
In [A] - 2P and 4P circuit-breakers		1	2	3	6	10	16	20	25	32	40	50	63	80	100

Fluorescent lamps. 230 VAC three-phase – Delta connection

Type of lamp	Tube diss. pwr. [W]	Number of lamps per phase													
Single without capacitors	18	2	5	8	16	28	45	56	70	90	113	141	178	226	283
	36	1	2	4	8	14	22	28	35	45	56	70	89	113	141
	58	0	1	2	5	8	14	17	21	28	35	43	55	70	87
Single with capacitors	18	4	8	12	24	40	64	81	101	127	162	203	255	324	406
	36	2	4	6	12	20	32	40	50	64	81	101	127	162	203
	58	1	2	3	7	12	20	25	31	40	50	63	79	100	126
Double with capacitors	2x18=36	2	4	6	12	20	32	40	50	64	81	101	127	162	203
	2x36=72	1	2	3	6	10	16	20	25	32	40	50	63	81	101
	2x58=116	0	1	1	3	6	10	12	15	20	25	31	39	50	63
In [A] - 3P circuit-break.		1	2	3	6	10	16	20	25	32	40	50	63	80	100

Transformer protection

Insertion current

When the LV/LV transformers are powered up, very strong currents occur, which must be considered when selecting the protective device. The peak value of the first current wave often reaches a value between 10 and 15 times the transformer's effective rated current.

For power ratings below 50 kVA, it may reach between 20 and 25 times the rated current. This transient current decreases very rapidly with a time constant T varying from several ms to 10, 20 ms.

Main protection on the primary side

The tables below are the result of a set of tests on co-ordination between circuit-breakers and BT/BT transformers. The transformers used in the tests are normalized. The table, referring to a primary supply voltage of 230 or 400 V and to single-phase and three-phase transformers, indicate which circuit-breaker should be used according to the transformer power rating.

The transformers considered have the primary winding outside the secondary winding.

The circuit-breakers suggested allow:

- transformer protection in the event of maximum short-circuit;
- prevention of unwanted tripping when the primary winding is powered up using
 1. modular circuit-breakers with a high magnetic threshold, curve D or K
 2. circuit-breakers with magnetic only releaser;
- guaranteed circuit-breaker electrical life.

Protection on the secondary side

Due to the transformer's high insertion current, the circuit-breaker on the primary winding may not guarantee thermal protection for the transformer and its feeder line on the primary side.

This is typical of modular circuit-breakers which must have a higher rated current than the transformers. In such cases, in the event of a single-phase short-circuit at the transformer's primary terminals (minimum I_{cc} at end of line), check that the circuit-breaker's magnetic releaser is tripped. In the normal application in distribution panels, this condition is always satisfied provided that the length of the feeder lines is reduced.

The transformer can be provided with thermal protection by installing a circuit-breaker with a rated current less than or equal to that of the transformer secondary winding immediately downstream of the LV/LV transformer.

In lighting systems protection against overloads is not necessary if the number of light points is clearly defined (no overloads).

Moreover, the Standard in force for these systems recommends the omission of protection against overloads in circuits in which unwanted tripping may prove hazardous, e.g.: circuits which supply fire-fighting equipment.

Single-phase transformer (primary voltage 230 V)-1P and 1P+N MCBs

Pn [kVA]	In [A]	ucc (%)	Circuit-breaker on primary side (1) and (2)
0.1	0.4	13	S 2* D1 o K1
0.16	0.7	10.5	S 2* D2 o K2
0.25	1.1	9.5	S 2* D3 o K3
0.4	1.7	7.5	S 2* D4 o K4
0.63	2.7	7	S 2* D6 o K6
1	4.2	5.2	S 2* D10 o K10
1.6	6.8	4	S 2* D16 o K16
2	8.4	2.9	S 2* D16 o K16
2.5	10.5	3	S 2* D20 o K20
4	16.9	2.1	S 2* D40 o K40
5	21.1	4.5	S 2* D50 o K50
6.3	27	4.5	S 2* D63 o K63
8	34	5	S 290 D80
10	42	5.5	S 290 D100
12.5	53	5.5	S 290 D100

Single-phase transformer (primary voltage 400 V)-2P MCBs

Pn [kVA]	In [A]	ucc (%)	Circuit-breaker on primary side (1) and (2)
1	2.44	8	S 2* D6 o K6
1.6	3.9	8	S 2* D10 o K10
2.5	6.1	3	S 2* D16 o K16
4	9.8	2.1	S 2* D20 o K20
5	12.2	4.5	S 2* D32 o K32
6.3	15.4	4.5	S 2* D40 o K40
8	19.5	5	S 2* D50 o K50
10	24	5	S 2* D63 o K63
12.5	30	5	S 2* D63 o K63
16	39	5	S 290 D80
20	49	5	S 290 D100

Three-phase transformer (primary voltage 400 V)-3P, 3P+N and 4P MCBs

Pn [kVA]	In [A]	ucc (%)	Circuit-breaker on primary side (1) and (2)
5	7	4.5	S 2* D20 o K20
6.3	8.8	4.5	S 2* D20 o K20
8	11.6	4.5	S 2* D32 o K32
10	14	5.5	S 2* D32 o K32
12.5	17.6	5.5	S 2* D40 o K40
16	23	5.5	S 2* D63 o K63
20	28	5.5	S 2* D63 o K63
25	35	5.5	S 290 D80
31.5	44	5	S 290 D80
40	56	5	S 290 D80
50	70	4.5	S 290 D100

S 2*.. = S 200, S 200 M, S 200 P

(1) With modular or magnetic only circuit-breakers, without thermal adjustment, thermal protection is required for the transformer's secondary winding.

(2) Breaking capacity selected according to estimated Icc at the point where the breaker is installed.

Double tampoprinting of S 200 P

The breaking capacity

For the modular circuit-breakers realized according to IEC/EN 60898 standard, the breaking capacity is expressed by the I_{cn} quantity, indicated in Ampere, contained within a rectangle on the front side of the device. The max value of rated short-circuit capacity (I_{cn}) considered by this standard is 25000 A.

Always according to IEC/EN 60898 standard, the ratio between the service short-circuit capacity (I_{cs}) and the rated short-circuit capacity (I_{cn}) – K factor – shall have to be conforming to the enclosed table.

I_{cn}	K
< 6000 A	1
> 6000 A	
< 10000 A	0.75 ^(*)
>10000 A	0.5 ^(**)

(*) I_{cs} minimum value: 6000 A
(**) I_{cs} minimum value: 7500 A

Limiting class

The Manufacturer of the circuit-breaker has the right to declare the energy limiting class of the device. According to IEC/EN 60898 standard, the Manufacturer classifies the circuit-breaker with a limiting class which ranges from 1 to 3 according to the I^2t values let through by the circuit-breaker for rated current up to 16 A and rated currents exceeding 16 A up to 32 A included, according to the table below.

Short-circuit rated capacity (A)	Limited energy classes					
	1		2		3	
	I^2t max (A ² s)		I^2t max (A ² s)		I^2t max (A ² s)	
	B-C Type		B Type	C Type	B Type	C Type
3000	No		31000	37000	15000	18000
4500	limits		60000	75000	25000	30000
6000	are		100000	120000	35000	42000
10000	specified		240000	290000	70000	84000

Short-circuit rated capacity (A)	Limited energy classes					
	1		2		3	
	I^2t max (A ² s)		I^2t max (A ² s)		I^2t max (A ² s)	
	B-C Type		B Type	C Type	B Type	C Type
3000	No		40000	50000	18000	22000
4500	limits		80000	100000	32000	39000
6000	are		130000	160000	45000	55000
10000	specified		310000	370000	90000	110000

For instance, a circuit-breaker with rated current 16 A, B characteristic, with short-circuit rated capacity equal to 6 kA belongs to class 3 if it lets through max 35000 A²s of specific energy. The limiting class value (1, 2 or 3) is indicated on the front side of the device, within a square, in addition to the breaking capacity.

As regards the miniature circuit-breakers S200P series, two different breaking capacities are indicated on the front side of the device, contained in a rectangle.

The breaking capacity indicated above the operating toggle is the one of the device, according to IEC/EN 60898 standard, the breaking capacity indicated under the lever is regarding the limiting class which, according to the standard, can be expressed only for values up to 10000 A.

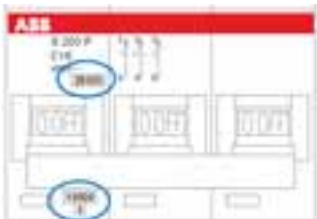

2CSC400227F0201

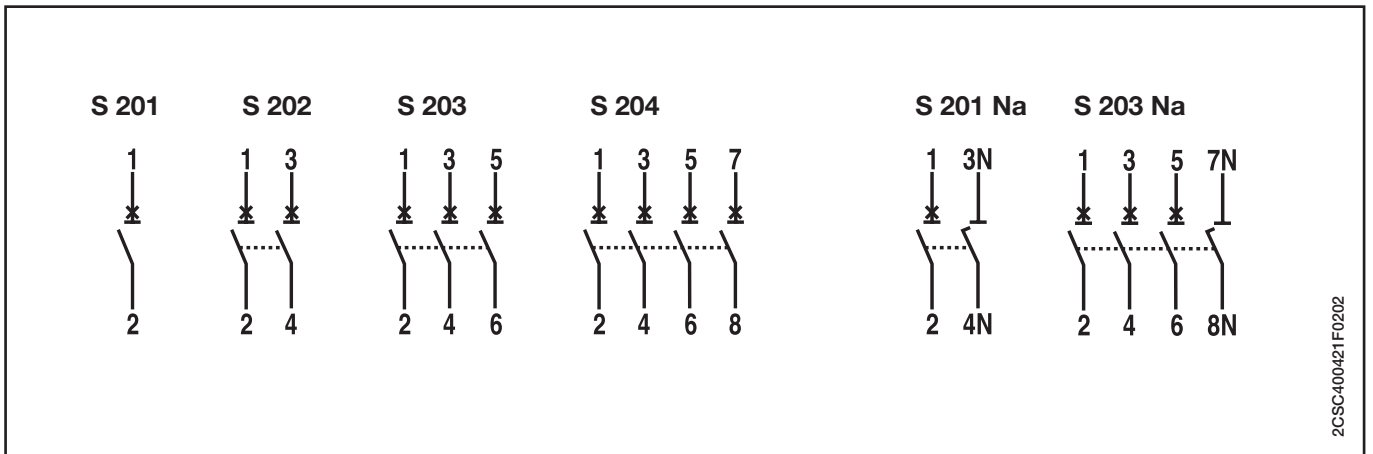

2CSC400421 F0202



RCCBs

2CSC400422F0202

Functions and classification criteria for RCDs

A residual current operated circuit-breaker is an amperometric protection device which is tripped when the system leaks a significant current to earth.

This device continuously calculates the vector sum of the single-phase or three-phase system line currents and while the sum is equal to zero allows electricity to be supplied. This supply is rapidly interrupted if the sum exceeds a value preset according to the sensitivity of the device.

Residual current operated circuit-breakers can be classed according to four parameters:

- type of construction
- detectable wave form
- tripping sensitivity
- tripping time.

Depending on the type of construction, RCDs may be classed as:

- RCBOs (magnetothermic with overcurrent protection)
- RCCBs (without overcurrent protection releaser incorporated)
- RCD blocks.



RCD-blocks

2CSC400563F0001

RCBOs combine, in a single device, the residual current function and the overcurrent protection function typical of MCBs. RCBOs are tripped by both current leakage to earth and overloads and short-circuits and they are self-protecting up to a maximum short-circuit current value indicated on the label.

RCCBs are only sensitive to current leakage to earth. They must be used in series with an MCB or fuse which protects them from the potentially damaging thermal and dynamic stresses of any overcurrents.

These devices are used in systems already equipped with MCBs which preferably limit the specific energy passing through, also acting as the main disconnecting switches upstream of any derived MCBs (e.g.: domestic consumer unit).



RCBOs

2CSC400193F0201

RCD blocks are residual current devices suitable for assembly with a standard MCB. IEC/EN 61009 app. G only allows assembly of RCBOs once on site, that is to say outside the factory, using adaptable RCD blocks and the appropriate MCBs. Any subsequent attempts to separate them must leave permanent visible damage. The residual current operated circuit-breaker obtained in this way maintains both the electrical characteristics of the MCB and those of the RCD block.

According to the wave form of the earth leakage currents they are sensitive to, the RCDs may be classed as:

- AC type (for alternating current only)
- A type (for alternating and/or pulsating current with DC components)
- B type (for alternating and/or pulsating current with DC components and continuous fault current).

AC type RCDs are suitable for all systems where users have sinusoidal earth current.

They are not sensitive to impulsive leakage currents up to a peak of 250 A (8/20 wave form) such as those which may occur due to overlapping voltage impulses on the mains (e.g.: insertion of fluorescent bulbs, X-ray equipment, data processing systems and SCR controls).

A type RCDs are not sensitive to impulsive currents up to a peak of 250 A (8/20 wave form).

They are particularly suitable for protecting systems in which the user equipment has electronic devices for rectifying the current or phase cutting adjustment of a physical quantity (speed temperature, light intensity, etc.) supplied directly by the mains without the insertion of transformers and insulated in class I (class II is, by definition, free of faults to earth). These devices may generate a pulsating fault current with DC components which the A type RCD can recognise.

B type RCDs are recommended for use with drives and inverters for supplying motors for pumps, lifts, textile machines, machine tools, etc., since they recognise a continuous fault current with a low level ripple.

Type AC, A and B RCDs comply with IEC/EN 61008/61009, moreover type B is covered by IEC 62423 Ed. 1 and by IEC/EN 60755 for residual current operated protective devices.

According to tripping sensitivity ($I_{\Delta n}$ value), RCDs may be divided into the following categories:

- low-sensitivity ($I_{\Delta n} > 0.03$ A), not suitable for protection against direct contacts; co-ordinated with the earth system according to the formula $I_{\Delta n} < 50/R$, to provide protection against indirect contacts;
- high-sensitivity ($I_{\Delta n}$: 0.01...0.03 A), or “physiologically sensitivity” for protection against indirect contacts, with simultaneous additional protection against direct contacts.
- against fire (up to 500 mA) according to IEC/EN 60364

Residual current sensitivity and environment

Household and special environments



$I_{\Delta n}$
≤ 30 mA

High-sensitivity or physiologically sensitive RCDs

IEC/EN 60364 makes the use of these devices mandatory in all bathrooms, showers and private and public swimming pools and environments in which plugs and sockets may be installed without insulating or low safety voltage transformers.

Laboratories, service industry and small industry



$I_{\Delta n}$
from 30 mA
to 500 mA

Low-sensitivity RCDs

Large service industry and industrial complex



$I_{\Delta n}$
from 500 mA
to 1000 mA

According to their tripping time, RCDs can be classed as:

- instantaneous (or rapid or general)
- type S selective (or - incorrectly - delayed).

Selective RCDs (RCBOs - RCCBs or RCD-blocks) have a delayed tripping action and are installed upstream of other rapid residual current operated circuit-breakers to guarantee selectivity and limit the power out only to the portion of the system affected by a fault.

The tripping time is not adjustable. It is set according to a predetermined time – current characteristic with an intrinsic delay for small currents, tending to disappear as the current grows.

IEC/EN 61008 and 61009 establish the tripping times relative to the type of RCD and the $I_{\Delta n}$.

Type AC	I_n [A]	I_{Δ} [A]	Tripping times (s)xcurrents			
			$1 \times I_{\Delta}$	$2 \times I_{\Delta}$	$5 \times I_{\Delta}$	500A
Generic	Any	Any	0.3	0.15	0.04	0.04
S (selective)	Any	>0.030	0.13-0.5	0.06-0.2	0.05-0.15	0.04-0.15

The indicated maximum tripping times are also valid for A type RCDs, but increasing the current values of factor 1.4 for RCDs with $I_{\Delta n} > 0.01$ A and of factor 2 for RCDs with $I_{\Delta n} \leq 0.01$ A.

The range of ABB RCDs also includes AP-R (anti-disturbance) devices which trip according to the limit times allowed by the Standards for instantaneous RCDs. This function is due to the slight tripping delay (approx. 10 ms) relative to the standard instantaneous ones.

The graph shows the comparison of the qualitative tripping curves for:

- a 30 mA instantaneous RCD
- a 30 mA AP-R instantaneous RCD
- a 100 mA selective RCD (type S)

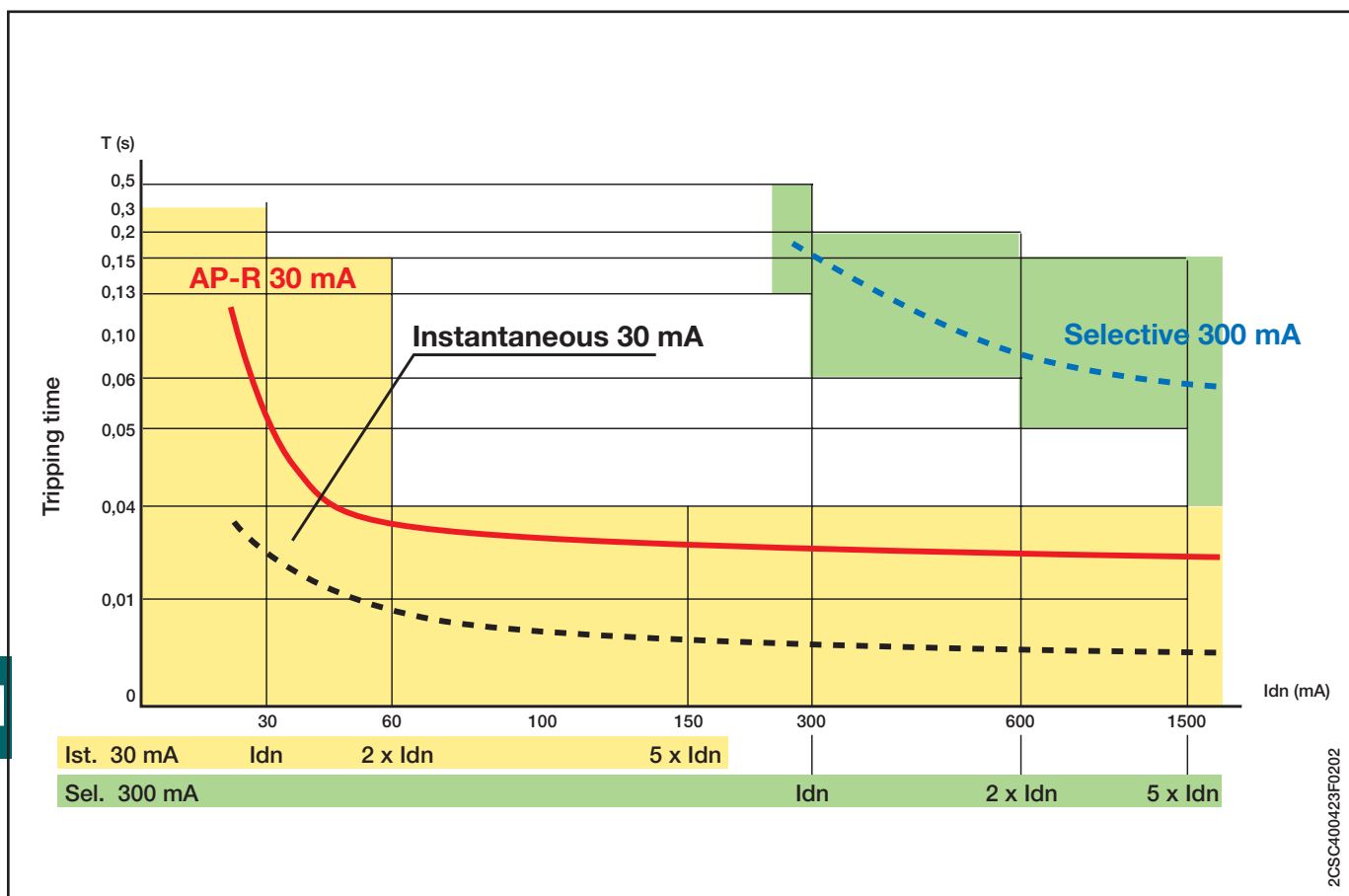

Note: this is a qualitative chart; it is referred only to industrial frequencies of 50-60 Hz.

For many years the manufacturers of electrical appliances and other electrical equipment have been using electronic components to improve the performance of their products, increase comfort and save energy.

Loads such as washing machines with variations in spin speed, variable-speed tools, thermostats and dimmers operate at currents with varying wave shapes (pulsating currents with DC components, inverted currents, levelled currents).

There are three different types of current (fig. A).

Figure A

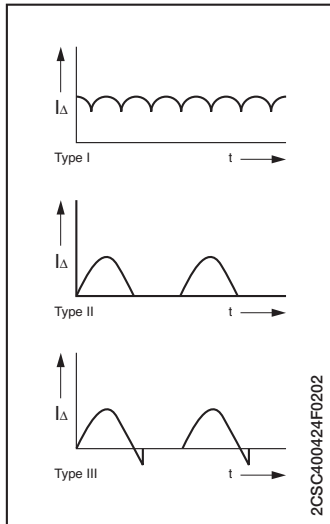

Type I Inverted current with DC components, with value continuously greater than zero, caused by:

- three-phase current
- median point and three-phase current
- jumper connection
- unidirectional rectification with inductive and capacitive levelling
- Villard type voltage doubling.

Type II Pulsating current with DC components sometimes with zero value, caused by ohmic load with:

- unidirectional rectification without levelling
- single-phase jumper connection with or without levelling
- regulation of the symmetrical and asymmetrical phase operating angle (dimers, RPM meters).

Type III Pulsating current with DC components passing through zero caused by inductive loads with:

- unidirectional rectification without levelling
- single-phase jumper connection with or without levelling
- symmetrical and asymmetrical regulation of the phase operating angle (dimers, RPM meters).

If there is a fault current to earth after an insulation fault on live parts supplied with rectified current, the contact voltages are the same size as in alternating current.

Figure B

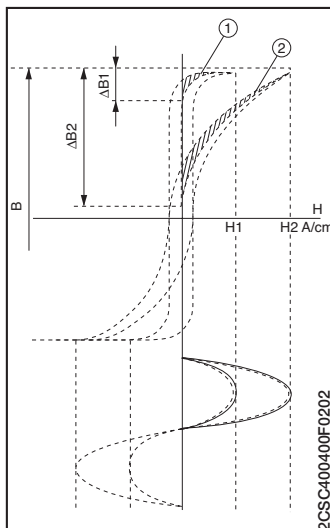

Standard RCDs, which are designed to operate with alternating current at 50-60 Hz, are insensitive to fault currents with DC components.

Non-tripping of a RCD when there are fault currents with DC components may have two consequences:

- it is dangerous for people and equipment (electrocution or fire)
- it causes desensitization of RCD due to excessive polarization of the transformer core that is no longer able to send the necessary power supply to the releaser (figure B - hysteresis cycle 1).

To avoid this problem, type A RCDs must be used. Thanks to the specific technology of the residual current transformer toroidal cores, the supply level is increased to a value sufficient to trigger the releaser or tripping mechanism (figure B - hysteresis cycle 2).

The sensitivity of the tripping mechanism is further increased by its connection to an electrical circuit sensitive to the wave shape of the current.

In this way the tripping of the RCD is assured for any unidirectional pulsating wave shape even in case of overlapping of a DC component up to 6 mA.

Coordination tables between Short Circuit Protection Devices (SCPD) and F 200 RCCBs

If you are using an RCCB you must verify that the Short Circuit Protection Device (SCPD) protects it from the effects of high current that arise under short-circuit conditions. The IEC/EN 61008 provides some tests to verify the behaviour of RCCB in short-circuit conditions. The tables below provide the maximum withstanding short-circuit current expressed in eff. kA for which the RCCBs are protected thanks to the coordination with the SCPD installed upstream or downstream. The tests are performed with SCPD with a rated current (thermal protection) less than or equal to the rated current of the associated RCCB.

F 202

	Single-phases 230-240 V circuit					
	25 A	40 A	63 A	80 A	100 A	125 A
SN201L/S201L Na	4.5	4.5				
SN201/S201 Na	6	6				
SN201M/S201M Na	10	10				
S202L	10	10				
S202	20	20	20			
S202M	25	25	25			
S202P	40	25	25			
S292	25	25	25	25	25	25
S802N	36	36	36	36	36	36
S802S	50	50	50	50	50	50
Fuse 25 gG	100					
Fuse 40 gG	60	60				
Fuse 63 gG	20	20	20			
Fuse 100 gG	10	10	10	10	10	
Fuse 125 gG						10

F 202

	400-415 V circuits with isolated neutral (IT) under double faults					
	25 A	40 A	63 A	80 A	100 A	125 A
SN201N/SN201/SN201M	3	3				
S201L/S201L Na/S202L	4.5	4.5				
S201/S201 Na/S202	6	6	6			
S201M/S201M Na/S202M	10	10	10			
S201P/S201P Na/S202P	25	15	15			
S291/S292	10	10	10	10	10	10
S801N/S802N	20	20	20	20	20	20
S801S/S802S	25	25	25	25	25	25

F 204

	Three-phases circuits with neutral (y/Δ) 230-240 V/400-415 V*					
	25 A	40 A	63 A	80 A	100 A	125 A
SN201L/S201L/S201LNa*	4.5	4.5				
SN201/S201/S201Na*	6	6				
SN201M/S201M/S201MNa*	10	10				
S202L*	10	10				
S202*	20	20	20			
S202M*	25	25	25			
S202P*	40	25	25			
S292*	25	25	25	25	25	25
S802N*	36	36	36	36	36	36
S802S*	50	50	50	50	50	50
Fuse 25 gG	100					
Fuse 40 gG	60	60				
Fuse 63 gG	20	20	20			
Fuse 100 gG	10	10	10	10	10	
Fuse 125 gG						10

* The switches are considered between phase and neutral (230/240V)

F 204

	Three-phases circuits with neutral (y/Δ) 230-240 V/400-415 V					
	25 A	40 A	63 A	80 A	100 A	125 A
S203L/S204L	4.5	4.5				
S203/S204	6	6	6			
S203M/S204M	10	10	10			
S203P/S204P	25	15	15			
S293/S294	10	10	10	10	10	10
S803N/S804N	20	20	20	20	20	20
S803S/S804S	25	25	25	25	25	25
Fuse 25 gG	50					
Fuse 40 gG	30	30				
Fuse 63 gG	20	20	20			
Fuse 100 gG	10	10	10	10	10	
Fuse 125 gG						10

F 204

	Three-phases circuits with neutral (y/Δ) 133-138V/230-240V					
	25 A	40 A	63 A	80 A	100 A	125 A
SN201L	10	10				
SN201	15	15				
S2010M	20	20				
S203L/S204L	10	10				
S203/S204	20	20	20			
S203M/S204M	25	25	25			
S203P/S204P	40	25	25			
S293/S294	25	25	25	25	25	25
S803N-S804N	36	36	36	36	36	36
S803S-S804S	50	50	50	50	50	50
Fuse 25 gG	100					
Fuse 40 gG	60	60				
Fuse 63 gG	20	20	20			
Fuse 100 gG	10	10	10	10	10	
Fuse 125 gG						10

Selectivity

RCDs raise similar issue to those surrounding the installation of MCBs, and in particular the need to reduce to a minimum the parts of the system out of order in the event of a fault.

For RCBOs the problem of selectivity in the case of short-circuit currents may be handled with the same specific criteria as for MCBs.

However, for correct residual current protection, the more important aspects are linked to tripping times. Protection against contact voltages is only effective if the maximum times indicated on the safety curve are not exceeded.

If an electrical system has user devices with earth leakage currents which exceed the normal values (e.g.: presence of capacitor input filters inserted between the device phase and earth cables) or if the system consists of many user devices, it is good practice to install various RCDs, on the main branches, with an upstream main residual current or non-residual current device instead of a single main RCD.

Horizontal selectivity

The non-residual current main circuit-breaker provides “horizontal selectivity”, preventing an earth fault at any point on the circuit or small leakage from causing unwanted main circuit-breaker tripping, which would put the entire system out of order.

However, in this way, section k of the circuit between the main circuit-breaker and the RCDs remains without “active” protection. Using a main RCD to protect it would lead to problems with “vertical selectivity”, which require tripping of the various devices to be co-ordinated, so that service continuity and system safety are not compromised. In this case, selectivity may be amperometric (partial) or chronometric (total).

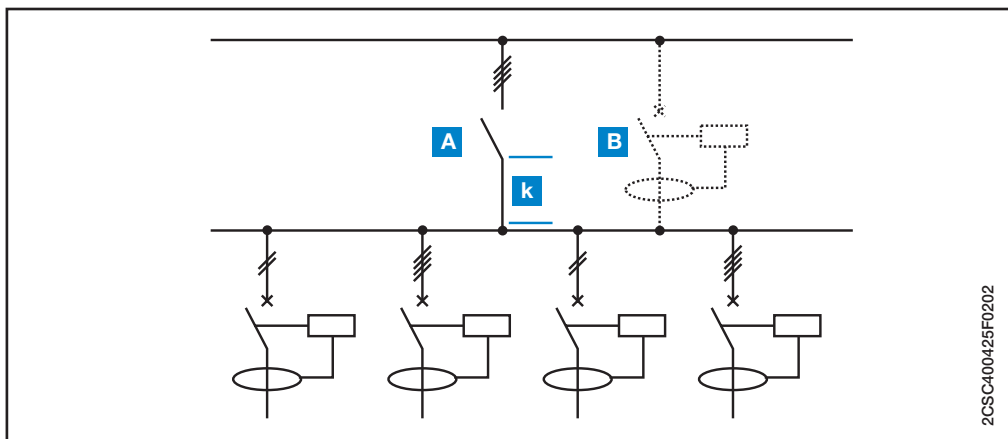

Vertical selectivity

Vertical selectivity may also be established for residual current tripping, bearing in mind that in working back from system peripheral branches to the main electrical panels the risk of unskilled persons coming into contact with dangerous parts is significantly reduced.

Amperometric (partial) selectivity

Selectivity may be created by placing low-sensitivity RCDs upstream and higher-sensitivity RCDs downstream.

An essential condition which must be satisfied in order to achieve selective co-ordination is that the $I_{\Delta 1}$ value of the breaker upstream (main breaker) is more than double the $I_{\Delta 2}$ value of the breaker downstream. The operative rule to obtain an amperometric (partial) selectivity is $I_{\Delta n}$ of the upstream breaker = 3 x $I_{\Delta n}$ of the downstream breaker (e. g.: F 204, A type, 300 mA upstream; F 202, A type, 100 mA downstream).

In this case, selectivity is partial and only the downstream breaker trips for earth fault currents $I_{\Delta 2} < I_{\Delta m} < 0.5 \cdot I_{\Delta 1}$.

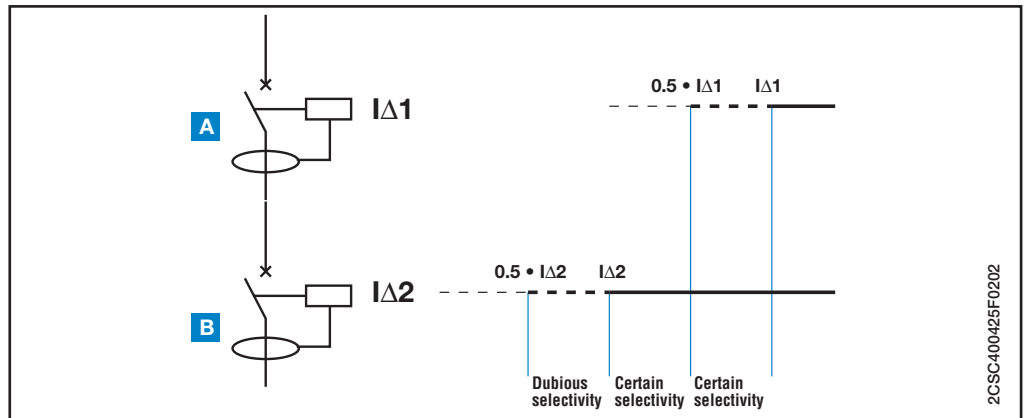

Chronometric (total) selectivity

To achieve total selectivity, delayed or selective RCDs must be installed.

The tripping times of the two devices connected in series must be co-ordinated so that the total interruption time t_2 of the downstream breaker is less than the upstream breaker's no-response limit time t_1 , for any current value. In this way, the downstream breaker completes its opening before the upstream one.

To completely guarantee total selectivity, the $I\Delta$ value of the upstream device must also be more than double that of the downstream device in accordance with IEC 64-8/563.3, comments. The operative rule to obtain an amperometric (partial) selectivity is $I\Delta_n$ of the upstream breaker = 3 x $I\Delta_n$ of the downstream breaker (e. g.: F 204, S type, 300 mA upstream; F 202, A type, 100 mA downstream).

For safety reasons, the delayed tripping times of the upstream breaker must always be below the safety curve.

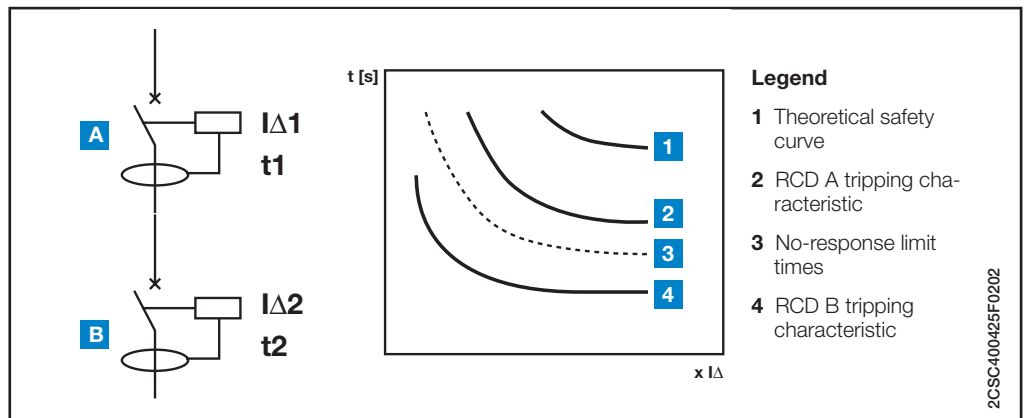

Table of RCD selectivity

Upstream $I\Delta_n$ [mA]		10	30	100	300	300	500	500	1000	1000
Downstream $I\Delta_n$ [mA]		inst	inst	inst	inst	S	inst	S	inst	S
10	inst		■	■	■	■	■	■	■	■
30	inst			■	■	■	■	■	■	■
100	inst				■	■	■	■	■	■
300	inst					■	■		■	■
300	S								■	■
500	inst									
500	S									
1000	inst									
1000	S									

inst=instantaneous S=selective ■=amperometric (partial) selectivity ■=chronometric (total) selectivity

Power loss and internal resistance of RCDs and RCBOs

RCCBs F200 series

Rated current I _n [A]	Power loss W [W]	
	2P	4P
16	1.5	-
25	1.0	1.3
40	2.4	3.2
63	3.2	4.4
80	8.8	33,3
100	15.2	44,4
125	-	28

RCD-Blocks DDA200 series

Rated current I _b [A]	Power loss W _{ib} * [W]	
	2P	3P,4P
25	2.0	3.0
40	3.2	4.8
63	5.0	7.6

* The power loss W_{ib} shown in the table refers to I_b. For use with circuit-breakers with lower rated current I_n the power loss W must be determined using the formula: $W = (I / I_b) \cdot W_{ib}$

RCD-Blocks DDA for S290 series

Rated current I _b [A]	Rated residual current I _{Δn} [A]	Power loss W [W]	
		2P	4P
100	0.03	6	6
100	0.03 - 1	5	5

RCD-Blocks DDA800

Rated current I _b [A]	Power loss W _{ib} * [W]	
	2P	4P
63	9	13.5
100	7	10.5

* The power loss W_{ib} shown in the table refers to I_b. For use with circuit-breakers with lower rated current I_n the power loss W must be determined using the formula: $W = (I / I_b) \cdot W_{ib}$

RCBOs DS 200, DS 200 M series

Rated current I _n [A]	Power loss W [W]			
	Characteristic 2P		Characteristic K 3P/4P	
6	4.1	6.2	3.9	5.9
10	2.9	4.4	2.9	4.2
13	5.2	7.7	3.1	4.5
16	4.5	6.6	4.9	7.2
20	6.4	9.3	6.8	9.9
25	8.5	12.4	7.9	11.5
32	10.9	15.7	10.7	15.4
40	15	21.6	14.4	20.7
50	11.4	18.4	10.7	17.4
63	17.4	28.2	18.2	29.4

RCBOs DS201, DS202C series

Rated current I _n [A]	DS201		DS202C	
	Power loss [W]	Internal resistance [mΩ]	Power loss [W]	Internal resistance [mΩ]
1	1,0	1011		
2	1,6	411		
4	2,5	155		
6	4,4	123,4	8,1	224,8
8	1,5	23,1		
10	2,3	23,1	4,1	40,6
13	2,2	13,3	3,5	21
16	3,4	13,3	5,4	21
20	4,4	11,1	6,6	16,6
25	3,9	6,2	5,5	8,8
32	5,9	5,8	8,2	8
40	8,6	5,4		

Derating of load capability of RCBOs DS 200 series, DS201 and DS202C

For DS 200 see tables for S 200 MCBs in technical details MCBs and dedicated tables for DS201 and DS202C, within the range of temperatures from -25 °C to +55 °C.

Performance in altitude of RCDs

ABB RCDs are able to operate at altitude higher than foreseen by the relevant standard IEC/ EN 61008 and IEC/ EN 61009 taking into account the corrective factor below detailed:

Altitude	Rated Current	Rated Voltage	Breaking capacity
3.000 m	0,96 x I _n	0,877 x U _n	It is necessary to select product with higher breaking capacity (e.g. if 6 kA is required, select a 10 kA product)
4.000 m	0,94 x I _n	0,775 x U _n	
5.000 m	0,92 x I _n	0,676 x U _n	
6.000 m	0,90 x I _n	0,588 x U _n	

For altitude higher than 3.000 m the isolating characteristic is no longer available.

Emergency stop using DDA 200 AE series RCD blocks

The AE series RCD block combines the protection supplied by the RCBOs with a positive safety emergency stop function for remote tripping.

In the AE version, the DDA 200 AE series RCD blocks are available.

Operating principle (patented)

Two additional primary circuits powered with the same voltage and equipped with the same resistance have been added to the transformer; under normal conditions the same current would flow through, but since they are wound by the same number of coils in opposite directions they cancel each other out and do not produce any flow.

One of these two windings acts as the remote control circuit: the emergency stop is obtained by interrupting the current flow in this circuit.

The positive safety is therefore obvious: an accidental breakage in the circuit is equivalent to operating an emergency control button.

Advantages

Compared with the devices which are normally used in emergency circuits, DDA 200 AE blocks have the following advantages:

- positive safety
- no undesirable tripping if there is a temporary reduction or interruption of the mains voltage
- efficient immediate operating even after long off-service periods of the installation.

Use

Application of the DDA 200 AE blocks complies with the requirements of IEC/EN 60364-8. They are therefore suitable, for example, for escalators, lifts, hoists, electrically operated gates, machine tools, car washes and conveyor belts.

No more than one DDA 200 AE can be controlled using the same control circuit. Each DDA 200 AE requires a dedicated control circuit.

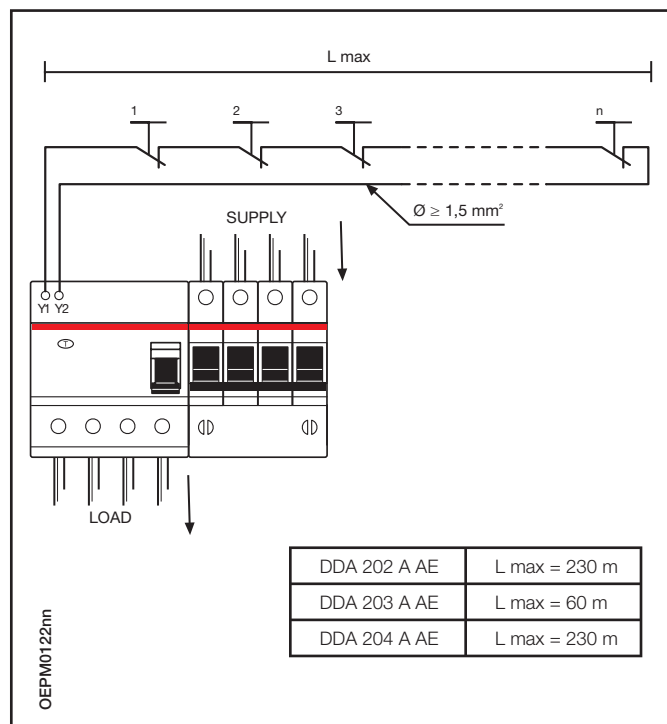
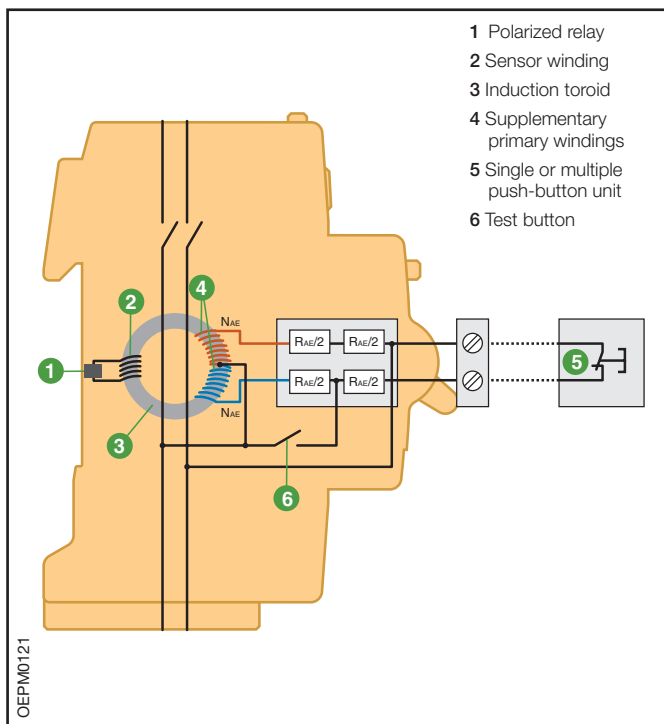

Unwanted tripping

In the event of disturbance in the mains, the RCDs normally present in the system are tripped, breaking the circuit even in the absence of a true earth fault.

Disturbances of this kind are most often caused by:

- operation overvoltages caused by inserting or removing loads (opening or closing protection of control devices, starting and stopping motors, switching fluorescent lighting systems on and off, etc.)
- overvoltages of atmospheric origin, caused by direct or indirect discharges on the electrical line.

Under these circumstances, breaker tripping is unwanted, since it does not satisfy the need to avoid the risks due to direct and indirect contacts. On the contrary, the sudden and unjustified interruption of the power supply may result in very serious problems.

AP-R RCDs

The ABB range of AP-R anti-disturbance residual current circuit-breakers and blocks was designed to overcome the problem of unwanted tripping due to overvoltages of atmospheric or operation origin.

The electronic circuit in these devices can distinguish between temporary leakage caused by disturbances on the mains and permanent leakage due to actual faults, only breaking the circuit in the latter case.

AP-R residual current circuit-breakers and blocks have a slight delay into the tripping time, but this does not compromise the safety limits set by the Standards in force (release time at $2 I_{\Delta n} = 150$ ms).

Guaranteeing conventional residual current protection, their installation in the electrical circuit therefore allows any unwanted tripping to be avoided in domestic and industrial systems in which service continuity is essential.

This delay makes the AP-R residual current devices especially suited for installations involving motor starters/variable speed drives, fluorescent lamps or IT/electronic equipment.

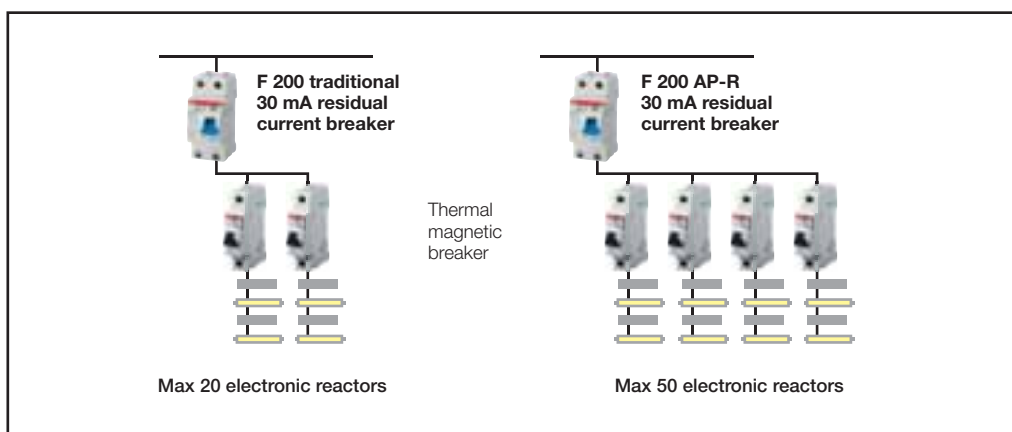

The use of multiple electronic reactors for the supply of fluorescent lamps instead generates permanent leakage currents and inrush currents that can provoke nuisance tripping of a standard residual current breaker.

IT system loads and other electronic equipment (e.g. dimmers, computers, inverters) with capacitive input filters connected between the phases and ground can also generate permanent earth leakage currents whose sum may provoke the nuisance tripping of a standard residual current breaker. For these situations, the AP-R breakers allow a greater number of devices to be connected to the installation.

Soft-starters for motors are loads which can generate high-frequency capacitive currents (provoked by the harmonics) toward ground or fed into the network. Also in this case, the use of AP-R residual breakers reduces the sensibility to nuisance tripping.

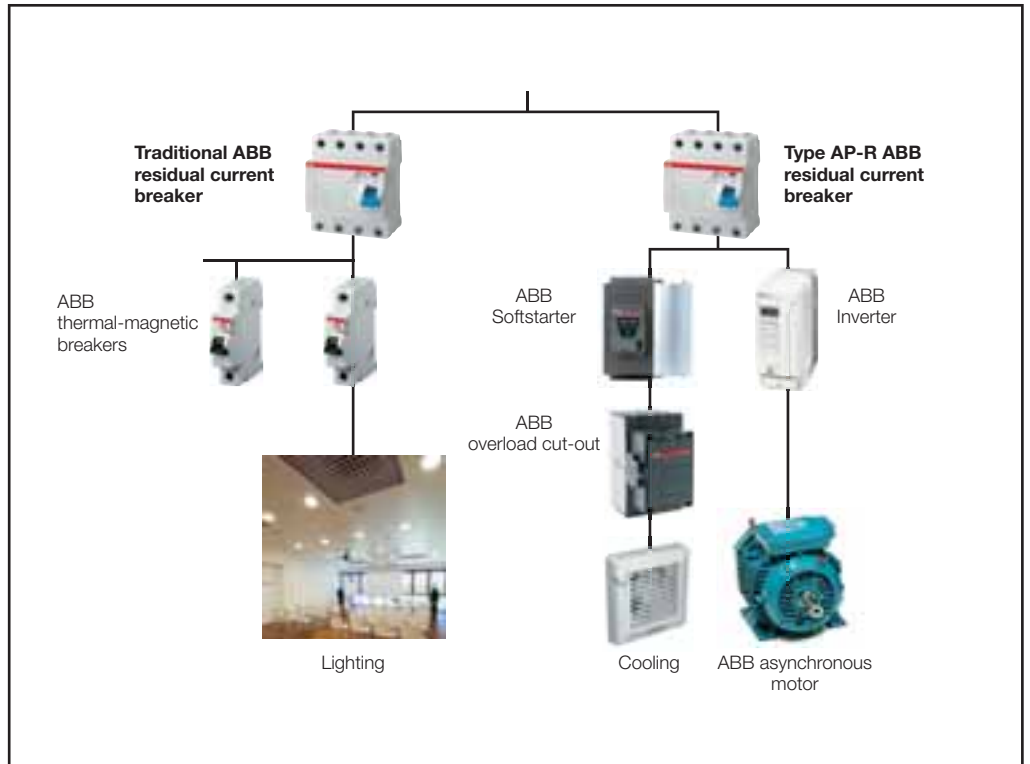

Compared with standard type breakers, AP-R residual current breakers are therefore characterised, for any given sensibility, by:

- Higher residual trip current
- Tripping time delay
- Better resistance to overvoltages, harmonics and impulse disturbances.

Regulations

The tests set out in the IEC 61008 and IEC 61009 standards verify the resistance of residual current breakers to unwanted tripping provoked by operation overvoltages, using a ring wave impulse shape of 0.5 μ s/100 kHz. All residual current circuit-breakers are required to pass this test with a peak current value of 200 A.

For what concerns atmospheric overvoltages, the IEC 61008 and 61009 standards prescribe the 8/20 μ s surge test with a 3000 A peak current, but limit the requirement to residual current devices classified as selective; no test is required for other types.

The ABB range of AP-R anti-nuisance tripping breakers and blocks pass the general 0.5 μ s/100 kHz ring wave test and also withstand the 8/20 μ s impulse test with the same peak current of 3000 A prescribed for selective devices.

	Instantaneous	AP-R	Selective
Resistance to unwanted tripping caused by network disturbances with wave shape (0.5 μs/100 kHz)	250	250	250
Resistance to nuisance tripping due to overvoltages (operational or atmospheric) peak (8/20 wave)	250	3000	5000

The F2C-ARH is an auto-reclosing device particularly suited for household and similar uses. Unlike the F2C-ARI auto-reclosing unit, it doesn't require a separate low voltage power supply, but can be supplied by the associated RCCBs (2 pole RCCBs up to 63 A – 30 mA) at the 230 V a.c. rated voltage.

Another feature that makes the product ideal for home applications is an internal control unit that checks there are no insulation faults in the system before allowing the RCCB to reclose.

This ensures that reclosing occurs only in case of unwanted tripping of the RCCB (i.e. overvoltages induced by electrical storms), thus assuring continuity of power supply also in these situations.

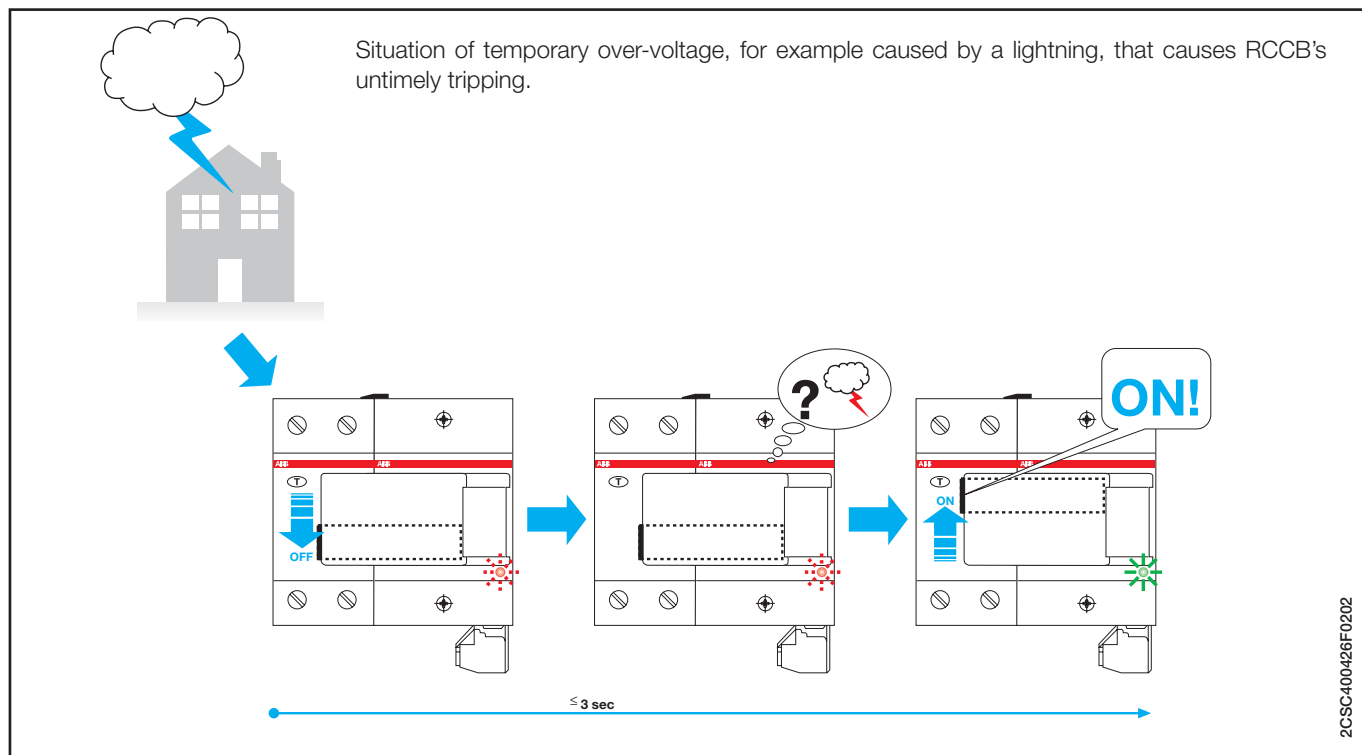

When the RCCB operates in presence of an effective insulation fault, the auto-reclosing device doesn't allow its reclosing and guarantees the system insulation.

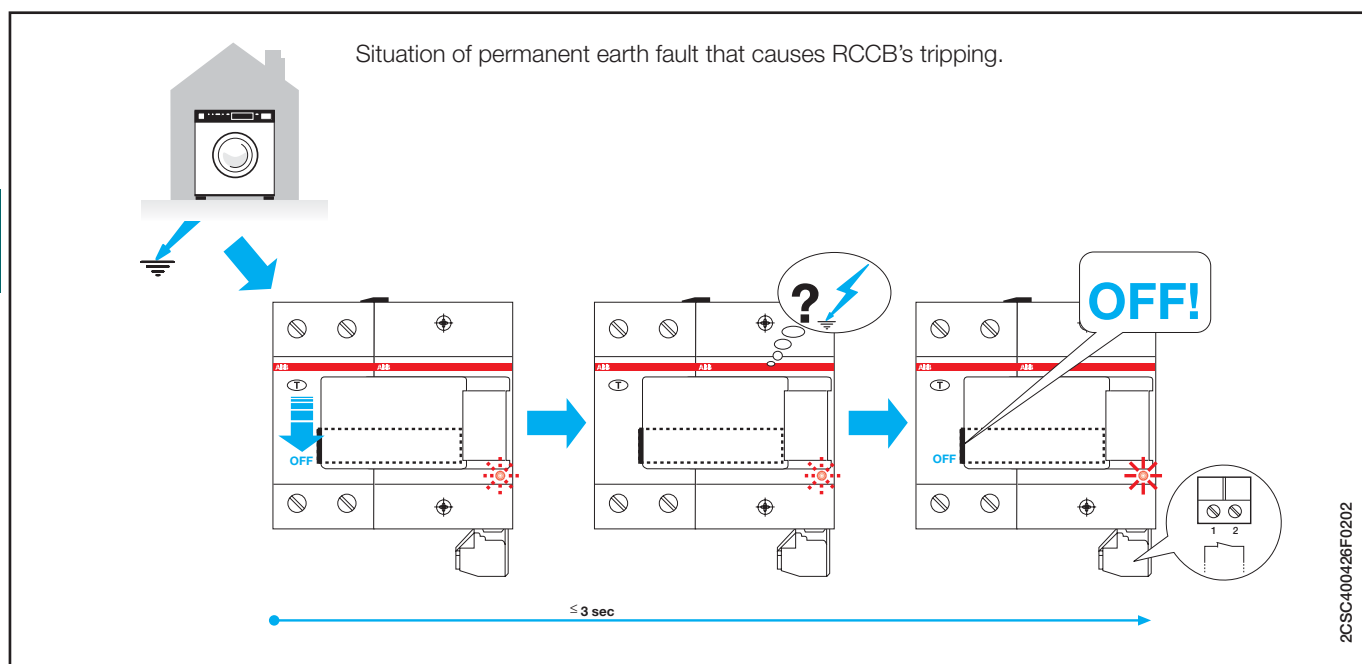

Type B RCDs

In industrial electrical applications it is more and more common to use devices where in the event of an earth fault current unidirectional direct currents or currents with a minimum residual ripple which flow through the PE conductor can emerge. These devices can be for example inverters, medical equipment (e.g. x-ray equipment and CAT), or UPS.

Type A RCDs sensitive to pulsating currents (in addition to sinusoidal currents detected by RCDs of type AC as well) cannot detect and break these earth fault direct currents or currents with a minimum level residual ripple. In case there are electrical appliances which generate this type of currents in the event of an earth fault the use of RCDs of type AC or type A would not be appropriate.

In order to meet these new demands, type B RCDs have been designed (which are able to detect the same earth fault currents detected by type AC and type A RCDs).



This type of RCD (type B) is not mentioned in the reference standards for RCDs (IEC 61008-1 and IEC 61009-1). An international standard has been introduced in 2007 and it specifies additional requirements for B type RCDs.

This new standard, IEC 62423, can only be referred to together with IEC 61008-1 (for RCCBs) and IEC 61009-1 (for RCD-blocks and RCBOs), this means that B type RCDs have to be compliant to all the prescriptions of IEC 61008/9.

As already said, type B RCDs are not only sensitive to alternating and pulsating earth fault currents with DC components at a frequency of 50/60 Hz (type A), but they are also sensitive to:

- alternating currents up to a frequency of 1000 Hz;
- alternating and/or pulsating currents with DC components overlapping with a direct current;
- earth fault currents generated by a rectifier with two or more phases;
- direct earth fault currents without residual ripple

...independently of the polarity or whether the earth fault current appears suddenly or increases gradually.

Type B RCDs must be marked with the following symbols highlighting the switches' capacity to detect every type of current:  .

Construction features

Type B RCDs consist of one section for the detection of alternating earth fault currents and unidirectional pulsating earth fault currents, which functions independently of the line voltage. For the detection of direct earth fault currents or currents with a minimum residual ripple, type B RCDs have a second electronic section, the functioning of which depends on the line voltage. The structure of the product is illustrated in the following diagram.

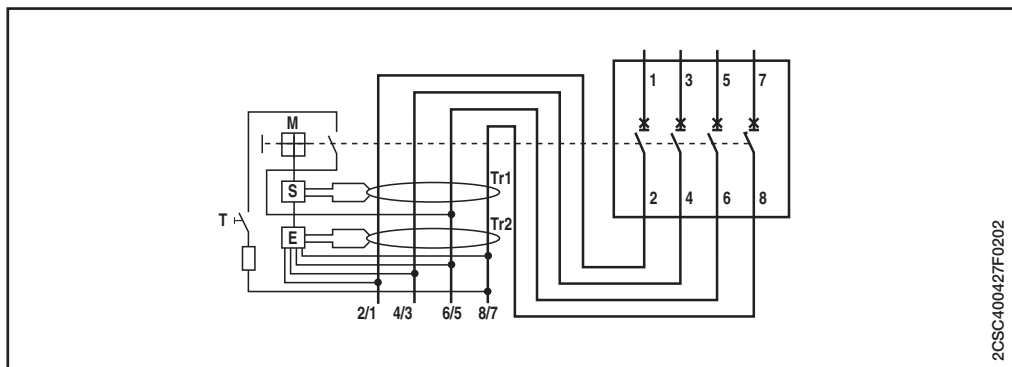

- S** Release
- M** Protection device mechanism
- E** Electronics for the intervention with direct unidirectional earth fault currents
- T** Test device
- Tr1** Residual current transformer for the detection of sinusoidal earth fault currents
- Tr2** Residual current transformer for the detection of direct unidirectional currents.

The residual current transformer Tr1 monitors the presence of pulsating and alternating earth fault currents in the electronic installation while residual current transformer Tr2 measures the direct unidirectional currents. In the event of a fault the second transformer transmits the opening command to the release S via the (printed) circuit board E. In type B RCCBs, the section whose functioning depends on the line voltage is supplied by all three-phase conductors and the neutral, so that the functioning as type B is guaranteed even if there is a voltage only in two of the 4 power conductors. In addition, the supply of the electronic section is sized in such a way that the device can safely intervene even if there is a voltage drop of 70%. In this way an intervention takes place when direct unidirectional earth fault currents emerge, even in the event of faults in the electric power supply grid, for example if there is no neutral conductor.

Direct or similar earth fault currents

An increasing amount of industrial equipment is supplied by circuits which in the event of a fault generate direct earth fault currents with a very low residual ripple, which can be even less than 10%. For example with direct current supplied motor drives for pumps, elevators, textile machines etc. it is becoming more common to use inverters with a three-phase rectifier bridge. In the event of an earth fault current the wave of the earth fault is as indicated in the figure below.

11

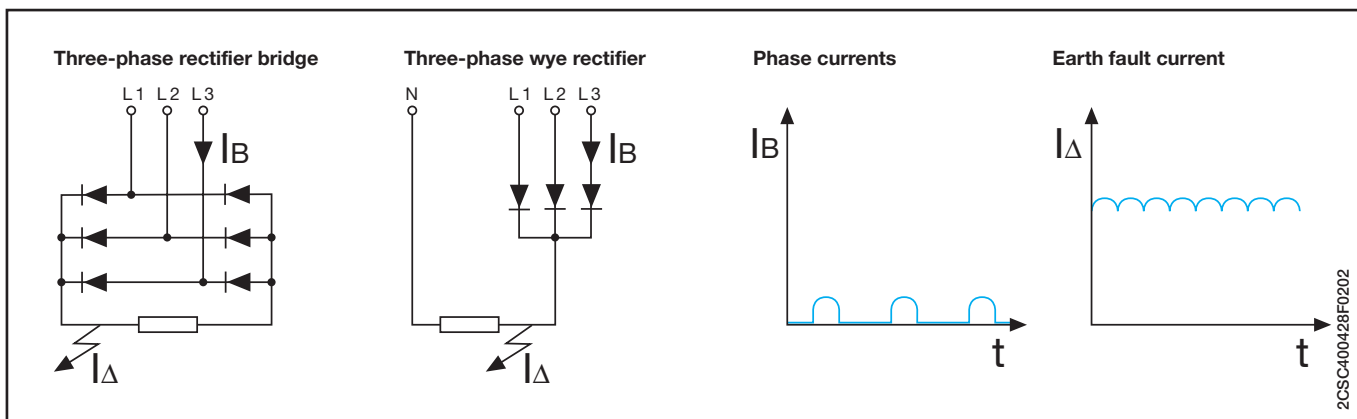

Variation of residual current tripping thresholds according to frequency

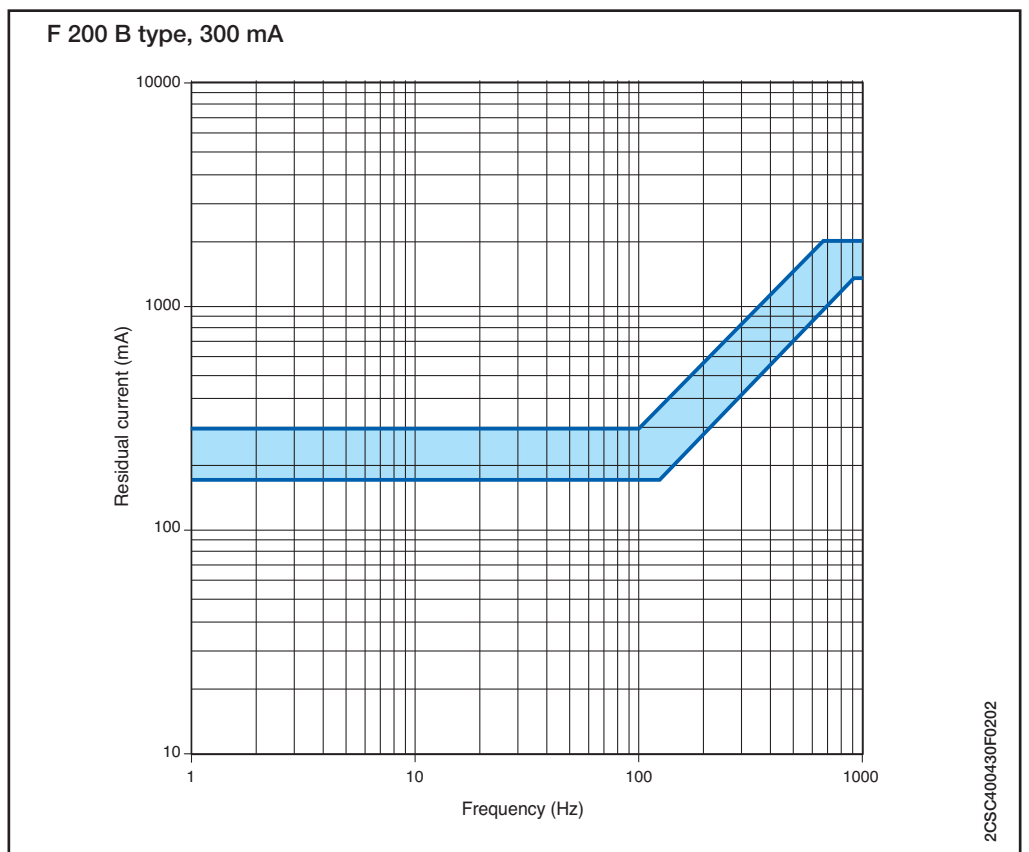
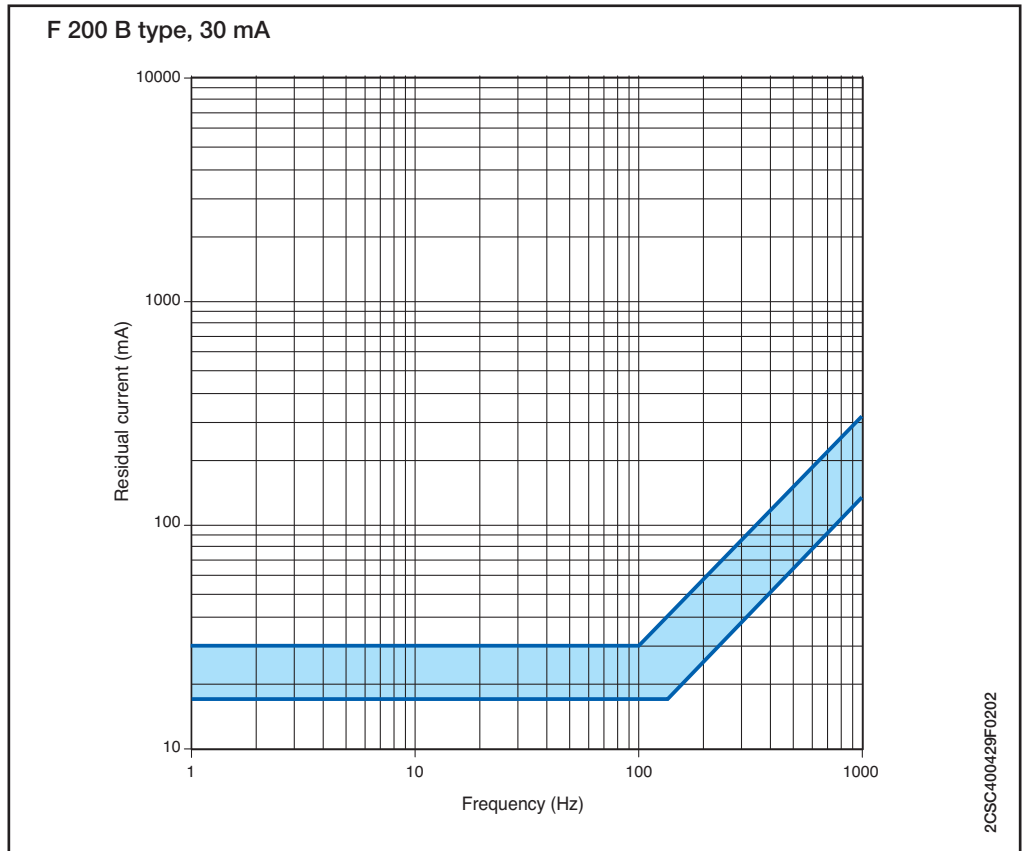

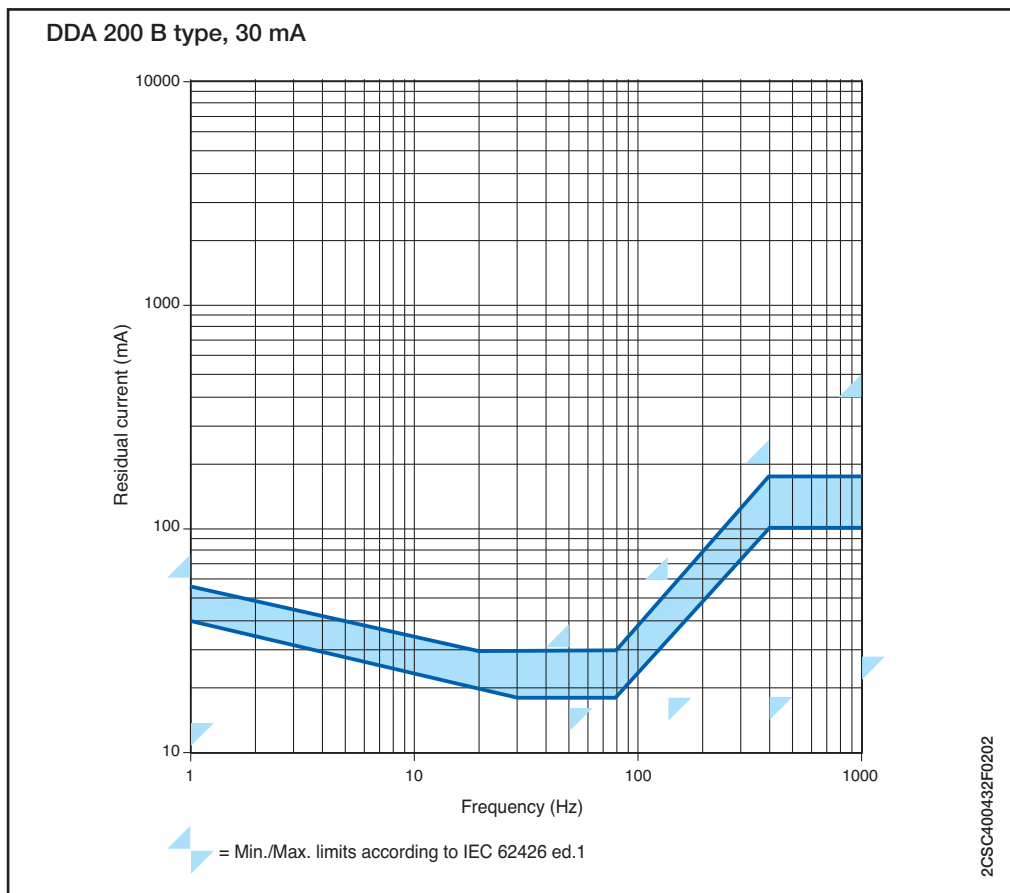
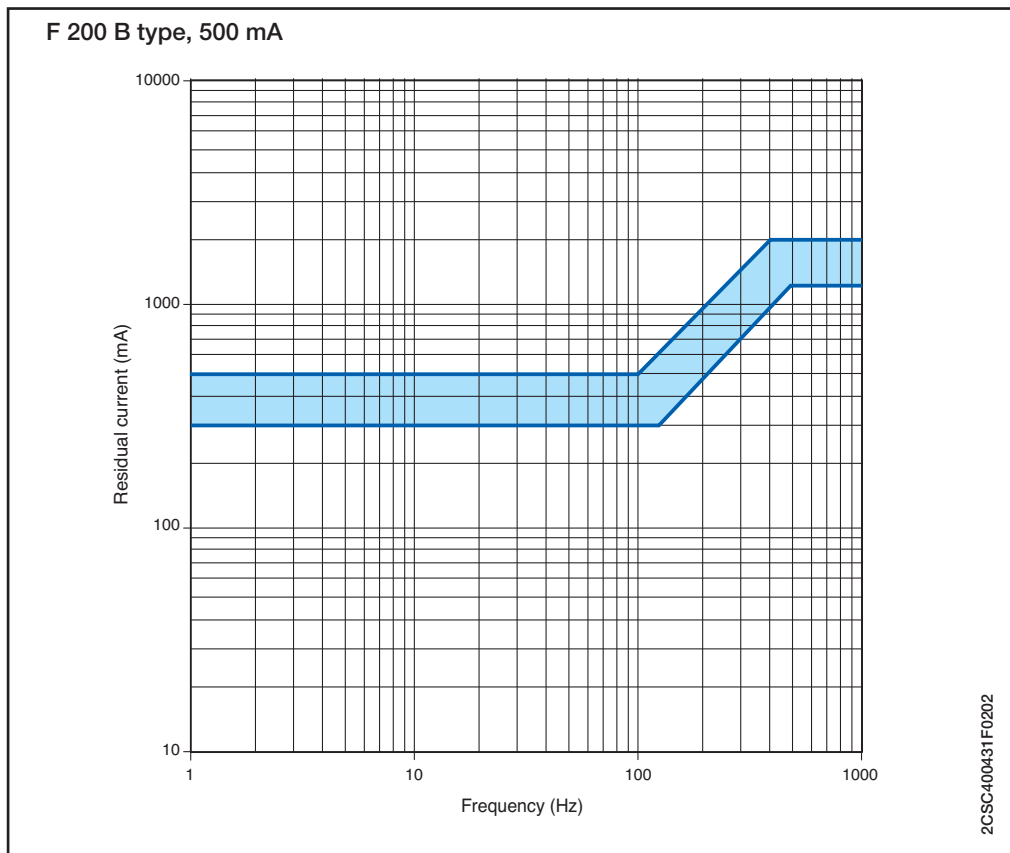

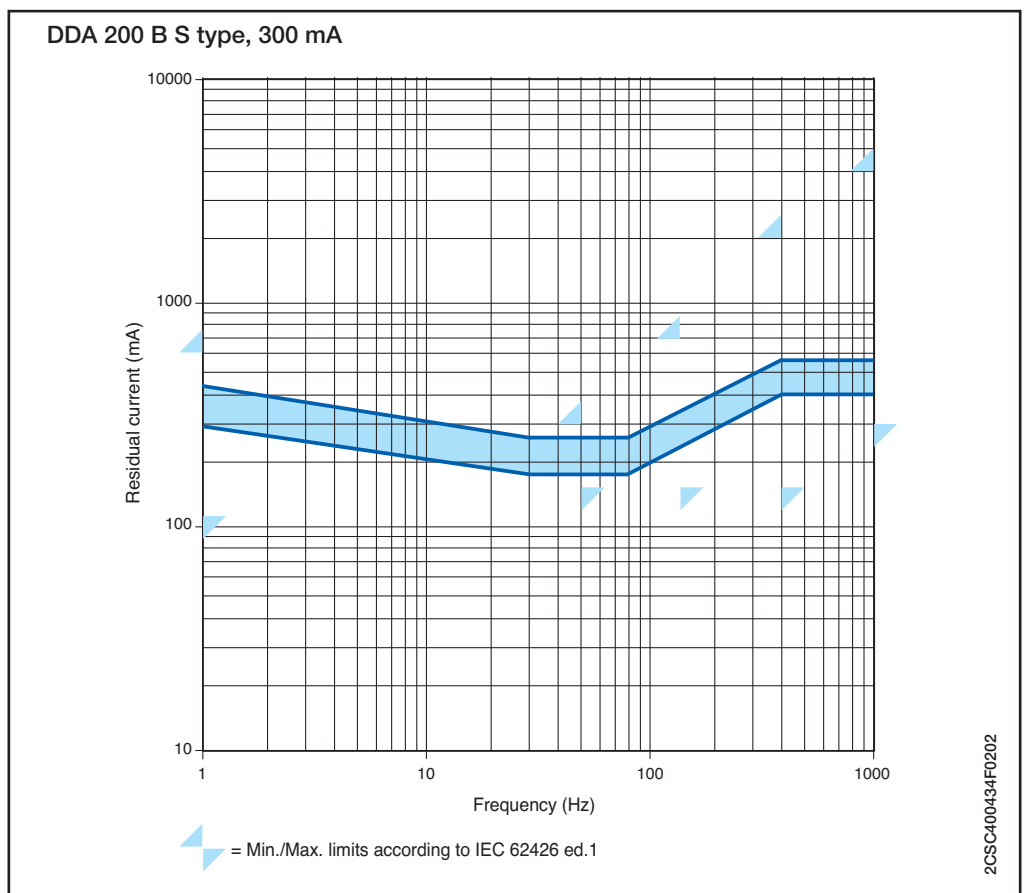
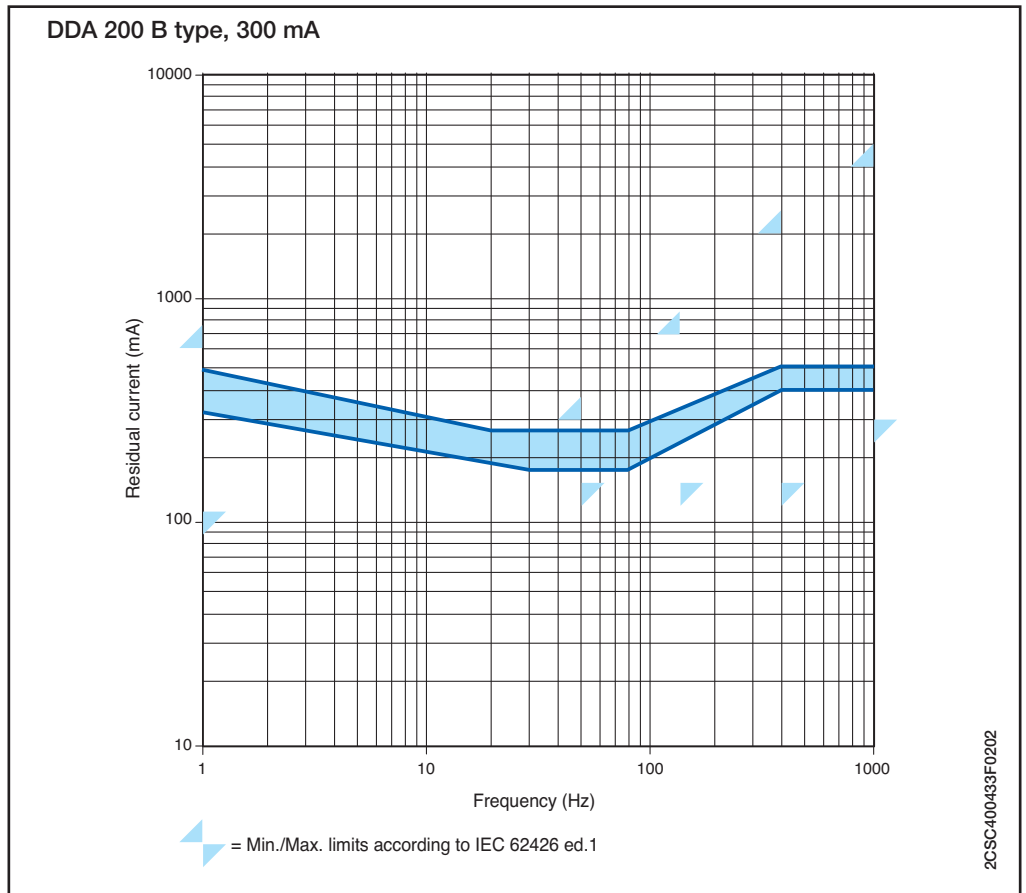

Use of a 4P RCCB in a 3-phase circuit without neutral

The test button circuit of these RCCBs 4P F 200 is wired inside the device between terminal 5/6 and 7/8/N as indicated below, and has been sized for an operating voltage between 110 and 254 V (110 and 277 V according to UL 1053).

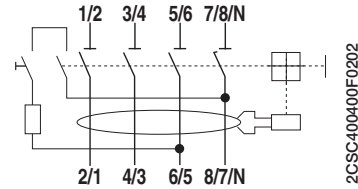

In case of installation in a 3 phase circuit without neutral, if the concatenate voltage is between 110 and 254 V (277 V according to UL 1053) for the correct working of the test button there are two possible solutions:

- 1) To connect the 3 phases to the terminals 3/4 5/6 7/8/N and the terminals 4/3 6/5 8/7/N (supply and load side respectively)
- 2) To connect the 3 phases normally (supply to terminals 1/2 3/4 5/6 and load to terminals 2/1 4/3 6/5) and to bridge terminal 1/2 and 7/8/N in order to bring to the terminal 7/8/N the potential of the first phase. In this way the test button is supplied with the phases' concatenate voltage.

If the circuit is supplied with a concatenate voltage higher than 254 V, as in the typical case of 3 phase net with concatenate voltage of 400 V - or 480 V according to UL 1053 - (and voltage between phase and neutral of 230 V or 277 V according to UL 1053), it is not possible to use these connections because the circuit of the test button will be supplied at 400 V and could be damaged by this voltage.

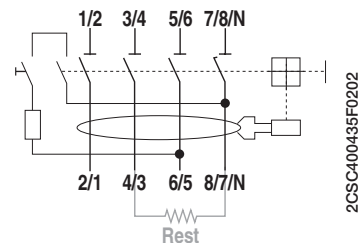

$I\Delta n$ [A]	R_{est} [Ω]
0.03	3300
0.1	1000
0.3	330
0.5	200

In order to allow the correct operation of the test button also in 3 phase nets at 400 V - 480 V according to UL 1053 - (concatenate voltage) it is necessary to connect normally the phases (supply to terminals 1/2 3/4 5/6 and load to terminals 2/1 4/3 6/5) and to jump terminal 4/3 and 8/7/N by mean of an electric resistance as indicated above.

In this way the test button circuit is fed at 400 V - 480 V according to UL 1053 - but for example in an RCCB with $I\Delta n=0.03$ A there will be the $R_{est}=3.3$ kOhm resistance in series to the test circuit resistance. R_{est} will cause a voltage drop that leaves in the test circuit a voltage less than 254 V - 277 V according to UL 1053. R_{est} resistance must have a power loss higher than 4 W.

In the normal operation of the RCCB (test circuit opened) the R_{est} resistance is not fed so it does not cause any power loss.

The solution RCCBs with neutral pole on left side

The test button circuit of these RCCBs is wired inside the device between terminal 3/4 and 5/6 as indicated below, and it has been sized for an operating voltage between 195 V and 440 V - 480 V. In case of a three phase system without neutral with concatenate voltage between phases of 230 V or 400 V - 277 V or 480 V - it is enough to connect the 3 phases normally (supply to terminals 1/2 3/4 5/6 and load to terminals 2/1 4/3 6/5) without any bridge.

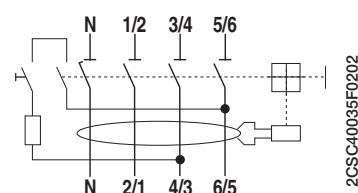

Operating voltage of test button

The operation of RCDs depends on the maximum and minimum operating voltage of the test button.

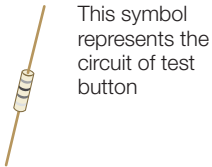

Maximum and minimum operating voltage of DS201 and DS202C test button

DS201
Ut = 110-254 V

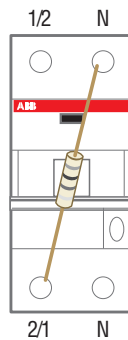

DS202C
Ut = 110-254 V

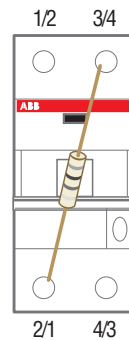

Between the two terminals there is a rated voltage of 110-254 V

2CSC400436F0202

Maximum and minimum operating voltage of DS 200 and DDA 200 test button

DDA 202 and DS 202
In = 25-40 A
Ut = 110-254 V

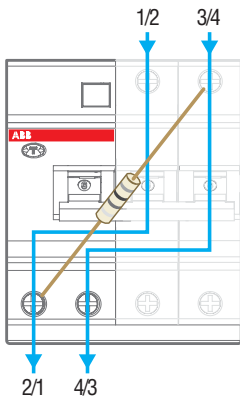

DDA 202 and DS 202
In = 63 A
Ut = 110-254 V

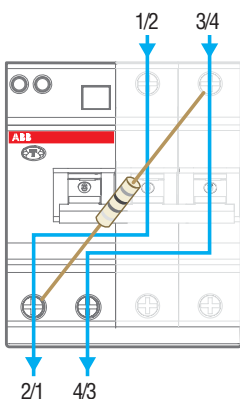

DDA 203 and DS 203
In = 25-40 A
Ut = 195-440 V

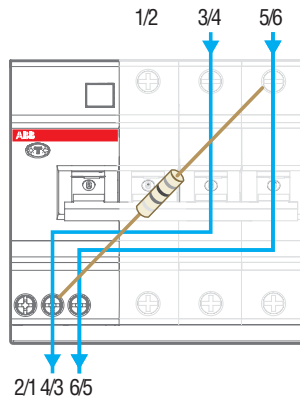

DDA 203 and DS 203
In = 63 A
Ut = 195-440 V

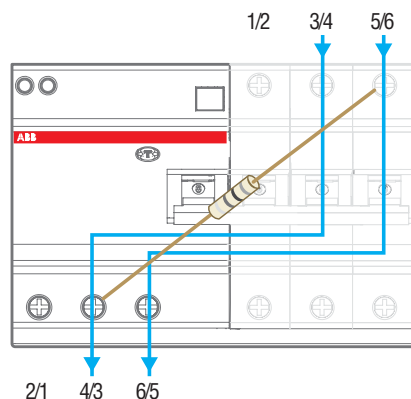

DDA 204 and DS 204
In = 25-40 A
Ut = 195-440 V

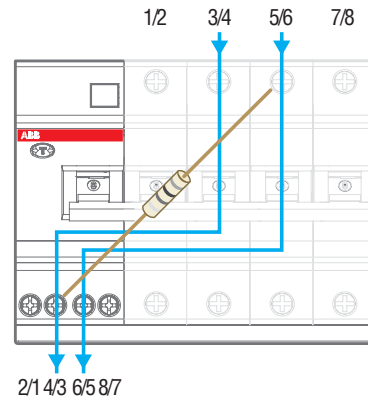

DDA 204 and DS 204
In = 63 A
Ut = 195-440 V

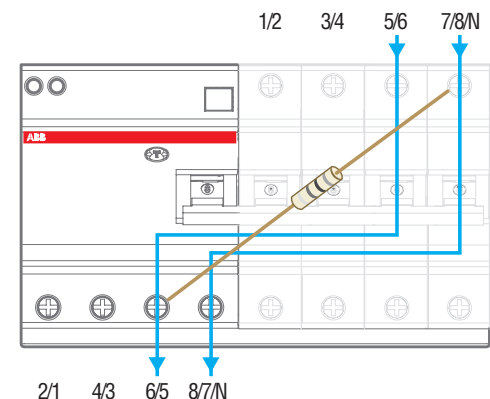

2CSC400436F0202

pro M compact® Operating voltage of test button

Maximum and minimum operating voltage of DDA 200, special version 110 V

DDA 203 110 V
In = 40 A
Ut = 110-254 V

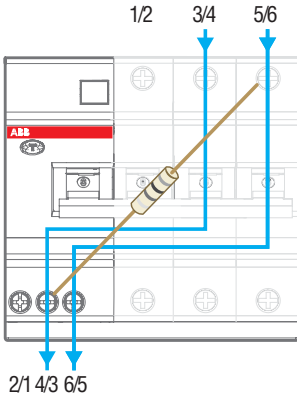

DDA 203 110 V
In = 63 A
Ut = 110-254 V

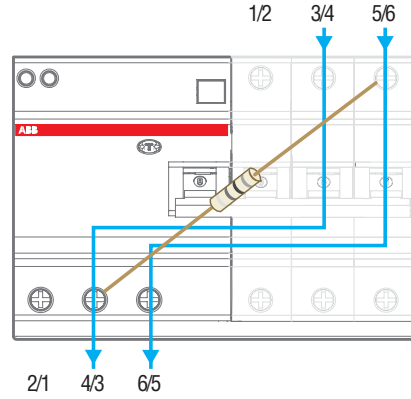

DDA 204 110 V
In = 63 A
Ut = 110-254 V

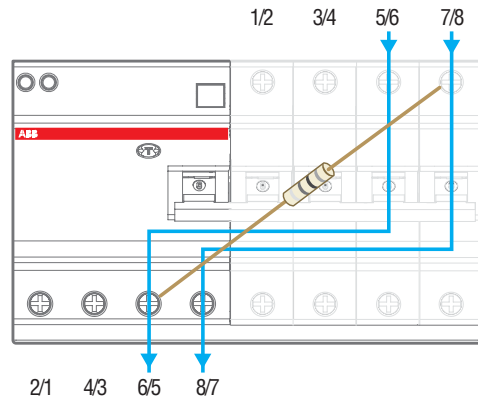

2CSC400437F0202

Maximum and minimum operating voltage of DDA 200, special version 400 V

DDA 202
In = 63 A
Ut = 400 V

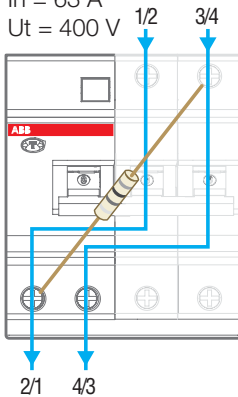

Maximum and minimum operating voltage of DDA 200 B type test button

DDA 202 B
In = 63 A
Ut = 110-254 V

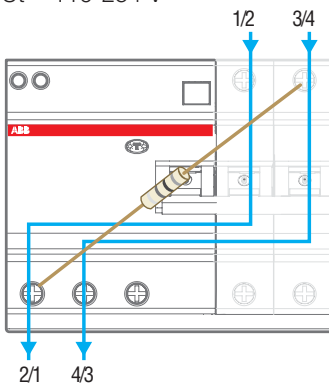

DDA 203 B
In = 63 A
Ut = 310-440 V

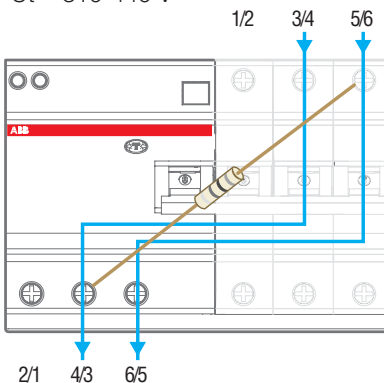

DDA 204 B
In = 63 A
Ut = 195-254 V

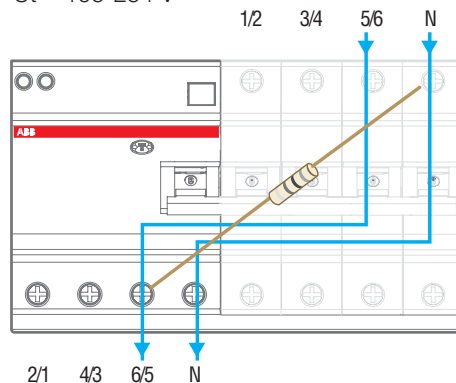

2CSC400438F0202

Maximum and minimum operating voltage of DDA 200 AE test button

DDA 202 AE
 $I_n = 63 \text{ A}$
 $U_t = 184\text{-}264 \text{ V}$

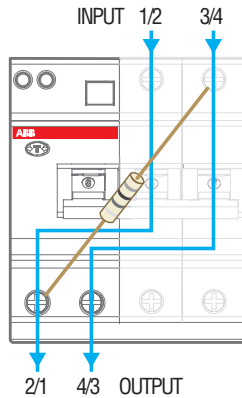

DDA 203 AE
 $I_n = 63 \text{ A}$
 $U_t = 310\text{-}440 \text{ V}$

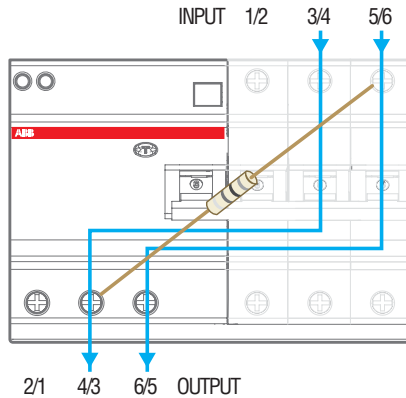

DDA 204 AE
 $I_n = 63 \text{ A}$
 $U_t = 184\text{-}264 \text{ V}$

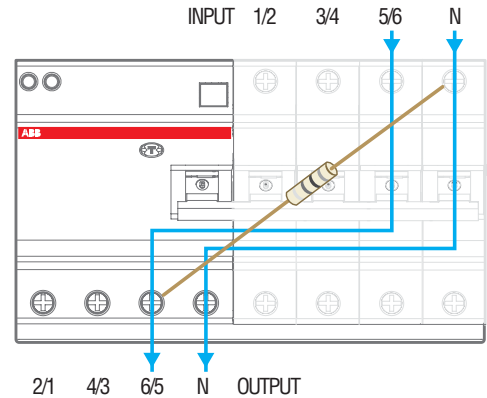

2CSC400439F0202

Maximum and minimum operating voltage of F 200 standard test button

F 202 standard
 $I_n \leq 100 \text{ A}$
 $U_t = 110\text{-}254 \text{ V}$

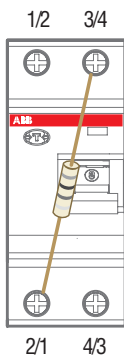

F 204 standard
 $I_n \leq 100 \text{ A}$
 $U_t = 110\text{-}254 \text{ V}$

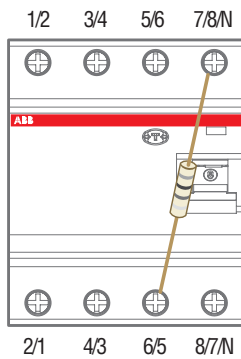

F 204 standard
 $I_n = 125 \text{ A}$
 $U_t = 185\text{-}440 \text{ V}$

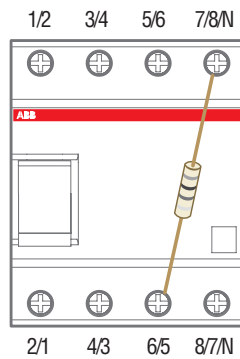

2CSC400436F0202

Maximum and minimum operating voltage of F 200 B and F 200 B (N on the left) type test button

F 204 B
 $I_n \leq 63 \text{ A}$
 $U_t = 185\text{-}440 \text{ V}$

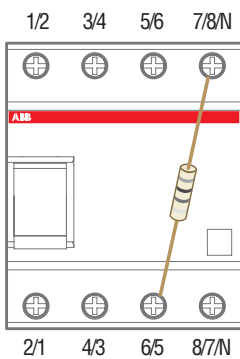

F 204 B
 $I_n = 125 \text{ A}$
 $U_t = 185\text{-}440 \text{ V}$

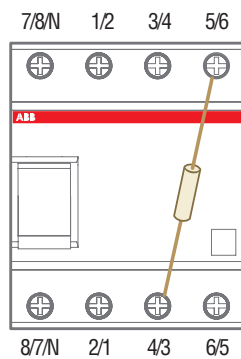

F 202 PV B
 $I_n \leq 63 \text{ A}$
 $U_t = 230 \text{ V}$

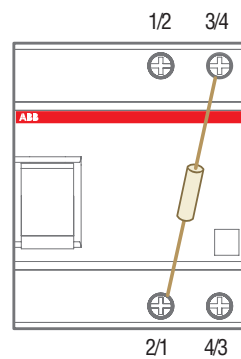

2CSC400436F0202

Maximum and minimum operating voltage of F 200 (N on the left) test button

F 204 neutral on left
 $I_n = \leq 100 \text{ A}$
 $U_t = 195-440 \text{ V}$

	R	S	T
7/8/N	1/2	3/4	5/6

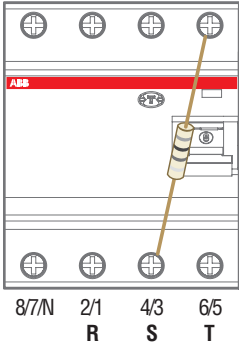

For use in 3-phases circuit without neutral at 400 V it is possible to connect the three phases R, S and T like in the figure.

2CSC400436F0202

Maximum and minimum operating voltage of DDA 60-70-90 test button

DDA 62, DDA 72, DDA 92 with S 290
 $I_n = 100 \text{ A}$
 $U_t = 100-240 \text{ V}$

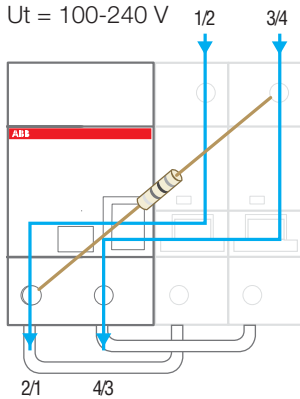

DDA 64, DDA 74, DDA 94 with S 290
 $I_n = 100 \text{ A}$
 $U_t = 175-415 \text{ V}$

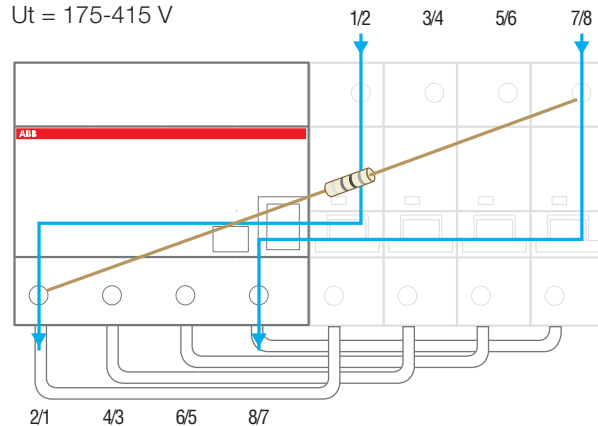

2CSC400440F0202

pro M compact® Operating voltage of test button

Maximum and minimum operating voltage of DDA 800 and DS800 test button

DDA 802
DS802
IN ≤ 125 A
Ut = 195-690 V

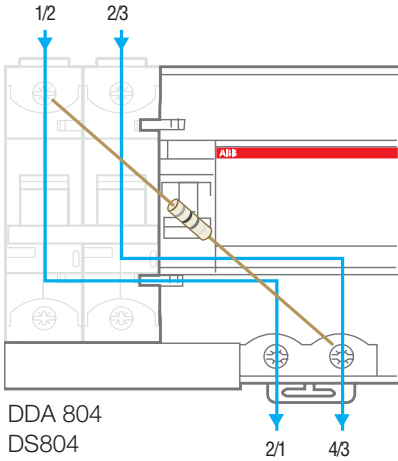

DDA 803
DS803
IN ≤ 125 A
Ut = 195-690 V

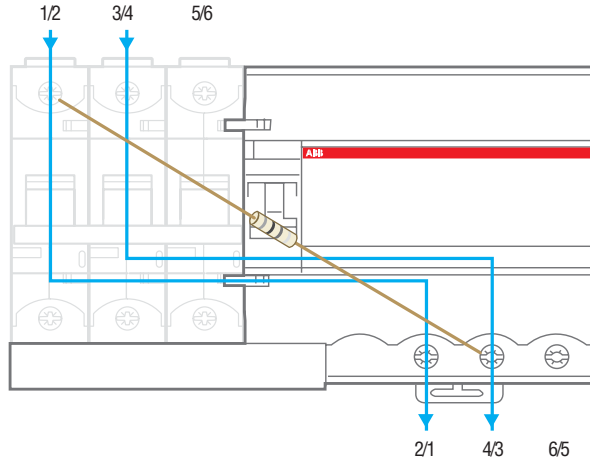

DDA 804
DS804
IN ≤ 125 A
Ut = 195-690 V

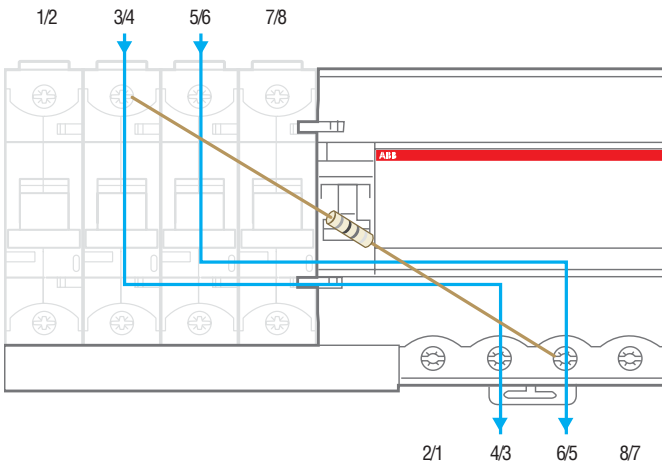

2CSC400440F0202

RCDs

F 202

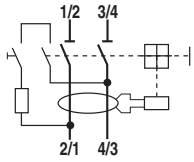

F 204

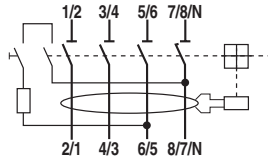

F 204 Left neutral

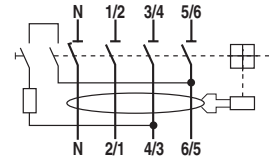

F 202 PV B

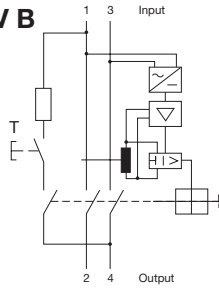

F 204 B type

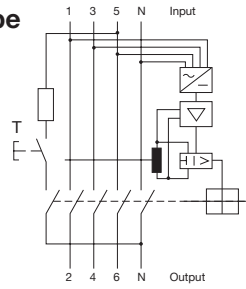

F 204 B type left neutral

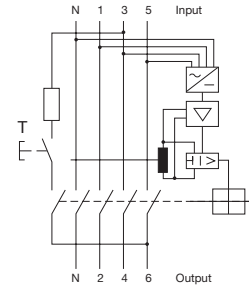

2CSC400441F0202

RCD-blocks

DDA 202

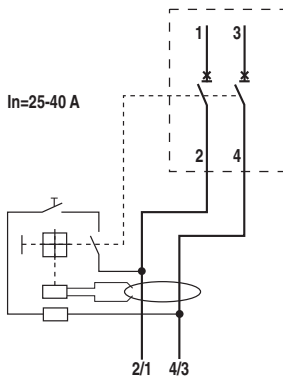

DDA 203

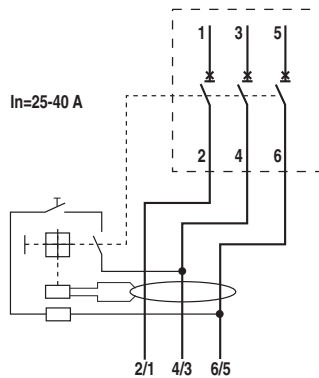

DDA 204

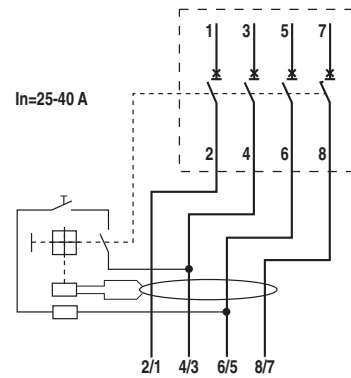

DDA 202

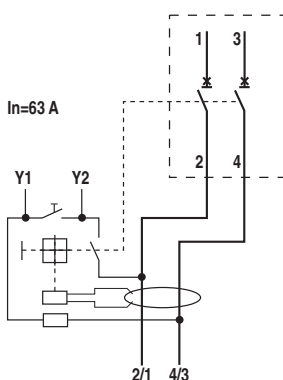

DDA 203

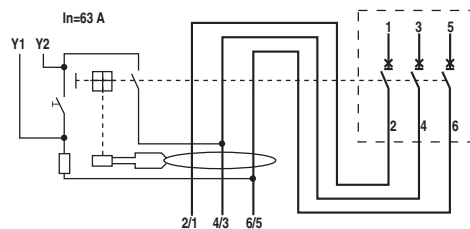

DDA 204

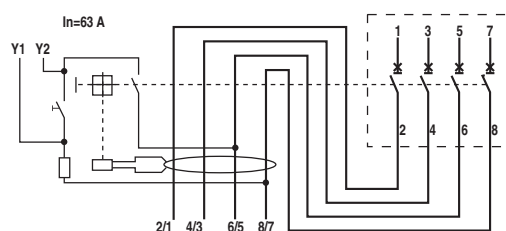

2CSC400441F0202

RCD-blocks

DDA 202 AE

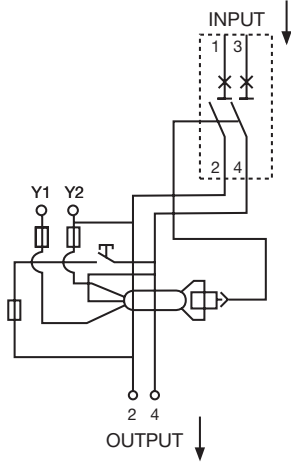

DDA 203 AE

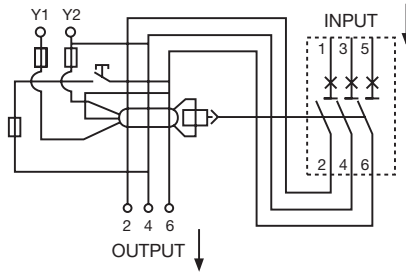

DDA 204 AE

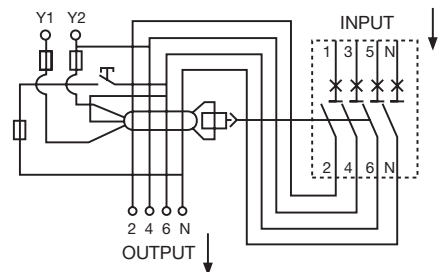

DDA 202 B type

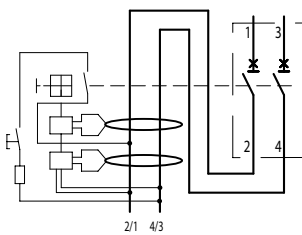

DDA 203 B type

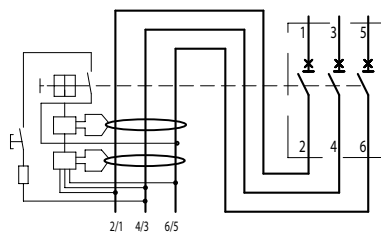

DDA 204 B type

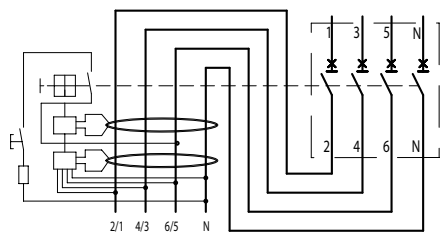

DDA 802

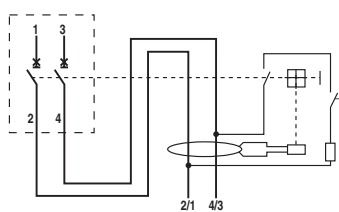

DDA 803

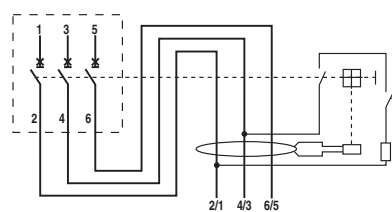

DDA 804

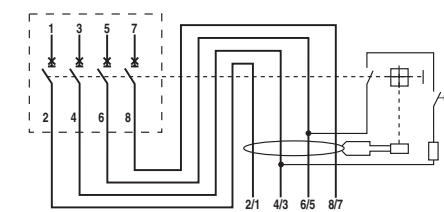

2CSC400442F0202

RCBOs

DS201

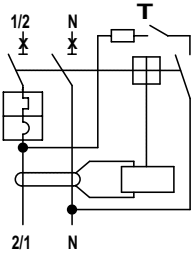

DS202C

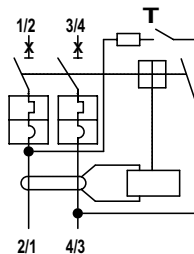

DS 202

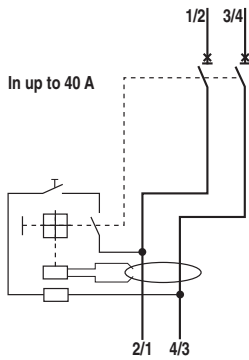

DS 203

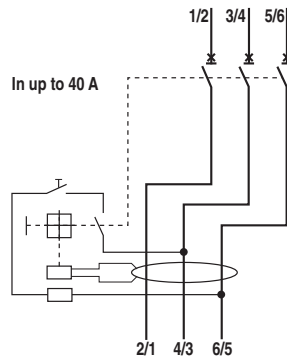

DS 204

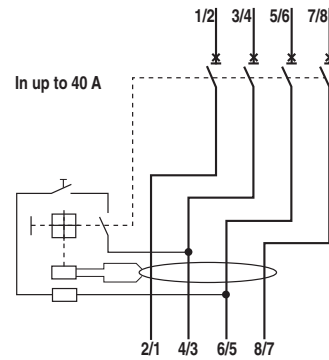

DS 202

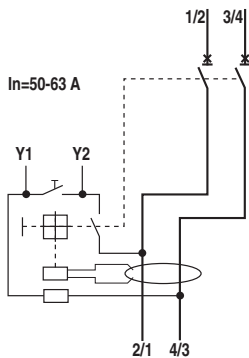

DS 203

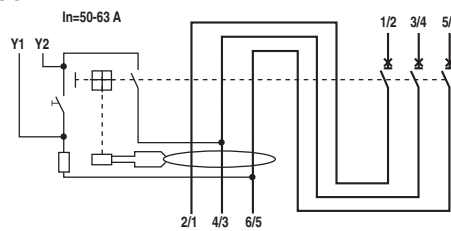

DS 204

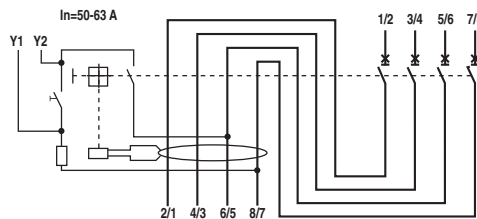

2CSC400443F0202

RD2 RESIDUAL CURRENT MONITORS

They operate combined with appropriate toroidal transformers (in 9 different diameters).

The relay can command the tripping of the protection circuit-breaker release, thus opening the circuit.

According to the IEC 62020 Standard, these relays are “A Type”. They are sensitive to leakage sinusoidal currents and to leakage pulsating currents with direct components. Thus they can be defined as “A type”.

More technical characteristics

Calibration tolerances	- sensitivity	+0% -50%
	- time	+0% -50%
Power consumption	[W]	0.45 at 48 V AC/DC 1.2 at 110 V AC/DC 3.4 at 230 V AC 11 at 400 V AC
Dielectric test voltage at ind. freq. for 1 min.	[kV]	2.5
Max. peak current with 8/20 µs wave	[A]	5000
Installation position		any
Protection degree		IP20



2CSC400321F0201

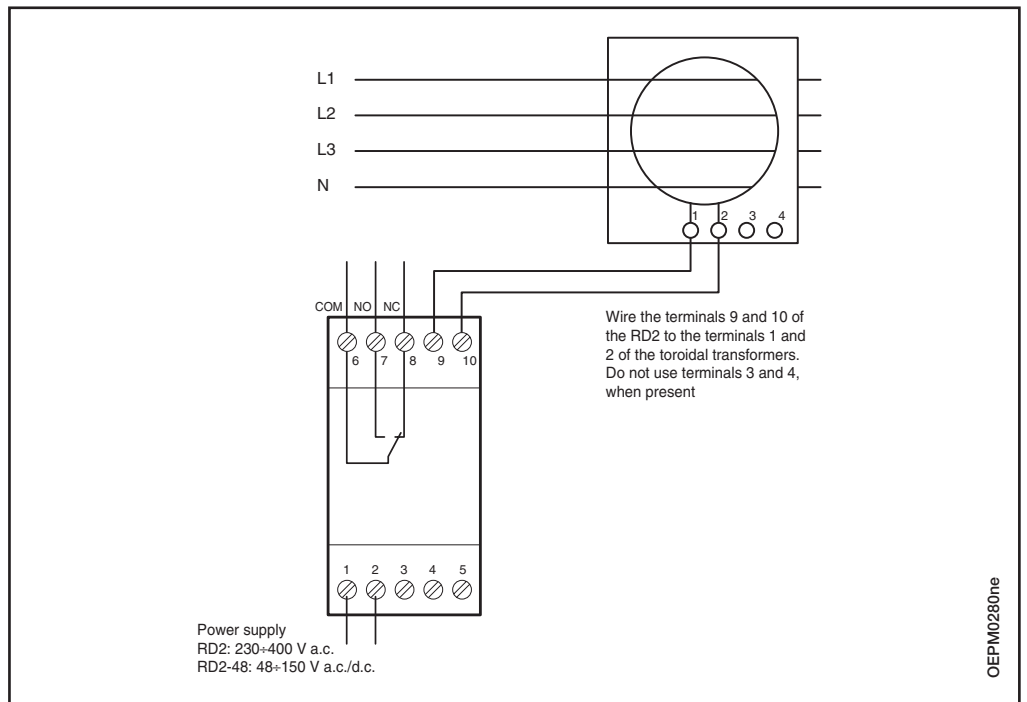

OEPM0280ne

RD3 ELECTRONIC RESIDUAL CURRENT RELAY

RD3 is a residual current device that in combination with a toroidal transformer is able to detect and evaluate earth fault current. If used in combination with a shunt-trip or undervoltage release, it can realize the opening of a circuit breaker ensuring earth leakage current protection.

RD3



RD3M



RD3P



Toroid - relay connection

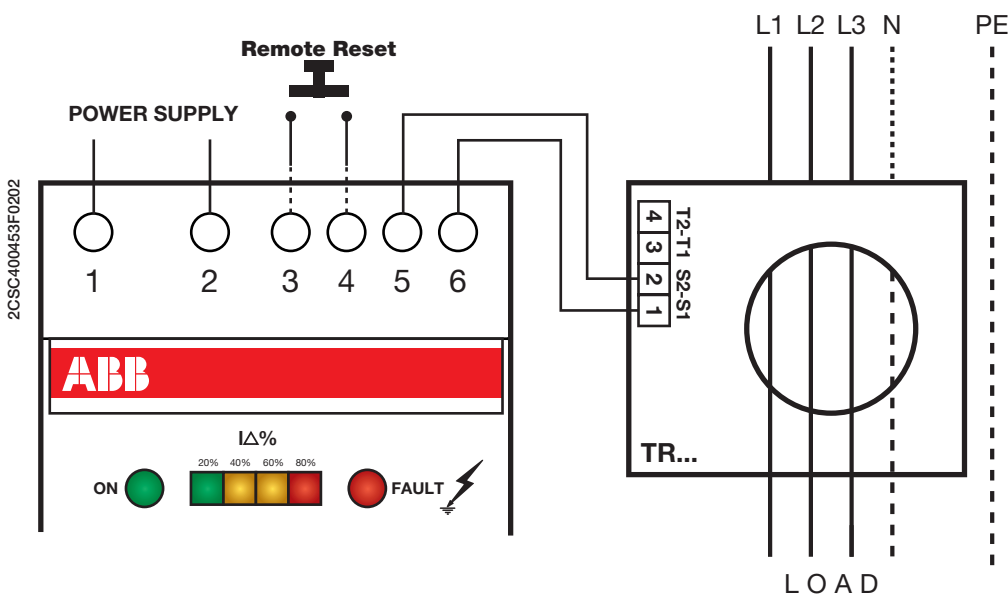

Toroid selection table in according to IEC/EN 60947-2 Annex-M (RD3, toroid and MCCBs up to T5)

Model	"Standard" Use				Use with iron screen			
	Toroid diameter	Max. cable section (4x)	Max. current (1x)	Min. current measurable	Iron screen diameter	Iron screen length	Max. current (1x)	Min. current measurable
	[mm]	[mm ²]	[A]	[mA]	[mm]	[mm]	[A]	[mA]
TRM	29	25	65	25	25	80	85	25
TR1	35	35	75	25	30	80	110	25
TR2	60	50	85	25	30	80	150	25
TR3	80	95	160	100	40	80	225	100
TR4	110	240	250	100	55	250	400	100
TR5	210	400	630	250	75	250	800	250
TR160	160	400	400	250	75	250	630	250
TR160/A	160	400	400	500	75	250	630	500
TR4/A	110	240	250	250	55	250	400	250
TR5/A	210	400	630	500	75	250	800	500

Setting of residual operating current and trip time delay.

Using the rotary selectors on the front of the device, it is possible to adjust the residual operating current and the trip time delay.

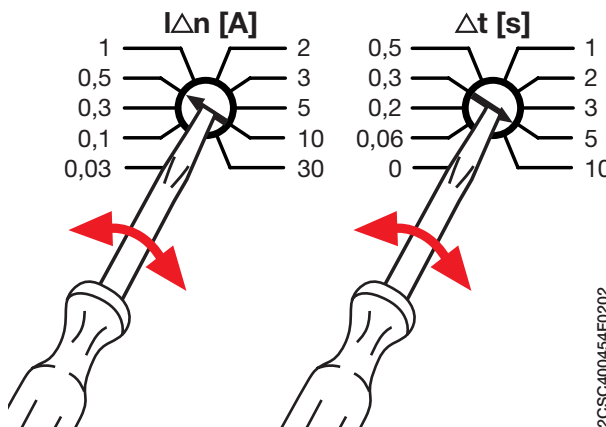

Adjustment of residual operating current ($I_{\Delta n}$ [A]) and trip time delay (Δt [s]).

2CSC400454F0202

Main features

Pre-alarm

Placing the dip-switch in the ON position enables the pre-alarm function: the output contact on terminals 7 8 9 will change state in the event of a residual current exceeding 60% I_{Δ} .

Autoreset

Placing the dip-switch in the ON position enables the automatic Reset function: the Relay OUTPUT contacts revert to their original state once the fault condition ceases.

Fail-safe

Built into the device (positive safety). In case of absence of supply to the device RD3 the output contact on terminals 10 11 12 will change state as shown in the figures.

Model	Pre-alarm	Autoreset	Fail-safe
RD3			■
RD3M	■		■
RD3P	■	■	■

RD3, RD3M, RD3P contacts position

When the toroidal transformer is connected the output contacts work as shown

RD3 is not supplied

RD3 is supplied

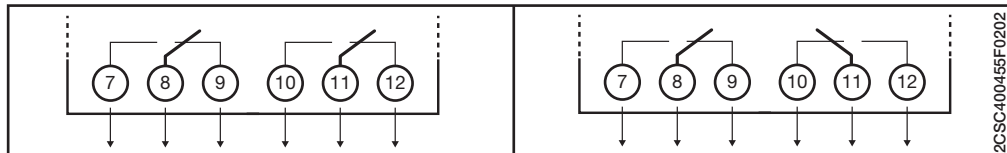

RD3

FAIL-SAFE (positive safety device)

When RD3 is not supplied the output contacts will switch as shown

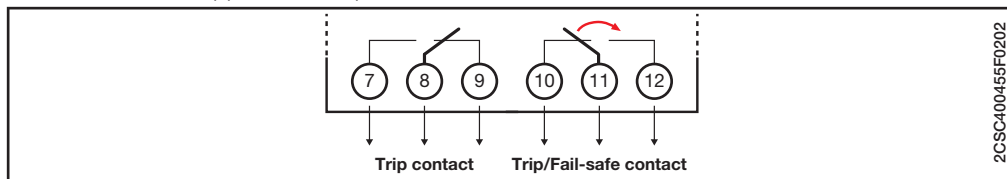

TRIP

The residual current level is higher than $I_{\Delta n}$ threshold

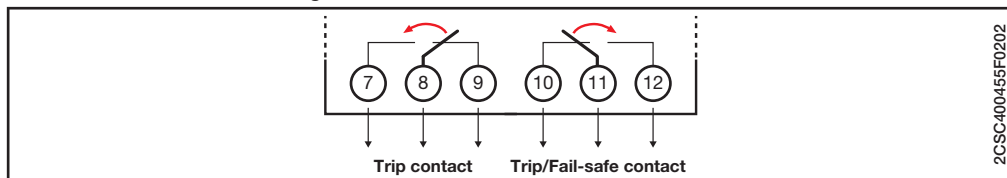

RD3 M

PRE ALARM ON



TRIP

The residual current level is higher than $I_{\Delta n}$ threshold

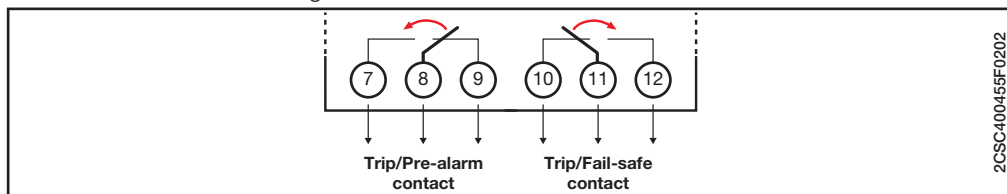

The residual current level is higher than 60% $I_{\Delta n}$ threshold

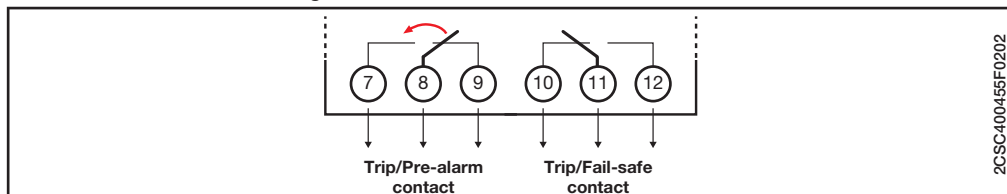

FAIL-SAFE (positive safety device)

When RD3 is not supplied the output contacts will switch as shown

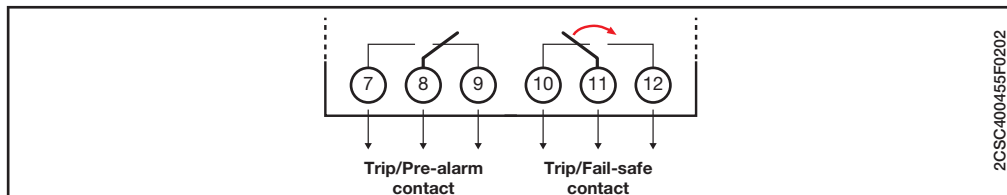

PREALARM OFF



The RD3M output contacts work like basic RD3

RD3 P

AUTORESET ON



The output contacts will revert to the stand-by status when the fault status ends

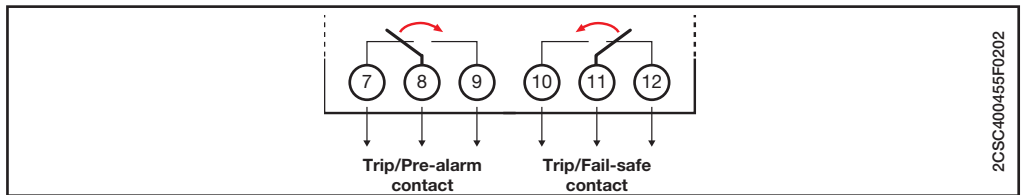

PRE ALARM ON



TRIP

The residual current level is higher than $I_{\Delta n}$ threshold

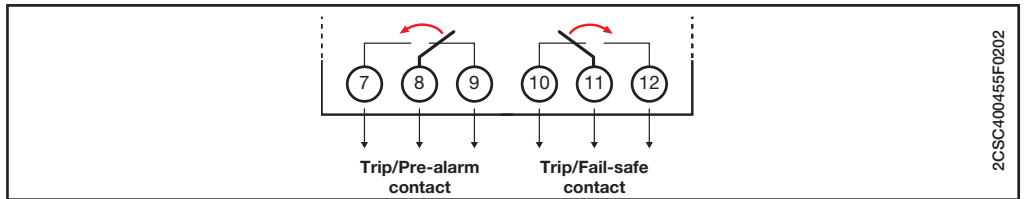

The residual current level is higher than 60% $I_{\Delta n}$ threshold

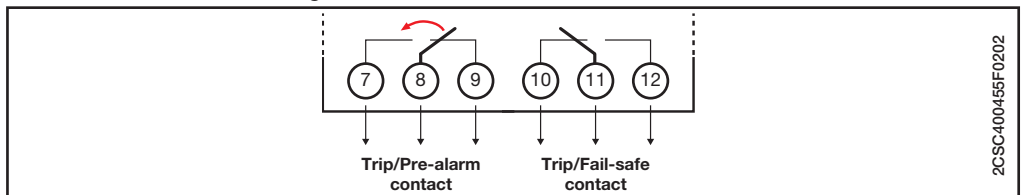

FAIL-SAFE (positive safety device)

When RD3 is not supplied the output contacts will switch as shown

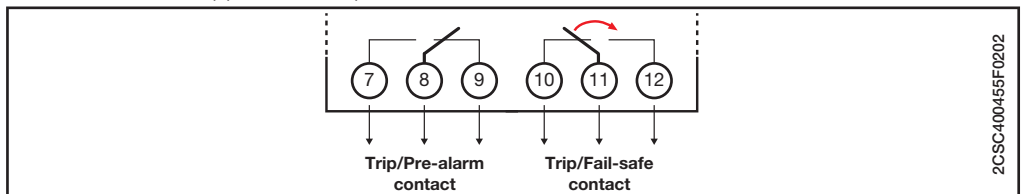

PREALARM OFF



The RD3P output contacts work like basic RD3

Indicators

RD3

RD3M

RD3P



Stand by			
Fault			
Absent connection with toroid			

Connection with shunt trip when the current is activated

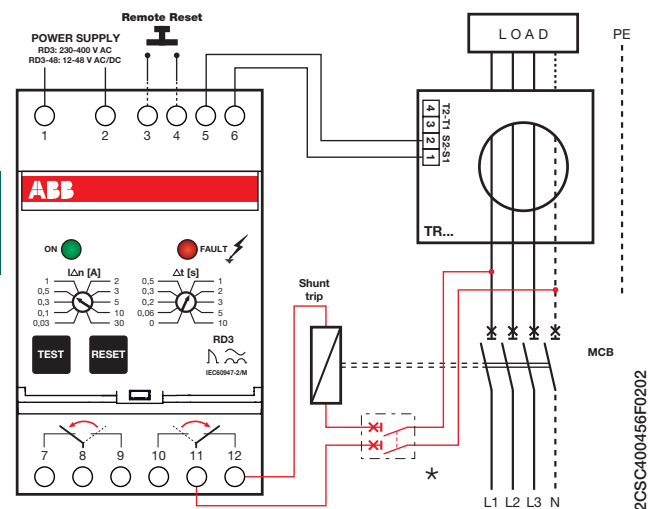

Connection to undervoltage release

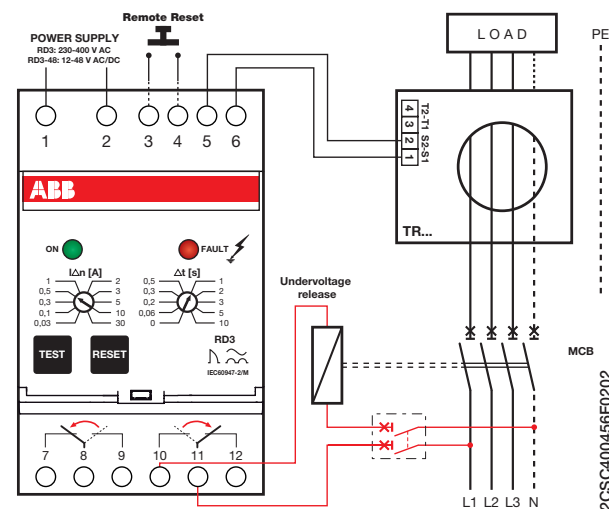

* The residual current protection is not active when this circuit breaker is switch-off

Test

To perform the relay test, press the button on the front.
The relay can be reset via the front button or a remote button, as shown in the figure:

Test

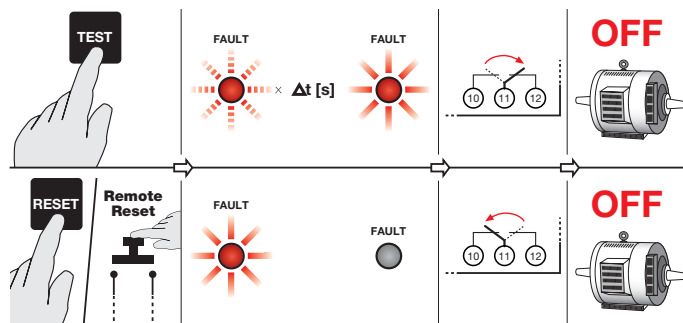

2CSC400457F0202

On RD3P version, a no trip test can also be performed by simultaneously pressing the front test and reset buttons for 3 seconds. In this case, the output contacts will not switch, as shown in the figure below:

Test NO TRIP

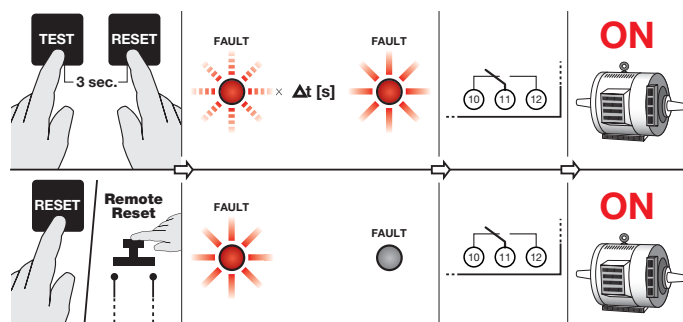

2CSC400457F0202

Associated circuit breakers (and relative releasers)

- Tmax range from T1 to T5, In up to 630 A, Ue up to 690 V, with UVR undervoltage release or SOR shunt opening release
- pro M Compact S200 range with In up to 63 A, Ue up to 440 V, with S 2C-A shunt trip or S 2C-UA undervoltage release

Tripping time (RD3 output relay switching time), cumulative time (with associate circuit breakers), non-trip time limit:

Time selection Δt [s]	$1 \Delta n$			$2 \Delta n$		$5 \Delta n$		$10 \Delta n$	
	tripping time \leq [s]	cumulative time with associate circuit breaker \leq [s]	time limit for non-trip [s]	tripping time \leq [s]	cumulative time with associate circuit breaker \leq [s]	tripping time \leq [s]	cumulative time with associate circuit breaker \leq [s]	tripping time \leq [s]	cumulative time with associate circuit breaker \leq [s]
0	0.03	0.3	-	0.03	0.15	0.015	0.04	0.015	0.04
0.06	0.09	0.5	0.06	0.09	0.2	0.09	0.15	0.09	0.15
0.2	0.2+15%	-	0.2	0.2+15%	-	0.2+15%	-	0.2+15%	-
0.5	0.5+15%	-	0.5	0.5+15%	-	0.5+15%	-	0.5+15%	-
1	1+15%	-	1	1+15%	-	1+15%	-	1+15%	-
2	2+15%	-	2	2+15%	-	2+15%	-	2+15%	-
3	3+15%	-	3	3+15%	-	3+15%	-	3+15%	-
5	5+15%	-	5	5+15%	-	5+15%	-	5+15%	-
10	10+15%	-	10	10+15%	-	10+15%	-	10+15%	-



2CSC400400F0202

FRONT PANEL RESIDUAL CURRENT RELAYS

RD148

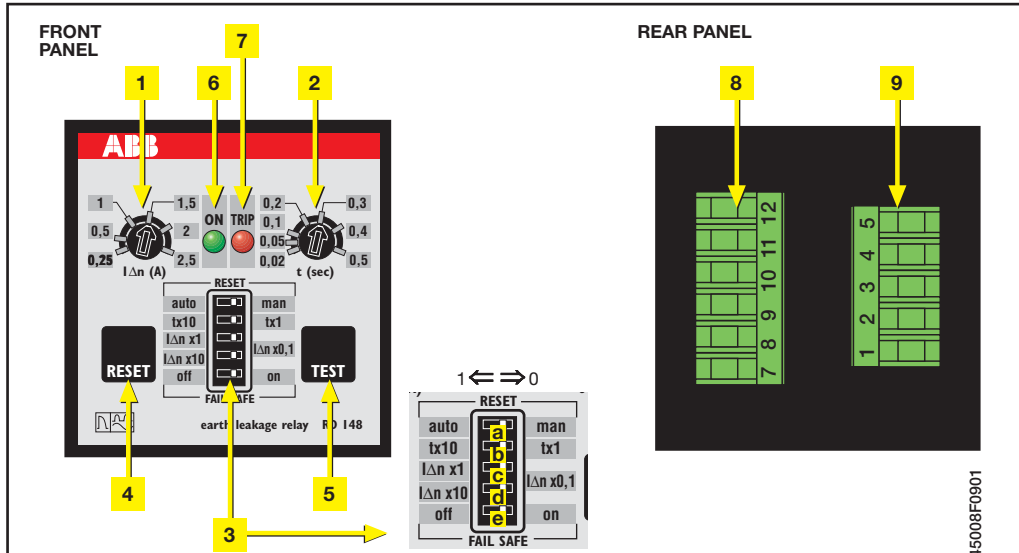

2CSC445008F0901

- 1 Potentiometer for adjusting tripping current
- 2 Potentiometer for adjusting tripping time
- 3 Programming microswitches
 - a. Reset mode setting. In position 1 automatic reset; in position 0 manual reset
 - b. Tripping time multiplication constant: 1 → t x 10 ; 0 → t x 1
 - c,d. Tripping current multiplication constant
 - c,d in position 0 → IΔ x 0,1
 - c in position 1, d in position 0 → IΔ x 1
 - c,d in position 1 → IΔ x 10
- e. Fail safe function
 - e in position 1 → relay normally de-energized
 - e in position 0 → relay normally energized (fail safe)
- 4 Manual reset pushbutton
- 5 Test pushbutton
- 6 Green led indicating auxiliary supply presence
- 7 Red led indicating relay has been tripped
- 8 Output terminals
- 9 Auxiliary power supply and external toroidal terminals

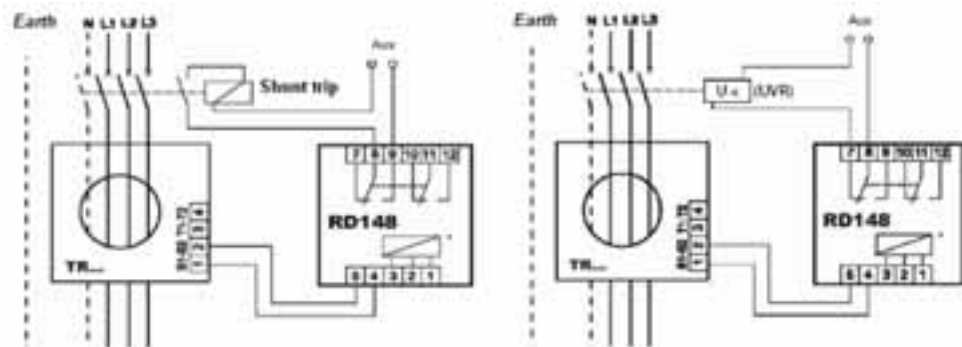

Example of wiring diagram: shunt trip connection and undervoltage release (fail safe OFF)

Auxiliary power supply:

RD148-230

Terminals 1-3 = 220-240 V a.c.
Terminals 2-3 = 110-125 V a.c./d.c.

RD148-24

Terminals 1-3 = 48 V a.c./d.c.
Terminals 2-3 = 24 V a.c./d.c.

RD172

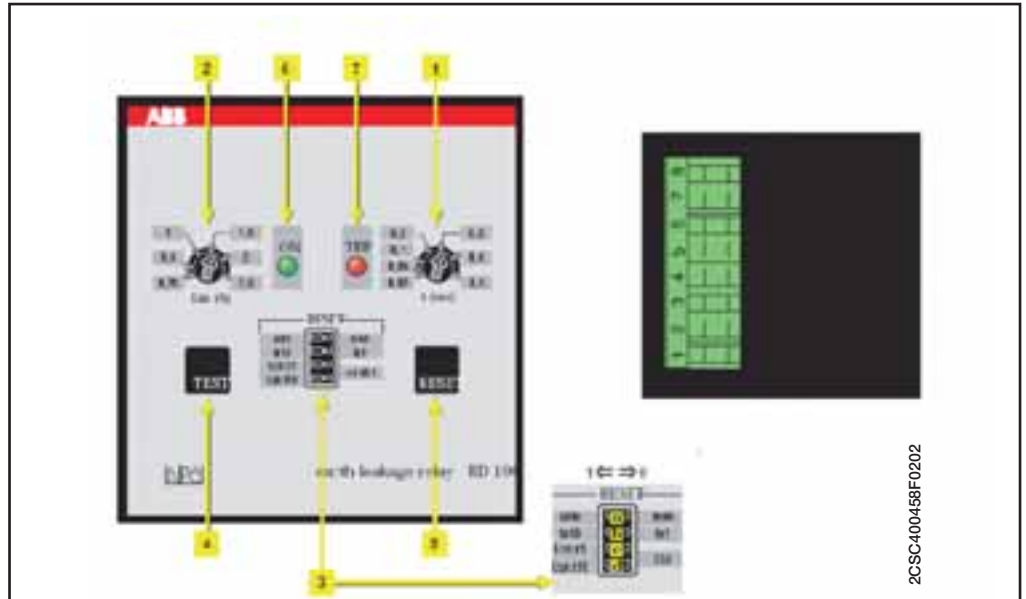

2CSC400458F0202

- 1 Potentiometer for adjusting tripping time
- 2 Potentiometer for adjusting tripping current
- 3 Programming microswitches
 - a. Reset mode setting.
in position 1 automatic reset;
in position 0 manual reset
 - b. Tripping time multiplication constant:
1 → t x 10 ; 0 → t x 1
- c,d. Tripping current multiplication constant
 - c,d in position 0 → IΔ x 0,1
 - c in position 1, d in position 0 → IΔ x 1
 - c,d in position 1 → IΔ x 10
- 4 Test pushbutton
- 5 Manual reset pushbutton
- 6 Green led indicating auxiliary supply presence
- 7 Red led indicating relay has been tripped

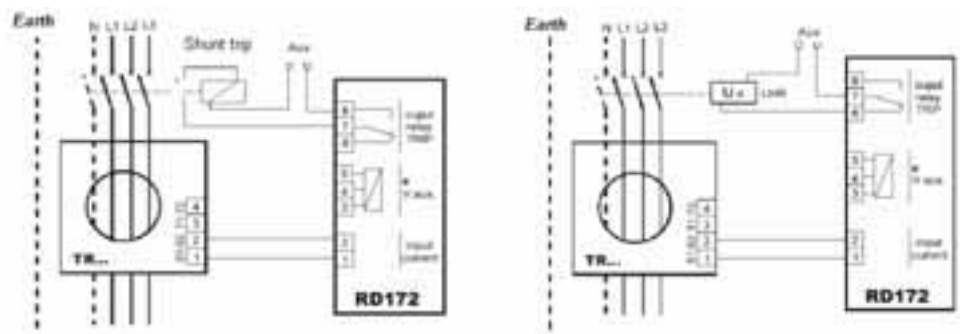

Example of wiring diagram: shunt trip connection and undervoltage release (fail safe OFF)

Auxiliary power supply:

RD172-230
Terminals 3-5 = 220-240 V a.c.
Terminals 3-4 = 110-125 V a.c./d.c.

RD172-24
Terminals 3-5 = 48 V a.c./d.c.
Terminals 3-4 = 24 V a.c./d.c.

RD196

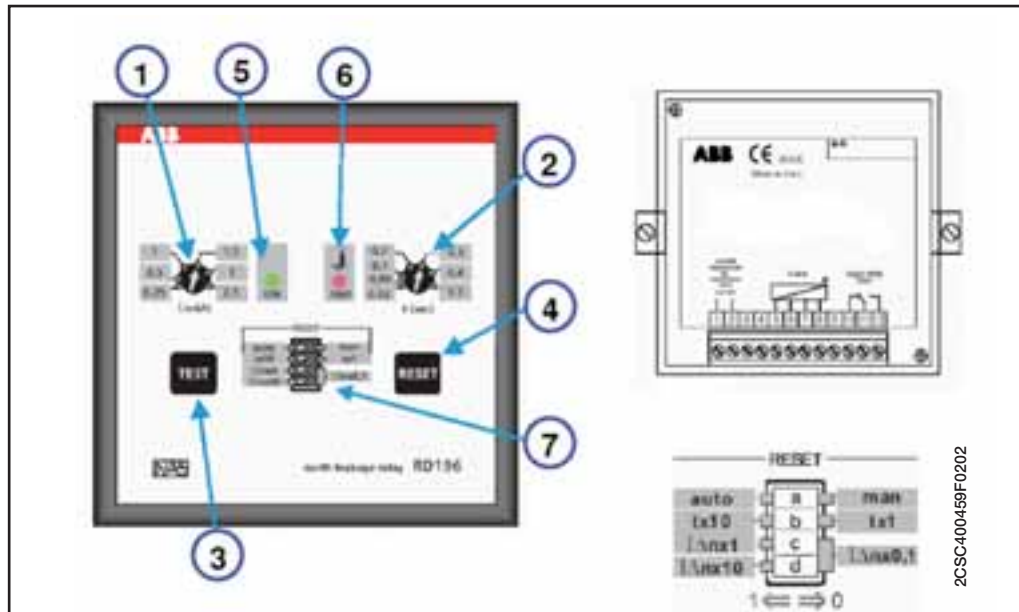

- 1 Potentiometer for adjusting tripping current
- 2 Potentiometer for adjusting tripping time
- 3 Test pushbutton
- 4 Manual reset pushbutton
- 5 Green led indicating auxiliary supply presence
- 6 Red led indicating relay has been tripped
- 7 Programming microswitches
 - a. Reset mode setting.
In position 1 automatic reset;
in position 0 manual reset
 - b. Tripping time multiplication constant:
1 → t x 10 ; 0 → t x 1
 - c,d. Tripping current multiplication constant
c,d in position 0 → I_Δ x 0,1
c in position 1, d in position 0 → I_Δ x 1
c,d in position 1 → I_Δ x 10

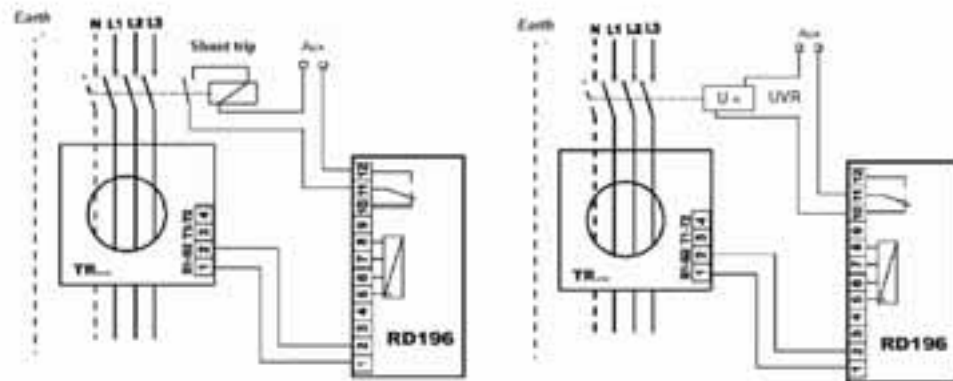

Example of wiring diagram: shunt trip connection and undervoltage release (fail safe OFF)

Auxiliary power supply:

RD196-230

Terminals 5-6 = 115 V a.c./d.c.
Terminals 5-7 = 230 V a.c./d.c.
Terminals 5-8 = 400 V a.c.

RD196-24

Terminals 5-6 = 25 V a.c./d.c.
Terminals 5-7 = 48 V a.c./d.c.

2CSC400459F0202

RD272

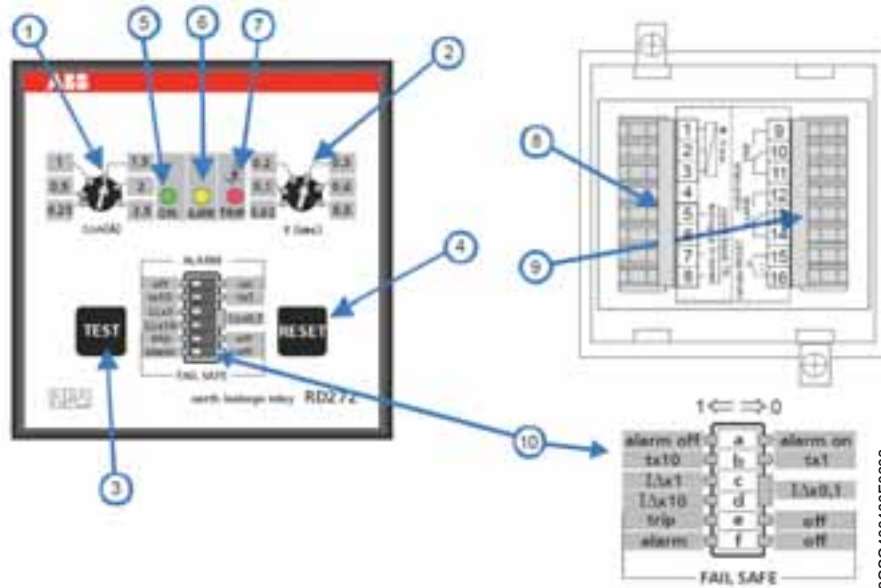

- 1 Potentiometer for adjusting tripping current
- 2 Potentiometer for adjusting tripping time
- 3 Test pushbutton
- 4 Manual reset pushbutton
- 5 Green led indicating auxiliary supply presence
- 6 Yellow led indicating alarm presence (the residual current has exceeded 60% of the programmed threshold)
- 7 Red led indicating relay has been tripped
- 8 Terminals for auxiliary supply and toroidal connection
- 9 Terminals for output relay and remote reset/auto reset connection
- 10 Programming microswitches:
 - a. 1 → alarm off, 0 → alarm on
 - b. tripping time multiplication constant

- 1 → t x 10 ; 0 → t x 1
- c,d. tripping current multiplication constant
 - c,d in position 0 → IΔ x 0,1
 - c in position 1, d in position 0 → IΔ x 1
 - c,d in position 1 → IΔ x 10
- e 1 → TRIP output relay normally energized (fail safe)
0 → TRIP output relay normally de-energized
- f 1 → ALARM (TRIP2) output relay normally energized (fail safe)
0 → ALARM (TRIP2) output relay normally de-energized

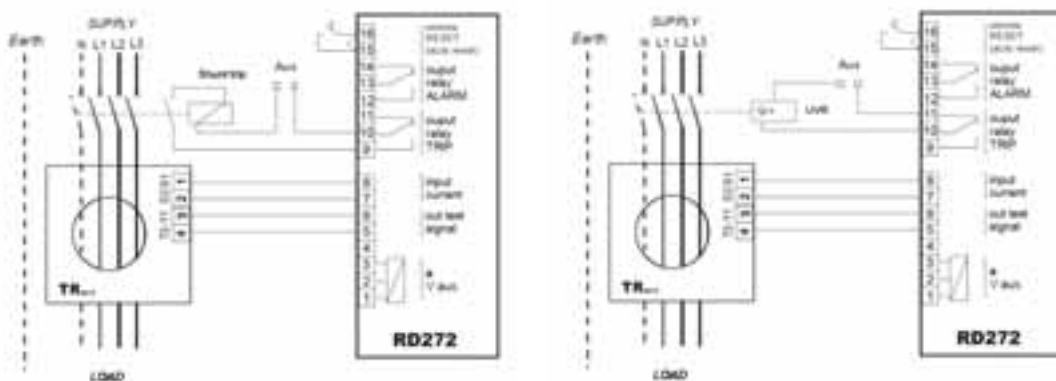

Example of wiring diagram: shunt trip connection and undervoltage release (fail safe OFF)

Auxiliary power supply:

RD272-230
Terminals 2-3 = 100-125 V a.c.
Terminals 1-2 = 220-240 V a.c.
Terminals 1-3 = 380-415 V a.c.

RD272-115
Terminals 2-3 = 100-125 V a.c./d.c.

RD272-24
Terminals 2-3 = 24 V a.c./d.c.
Terminals 1-3 = 48 V a.c./d.c.

Remote reset connection or automatic reset:
Terminals 15-16 realize the remote reset function. Short circuit the terminals to obtain the auto reset function.

RD296

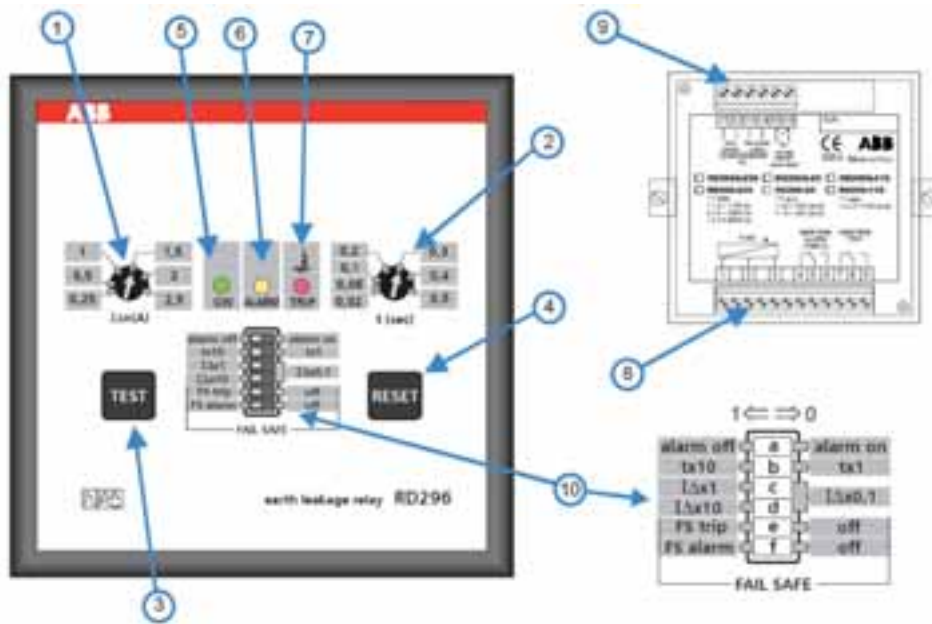

2CSC400461 F0202

- 1 Potentiometer for adjusting tripping current
- 2 Potentiometer for adjusting tripping time
- 3 Test pushbutton
- 4 Manual reset pushbutton
- 5 Green led indicating auxiliary supply presence
- 6 Yellow led indicating alarm presence (the residual current has exceeded 60% of the programmed threshold)
- 7 Red led indicating relay has been tripped
- 8 Terminals for auxiliary supply and output relay contact connection
- 9 Terminals for toroid connection and remote reset/auto reset connection

10 Programming microswitches:

- a. 1 → alarm off, 0 → alarm on
- b. tripping time multiplication constant
1 → $t \times 10$; 0 → $t \times 1$
- c,d. tripping current multiplication constant
c,d in position 0 → $I\Delta \times 0,1$
c in position 1, d in position 0 → $I\Delta \times 1$
c,d in position 1 → $I\Delta \times 10$
- e. 1 → TRIP output relay normally energized (fail safe)
0 → TRIP output relay normally de-energized
- g. 1 → ALARM (TRIP2) output relay normally energized (fail safe)
0 → ALARM (TRIP2) output relay normally de-energized

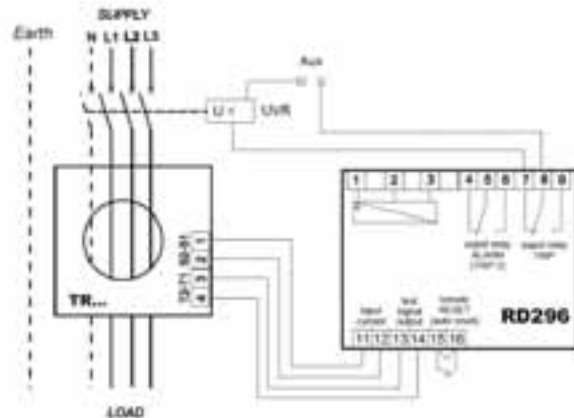
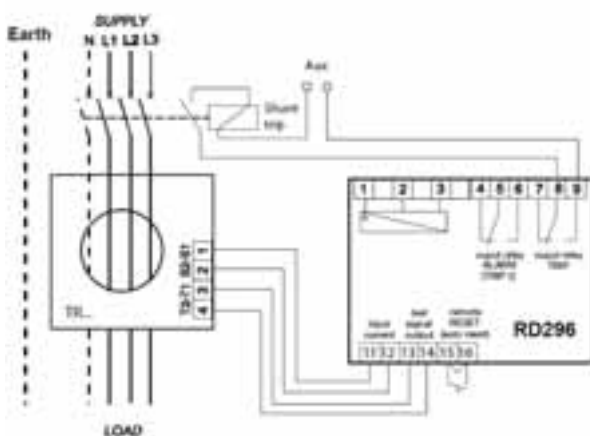

Example of wiring diagram: shunt trip connection and undervoltage release (fail safe OFF)

Auxiliary power supply:

RD296-230

Terminals 5-6 = 115 V a.c./d.c.
Terminals 5-7 = 230 V a.c./d.c.
Terminals 5-8 = 400 V a.c.

RD296-24

Terminals 5-6 = 25 V a.c./d.c.
Terminals 5-7 = 48 V a.c./d.c.

RD296-115

Terminals 1-2 = 100-125 V a.c./d.c.

Remote reset connection or automatic reset:

Terminals 15-16 realize the remote reset function. Short circuit the terminals to obtain the auto reset function.

RD296 S

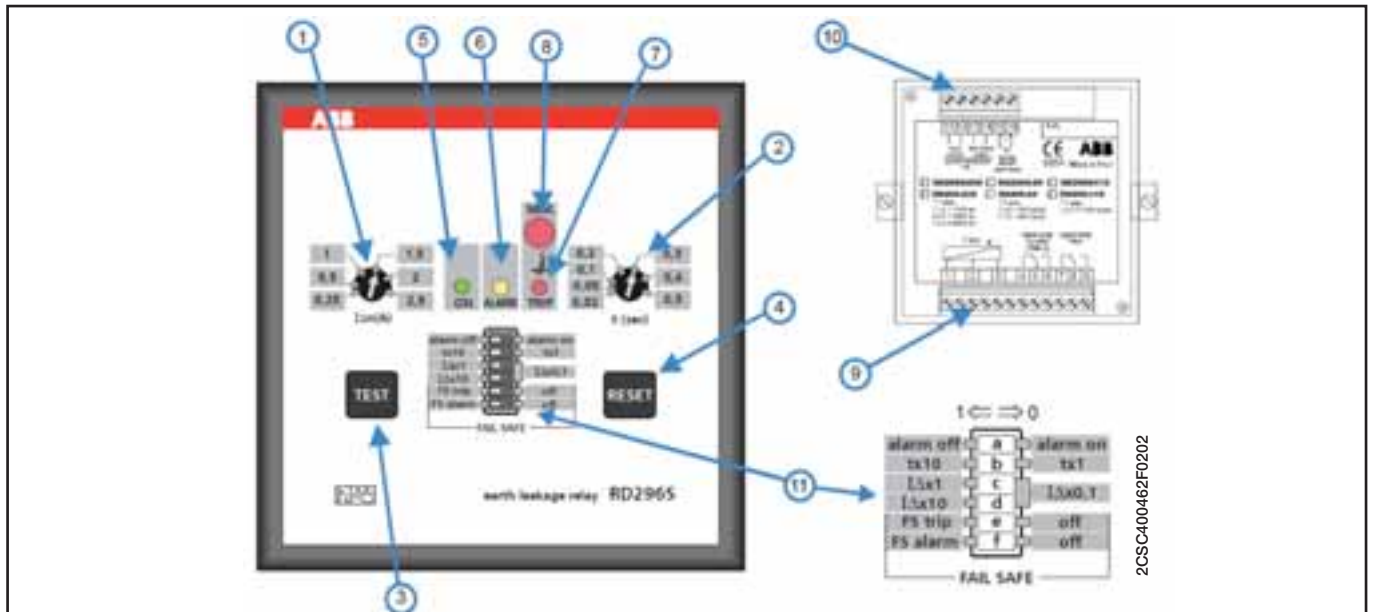

- 1 Potentiometer for adjusting tripping current
- 2 Potentiometer for adjusting tripping time
- 3 Test pushbutton
- 4 Manual reset pushbutton
- 5 Green led indicating auxiliary supply presence
- 6 Yellow led indicating alarm presence (the residual current has exceeded 60% of the programmed threshold)
- 7 Red led indicating relay has been tripped
- 8 Memory led indicating relay has been tripped (only manual reset)
- 9 Removable terminals for auxiliary supply and output relay contact connection
- 10 Removable terminals for toroid connection and remote reset/automatic reset connection

- 11 Programming microswitches:
 - a. 1 → alarm off, 0 → alarm on
 - b. tripping time multiplication constant 1 → $t \times 10$; 0 → $t \times 1$
 - c,d. tripping current multiplication constant
 - c,d in position 0 → $I\Delta \times 0,1$
 - c in position 1, d in position 0 → $I\Delta \times 1$
 - c,d in position 1 → $I\Delta \times 10$
 - e. 1 → TRIP output relay normally energized (fail safe)
0 → TRIP output relay normally de-energized
 - h. 1 → ALARM (TRIP2) output relay normally energized (fail safe)
0 → ALARM (TRIP2) output relay normally de-energized

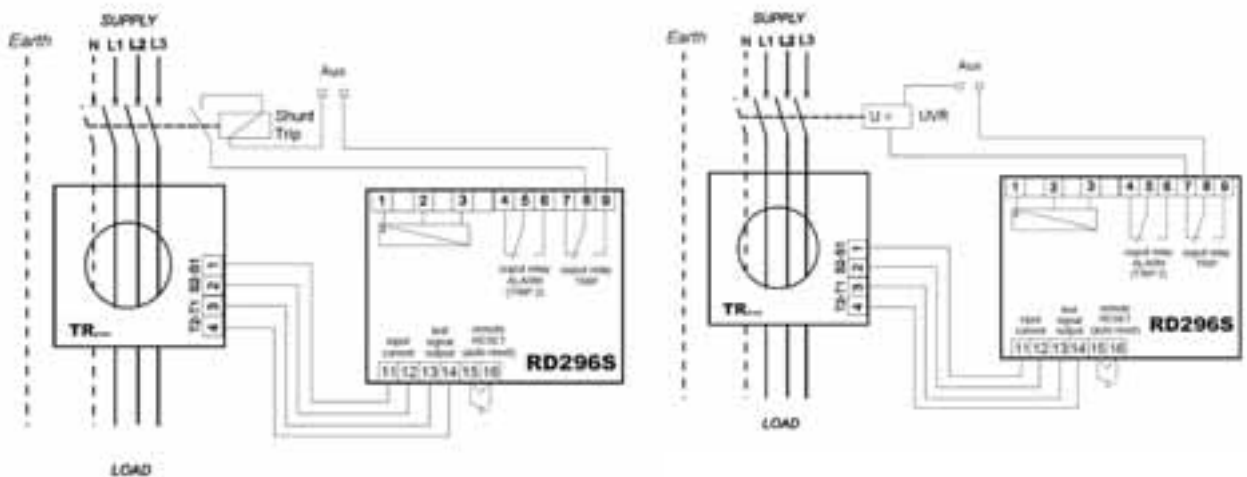

Example of wiring diagram: shunt trip connection and undervoltage release (fail safe OFF)

Auxiliary power supply:

RD296 S-230
Terminals 1-2 = 100-125 V a.c.
Terminals 2-3 = 220-240 V a.c.
Terminals 1-3 = 380-415 V a.c.

RD296 S-115
Terminals 1-2 = 100-125 V a.c./d.c.

RD296 S-24
Terminals 1-2 = 24 V a.c./d.c.
Terminals 1-3 = 48 V a.c./d.c.

Remote reset connection or automatic reset:
Terminals 15-16 realize the remote reset function. Short circuit the terminals to obtain the auto reset function.

RD296-DIG

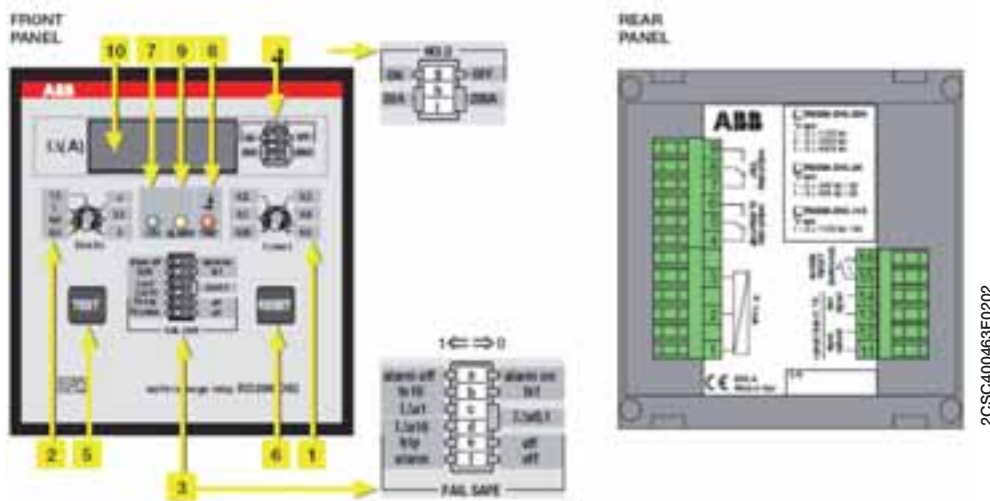

2CSC400463F0202

- 1 Potentiometer for adjusting tripping time
- 2 Potentiometer for adjusting tripping current
- 3 Programming microswitch
 - a. enable/disable alarm
in position 1 → alarm disabled
in position 0 → alarm enabled (the alarm led switch on when the ground fault current has exceeded 60% of the programmed threshold).
 - b. select constant for adjusting the time
in position 1 → $t \times 10$
in position 0 → $t \times 1$
 - c,d. select constant for adjusting the current
c,d in position 1 → $I \times 10$
c in position 1, d in position 0 → $I \times 1$
c,d in position 0 → $I \times 0,1$
- e. enable/disable positive safety on tripped relay
in position → 1 positive safety is enabled; trip output contact normally energized
in position → 0 positive safety is disabled; trip output contact normally de-energized
- f. enable/disable positive safety on alarm
in position → 1 positive safety is enabled; alarm output contact normally energized
in position → 0 positive safety is disabled; alarm output contact normally de-energized
- 4 Programming microswitch
 - g. enable/disable residual current memory on display
in position → 1 memory is enabled (it stops the visualization of the tripping current)
in position → 0 memory is disabled (display values in real time)
 - h,i. select scale for display
h,i in position → 1 selects the 20 A range
h,i in position → 0 selects the 200 A range
- 5 Test button
- 6 Manual reset button
- 7 Green led indicating auxiliary supply presence
- 8 Yellow led indicating alarm presence (the residual current has exceeded 60% of the programmed threshold)
- 9 Red led indicating relay has been tripped
- 10 4 digit display for residual current visualization

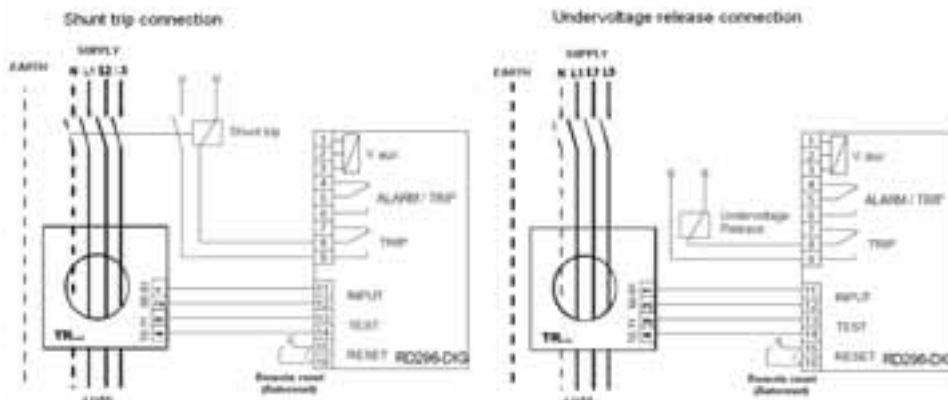

Example of wiring diagram: shunt trip connection and undervoltage release (fail safe OFF)

Auxiliary power supply:

RD296-DIG-230

Terminals 1-2 = 110-127 V a.c.
Terminals 2-3 = 220-240 V a.c.
Terminals 1-3 = 380-415 V a.c.

RD296 DIG-115

Terminals 1-2 = 100-125 V a.c/d.c.

RD296 DIG-24

Terminals 1-2 = 24 V a.c/d.c.
Terminals 1-3 = 48 V a.c/d.c.

Remote reset connection or automatic reset:

Terminals 15-16 realize the remote reset function. Short circuit the terminals to obtain the auto reset function.

Toroidal transformers

More technical characteristics

	TRM	TR1	TR2	TR3	TR4	TR4A	TR160	TR160A	TR5	TR5A
Core	closed	closed	closed	closed	closed	open	closed	open	closed	open
Available internal diameter [mm]	29	35	60	80	110	110	160	160	210	210
Weight [kg]	0.17	0.22	0.28	0.45	0.52	0.6	1.35	1.6	1.45	1.85
Minimum measurable current [mA]	30	30	30	100	100	300	300	500	300	500
Installation position	Any									
Operating temperature [°C]	-10...+70									
Storage temperature [°C]	-20...+80									
Transformation ratio	500/1									
Dielectric test voltage at industrial freq. for 1 min. [kV]	2.5									
Max. insulating voltage [V a.c.]	1000									
Max. thermal overload [kA]	40/1 sec.									
Connections	Screw terminal boards, max. section 2.5 mm ²									
Protection degree	IP20									

Generality

They must be mounted with residual current monitors upstream the lines or loads to be protected; all active conductors (phases and neutral) of single-phase as well as of three-phases lines must pass through them.

In this way these devices perform the vector sum of line currents detecting the possible homopolar differential currents that leak to earth: their core of sheet iron has high magnetic properties that allow to detect even very low leakage currents.

The choice of a toroidal transformer depends on the conductor or on the bar to be used.

It is suggested to use the open versions in case of revamping or upgrading of an existing installation.

Installation

All active conductors can be introduced in the toroidal transformers without the need of respecting any specific sense of introduction (P1-P2 or P2-P1). The output signal must be picked up from terminals 1 (S1) and 2 (S2) and connected to the residual current monitor, while terminals 3 and 4 must be connected to the test output of those relays of FPP range with this function. With RD2 they must remain disconnected. For this connection it is better to use twisted or shielded cables, possibly far from busbars. The minimum recommended section of connection cables should have a maximum resistance of 3 Ω; anyway consider a maximum length of connection of 20 m for 0.5 mm² and of 100 m for 2.5 mm².

For versions with openable core it is necessary to control that the contact surface of the two semi-cores is clean, that bolts are tight and that connection cables connections on both sides are intact.

Connection cables with metallic shielding or armor must be earthed downstream the toroidal transformer; if they run within the transformer they must be earthed in the opposite direction.

In presence of line overcurrents (for ex. motor operation, energizing of transformers, etc.):

- install the toroidal transformer on a straight cable segment

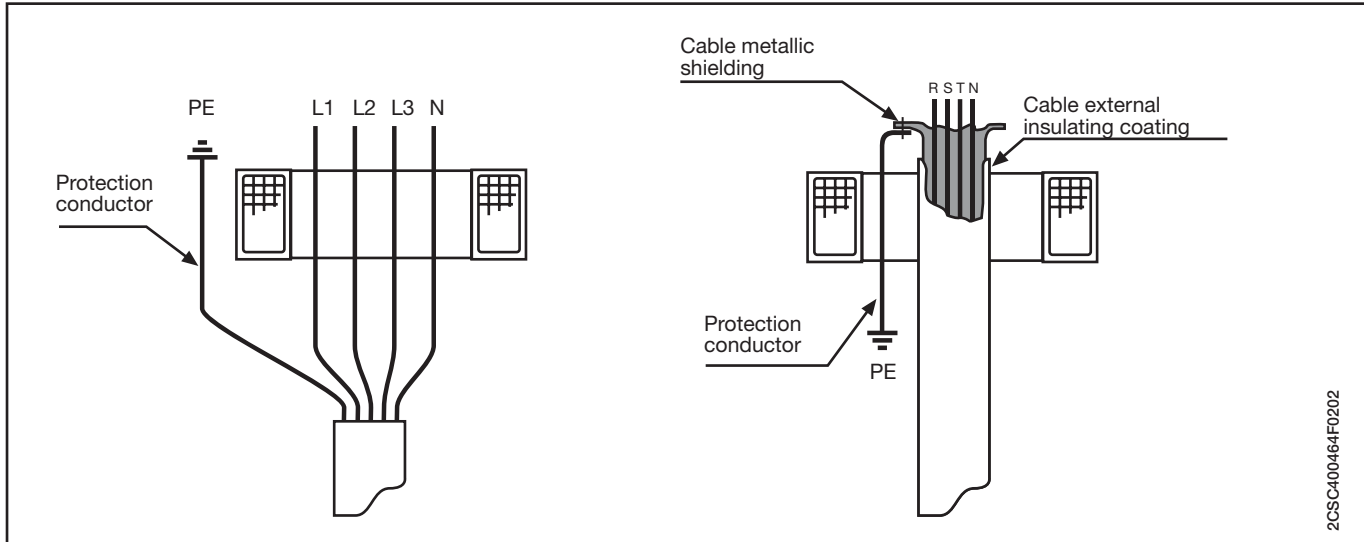

- center cable position within the transformer
- use transformers with a diameter wider than minimum requirements, if necessary with a diameter up to 2 times wider than that of cables.

Coordination table of toroidal transformers acc. to cable section

Copper cables 3 ph + N

Max section per phase	Toroidal Transformer
16 mm ²	TRM
25 mm ²	TR1
50 mm ²	TR2
95 mm ²	TR3
240 mm ²	TR4 or TR4/A
2 x 150 mm ²	TR160 or TR160/A
2 x 185 mm ²	TR5 or TR5/A

2CSC400464F0202

SURGE PROTECTIVE DEVICES OVR RANGE

Terminology of SPD electrical characteristics

10/350 and 8/20 impulse waves

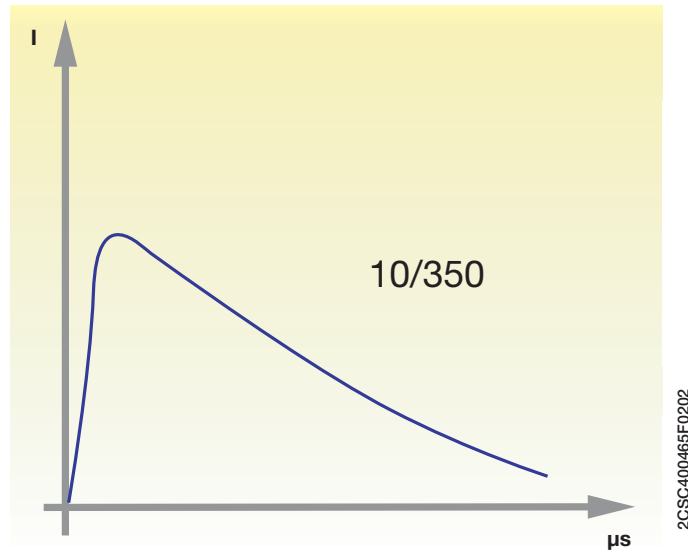

Type 1 Surge Arresters
 I_{imp} : current wave

10/350 wave:

Current waveform which passes through equipment when subjected to an overvoltage due to a direct lightning strike.

Type 1 surge arrester:

Surge arrester designed to run-off energy caused by an overvoltage comparable to that of a direct lightning strike. It has successfully passed testing to the standard with the 10/350 wave (class I test).

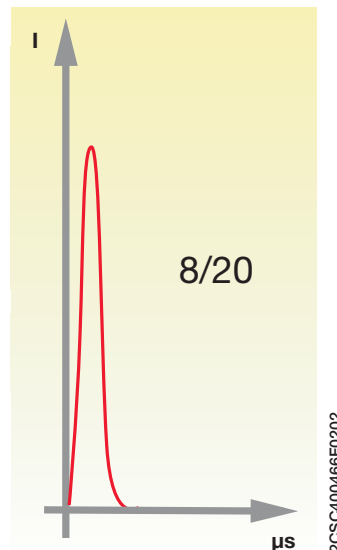

Type 2 Surge Arresters
 I_{max} : current wave

8/20 wave:

Current waveform which passes through equipment when subjected to an overvoltage (low energy).

Type 2 surge arrester:

Surge arrester designed to run-off energy caused by an overvoltage comparable to that of an indirect lightning strike or an operating overvoltage. It has successfully passed testing to the standard with the 8/20 wave (class II test).

Common mode and/or differential mode protection

Common mode

Common mode overvoltages appear between the live conductors and earth, e.g. phase/earth or neutral/earth.

A live conductor not only refers to the phase conductors but also to the neutral conductor. This overvoltage mode destroys equipment connected to earth (class I equipment) and also equipment not connected to earth (class II equipment) which is located near an earthed mass and which does not have sufficient electrical isolation (a few kilovolts). Class II equipment not located near an earthed mass is theoretically protected from this type of attack.

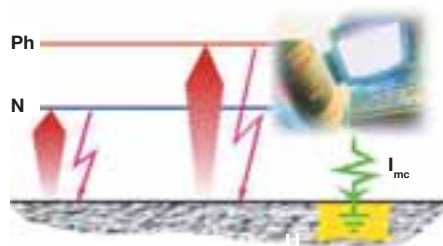

Note:
Common mode overvoltages affect all earthing systems.

2CSC400269F0201

Differential mode

Differential mode overvoltages circulate between live conductors: phase/phase or phase/neutral. These overvoltages have a potentially high damaging effect for all equipment connected to the electrical network, especially 'sensitive' equipment.

Note:
Differential mode overvoltages affect the TT earthing system. These overvoltages also affect the TN-S earthing system if there

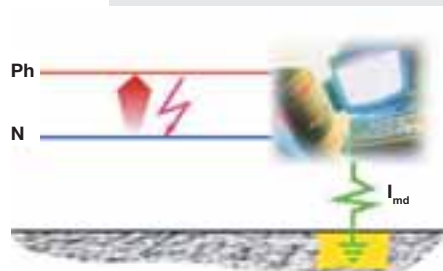

is a considerable difference in the lengths of the neutral cable and the protective cable (PE).

2CSC400269F0201

Note:

The coordination of Type 2 surge arresters is analysed using their respective maximum discharge currents I_{max} (8/20) starting from the installation's incoming switchboard and working towards the equipment which is to be protected, taking into account the progressive reduction in I_{max} .

E.g. 70 kA followed by 40 kA.

All ABB Type 2 surge arresters coordinate between each other by respecting a minimum distance of 1m between them.

Principle of coordination for Surge Protective Devices

After having defined the characteristics of the incoming surge arrester, the protection must be completed with one or more additional surge arresters.

The incoming surge arrester does not provide effective protection for the whole installation by itself.

Certain electrical phenomena can double the protection's residual voltage if cable lengths exceed 10m.

Surge arresters must be coordinated when they are installed (refer to the tables below).

Coordination required if:

The incoming surge arrester does not reach the protection voltage (U_p) by itself.

The incoming surge arrester is more than 10m away from the equipment to be protected.

Recommended solution

Use of modular Type 2 surge arresters.

Coordination between Type 1 and Type 2 surge arrester

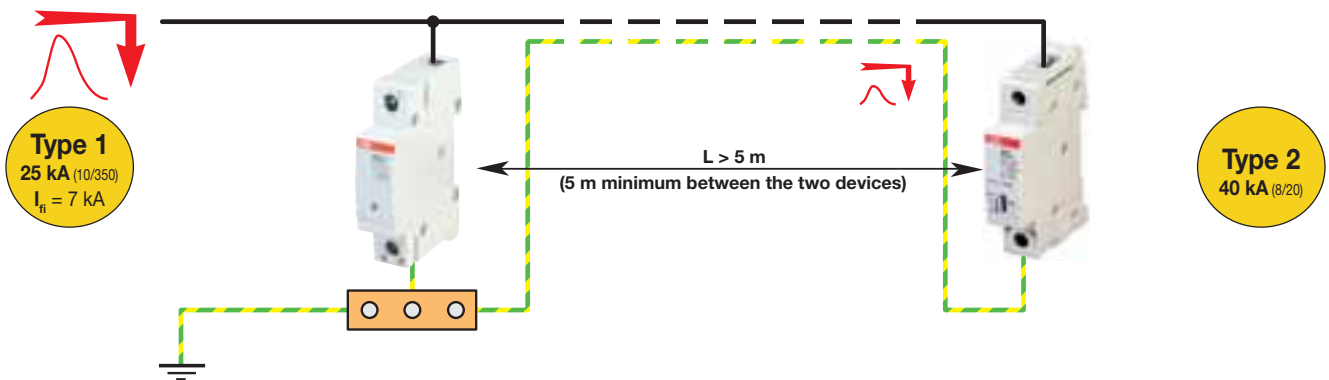
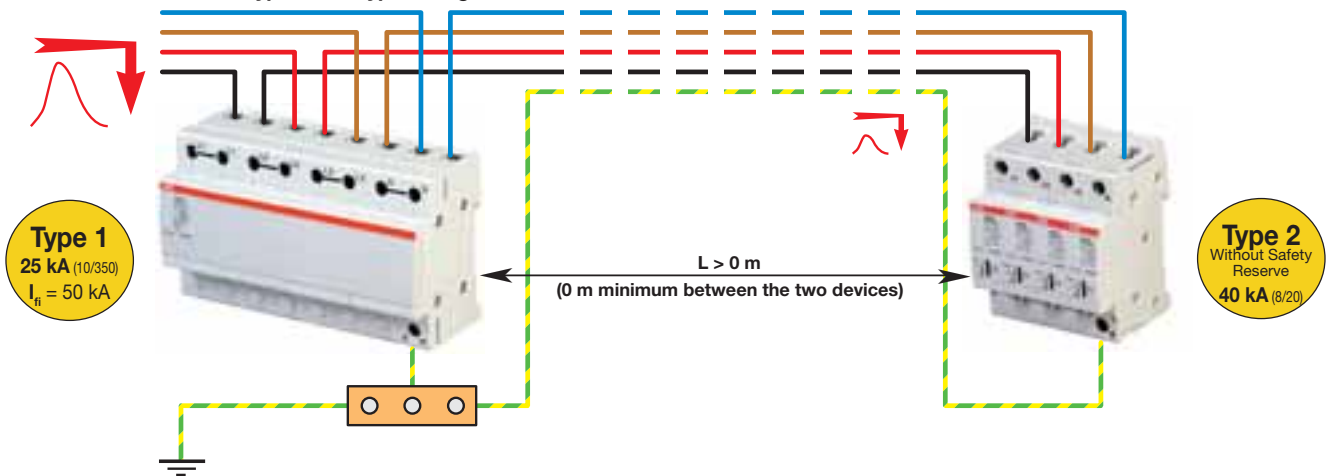

Coordination between Type 2 surge arresters

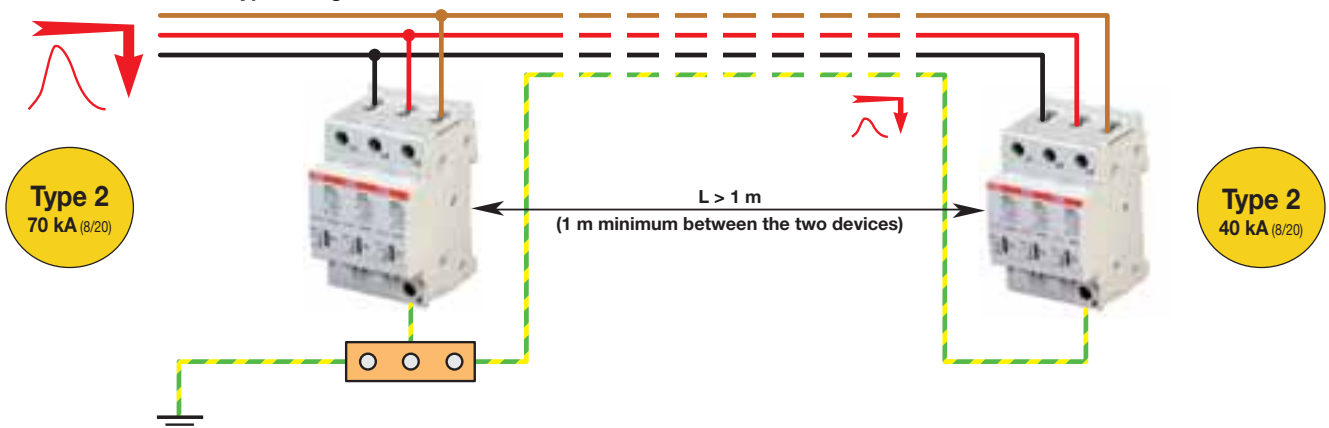

Operating diagrams of Surge Protective Devices

Type 1 internal schematic

Single pole Type 1 SPD

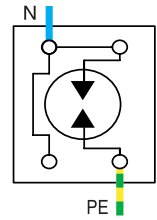
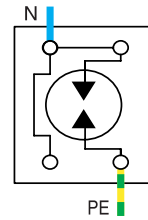
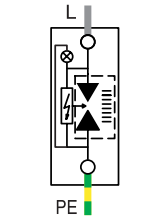
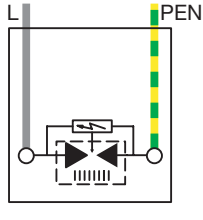
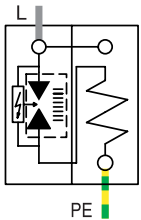

Multipole Type 1 SPD

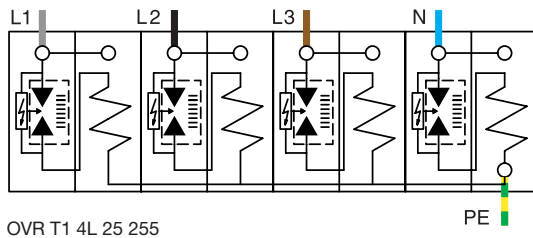
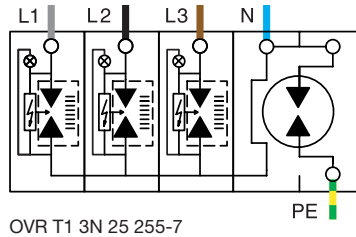
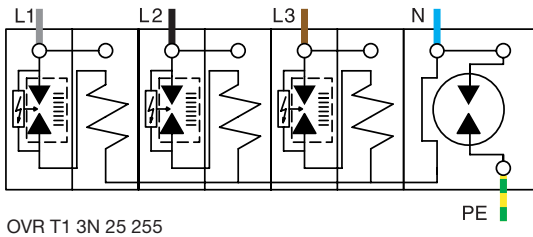
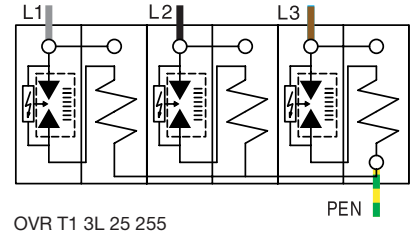
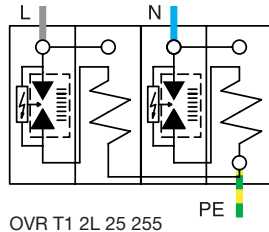
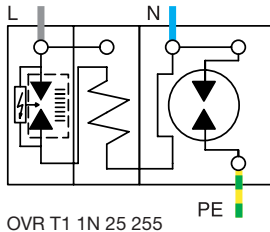

Multipole Type 1 SPD with remote indication (TS)

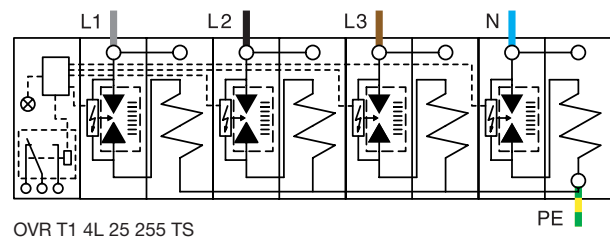
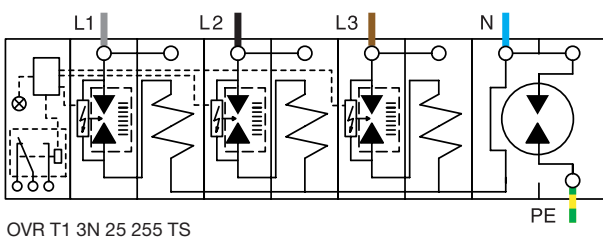
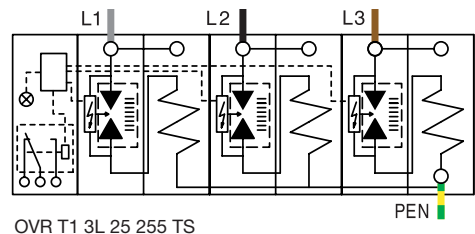
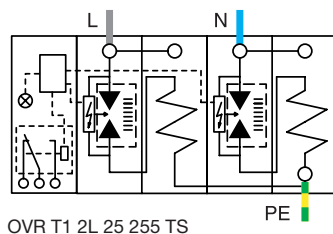
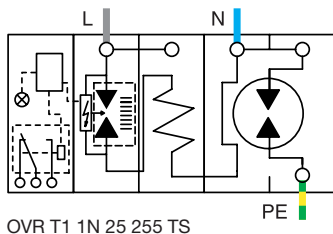

Photovoltaic SPDs - OVR PV

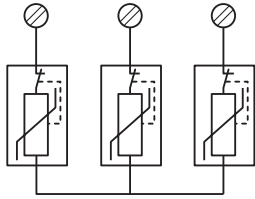

OVR PV 1000 V

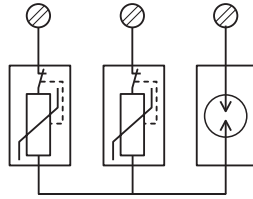

OVR PV 600 V

2CSC400468F0202

Low Current SPDs - OVR TC

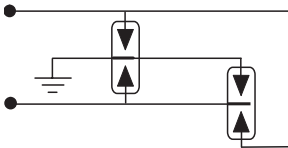

OVR TC 200 V in parallel

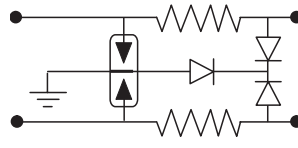

OVR TC / xx V / 200 FR in series

2CSC400469F0202

Type 1+2 internal schematic

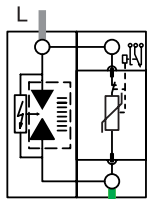

PE

OVR T1+2 25 255 TS

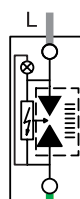

PE

OVR T1+2 15 255-7

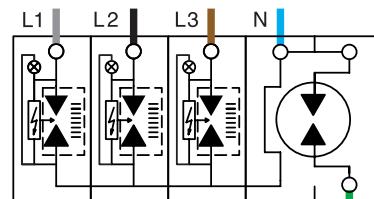

PE

OVR T1+2 3N 15 255-7

2CSC400470F0202

Type 1+2 / Type 2 internal schematic

Non pluggable Type 2 SPDs

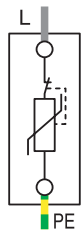

OVR T2 40 275
OVR T2 15 275

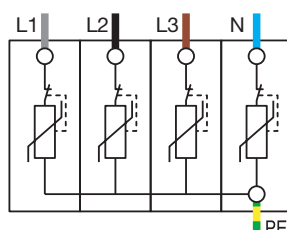

OVR T2 4L 40 275

2CSC400471F0202

Pluggable Type 1+2 / Type 2 SPDs

Single pole Type 2 SPD

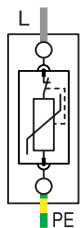

OVR T2 15 275 P
OVR T2 40 275 P
OVR T2 15 440 P
OVR T2 40 440 P

Single pole Type 2 SPD with safety reserve (s)

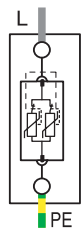

OVR T2 40 275s P
OVR T2 70 275s P
OVR T2 40 440s P
OVR T2 70 440s P
OVR T1+2 7 275s P

Single pole Type 2 SPD with remote indication (TS)

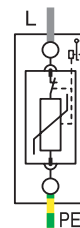

OVR T2 15 275 P TS
OVR T2 40 275 P TS
OVR T2 15 440 P TS
OVR T2 40 440 P TS

Single pole Type 2 SPD with safety reserve (s) and remote indication (TS)

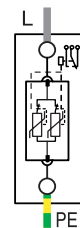

OVR T2 40 275s P TS
OVR T2 70 275s P TS
OVR T2 40 440s P TS
OVR T2 70 440s P TS

2CSC400472F0202

Multipole Type 2 SPD

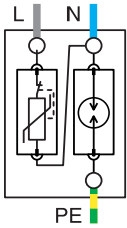

OVR T2 1N 15 275 P
OVR T2 1N 40 275 P

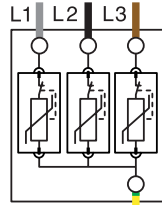

OVR T2 3L 15 275 P
OVR T2 3L 40 275 P

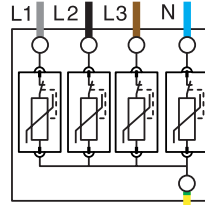

OVR T2 4L 15 275 P
OVR T2 4L 40 275 P

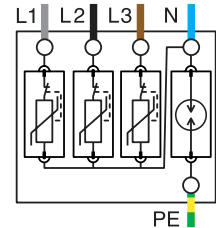

OVR T2 3N 15 275 P
OVR T2 3N 40 275 P

Multipole Type 2 SPD with safety reserve (s)

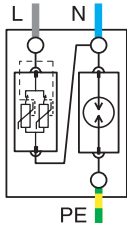

OVR T2 1N 40 275s P
OVR T2 1N 70 275s P
OVR T1+2 1N 7 275s P

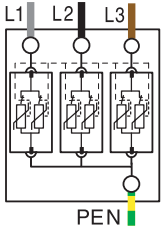

OVR T2 3L 40 275s P
OVR T2 3L 70 275s P
OVR T1+2 3L 7 275s P

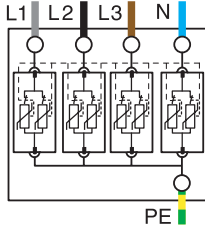

OVR T2 4L 40 275s P
OVR T2 4L 70 275s P
OVR T1+2 4L 7 275s P

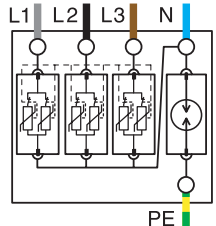

OVR T2 3N 40 275s P
OVR T2 3N 70 275s P
OVR T1+2 3N 7 275s P

Multipole Type 2 SPD with remote indication (TS)

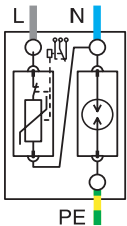

OVR T2 1N 15 275 P TS
OVR T2 1N 40 275 P TS

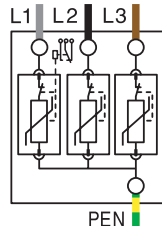

OVR T2 3L 15 275 P TS
OVR T2 3L 40 275 P TS

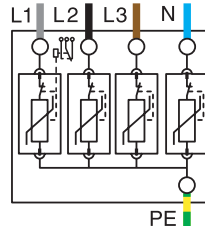

OVR T2 4L 15 275 P TS
OVR T2 4L 40 275 P TS

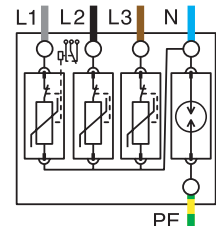

OVR T2 3N 15 275 P TS
OVR T2 3N 40 275 P TS

Multipole Type 2 SPD with safety reserve (s) and remote indication (TS)

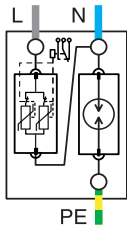

OVR T2 1N 40 275s P TS
OVR T2 1N 70 275s P TS

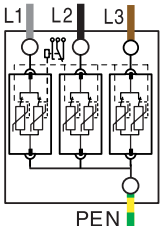

OVR T2 3L 40 275s P TS
OVR T2 3L 70 275s P TS

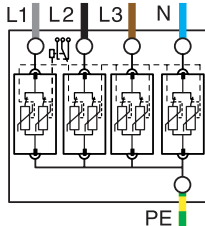

OVR T2 4L 40 275s P TS
OVR T2 4L 70 275s P TS

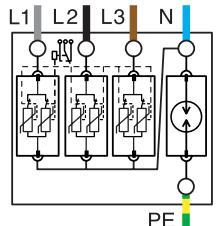

OVR T2 3N 40 275s P TS
OVR T2 3N 70 275s P TS

Type 2 auto-protected SPD

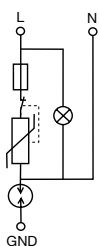

OVR Plus 1N 10

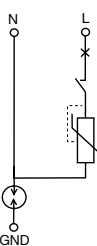

OVR Plus N1 40

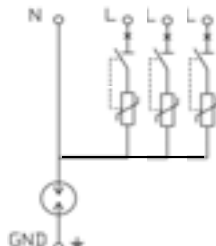

OVR Plus N3 15

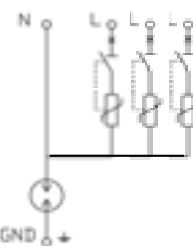

OVR Plus N3 40

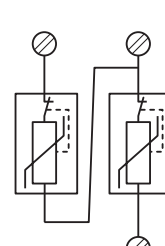

OVR 2 15 75



Type 2 Special 24/48 AC & DC - OVR 75 V

2CSC400473F0202

Installation rules for SPDs: choice of associated breaking devices (fuse/circuit-breaker)

Choice of disconnecter

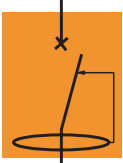
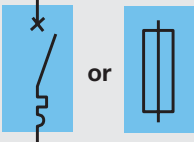
Surge arresters must be associated with upstream short-circuit protection and residual current protection against indirect contact (usually already present in the installation).

	Function	Application
	Protection against indirect contact	<ul style="list-style-type: none"> Residual current circuit-breaker compulsory for TT systems Residual current circuit-breaker possible for TN-S, IT and TN-C-S systems Residual current circuit-breaker forbidden for TN-C systems If a residual current circuit-breaker is used, it is preferable to use a type S. Otherwise there is a risk of nuisance tripping. This does not affect the effectiveness of the surge arrester, but may cause the circuit to be opened.
	Protection against fault currents	The breaking device associated with the surge arrester can be either a circuit breaker or a fuse. Its rating should take into consideration the surge arrester's characteristics and the short-circuit current of the installation.
	Thermal protection	Thermal protection is integrated into the surge arrester.

Maximum circuit breaker or fuse protection rating depending on I_{max} or I_{imp} of surge arrester and perspective (I_p) short circuit current at SPD location.



Type 1 surge arresters OVR T1 / OVR T1+2	Circuit breaker (Curve C)	Fuse (gG)
$I_{imp}(10/350)$: 25 kA • $I_p = 0.3$ kA to I_{scw}		≤ 125 A
Type 1+2 surge arresters OVR T1+2		
$I_{imp}(10/350)$: 15 kA • $I_p = 0.3$ kA to I_{scw}		≤ 125 A
$I_{imp}(10/350)$: 7 kA • $I_p = 0.3$ kA to 2 kA	≤ 25 A	≤ 16 A
• $I_p = 2$ kA to 6 kA	≤ 32 A	≤ 25 A
• $I_p = 6$ kA to I_{scw}	≤ 50 A	≤ 50 A
Type 2 surge arresters OVR T2 pluggable or T2 & T3 non pluggable		
$I_{max}(8/20)$: 10 kA, 15 kA, 40 kA, 70 kA or 120 kA • $I_p = 0.3$ kA to 2 kA	≤ 25 A	≤ 16 A
• $I_p = 2$ kA to 6 kA	≤ 32 A	≤ 25 A
• $I_p = 6$ kA to I_{scw}	≤ 50 A	≤ 50 A
Type 2 surge arresters OVR T2 non pluggable		
$I_{max}(8/20)$: 15 kA or 40 kA • $I_p = 0.3$ kA to I_{scw}	≤ 63 A	≤ 125 A

Possible MCB's: Series S 941 N, SN 200, S 200 L, S 200 / S 200 M, and series S 200 P / S 500 / S 800.

I_p : perspective short circuit at SPD location.

I_{scw} : short-circuit withstand capacity.

Cabling and installation of Surge Protective Devices in an electrical panel

50 cm rule

Remember that a 10 kA lightning current passing through a 1 m length of cable generates 1000 Volts. Equipment protected by a surge arrester is subjected to a voltage equal to the sum of the U_p voltage of the surge arrester, U_d of its disconnector and the sum of the inductive voltages of connecting cables ($U_1+U_2+U_3$).

It is therefore essential that the total length ($L = L_1+L_2+L_3$) of the connecting cables is as short as possible (0.50 m).

If this length ($L = L_1 + L_2+L_3$) exceeds 0.50m, it is necessary to carry out one of the following:

- Reduce this length by moving the connection terminals.
- Choose a surge arrester with a lower U_p value.
- Install a second, coordinated surge arrester near the device to be protected so as to adapt the combined U_p value to the impulse withstand of the equipment to be protected.

Wiring ring surfaces

The wires must be arranged in such a way that they are as close to each other as possible (see adjacent diagram) to avoid overvoltages induced by a ring surface between phases, the neutral and the PE conductor.

Routing of clean cables and polluted cables

During installation, lay clean cables (protected) and polluted cables as shown in the adjacent diagrams.

To avoid magnetic coupling between the different cable types (clean and polluted), it is strongly advised that they are kept apart (> 30 cm) and if a crossing cannot be avoided, it should be at right angles (90°).

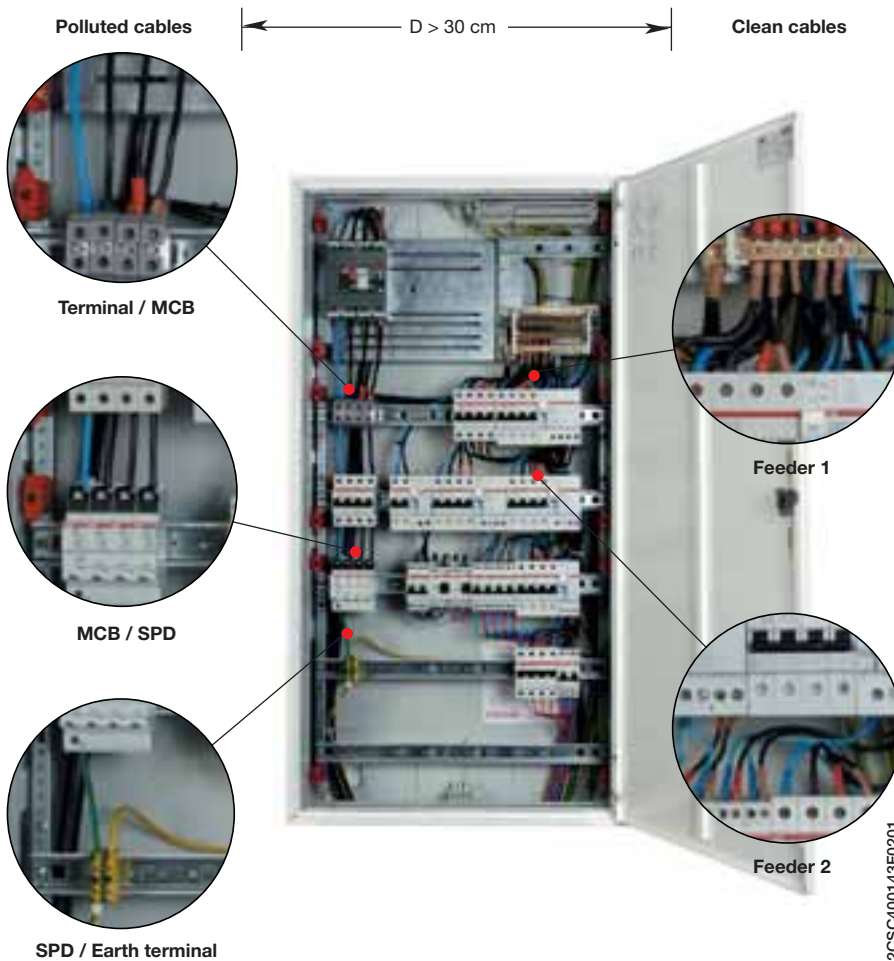
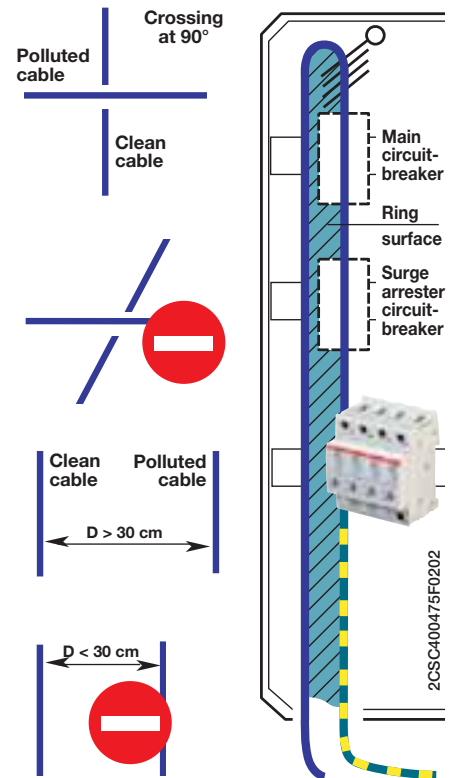
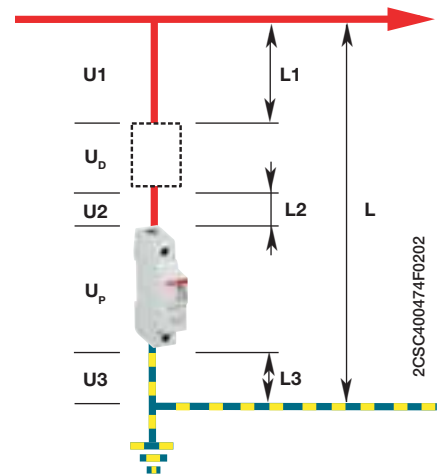

Note

The cross-section of the connecting cables is calculated according to the local short-circuit current level (where the surge arrester is installed). It must be equal to the cross-section of the installation's upstream cables.

The minimum cross-section for the earth conductor is 4 mm² if there is not a lightning conductor and 10 mm² if there is a lightning conductor.

Equipotential grounding:

It is critical to check the earth equipotentiality of the various items of equipment.



E 90 FUSE-HOLDERS

IEC 60947-3: Switches, disconnectors, switch-disconnectors and fuse combination units

This standard sets out the requirements of devices for connect/disconnect and switching operations.

Disconnecter:

The disconnector is a mechanical device that, in the open position, meets the requirements specified for the disconnect function by the international IEC 60947-3 standard. The opening of a disconnector guarantees that the downstream circuit is electrically isolated from the upstream circuit. This is a required condition before personnel can access the equipment on the network, for example to perform maintenance. The IEC 60364 standard prohibits carrying out maintenance on the installation if the circuits have not been disconnected.

Fuse disconnector:

This is the definition of a fuse carrier that performs a disconnect function. Not all fuse carriers are disconnectors: in order to be classified as such they must meet the requirements and pass the tests prescribed by the IEC 60947-3 standard.

Fuse switch-disconnector:

This is the designation given by the IEC 60947-3 standard to a fuse disconnector that permits switching under load. Not all fuse disconnectors allow this type of operation: in order to be classified as a fuse switch-disconnector, a device must have utilization category AC-21B or higher.

Utilization categories:

Not all connect/disconnect devices have the same performance specifications: the permitted operations depend on a parameter which defines the specific conditions of use, called the utilization category.

It specifies:

- a. The type of network (a.c./d.c.)
- b. The permitted type of operation (under no load, for resistive loads, for highly inductive loads, ecc...)
- c. The frequency of use

The E90 fuse switch-disconnectors have utilization category AC-22B. The E 90 PV fuse disconnectors have utilization category DC-20B.

Type of current	Utilization category		Typical applications
	A	B	
Alternating current	AC-20A	AC-20B	Connecting and disconnecting under no load.
	AC-21A	AC-21B	Switching of resistive loads, including moderate overloads
	AC-22A	AC-22B	Switching of mixed, resistive and inductive loads, including moderate overloads
	AC-23A	AC-23B	Switching of motors or other highly inductive loads
Direct current	DC-20A	DC-20B	Connecting and disconnecting under no load.
	DC-21A	DC-21B	Switching of resistive loads including moderate overloads
	DC-22A	DC-22B	Switching of mixed, resistive and inductive loads, including moderate overloads (e.g. shunt motors)
	DC-23A	DC-23B	Switching of highly inductive loads (e.g. series connected motors)

What loads can be connected/disconnected by a product with utilization category AC-22B?

Utilization category AC-22B permits occasional switching of mixed, resistive and inductive loads, including moderate overloads, in alternating current circuits. Examples of mixed loads are: transformers, power-factor corrected motors, capacitor banks, discharge lamps, heating, etc..

What loads can be connected/disconnected by a product with utilization category AC-20B?

Utilization category AC-20B does not permit connecting or disconnecting under load. An additional load break device is required.

IEC 60269-1: Fuses with voltage rating not exceeding 1000 V for alternating current and 1500 V for direct current

This standard sets out the requirements for low voltage fuses, and consequently the requirements for the fuse carrier devices that hold them.

The standard has two separate sections with different requirements, depending on the type of person using the equipment.

IEC 60269-2: supplementary requirements for fuses for use by authorized persons, mainly for industrial applications.

IEC 60269-3: supplementary requirements for fuses for use by unskilled persons, mainly for household and similar applications.

What is the difference between a fuse carrier conforming to the IEC 60947-3 standard and one conforming to the IEC 60269-2 standard?

These are two complementary standards: IEC 60269-2 sets out the characteristics of the fuses, which in turn also determine the general requirements for the fuse carriers. It is therefore the reference standard for overcurrent protection, but not for connecting/disconnecting and switching.

Is a fuse carrier conforming to IEC 60269-1 a disconnecter?

A device conforming only to IEC 60269 has a "disconnect function" but is not classified as a disconnecter under the more stringent IEC 60947-3 standard.

Why does the E 90 series have a lower direct current voltage rating under the IEC 60269-3 standard than under the IEC 60269-2 standard?

IEC 60269-2 sets out the requirements for industrial applications, and therefore the reference voltages are higher than those for the residential and commercial applications covered by IEC 60269-3. In other words, the rated voltage of the fuse carrier depends on the type of installation in which it is used, and the regulations applicable to it.

Is it possible to create multi-pole configurations using an assembly kit?

Multi-pole units made up using an assembly kit to combine single pole units will no longer conform to the reference standards.

In case of installations with many poles side by side, or installations in particular climate conditions, what derating of the nominal values should be taken into account?

The following tables give the parameters for derating the nominal current as a function of the number of poles installed side by side or the temperature and relative humidity.

Installation of multiple poles side by side:

E 91/32		E 91hN/32	
Poles	Maximum current	Poles	Maximum current
1 ...4	I_n	1 ...3	I_n
5...7	$0.8 \times I_n$	4...9	$0.7 \times I_n$
more than 7	$0.7 \times I_n$	more than 10	$0.6 \times I_n$

Climate conditions:

Maximum temperature	20 °C	30 °C	40 °C	50 °C
Maximum humidity	95 %	90 %	80 %	50 %
Maximum current	I_n	$I_n \times 0.95$	$I_n \times 0.9$	$I_n \times 0.8$



E 930 FUSE-HOLDERS

Power consumption in Watt at rated current

Fuse rating In [A]	Fuses 14x51 gG	Fuses 22x58 gG
50	5.00	5.50
63		6.35
80		7.35
100		8.75
125		12.50

Power consumption in Watt at rated current

Fuse rating In [A]	Fuses 14x51 aM	Fuses 22x58 aM
50	2.50	3.00
63		4.10
80		5.20
100		6.50
125		7.80

EPD 24

Time/Current characteristic curve (T_U = 25 °C)

- The trip time is typically 3 s in the range between 1.1 and 1.8 x I_N¹⁾.
- Electronic current limitation occurs at typically 1.8 x I_N¹⁾ which means that under all overload conditions (independent of the power supply and the resistance of the load circuit) the max. overload before disconnection will not exceed 1.8 x I_N¹⁾ times the current rating. Trip time is between 100 ms and 3 sec (depending on overload or at short circuit).
- Without this current limitation a considerably higher overload current would flow in the event of an overload or short circuit.

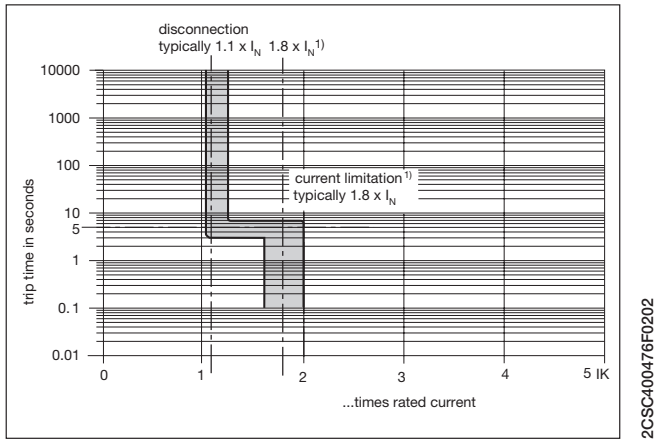

¹⁾ Current limitation typically 1.8 x I_N at I_N = 0.5 A...6 A
Current limitation typically 1.5 x I_N at I_N = 8 A or 10 A
Current limitation typically 1.3 x I_N at I_N = 12 A

Maximum cable lengths

EPD24 reliably trips from 0 Ω up to max. circuit resistance R_{max}'

Calculation of R_{max}

Selected rating I _N (A)	3	6
Operating voltage U _S (V DC) (= 80 % of 24 V) ²⁾	19.2	19.2
Trip current I _{ab} = 1.25 x I _N (A) (EPD24 trips after 3 s)	3.75	7.50
R_{max} (Ω) = (U_B/I_{ab}) - 0.050	5.07	2.51

²⁾ Voltage drop of EPD24 and tolerance of trip point (typically 1.1 x I_N = 1.05 ... 1.35 x I_N) have been taken into account

Selection table for the incoming cable lengths with different cable cross-sections

Cable cross section A (mm ²)	0.14	0.25	0.34	0.5	0.75	1.00	1.50
Cable length L (m) (= single length)	cable resistance (Ω) = (ρ₀ x 2 x L) / A³⁾						
5	1.27	0.71	0.52	0.36	0.24	0.18	0.12
10	2.54	1.42	1.05	0.71	0.47	0.36	0.24
15	3.81	2.14	1.57	1.07	0.71	0.53	0.36
20	5.09	2.85	2.09	1.42	0.95	0.71	0.47
25	6.36	3.56	2.62	1.78	1.19	0.89	0.59
30	7.63	4.27	3.14	2.14	1.42	1.07	0.71
35	8.90	4.98	3.66	2.49	1.66	1.25	0.83
40	10.17	5.70	4.19	2.85	1.90	1.42	0.95
45	11.44	6.41	4.71	3.20	2.14	1.60	1.07
50	12.71	7.12	5.24	3.56	2.37	1.78	1.19
75	19.07	10.68	7.85	5.34	3.56	2.67	1.78
100	25.34	14.24	10.47	7.12	4.75	3.56	2.37
125	31.79	17.80	13.09	8.90	5.93	4.45	2.97
150	38.14	21.36	15.71	10.68	7.12	5.34	3.56
175	44.50	24.92	18.32	12.46	8.31	6.23	4.15
200	50.86	28.48	20.94	14.24	9.49	7.12	4.75
225	57.21	32.04	23.56	16.02	10.68	8.01	5.34
250	63.57	35.60	26.18	17.80	11.87	8.90	5.93

³⁾ Resistivity of copper ρ₀ = 0.0178 (Ω x mm²)/m

Example 1: max. length for 1.5 mm² and 3 A: **214 m**

Example 2: max. length for 1.5 mm² and 6 A: **106 m**

Example 3: mixed wiring: (Control cabinet --- sensor/actuator level)

R1 = 40 m for 1.5 mm² and R2 = 5 m for 0.25 mm²:

R1 = 0.95 Ω, R2 = 0.71 Ω, **total (R1 + R2) = 1.66 Ω**

Please note

The user should ensure that the cable cross sections of the relevant load circuit are suitable for the current rating of the EPD24 used. Automatic start-up of machinery after shut down must be prevented (Machinery Directive 98/37/EG and EN 60204-1). In the event of a short circuit or overload the load circuit will be disconnected electronically by the EPD24.

Information on UL approvals/CSA approvals



Operating Temperature Code T5

- This equipment is suitable for use in Class I, Division 2, Groups A, B, C and D or non-hazardous locations only

WARNING:

- Exposure to some chemicals may degrade the sealing properties of materials used in the following device: relay
Sealant Material:

Generic Name: Modified diglycidyl ether of bisphenol A
Supplier: Fine Polymers Corporation
Type: Epi Fine 4616L-160PK

Casing Material:

Generic Name: Liquid Crystal Polymer
Supplier: Sumitomo Chemical
Type: E4008, E4009, or E6008

RECOMMENDATION:

- Periodically inspect the device named above for any degradation of properties and replace if degradation is found

WARNING – EXPLOSION HAZARD:

- Do not disconnect equipment unless power has been removed or the area is known to be non-hazardous
- Substitution of any components may impair suitability for Class I, Division 2

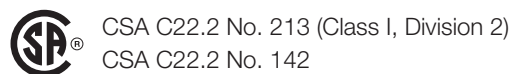
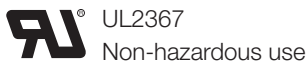

Class 2

Meets requirement for Class 2 current limitation (EPD24 ... -0,5 A/1 A/2 A/3 A)

The EPD24 features an integral power distribution system.

The following wiring modes are possible with various pluggable current and signal busbars:

- LINE+ (24 V DC)
- 0 V
- Caution:** The electronic devices EPD24 require a 0 V connection
- Auxiliary contacts

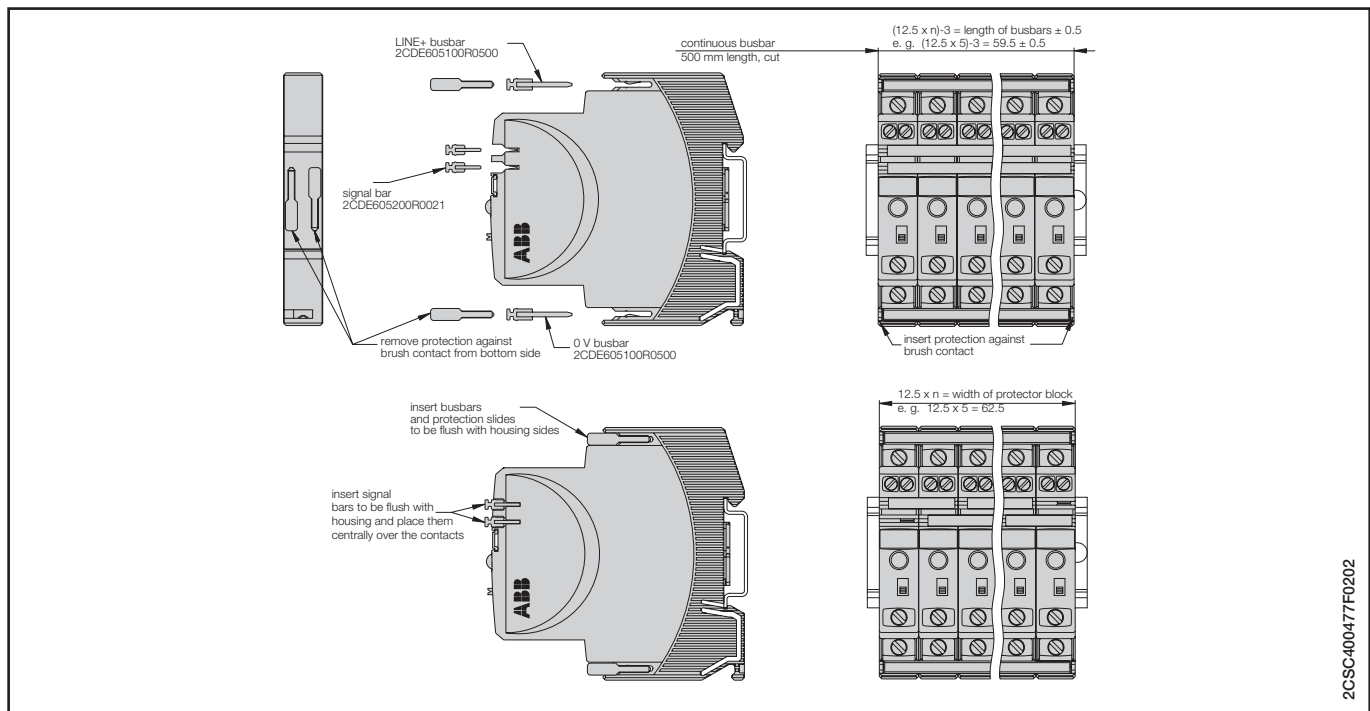

Mounting procedure

Before wiring insert busbars into protector block. A maximum of 10 connection cycles are permissible using connecting busbars.

Recommendation

After 10 units the busbars should be interrupted and receive a new entry live.

Table of length for busbars

(Order code 2CDE605100R0500)

No. of units	2	3	4	5	6	7	8	9	10
Length of busbar (mm) ± 0.5 mm	22	34.5	47	59.5	72	84.5	97	109.5	122

INSULATION MONITORING DEVICES

Wiring diagrams

The following schemes illustrate the ISOLTESTER-DIG-RZ and ISOLTESTER-DIG-PLUS wiring diagrams with the QSD-DIG 230/24 remote signalling panel in single- and three-phase networks, with or without central socket, and the SELVTESTER-24 wiring diagrams with QSD-DIG 230/24 remote signalling panel.

Wiring diagram with transformer with central socket (PC)

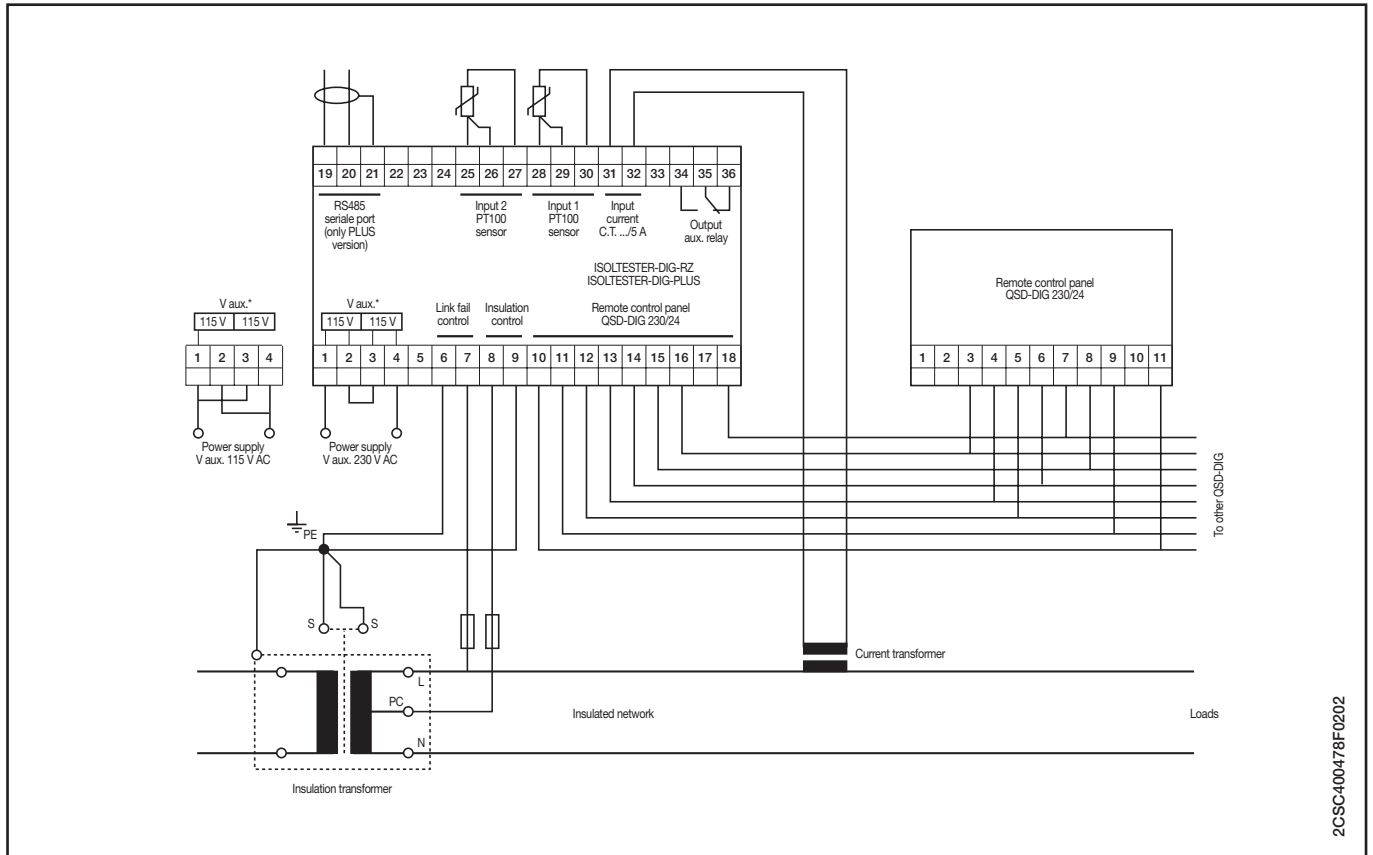

Wiring diagram with transformer without central socket (PC)

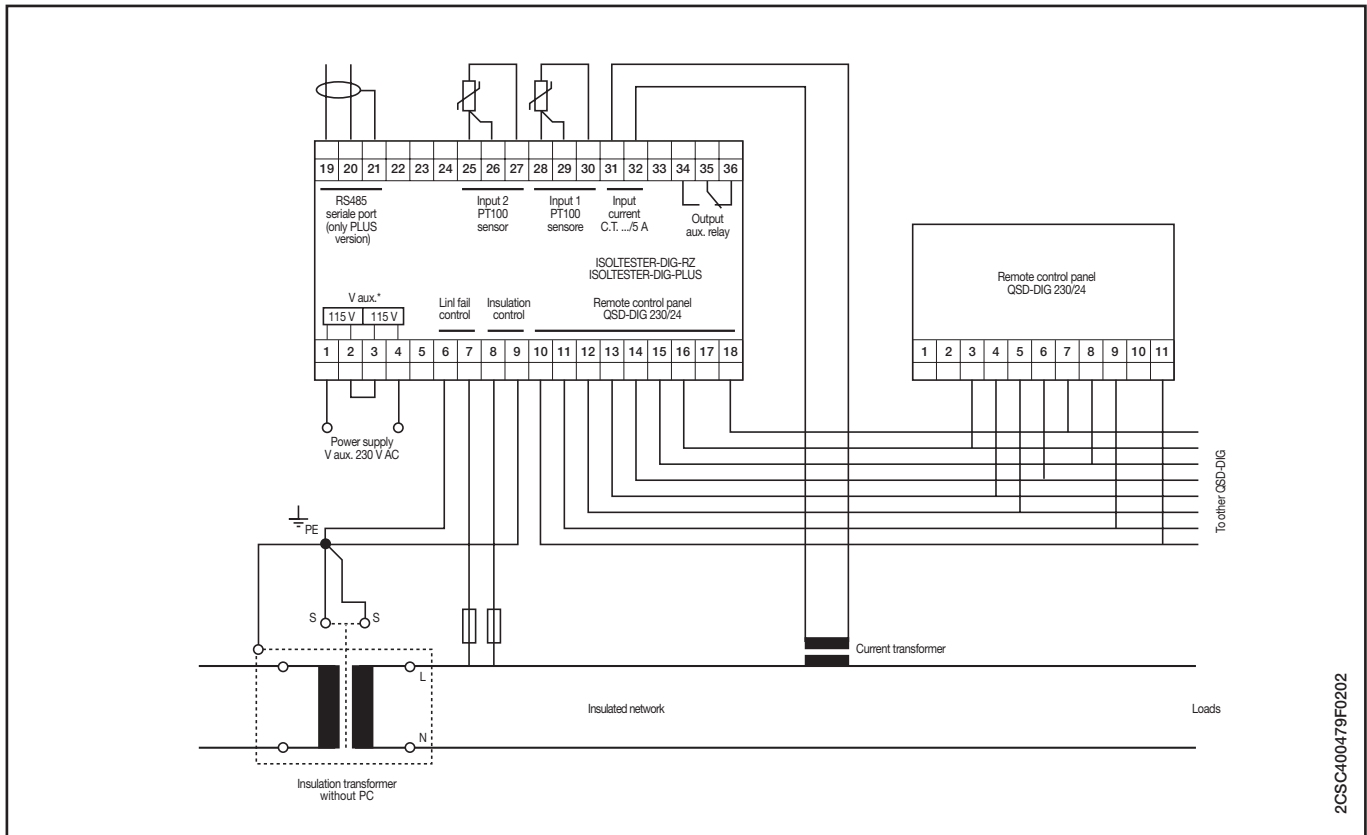

Wiring diagram with three-phase transformer

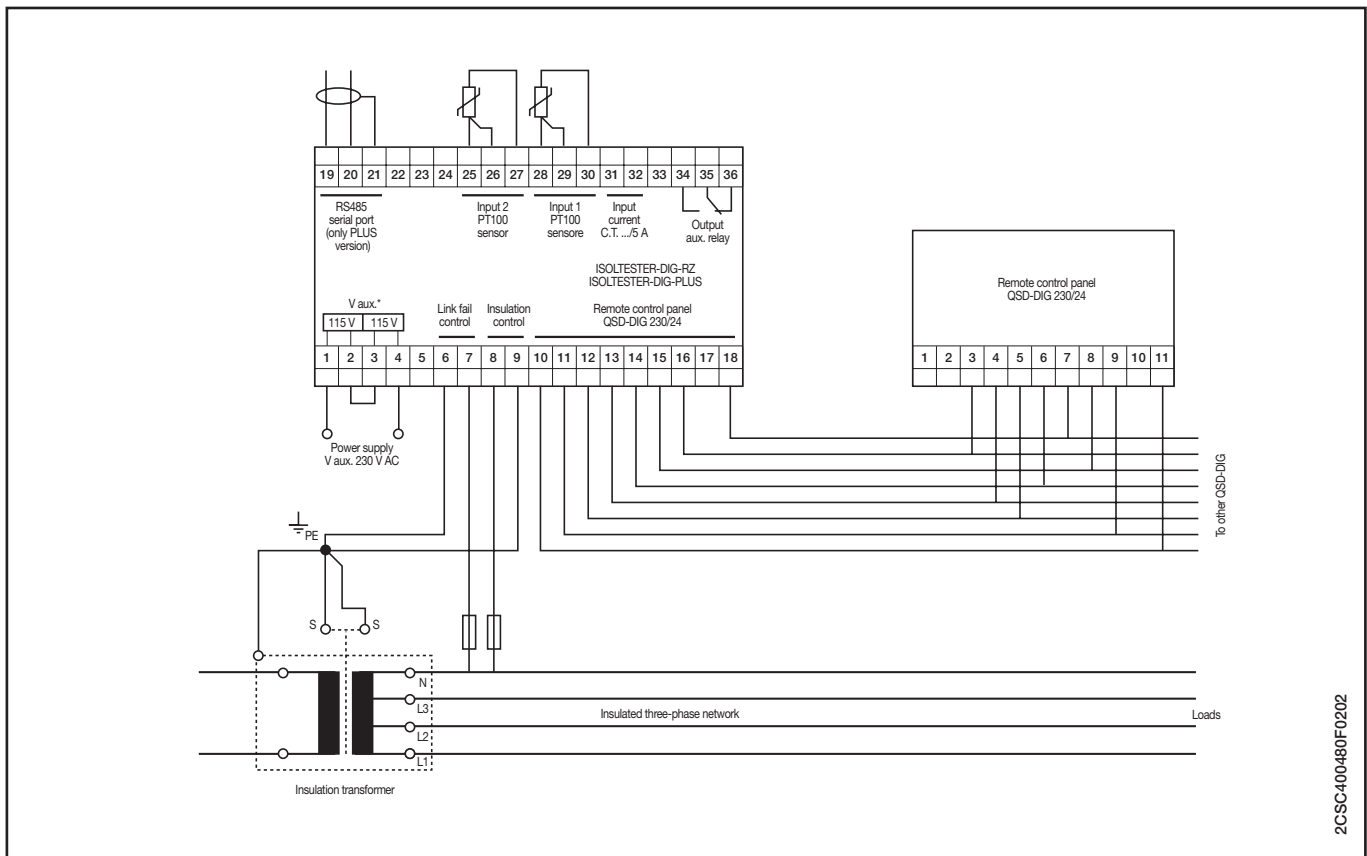

11

SELVTESTER-24

Wiring diagram with transformer 220/24

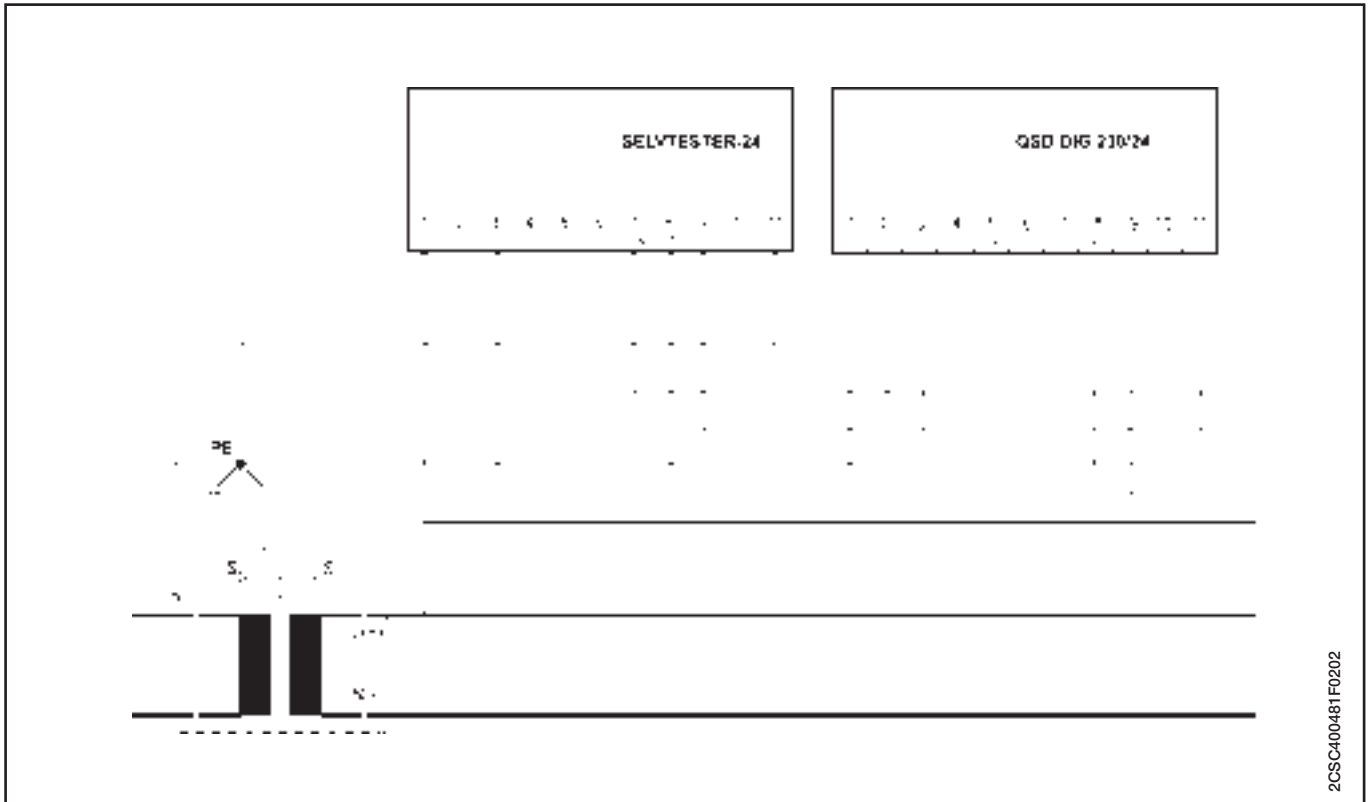

2CSC400481F0202

QSD-DIG 230/24

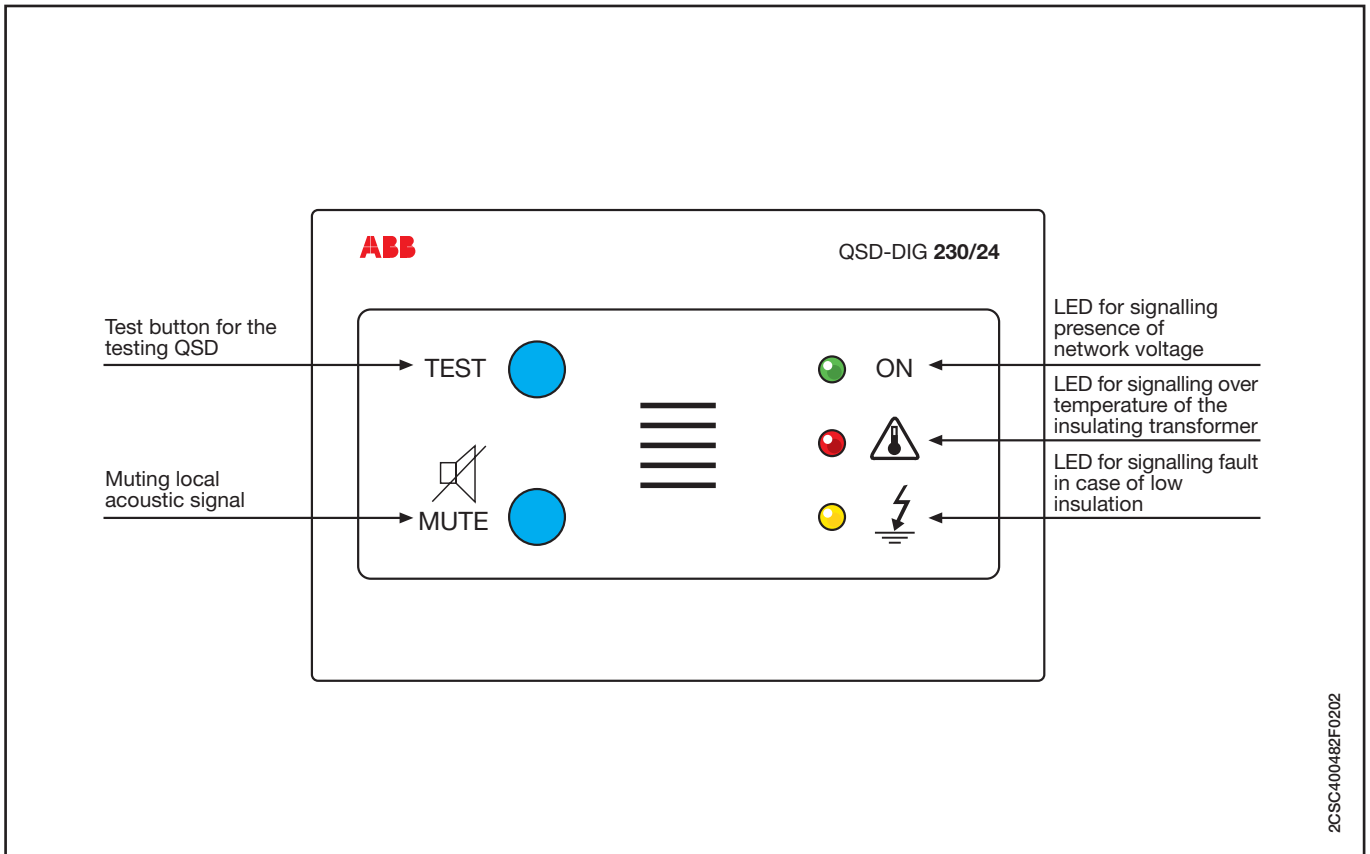

2CSC400482F0202

INSULATION MONITORING DEVICES ISL FOR INDUSTRIAL APPLICATIONS

ISL-A 24-48

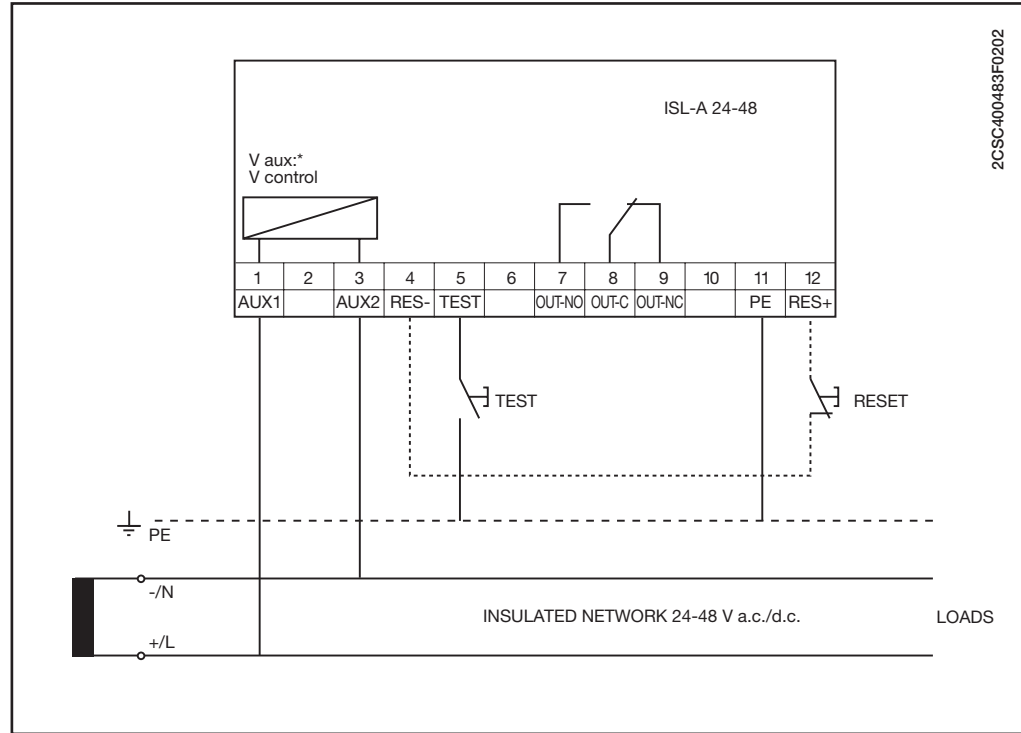

MICROSWITCH SETTINGS

The front microswitches allow the insulation threshold level to be adjusted between 10 and 60 kΩ, as shown below:

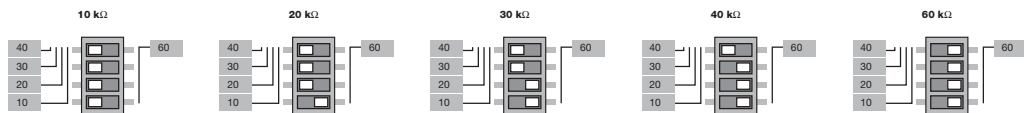

ISL-A 115 and ISL-A 230

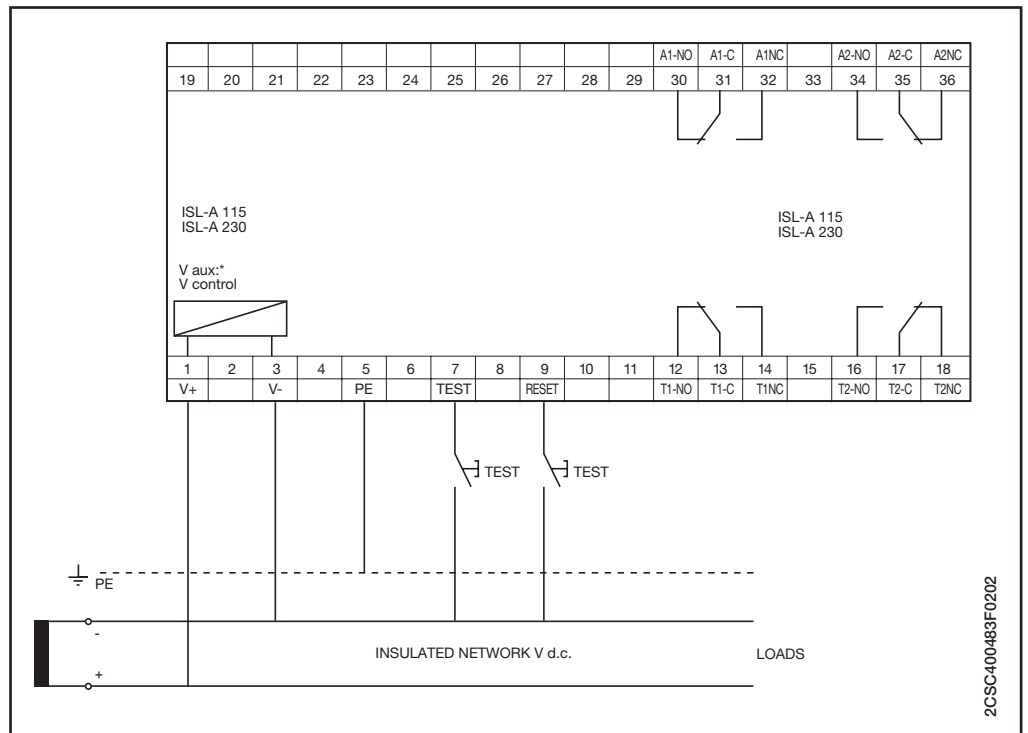

MICROSWITCH SETTINGS

The front microswitches are used for adjusting the insulation threshold level, enabling the fail-safe function and configuring the reset mode for both the alarm and trip thresholds.

Microswitches A, B, C, D for programming the trip and alarm thresholds:

ALARM				TRIP			
300 kΩ:	A=0,	B=0,	D=0	100 kΩ:	A=0,	B=0,	D=0
150 kΩ:	A=1,	B=0,	D=0	60 kΩ:	A=1,	B=0,	D=0
80 kΩ:	A=1,	B=1,	D=0	40 kΩ:	A=1,	B=1,	D=0
50 kΩ:	A=1,	B=1,	D=0	20 kΩ:	A=1,	B=1,	D=0
30 kΩ:	A=1,	B=1,	D=1	10 kΩ:	A=1,	B=1,	D=1

Microswitch E for configuring the FAIL SAFE mode

E=0 fail safe mode disabled
E=1 fail safe mode enabled

Microswitch F for configuring the RESET mode

F=0 manual reset
F=1 automatic reset

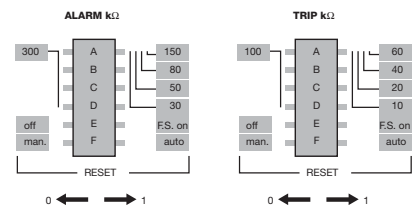

ISL-A 600

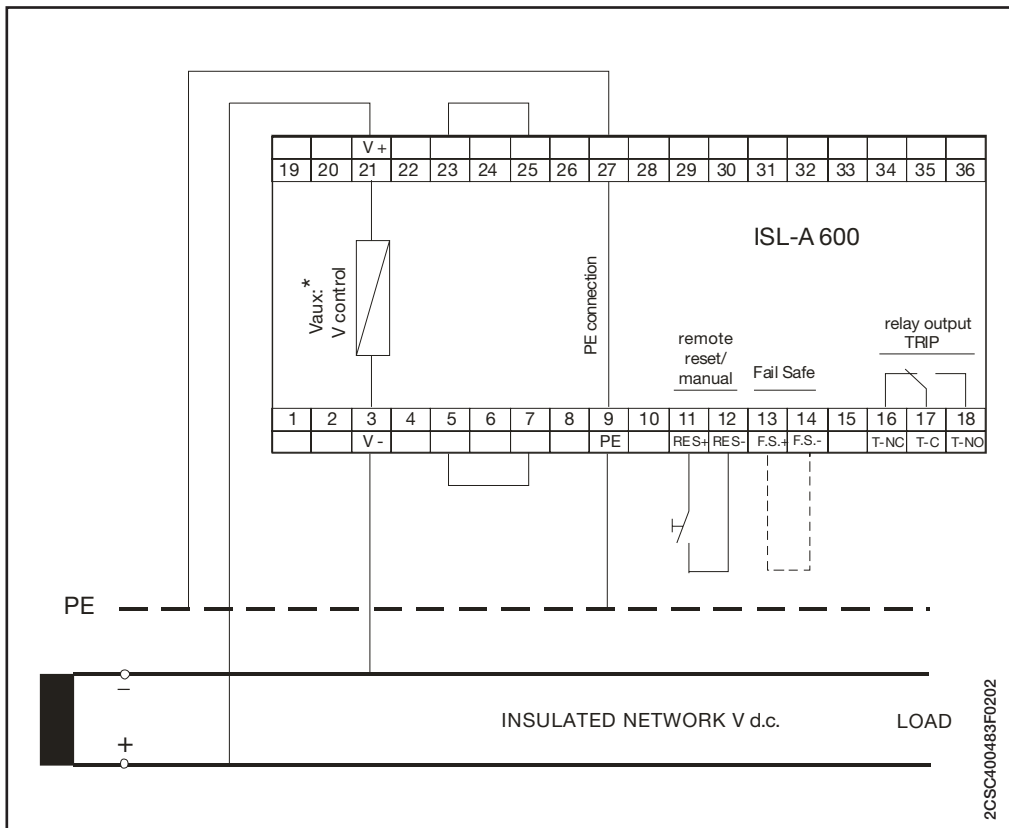

ISL-C 230

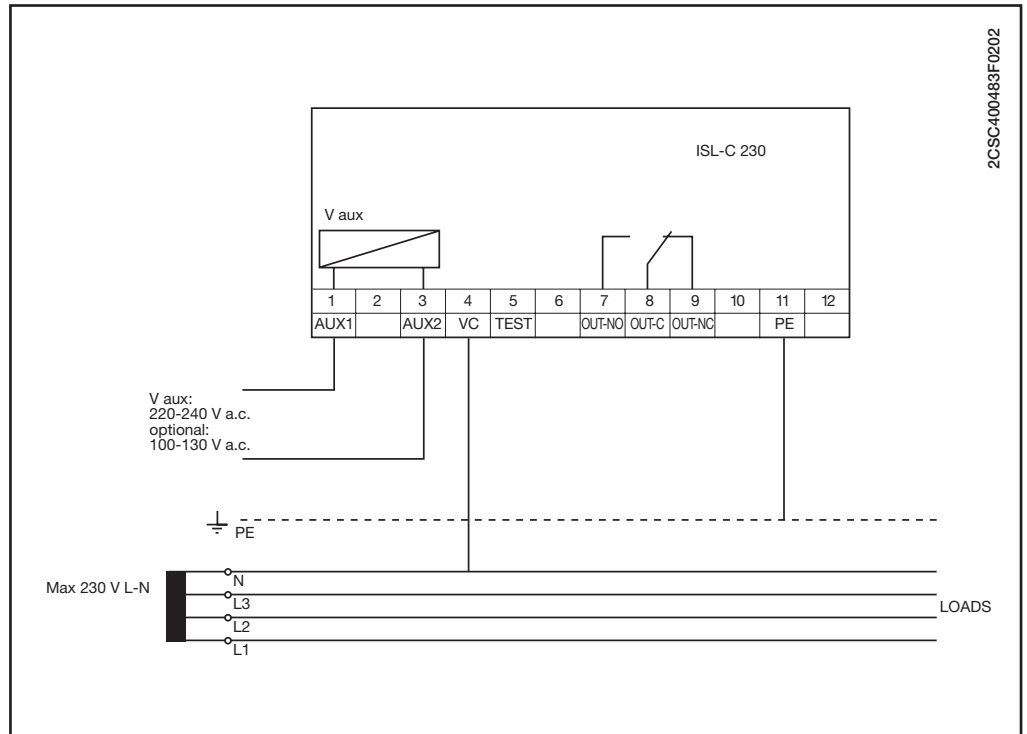

ISL-C 440

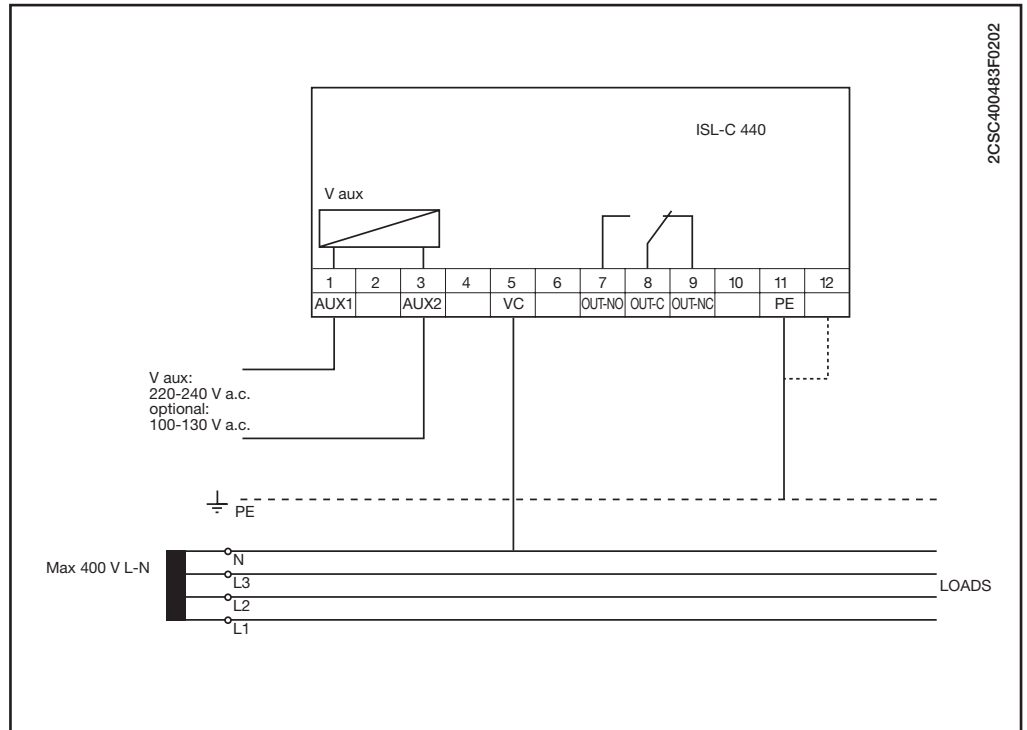

MICROSWITCH SETTINGS

The front microswitches are used for adjusting the insulation threshold level between 10 and 150 kΩ, as shown below:

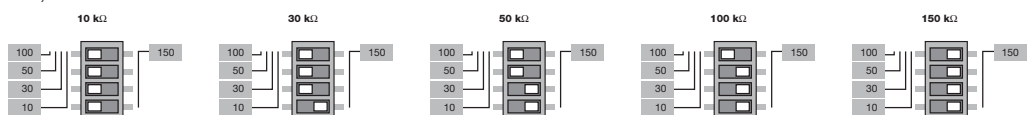

ISL-C 600

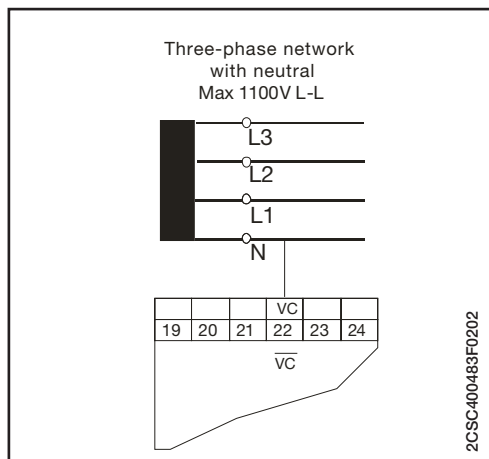
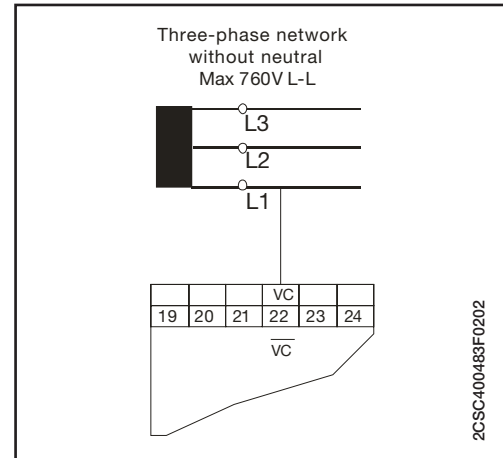
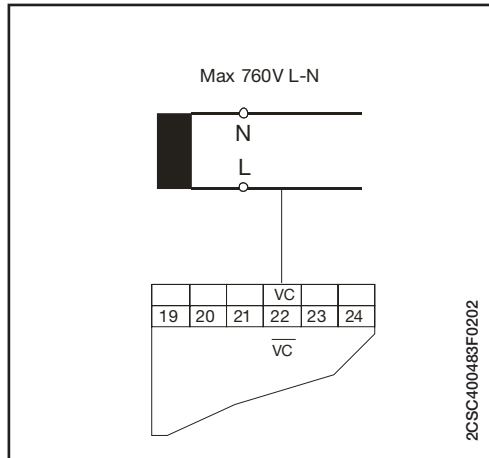
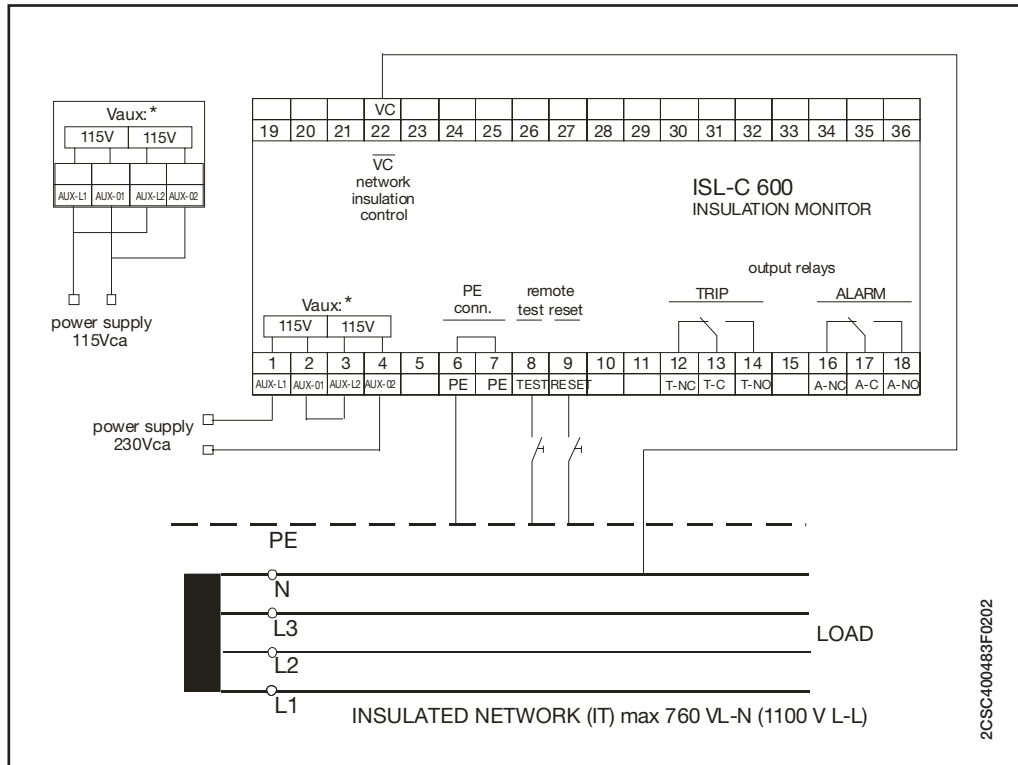

ISL-MOT 1000

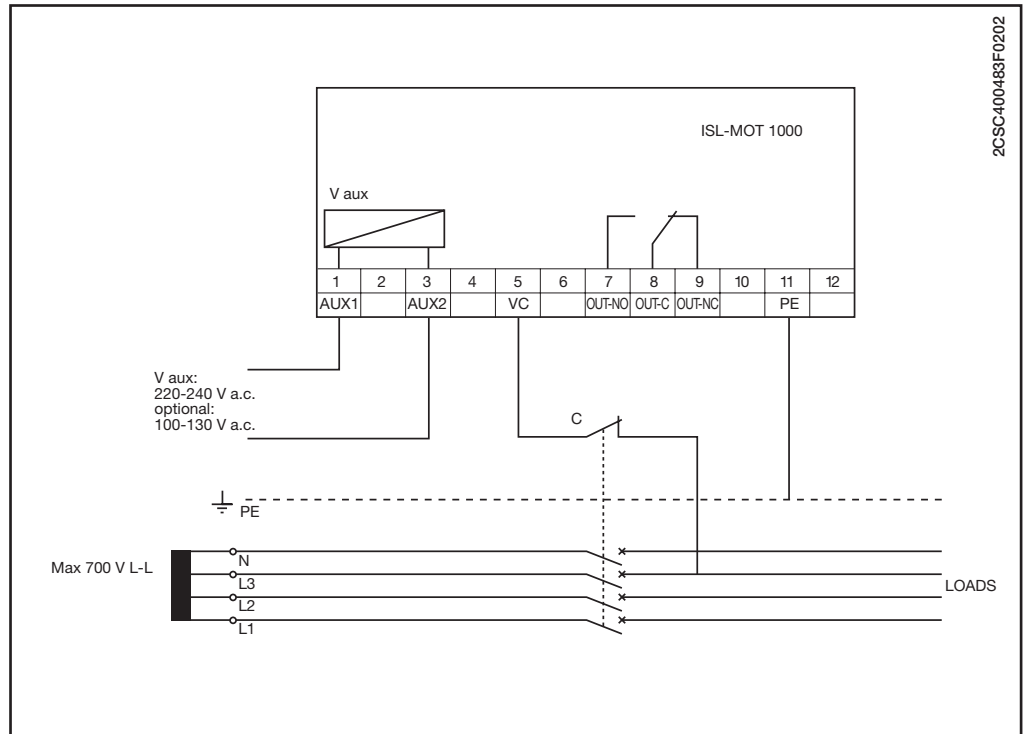

MICROSWITCH SETTINGS

The front microswitches are used for adjusting the insulation threshold level between 0.1 and 10 MΩ. A total of 7 microswitches are used, divided into two groups as shown below:

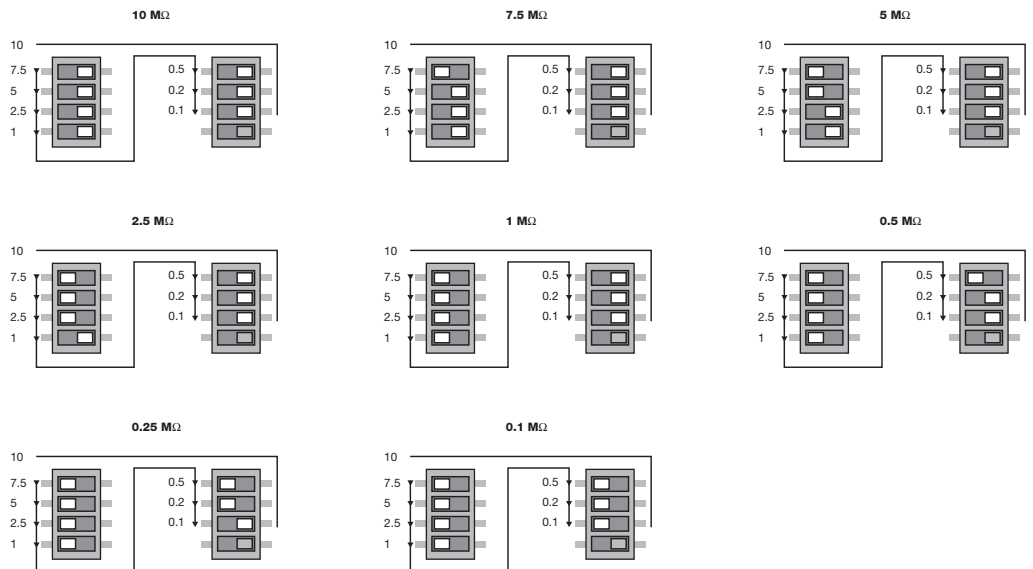



2CSC400759F0001

QSO ELECTRICAL PANEL FOR OPERATING THEATRES

Logical Operating Diagrams

Wall-mounted QSO switchboards

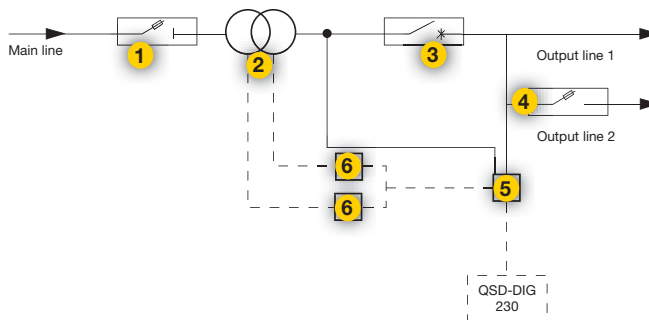

Description	3 kVA	5 kVA	7,5 kVA
1 Fuse holder E 930/50	25 A gL	32 A gL	40 A gL
2 Insulating transformer	3 kVA	5 kVA	7,5 kVA
3 Miniature circuit breaker S202 L	16 A	25 A	40 A
4 Fuse holder E 91N/32	2 A gL	2 A gL	2 A gL
5 ISOLTESTER-DIG-RZ	yes		
6 Temperature probe PT100	S version	S version	S version

2CSC400484F0202

Logical Operating Diagrams

Floor-standing QSO switchboards

Description	3 kVA	5 kVA	7,5 kVA	10 kVA
1 Disconnector, E202 100 A	100 A			
2 Miniature circuit breaker, S202 25 A - curve C	25 A - curve C			
3 Surge protection device, OVR T2 1N 40 275s P 40 kA - 275 V	40 kA - 275 V			
4 Miniature circuit breaker, S202 L 16 A - curve C	16 A - curve C			
5 RCBO circuit breaker, DS202 25 A 30 mA Type AC- Curve C	25 A 30 mA			
6 Miniature circuit breaker S202 20 A - curve D 32 - Curve D 50 - curve 2D 63 - curve D	20 A - curve D	32 - Curve D	50 - curve D	63 - curve D
7 Insulating transformer IT ...(S) 3 kVA 5 kVA 7.5 kVA 10 kVA	3 kVA	5 kVA	7,5 kVA	10 kVA
8 Fuse holder, E 932/50	50 A gL			
9 Fuse holder, E 90/32	2 A gL	2 A gL	2 A gL	2 GL
10 ISOLTESTER-DIG-RZ	yes			
11 Temperature probe, PT100	yes			
12 Transformer, 220/24 1 kVA, 24 V version	version 24 V			
13 SELVTESTER-24	version 24 V			
14 Miniature circuit breaker, S202 16 A - curve C	16 A - curve C			

E 259 INSTALLATION RELAYS

Information about lamp insertion between phase and neutral

	Power [W]	Number of switchable lamps
Incandescent lamps (230 V a.c.)		
	15	120
	25	72
	40	45
	60	30
	75	24
	100	18
	150	12
	200	9
	300	6
500	3	

	Power [W]	Number of switchable lamps
Fluorescent lamps without power factor capacitors		
	18	50
	36	25
	40	23
	58	16
	65	13

	Power [W]	Number of switchable lamps
Fluorescent lamps with power factor capacitors		
	18	17
	36	13
	40	12
	58	8
	65	7

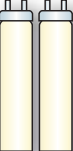
	Power [W]	Number of switchable lamps
Fluorescent twin-lamps		
	2 x 18	50
	2 x 36	25
	2 x 40	23
	2 x 58	16
	2 x 65	13

	Power [W]	Number of switchable lamps
Lamps with electronic reactor		
	1 x 18	38
	1 x 36	30
	1 x 58	17
	2 x 18	19
	2 x 36	15
	2 x 58	8

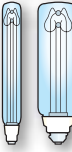
	Power [W]	Number of switchable lamps
Low pressure sodium vapor lamps (SOX)		
	55	6
	90	4
	135	3
	180	2
	185	2

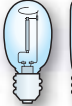
	Power [W]	Number of switchable lamps
High pressure sodium vapor lamps (NAV)		
	70	10
	150	5
	250	3
	400	2
	1000	-

	Power [W]	Number of switchable lamps
Metal halide and high pressure mercury vapor lamps (HQL)		
	50	16
	80	10
	125	7
	250	3
	400	2
	1000	-

	Power [W]	Number of switchable lamps
230 V halogen lamps (HQL)		
	150	12
	250	7
	300	6
	400	4
	500	3
	1000	2

	Power [W]	Number of switchable lamps
Very low voltage halogen lamps (12 or 24 V AC)		
	20	72
	50	29
	75	20
	100	15
	150	10
	200	7
300	5	

E 250 LATCHING RELAYS

Information about lamp insertion between phase and neutral

	Power [W]	Number of switchable lamps	
		E 250 - 16 A	E 250 - 32 A
Incandescent lamps (230 V a.c.)			
	15	200	266
	25	120	160
	40	75	102
	60	50	65
	75	40	52
	100	30	40
	150	20	26
	200	15	20
	300	9	12
	500	5	7

	Power [W]	Number of switchable lamps	
		E 250 - 16 A	E 250 - 32 A
Fluorescent lamps without power factor capacitors			
	18	81	110
	36	44	58
	40	38	53
	58	29	35
	65	26	34

	Power [W]	Number of switchable lamps	
		E 250 - 16 A	E 250 - 32 A
Fluorescent lamps with power factor capacitors			
	18	103	132
	36	63	81
	40	40	77
	58	41	52
	65	37	48

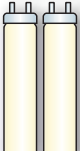
	Power [W]	Number of switchable lamps	
		E 250 - 16 A	E 250 - 32 A
Fluorescent twin-lamps			
	2 x 18	82	110
	2 x 36	41	55
	2 x 40	35	50
	2 x 58	23	30
	2 x 65	22	30

	Power [W]	Number of switchable lamps	
		E 250 - 16 A	E 250 - 32 A
Lamps with electronic reactor			
	18	83	112
	36	46	61
	58	31	38
	2 x 18	40	56
	2 x 36	23	30
	2 x 58	14	19

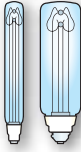
	Power [W]	Number of switchable lamps	
		E 250 - 16 A	E 250 - 32 A
Low pressure sodium vapor lamps (SOX)			
	55	27	36
	90	16	22
	135	11	14
	180	8	11
	185	8	10

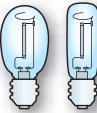
	Power [W]	Number of switchable lamps	
		E 250 - 16 A	E 250 - 32 A
High pressure sodium vapor lamps (NAV)			
	70	15	18
	150	8	10
	250	4	6
	400	3	4
	1000	1	1

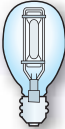
	Power [W]	Number of switchable lamps	
		E 250 - 16 A	E 250 - 32 A
Metal halide and high pressure mercury vapor lamps (HQL)			
	50	30	40
	80	18	25
	125	12	16
	250	6	8
	400	3	5
	1000	1	2

	Power [W]	Number of switchable lamps	
		E 250 - 16 A	E 250 - 32 A
230 V halogen lamps (HQL)			
	150	20	27
	250	12	16
	300	10	13
	400	7	10
	500	6	8
	1000	3	4

	Power [W]	Number of switchable lamps	
		E 250 - 16 A	E 250 - 32 A
Very low voltage halogen lamps (12 or 24 V AC)			
	20	116	160
	50	46	64
	75	31	42
	100	24	32
	150	15	21
	200	12	16
300	7	10	

Use of lighted pushbuttons

Latching relays can be controlled through lighted pushbuttons, without any limitations in terms of connection of three-terminal types.

In two-terminals pushbuttons the current that flows through pushbutton lamps can trigger an unwanted activation; in order to avoid this there is the E 250 CP compensation module, installed in parallel on the coil.

Number of E 250 CP compensation modules	Number of connectable lighted pushbuttons	
	1P – 2P types	3P – 4P types
0	8	9
1	18	22
2	45	38

Maximum length of very low voltage connections

Too long feeding cables can cause a drop in the supply voltage, which could be inadequate for guaranteeing standard operating conditions of latching relays, in particular for very low voltage types.

For this reason the wiring must not exceed the maximum lengths (outward and return) shown in the table.

U_N	0.5 mm ²	0.75 mm ²	1 mm ²	1.5 mm ²
8 V~	28 m	41 m	55 m	90 m
12 V~	68 m	102 m	136 m	224 m
24 V~	272 m	412 m	548 m	896 m
48 V~	1096 m	1640 m	2184 m	3584 m

Relay DC switching capacity

V DC	E 259	E 250 (16 A a.c.)	E 250 (32 A a.c.)
≤ 12	16	16	32
24	16	16	20
30	16	16	16
48	10	10	10
60	8	8	8
110	5	5	5
230	2	2	2

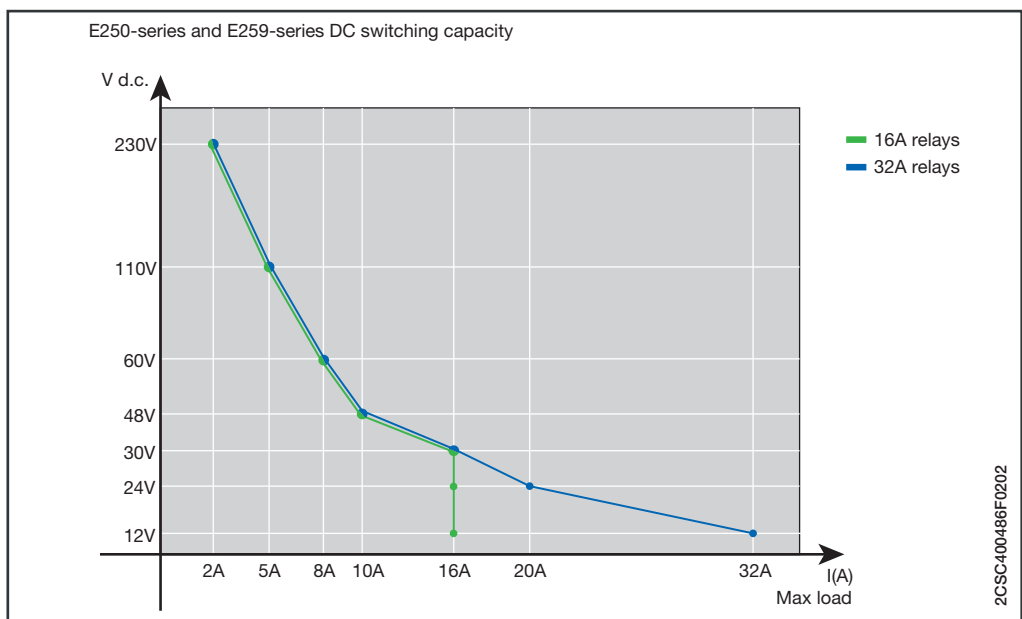

ATT-TOOL

ATT-Tool configuration and programming software allows users to fully customise GSM ATT telephone module to their specific requirements. ATT-Tool has a simple and intuitive interface that allows ATT to be quickly configured without having to remember complicated programming strings or consult a manual to learn the programming syntax. ATT-Tool, available in all the main languages, makes it possible to:

- Add/remove up to 250 users authorised for complete or conditional use of ATT module.
- Add/remove up to 100 recipients of call rings, sms messages, faxes or emails.
- Configure the analog or digital activation mode of the inputs.
- Configure the activation mode of the outputs.
- Define actions to be performed at pre-established intervals.
- Remotely track users and events.
- Customise commands and alerts.
- Perform program debugging.

ATT programming

The following steps describe how to program the device for receiving alarm notifications and remotely controlling loads via mobile phone.

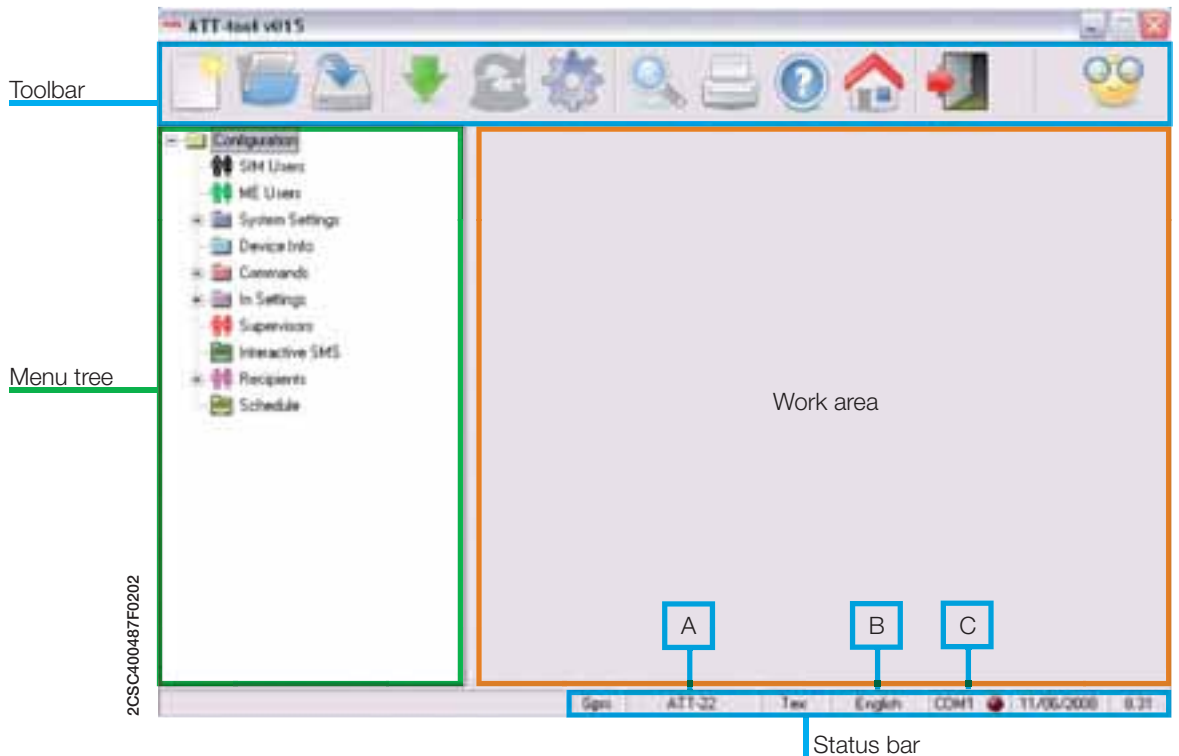

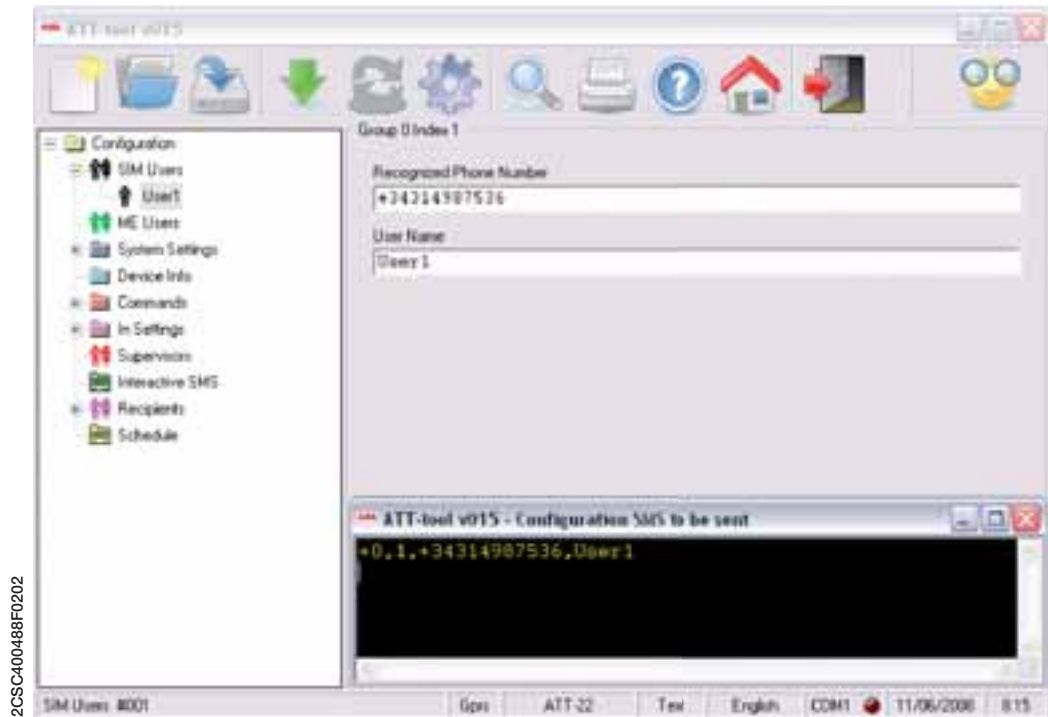

1. Preparing the device

- Insert the SIM inside ATT, positioning it as described in the manual.
- Connect ATT to the serial port of the PC using the cable supplied in the box.
- Insert the battery inside ATT (alternatively, connect the device to a power supply).
- Check the connection to the GSM network (fast constant blinking of "GSM Network" LED).
- Install ATT-Tool on the PC from the CD supplied in the box.
- Start ATT-Tool software.
- Right click with the mouse to select ATT model being used (**A**).
- Right click with the mouse to select the language (**B**).
- Right click with the mouse to select the serial port being used (**C**).



2. Adding users

- Right click on the “SIM Users” item in the menu tree and choose “Add”.
- The  symbol will appear inside the “SIM Users” section
- Enter the user’s name (e.g. User 1)
- Enter the user’s telephone number (e.g. +34314987536). Enter the number with the international dial prefix.
- Right click on the “SIM Users” item in the menu tree and choose “Send”.
- The  symbol changes to  to show that the user has successfully been added.

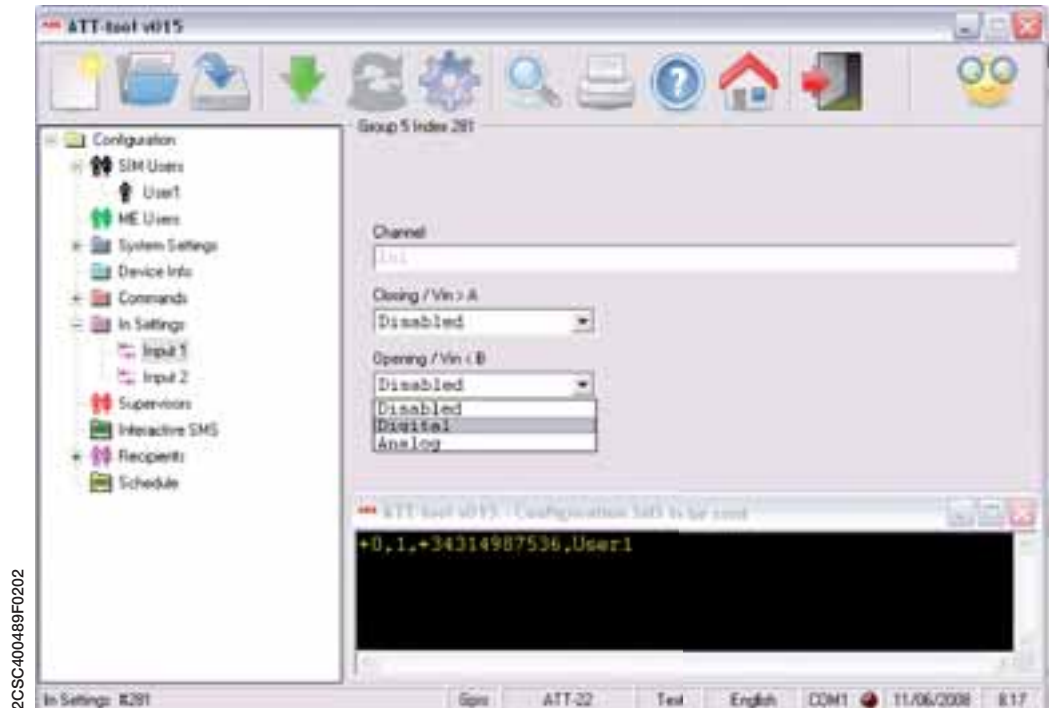



2CSC400489F0202

3. Configuring the inputs

- Click the “+” symbol on the “In settings” item in the menu tree and select “Input 1”.
- Configure the functioning of the inputs: digital (ON/OFF type) or analog (available only for ATT-22 and ATT-22E).

Disabled	Notification of changes in the inputs is disabled.
Digital	Allows ATT to notify when ON/OFF type switching of the inputs occurs.
Analog	Allows ATT to monitor a continuous signal (e.g. temperature) across the (for ATT-22 and ATT-22E) inputs, and issue a notification when it exceeds a preset threshold

- Right click on the “Input 1” item and choose “Send”
- The  symbol changes to  to show that the input has been successfully configured.

To receive a call ring

To receive an SMS

To receive a FAX

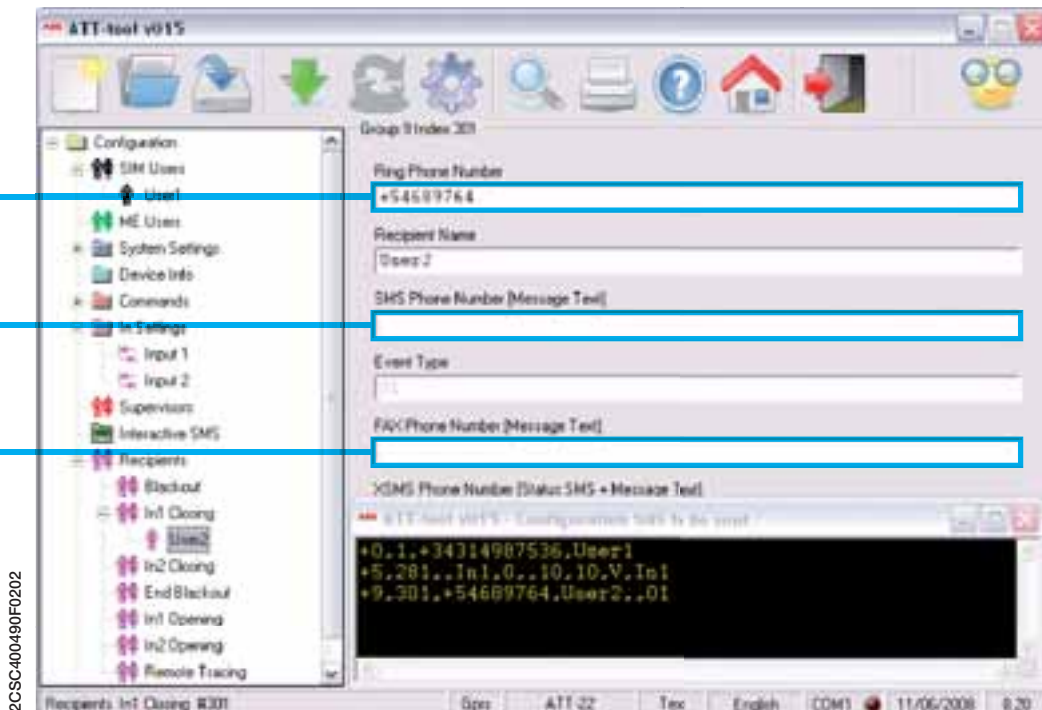

4. Configuring the recipients

- Click on the “+” symbol next to the “Recipients” item in the menu tree.
- Select the event to be notified (e.g. in1 Closing, the ATT notifies when contact 1 closes).
- Enter the name of the recipient of the notification (e.g. User2). Note that the user does not have to be the same one entered in step 2.
- Enter the telephone number (e.g. +54689764) in the desired field, as follows:
- Repeat the procedure to add other recipients or to set up notifications for other inputs.

2CSC400490F0202



5. Transferring the data

- Click on the “Write” symbol
- Enter the PIN of the device and click “OK”. If the SIM does not have a personal PIN enter “0000”.
- Enable all the fields and click “OK”.
- When the data transfer is complete, ATT module is ready for use.

Remote programming via mobile phone

It is also possible to perform quick configuration of ATT module without using ATT-Tool software. Use the following procedure to remotely command the loads connected to ATT and receive notifications in real time.

- 1- Insert ATT SIM into your own mobile phone.
- 2- Save onto that SIM the mobile phone number (administrator) from which ATT is to be controlled.
- 3- Replace the SIM inside ATT.
- 4- Install and wire ATT as shown in the electrical diagram (connecting the load to be monitored to input 1)
- 5- Send an SMS from the telephone number chosen in step 2 (administrator) to the number of the SIM inside ATT, containing the following text:

+9, , , , SMS recipient number,01, , , ,Text example: +9, , , , +3984675,01, , , ,Alarm pump 1

- In this case the administrator will be alerted with an “Alarm pump 1” SMS as soon as input 1 of ATT closes.
- The administrator can also activate ATT output relay by :
 - Sending an SMS to ATT number, containing the text “S1” (to activate OUT1) or “S2” (to activate OUT2).
 - A free call ring to ATT number to activate output 1

ANALOGUE MEASUREMENT INSTRUMENTS

Wiring diagrams

Power factor meters with alternated current – Single-phase line

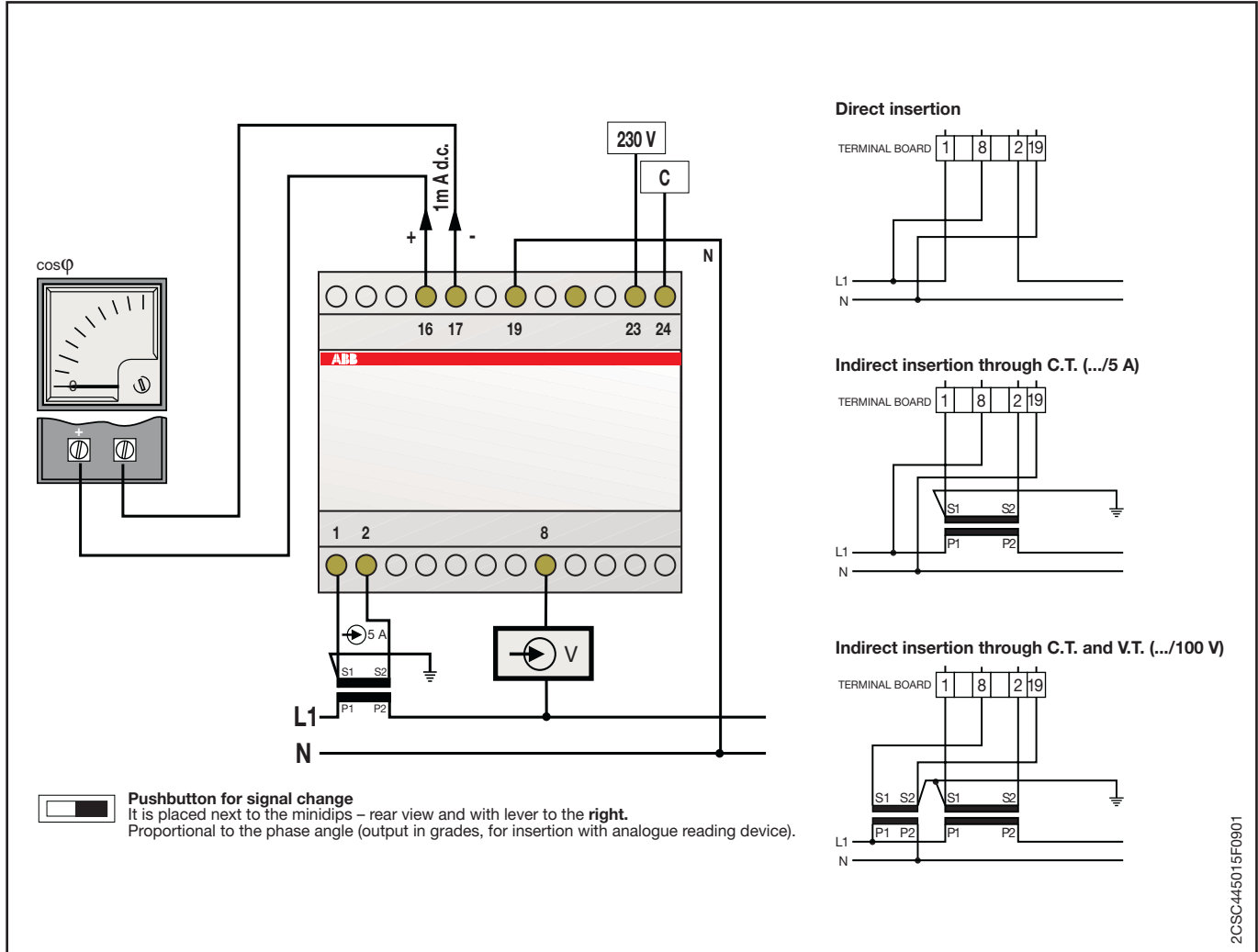

Alternated current power factor meters – Three-phase line without neutral (3 wires)

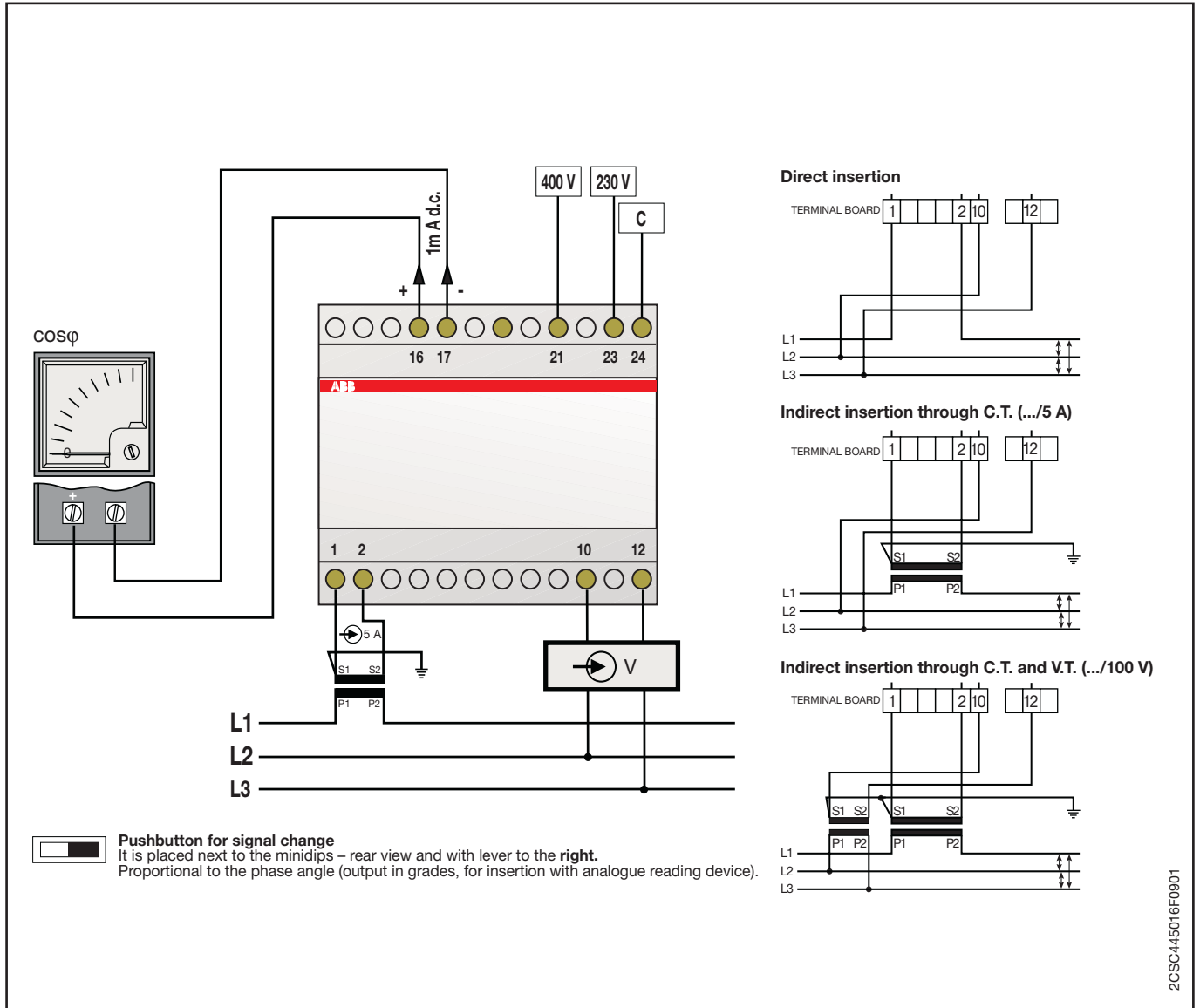

DMTME MULTIMETERS

The DMTME series instruments are digital multimeters that measure the true rms value of the principal electrical quantities in 230/400 V a.c. networks, with the ability to store in memory the maximum/minimum/average measured values, and meter active and reactive energy.

Four red LED displays provide a clear local read-out of multiple measurements simultaneously.

The DMTME multimeters perform the functions of a voltmeter, ammeter, power factor meter, wattmeter, varmeter, frequency meter, active and reactive energy meter in a single instrument, thus substantially reducing installation space requirements and wiring time.

The DMTME-I-485 version is additionally equipped with a pulse output and RS485 port for communicating the measured parameters via a Modbus network.

All versions come with a mini CD containing the instruction manuals, technical documentation, communication protocol and the DMTME-SW software.

The main innovations of the range are:

- Automatic recognition of the C.T. connection polarity, which simplifies installation of the instrument, making it error-proof.
- An hour counter for scheduled maintenance and an instrument life time display, to assist the installer with routine activities.
- Separate auxiliary 115/230 V a.c. power supply on all models, with extractable terminal blocks.

The DMTME-SW software can perform real-time acquisition of all the readings of a multimeter or network of DMTME multimeters, with the values displayed in a single on-screen window. The measurements are shown in both numeric and “analog instrument” format.

DMTME-SW also functions as a simple Modbus communication test instrument, allowing the installer to check the correct operation of the network prior to testing by the system integrator.

Configuration example of networked DMTME multimeters

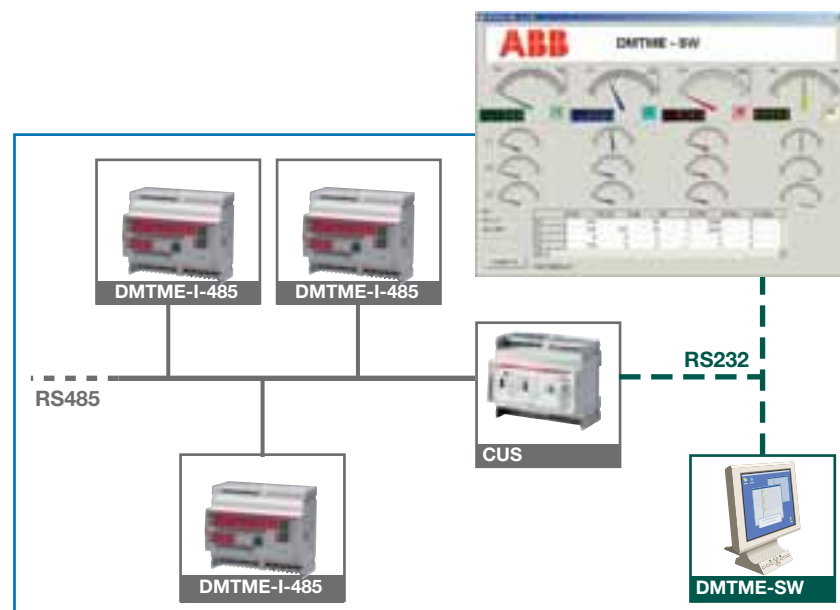

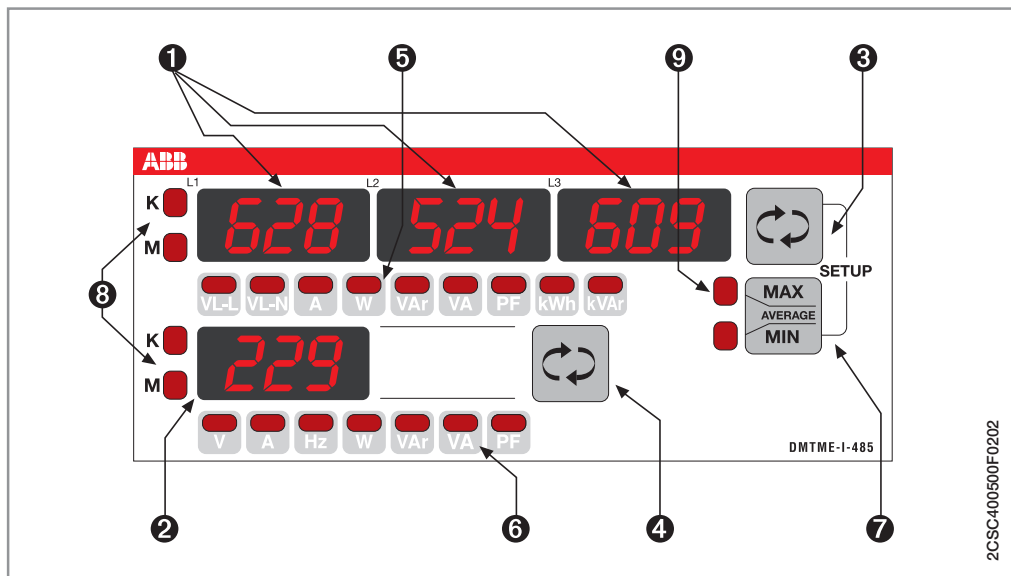

Description of the instrument

- ① Displays L1, L2, L3 for showing the electrical parameters of each phase, and the energy meters and hour counters. The illuminated dot to the right of the digits on the third display (L3) blinks during the RS485 communication (only for the DMTME-I-485 version).
- ② Fourth display for showing the electrical parameters of the three-phase system.
- ③ Button for scrolling through the energy meters and the electrical parameters of each phase shown on displays L1, L2, L3 (①); pressing and holding this button returns to the preceding value.
- ④ Button for scrolling through the three-phase electrical parameters shown on the fourth display (②), and the hour counters; pressing an holding down this button returns to the preceding value.
- ⑤ Nine LEDs which identify the electrical parameters being shown on the first three displays L1, L2, L3. (①)
- ⑥ Seven LEDs which identify the electrical parameters being shown on the fourth display (②).
- ⑦ Button for selecting whether to display the maximum values (MAX LED (⑨) lights up), minimum values (MIN LED (⑨) lights up) or average values over 15 minutes (AVERAGE, MIN and MAX LED (⑨) simultaneously light up) of the electrical parameters. Once the LED indicating the selected display mode lights up, buttons (③) and (④) can be used to scroll through the various electrical parameters.
- ⑧ LED indicating the scale of the electrical parameters shown on displays (①) and (②) of the instrument (factors K= kilo, parameter x 1000, M = mega, parameter x 1,000,000.).
- ⑨ LED indicating whether maximum, minimum or average values are being shown on displays (①) and (②).
- ③ + ⑦ Pressed at the same time invoke the configuration (set up) menu.

Communication networks with Modbus RTU protocol

Modbus is a serial communication protocol created for use with programmable logic controllers (PLC). It has become an industry standard and is the most widely used protocol for connecting of industrial electronic devices.

Its principal benefits are:

- * Ease of use
- * Low resource requirements
- * Openly published and royalty-free
- * Allows communication between many devices connected to the same network

The Modbus support was created for controlling transfer on the line and pipeline monitoring. The system's flexibility and reliability make it suitable for a wide variety of processes and operations in nearly every industry.

Modbus determines how many MASTERS and SLAVES to recognise and connect together, how many senders and receivers are identified, how many messages are exchanged in an orderly manner and how many errors occur. Every peripheral that needs to communicate via Modbus is assigned a unique address. Any one of them can then send a Modbus command, although generally (necessarily, in the case of serial) only one peripheral acts as a master. A Modbus command contains the Modbus address of the peripheral it is intended for, and only that peripheral will act on the command, even though all the others receive it as well. All Modbus commands incorporate control information to ensure that the received command is correct.

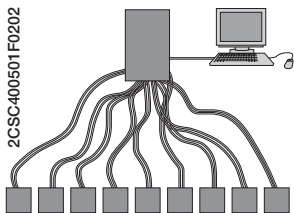

Conventional I/O system

Plus

- Field devices unaffected from wiring error caused by other devices thanks to independent wiring
- Devices are cheaper
- Well known technology

Minus

- Higher installation complexity caused by:
 - point to point wiring
 - many terminal blocks, need additional rack space or more cabinets
 - troubleshooting on complex wiring
 - increased number of point of failure
 - longer initial check and start up
- Expensive installation

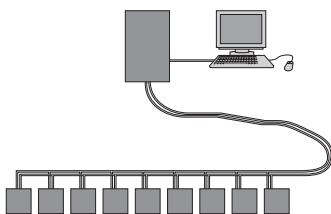

Modbus Network

Plus

- Well known protocol, fully documented
- Many PLC, DCS and process systems are supporting this protocol
- Many facilities already use it
- Optimum choice when:
 - Modbus network or devices are being used
 - Modbus protocol is already used as a facility standard

Minus

- Device operations require separate power
- Limited diagnostic capabilities (device applications)
- Limited use as a device bus

Unicast mode

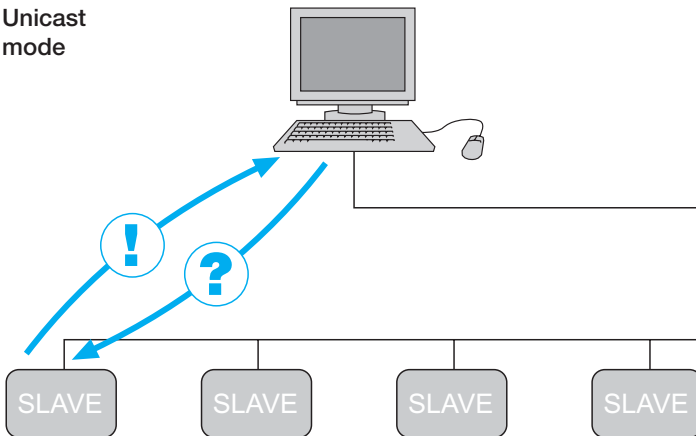

The protocol has one Master and up to 247 Slaves on a common line covering a maximum distance of 1200 metres. Only the Master initiates transactions. The transactions are of the request/reply type (addressed to a single Slave) or of the broadcast/reply type (addressed to all Slaves).

Modbus is often used for connecting a supervisory computer with a remote terminal unit (RTU) in supervisory control and data acquisition systems (SCADA). There are two versions of the protocol: one for serial ports (RS232 by default, but also RS485) and one for Ethernet.

Modbus uses a compact hexadecimal data representation. The RTU format appends to commands/data a cyclic redundancy checksum (CRC) field, while the ASCII format uses an LRU type (longitudinal redundancy check) checksum.

Broadcast mode

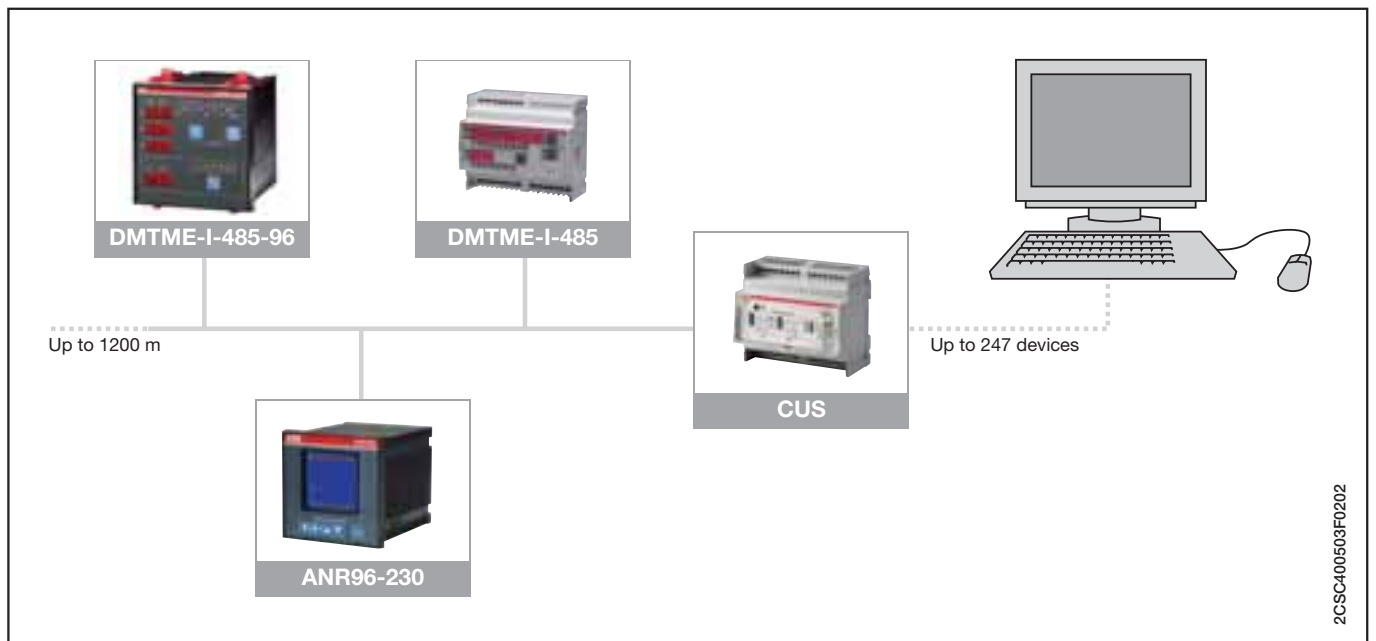
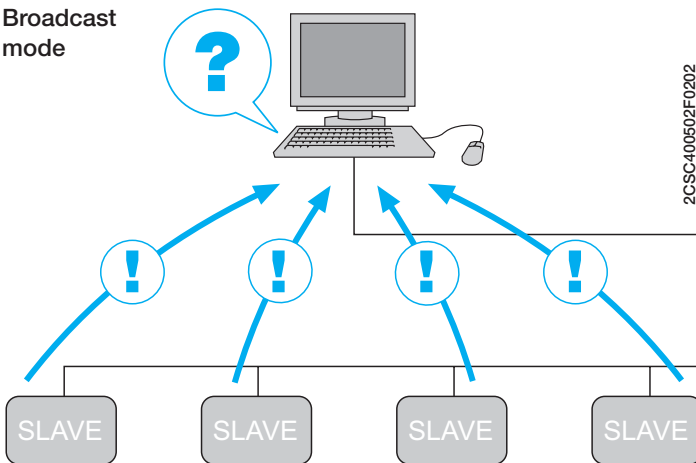

Temperature control units

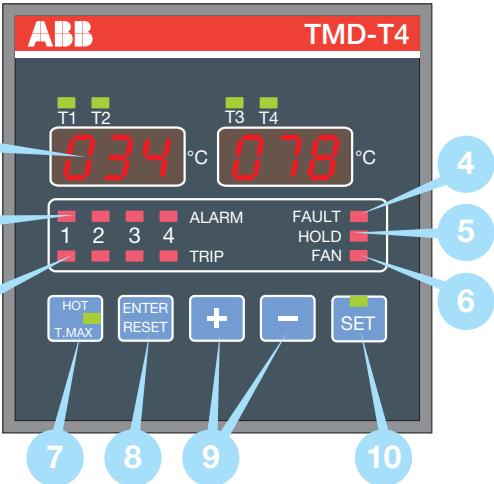



1 Display for viewing temperature values and settings
2 ALARM LED for viewing alarm status of measuring channels
3 TRIP LED for viewing trip status (second-level alarm) of measuring channels
4 FAULT LED for indicating temperature control unit and sensor faults
5 HOLD LED for indicating whether manual reset function is enabled
6 FAN LED for indicating whether fan output is enabled
7 MAX T. pushbutton for selecting to view the max temperature level
8 ENTER/RESET pushbutton for confirming the programmed settings and for manually resetting any alarms that have been tripped
9 +/- pushbuttons for selecting the measuring channels and for adjusting the programming parameters
10 SET pushbutton with status LED for accessing and programming the device's settings

2CSC400504F0202

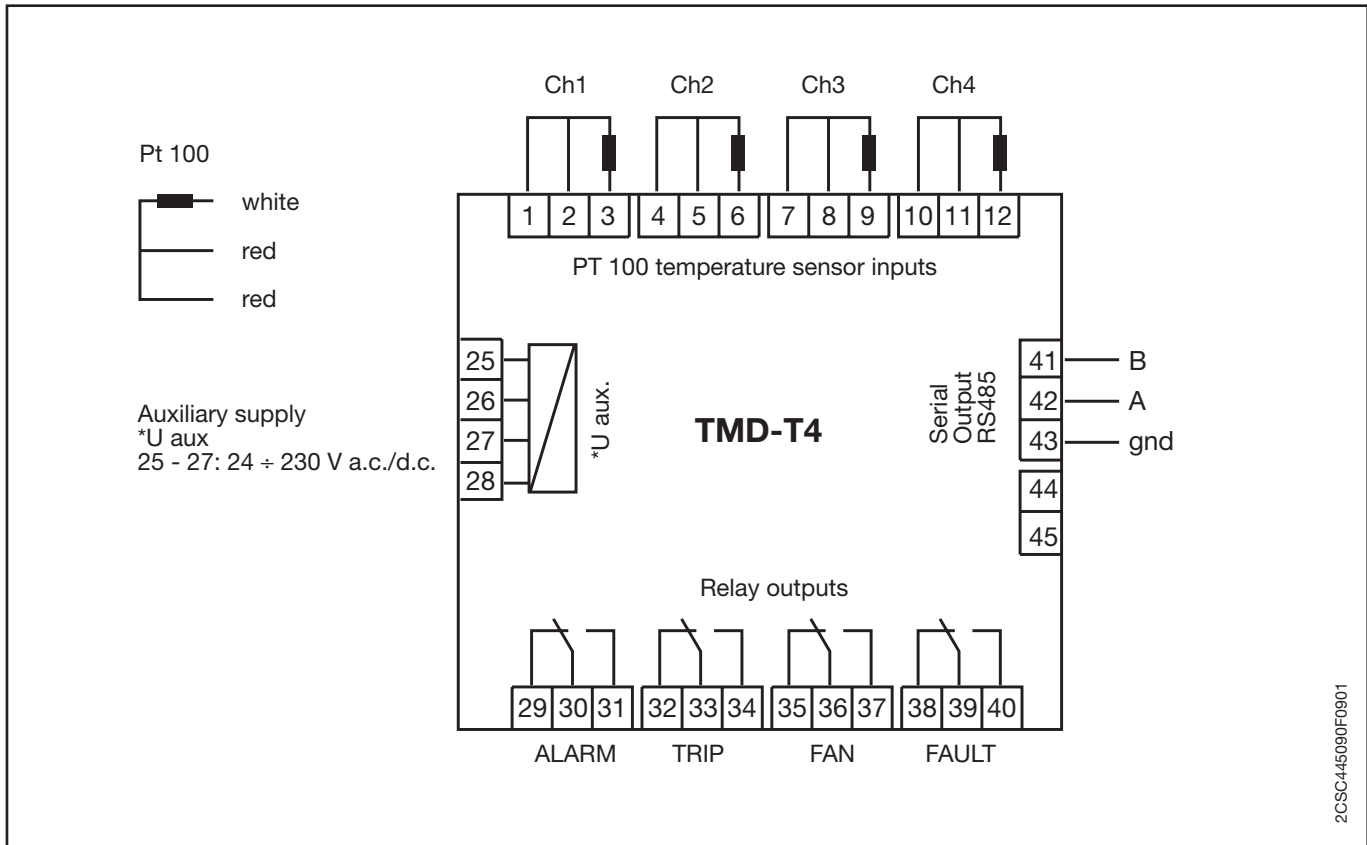
TMD-T4



Standard type current transformer

TYPE		CT-3	CT-4	CT-6	CT-8	CT-12	CT-8V	CT-12V
OPERATION		Through primary						
CENTRAL SECTION	 HORIZ. BAR	20x10 30x10	30x10	50x20 60x20	60x30 80x30	80x50 100x50 125x50		
	 CABLE	21	25	50	2x30	2x50	2x35	3x35
	 VERT. BAR	20x10	30x10				min. 80x30 + max. 3x80x5	min. 100x10 + max. 4x125x5
Primary current (A)	Power (VA)	Power (VA)		Power (VA)	Power (VA)	Power (VA)	Power (VA)	Power (VA)
	Rating	0.5 1 3	0.5 1 3	Rating 0.5	Rating 0.5	Rating 0.5	Rating 0.5	Rating 0.5
1								
5								
10								
15								
20								
25								
30								
40								1.5
50								2
60								2
80								3
100		2.5						
150	3				3			
200	3				4			
250	5				6			
300	5		6		5	5		
400	6		10		6	6		6
500	6		10		6	10	10	10
600	6		10		10	10	10	10
800			10		10	10	15	10 10
1000			10		20	10	20	10 10
1200					20	15	20	10 10
1500					30	20	20	10 10
2000					30	20	30	20 12
2500					30	20	40	20 15
3000						20	40	20
4000							50	20
5000							50	
6000							50	
DIMENSIONS	Height	75	87		120	175	119	165
	Width	58	75	105	125	180	109	109
	Depth	44	44	61	61.5	68.5	41	41

Assembly

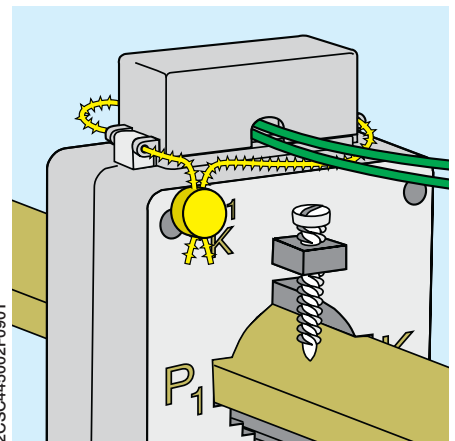
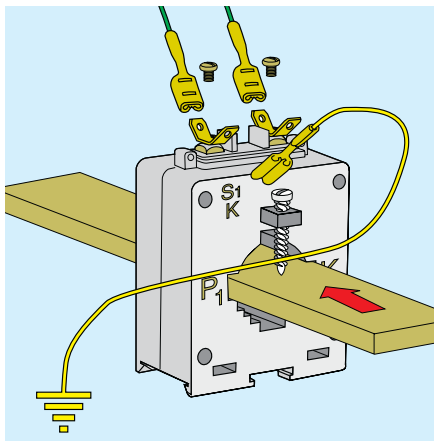
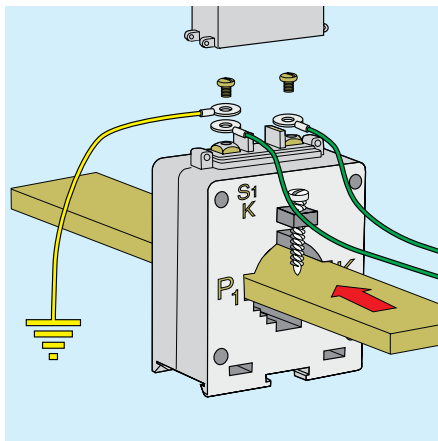
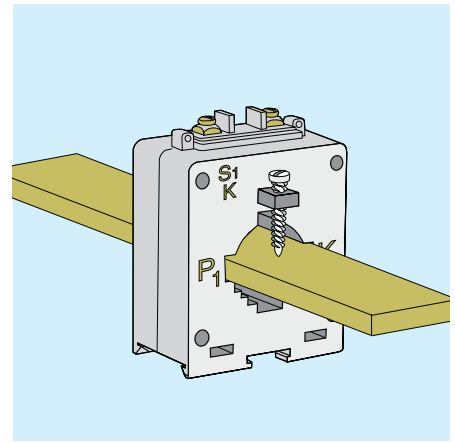
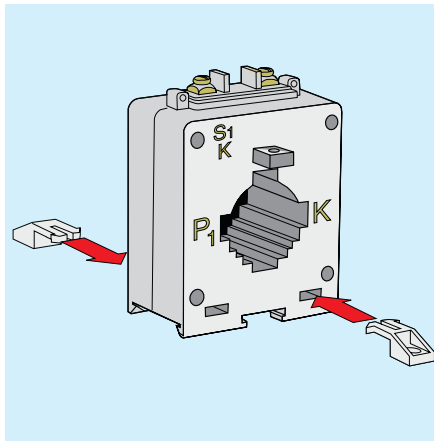
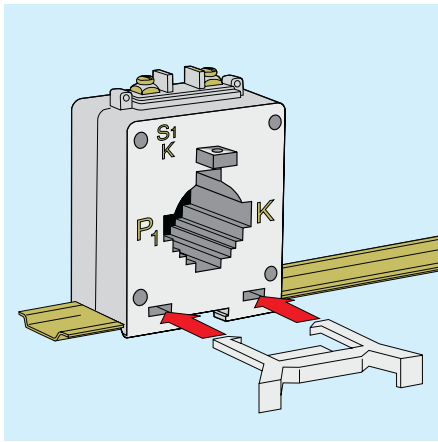

Power consumption of copper cables between the device and the transformer

For 5 A secondary

Cable section mm ²	Power (two-pole cable) VA VA					
	Distance					
	1 m	2 m	4 m	6 m	8 m	10 m
1.5	0.58	1.15	2.31	3.46	4.62	5.77
2.5	0.36	0.71	1.43	2.14	2.86	3.57
4	0.22	0.45	0.89	1.34	1.79	2.24
6	0.15	0.30	0.60	1.89	1.19	1.49
10	0.09	0.18	0.36	0.54	0.71	0.89

Maximum load (A) on copper bars according to DIN 43670 and 43671

Bar dimensions mm	Rated current (In) A		
	1 bar	2 bars	3 bars
20x5	325	560	
20x10	427	925	1180
30x5	379	672	896
30x10	573	1060	1480
40x5	482	836	1090
40x10	715	1290	1770
50x10	852	1510	2040
60x10	985	1720	2300
80x10	1240	2110	2790
100x10	1490	2480	3260

Rating	Ratio fault limit in %			
	0.05 In	0.2 In	In	1.2 In
0.5	±1	±0.75	±0.5	±0.5
1	±2	±1.5	±1	±1
3	From 0.5 In to 1.2 In = ±3			

Rating	Angle fault limit in %			
	0.05 In	0.2 In	In	1.2 In
0.5	±1.8	±1.35	±0.9	±0.9
1	±3.6	±2.7	±1.8	±1.8
3	No prescriptions			

Accuracy rating

- 0.5 rating is required for power meters.
- 1 rating is required for unofficial power measures and power meters (measurements within the firm).
- 3 rating is required for relays and protection devices.

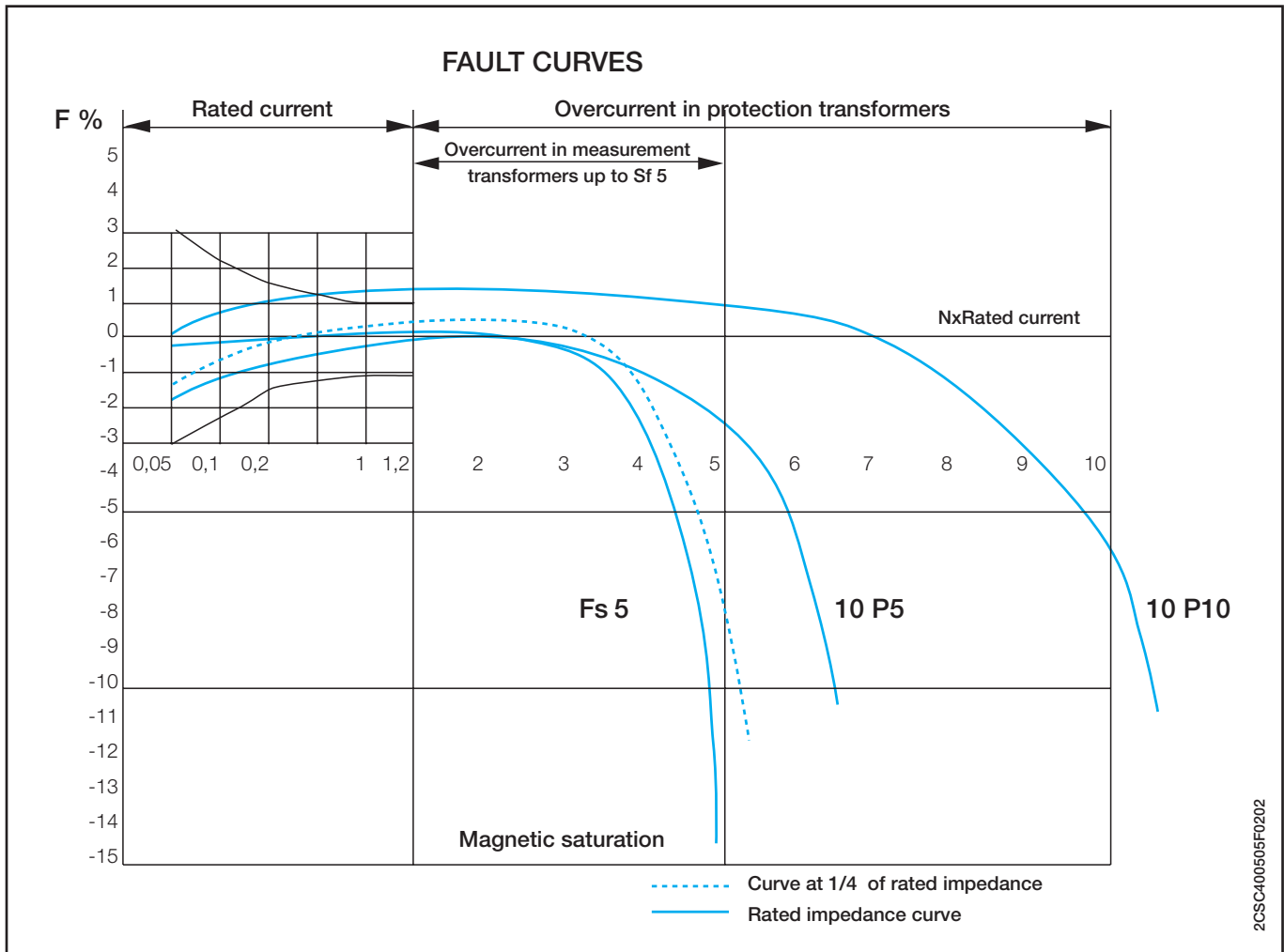

Cable diameter calculation

The following formula applies for determining the diameters of a 95 mm² cable:

- section= $r \times r \times 3.14$ that is $r^2 \times 3.14$ from which $r = \sqrt{\text{section} / 3.14}$ $r = \sqrt{95 / 3.14} = 30.25 = 5.5$ mm, so the radius is 5.5 mm
- diameter= $r+r$ so the diameter is $5.5+5.5$ mm= 11 mm (copper diameter to be added to the insulating material thickness, total \varnothing about 20 mm).

With many insertion of the cable into the current transformer it is possible to halve the primary current while performance and rating values remain unaltered.

Example

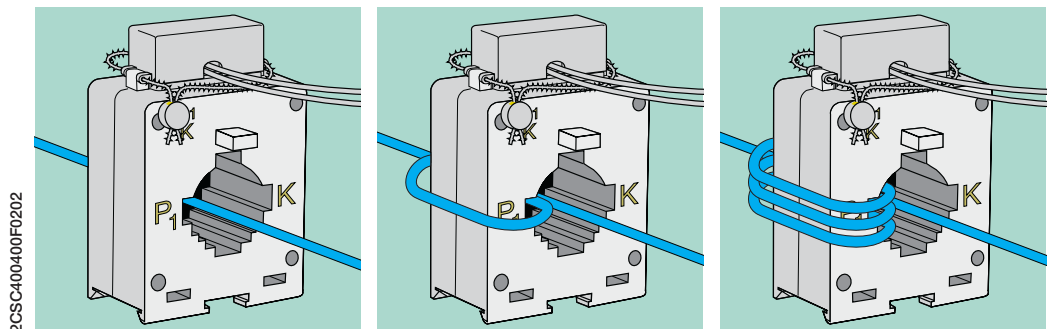



2CSC400119F0201

SUMMING CURRENT TRANSFORMERS

The examples shown below refer to the connection to an ammetric phase. For the connection to two systems (ARON) it is necessary to use two summing transformers and two ammetric transformers (respectively for phase L1 and for phase L3).

For the connection to three systems it is necessary to use two summing transformers and three ammetric transformers (respectively for phase L1, for phase L2 and for phase L3).

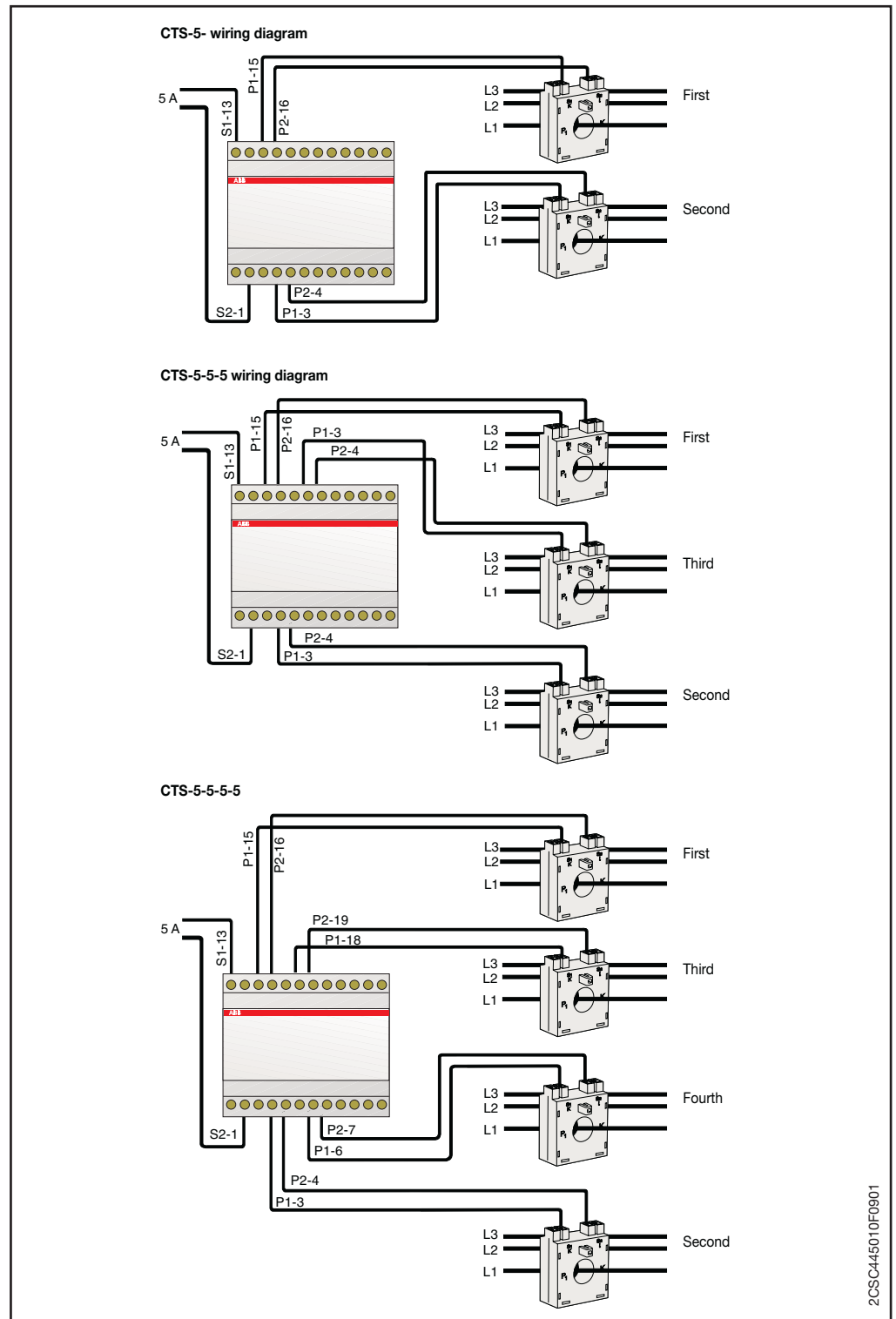

2CSC445010F0901

CURRENT AND VOLTAGE CONVERTERS

Technical characteristics

		Ammetric converters	Voltmetric converters
		in a.c./d.c.	in a.c./d.c.
Auxiliary supply (separated)	[V]	a.c. 230	a.c. 230
Input rated values		1-5 A	120-300-500 V
Output rated values	[V d.c.]	1-5-10	1-5-10
	[mA d.c.]	1-5-10-4...20	1-5-10-4...20
Ohmic load	[Ω]	700	700
Measurement field		0±In	0±Un
Accuracy rating		0.5	0.5
Overload			
Permanent		2 In	2 Un
Instantaneous		10 In/1 sec.	10 Un/1 sec.
Frequency	[Hz]	50/60	50/60
Time delay	[ms]	≤300	≤300
Alternated residue		≤1%	≤1%
Self-consumption		current ≤0,8 VA aux. supply ≤4 VA	voltage ≤1 VA aux. supply ≤4 VA
Input/output galvanic separation			
Input/output insulation, aux. supply		2 kV/50 Hz -1 min	2 kV/50 Hz -1 min
Circuit/mass insulation		4 kV/50 Hz -1 min	4 kV/50 Hz -1 min
Operating temperature	[°C]	0...+55	0...+55
Dimensions		3-6 DIN modules	3-6 DIN modules
Weight	[kg]	0.30	0.30

Current converters (a.c. input)

4 20 mA d.c.
20 mA d.c.
10 V d.c. 10 mA d.c.
5 V d.c. 5 mA d.c.
1 V d.c. 1 mA d.c.

7 8 9 10 11 12

1 2 3 4 5 6

Supply

1 A MAX

5 A MAX

Input signal (A)

The output selection must be performed by moving the programming pushbuttons according to the specific needs.

SELECTABLE OUTPUTS

	1	2	3	4	5	6	1	2	3	4	5	6	1	2	3	4	5	6	1	2	3	4	5	6		
1 mA	□	□	□	□	□	□	□	□	□	□	□	□	□	□	□	□	□	□	□	□	□	□	□	□		
5 mA	■	□	□	□	□	□	■	□	□	□	□	□	■	□	□	□	□	□	■	□	□	□	□	□		
10 mA	□	□	□	□	□	□	□	□	□	□	□	□	□	□	□	□	□	□	□	□	□	□	□	□		
20 mA	□	□	□	□	□	□	□	□	□	□	□	□	□	□	□	□	□	□	□	□	□	□	□	□		
	■	■	■	■	■	■	■	■	■	■	■	■	■	■	■	■	■	■	■	■	■	■	■	■		
						OFF					OFF					OFF					OFF					OFF
						ON					ON					ON					ON					ON

If a V output has been selected it is necessary to connect terminals 7 and 8, while for mA outputs the terminals 11 and 12 must be connected.

The input selection is performed by connecting the terminal of the common C (n. 6) to the terminal 4, for a 1 A input, and to the terminal 5 for a 5 A input.

20SC400507 F0202

Current converters (d.c. input)

The diagram shows the terminal block for current converters. The top row of terminals (13, 14, 17, 18) is labeled with output ranges: 4 20 mA d.c., 20 mA d.c., 10 mA d.c., 5 mA d.c., 1 mA d.c. The bottom row of terminals (7, 8, 10, 12) is labeled with input ranges: 10 V d.c., 5 V d.c., 1 V d.c. The input signal is 60 mV. A supply terminal is also shown.

The output selection table is as follows:

SELECTABLE OUTPUTS													
	1	2	3	4	5	6	1	2	3	4	5	6	
1 mA	OFF	OFF	OFF	OFF	OFF	OFF	OFF	OFF	OFF	OFF	OFF	OFF	1 V
5 mA	ON	OFF	OFF	OFF	OFF	OFF	ON	OFF	OFF	OFF	OFF	OFF	5 V
10 mA	ON	ON	OFF	OFF	OFF	OFF	ON	ON	OFF	OFF	OFF	OFF	10 V
20 mA	ON	ON	ON	OFF	OFF	OFF	ON	ON	ON	OFF	OFF	OFF	4÷20 mA

The output selection must be performed by moving the programming pushbuttons according to the specific needs.

2CSC400508F0202

Voltage converters (a.c. input)

The diagram shows the terminal block for voltage converters. The top row of terminals (7, 8, 9, 10, 11, 12) is labeled with output ranges: 4 20 mA d.c., 20 mA d.c., 10 mA d.c., 5 mA d.c., 1 mA d.c. The bottom row of terminals (1, 2, 3, 4, 5, 6) is labeled with input ranges: 500 V, 300 V, 120 V, and a common terminal C. The input signal is (V). A supply terminal is also shown.

The output selection table is identical to the one above.

If a V output has been selected it is necessary to connect terminals 7 and 8, while for mA outputs the terminals 11 and 12 must be connected.

The input selection is performed by connecting the terminal of the common C (6) to the terminal 5, for a 120 V input, or to the terminal 4 for a 300 V input or to the terminal 3 for a 500 V input.

2CSC400509F0202

Voltage converters (d.c. input)

4 20 mA d.c.
20 mA d.c.
10 mA d.c.
5 mA d.c.
1 mA d.c.

10 V d.c.
5 V d.c.
1 V d.c.

13 14 17 18

7 8 10 12

Supply

Input signal 60 mV

120 V 300 V 500 V

INPUT SIGNAL SELECTION

The cables of the selected inputs must be connected to terminals 4 and 6.

The output selection must be performed by moving the programming pushbuttons according to the specific needs.

SELECTABLE OUTPUTS																								
	1	2	3	4	5	6	1	2	3	4	5	6	1	2	3	4	5	6	1	2	3	4	5	6
1 mA	<input type="checkbox"/>	<input type="checkbox"/>	<input type="checkbox"/>	<input type="checkbox"/>	<input type="checkbox"/>	<input type="checkbox"/>	<input type="checkbox"/>	<input type="checkbox"/>	<input type="checkbox"/>	<input type="checkbox"/>	<input type="checkbox"/>	<input type="checkbox"/>	<input type="checkbox"/>	<input type="checkbox"/>	<input type="checkbox"/>	<input type="checkbox"/>	<input type="checkbox"/>	<input type="checkbox"/>	<input type="checkbox"/>	<input type="checkbox"/>	<input type="checkbox"/>	<input type="checkbox"/>	<input type="checkbox"/>	<input type="checkbox"/>
	■	■	■	■	■	■	■	■	■	■	■	■	■	■	■	■	■	■	■	■	■	■	■	■
						OFF						OFF					OFF						OFF	
						ON						ON					ON						ON	
5 mA	<input type="checkbox"/>	<input type="checkbox"/>	<input type="checkbox"/>	<input type="checkbox"/>	<input type="checkbox"/>	<input type="checkbox"/>	<input type="checkbox"/>	<input type="checkbox"/>	<input type="checkbox"/>	<input type="checkbox"/>	<input type="checkbox"/>	<input type="checkbox"/>	<input type="checkbox"/>	<input type="checkbox"/>	<input type="checkbox"/>	<input type="checkbox"/>	<input type="checkbox"/>	<input type="checkbox"/>	<input type="checkbox"/>	<input type="checkbox"/>	<input type="checkbox"/>	<input type="checkbox"/>	<input type="checkbox"/>	
	■	■	■	■	■	■	■	■	■	■	■	■	■	■	■	■	■	■	■	■	■	■	■	
						OFF						OFF					OFF						OFF	
						ON						ON					ON						ON	
10 mA	<input type="checkbox"/>	<input type="checkbox"/>	<input type="checkbox"/>	<input type="checkbox"/>	<input type="checkbox"/>	<input type="checkbox"/>	<input type="checkbox"/>	<input type="checkbox"/>	<input type="checkbox"/>	<input type="checkbox"/>	<input type="checkbox"/>	<input type="checkbox"/>	<input type="checkbox"/>	<input type="checkbox"/>	<input type="checkbox"/>	<input type="checkbox"/>	<input type="checkbox"/>	<input type="checkbox"/>	<input type="checkbox"/>	<input type="checkbox"/>	<input type="checkbox"/>	<input type="checkbox"/>	<input type="checkbox"/>	
	■	■	■	■	■	■	■	■	■	■	■	■	■	■	■	■	■	■	■	■	■	■	■	
						OFF						OFF					OFF						OFF	
						ON						ON					ON						ON	
20 mA	<input type="checkbox"/>	<input type="checkbox"/>	<input type="checkbox"/>	<input type="checkbox"/>	<input type="checkbox"/>	<input type="checkbox"/>	<input type="checkbox"/>	<input type="checkbox"/>	<input type="checkbox"/>	<input type="checkbox"/>	<input type="checkbox"/>	<input type="checkbox"/>	<input type="checkbox"/>	<input type="checkbox"/>	<input type="checkbox"/>	<input type="checkbox"/>	<input type="checkbox"/>	<input type="checkbox"/>	<input type="checkbox"/>	<input type="checkbox"/>	<input type="checkbox"/>	<input type="checkbox"/>	<input type="checkbox"/>	
	■	■	■	■	■	■	■	■	■	■	■	■	■	■	■	■	■	■	■	■	■	■	■	
						OFF						OFF					OFF						OFF	
						ON						ON					ON						ON	

2CSC4005110F0202



TRANSDUCERS FOR ANGLE PHASE METERS

Single-phase line and input and output selection

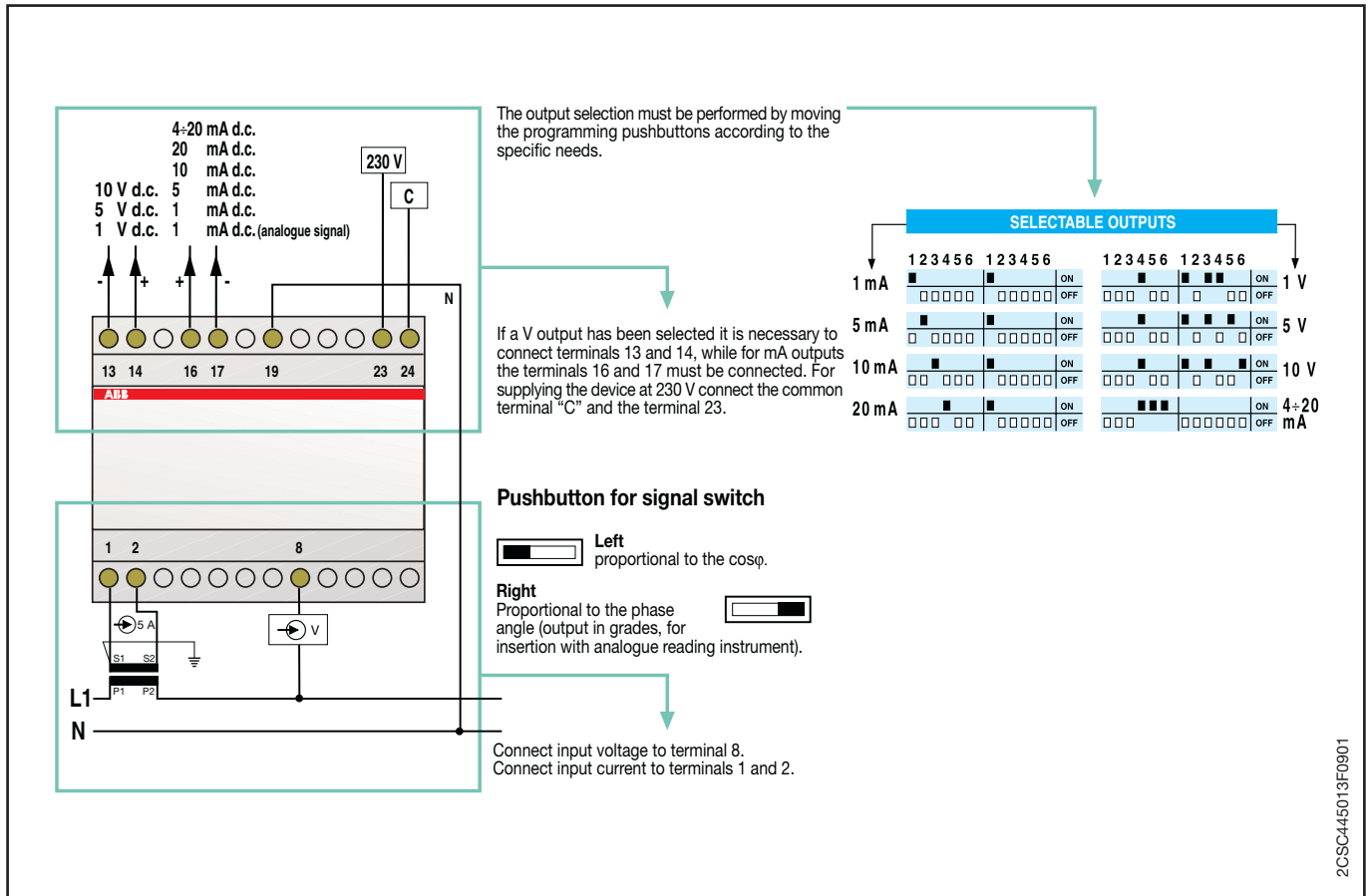

2CSC445013F0901

Balanced three-phase line without neutral (3 wires)

The output selection must be performed by moving the programming pushbuttons according to the specific needs.

If a V output has been selected it is necessary to connect terminals 13 and 14, while for mA outputs the terminals 16 and 17 must be connected. For supplying the device at 230 V connect the common terminal "C" and the terminal 23, while for a 400 V supply it is necessary to connect the common terminal "C" and the terminal 21.

Pushbutton for signal switch

Left
Proportional to the $\cos\phi$.

Right
Proportional to the phase angle (output in grades, for insertion with analogue reading instrument).

Connect input voltage to terminals 10 and 12.
Connect input current of L1 phase to terminals 1 and 2.

SELECTABLE OUTPUTS															
		1	2	3	4	5	6	1	2	3	4	5	6		
1 mA	■	□	□	□	□	■	□	ON	■	□	□	□	□	□	1 V
	□	□	□	□	□	□	□	OFF	□	□	□	□	□		
5 mA	■	□	□	□	□	■	□	ON	■	□	□	□	□	5 V	
	□	□	□	□	□	□	□	OFF	□	□	□	□	□		
10 mA	■	□	□	□	□	■	□	ON	■	□	□	□	□	10 V	
	□	□	□	□	□	□	□	OFF	□	□	□	□	□		
20 mA	■	□	□	□	□	■	□	ON	■	□	□	□	□	4÷20 mA	
	□	□	□	□	□	□	□	OFF	□	□	□	□	□		

2CSC445014F0901

Unbalanced three-phase line without neutral (3 wires)

The outputs must be selected by shifting the programming keys depending on your needs at the time.

If an output in V has been selected, you need to connect terminals 13 and 14 whereas you need to connect terminals 16 and 17 if the selected output is in mA.
To power the instrument on 230V connect the common terminal C to terminal 23 whereas to power it on 400V you must connect the common terminal C to terminal 21.

AVAILABLE OUTPUTS

AVAILABLE OUTPUTS															
		1	2	3	4	5	6	1	2	3	4	5	6		
1 mA	■	□	□	□	□	■	□	ON	■	□	□	□	□	1 V	
	□	□	□	□	□	□	□	OFF	□	□	□	□	□		
5 mA	■	□	□	□	□	■	□	ON	■	□	□	□	□	5 V	
	□	□	□	□	□	□	□	OFF	□	□	□	□	□		
10 mA	■	□	□	□	□	■	□	ON	■	□	□	□	□	10 V	
	□	□	□	□	□	□	□	OFF	□	□	□	□	□		
20 mA	■	□	□	□	□	■	□	ON	■	□	□	□	□	4÷20 mA	
	□	□	□	□	□	□	□	OFF	□	□	□	□	□		

2CSC445033F0901



Balanced three-phase line with neutral (4 wires)

The outputs must be selected by shifting the programming keys depending on your needs at the time.

If an output in V has been selected, you need to connect terminals 13 and 14 whereas you need to connect terminals 16 and 17 if the selected output is in mA. To power the instrument on 230V connect the common terminal C to terminal 23 whereas to power it on 400V you must connect the common terminal C to terminal 21.

AVAILABLE OUTPUTS																									
	1	2	3	4	5	6	1	2	3	4	5	6	1	2	3	4	5	6	1	2	3	4	5	6	
1 mA	■	■	■	■	■	■	■	■	■	■	■	■	■	■	■	■	■	■	■	■	■	■	■	■	ON
	□	□	□	□	□	□	□	□	□	□	□	□	□	□	□	□	□	□	□	□	□	□	□	□	OFF
5 mA	■	■	■	■	■	■	■	■	■	■	■	■	■	■	■	■	■	■	■	■	■	■	■	■	ON
	□	□	□	□	□	□	□	□	□	□	□	□	□	□	□	□	□	□	□	□	□	□	□	□	OFF
10 mA	■	■	■	■	■	■	■	■	■	■	■	■	■	■	■	■	■	■	■	■	■	■	■	■	ON
	□	□	□	□	□	□	□	□	□	□	□	□	□	□	□	□	□	□	□	□	□	□	□	□	OFF
20 mA	■	■	■	■	■	■	■	■	■	■	■	■	■	■	■	■	■	■	■	■	■	■	■	■	ON
	□	□	□	□	□	□	□	□	□	□	□	□	□	□	□	□	□	□	□	□	□	□	□	□	OFF

2CSC445034F0901

Unbalanced three-phase line with neutral (4 wires)

The outputs must be selected by shifting the programming keys depending on your needs at the time.

If an output in V has been selected, you need to connect terminals 13 and 14 whereas you need to connect terminals 16 and 17 if the selected output is in mA. To power the instrument on 230V connect the common terminal C to terminal 23; whereas to power it on 400V you must connect the common terminal C to terminal 21.

AVAILABLE OUTPUTS																									
	1	2	3	4	5	6	1	2	3	4	5	6	1	2	3	4	5	6	1	2	3	4	5	6	
1 mA	■	■	■	■	■	■	■	■	■	■	■	■	■	■	■	■	■	■	■	■	■	■	■	■	ON
	□	□	□	□	□	□	□	□	□	□	□	□	□	□	□	□	□	□	□	□	□	□	□	□	OFF
5 mA	■	■	■	■	■	■	■	■	■	■	■	■	■	■	■	■	■	■	■	■	■	■	■	■	ON
	□	□	□	□	□	□	□	□	□	□	□	□	□	□	□	□	□	□	□	□	□	□	□	□	OFF
10 mA	■	■	■	■	■	■	■	■	■	■	■	■	■	■	■	■	■	■	■	■	■	■	■	■	ON
	□	□	□	□	□	□	□	□	□	□	□	□	□	□	□	□	□	□	□	□	□	□	□	□	OFF
20 mA	■	■	■	■	■	■	■	■	■	■	■	■	■	■	■	■	■	■	■	■	■	■	■	■	ON
	□	□	□	□	□	□	□	□	□	□	□	□	□	□	□	□	□	□	□	□	□	□	□	□	OFF

2CSC445035F0901



2CSC400515F0202



2CSC400595F0001

MODULAR TRANSFORMERS

The range of System pro M compact modular transformers consists of a series of safety transformers for general use, TS-C with 12-24 V secondary and powers of 25, 40 and 63 VA, the TM range of bell transformers, with secondary voltages of 12-24 V and a maximum rated power of 10-15-30-40 VA, and the TS range of bell transformers, with secondary voltages of 8-12-24 V and a rated secondary power of 8-16-24 VA (some TS types are available with an integrated switch ON/OFF).

Modular safety transformers for general use TS-C, continuous functioning

Standard: IEC EN 61558-2-6

The TS-C safety transformer is an insulation transformer for supplying SELV circuits (with extremely low safety voltage) or PELV circuits (with extremely low protection voltage). In contrast to the bell transformers, TS-C transformers can be used to continuously supply low voltage loads and they have a reduced voltage drop value. Even after a short-circuit they maintain their temperature below the specified limits. In addition they are equipped with a thermal sensitive restoring device which automatically restores power when the transformer is sufficiently cooled down or the overload has been removed.

Fail proof bell transformers TM series

Standard: IEC EN 61558-2-8

Following a short-circuit or an overload use the products may not continue to operate, but they continue assuring separation between primary and secondary circuits, safeguarding the user and adjacent electric parts: the serie includes 8 models with 10, 15, 30 and 40 VA power and 4, 8, 12 and 24 V output voltages.

Non-inherently short-circuit proof bell transformers TS series

Standard: IEC EN 61558-2-8

Even after a short-circuit they maintain their temperature below the specified limits. In fact they are equipped with a thermal protection device which automatically restores power when the transformer is sufficiently cooled down or the overload has been removed. The TS series includes 10 models with 8, 16, 24 VA power and output voltages of 4, 6, 8 and 12 and 24 V AC.

The TS8/SW series is equipped with an ON-OFF switch on the front side that allows the control of the load connected to transformer's secondary circuit. It includes 5 models with 8 VA power and output voltages of 4, 6, 8 and 12 V.



CONTROL, ISOLATING AND SAFETY TRANSFORMERS

The choice of supply voltage for a control circuit must take into account two factors: the safety of users, and the functional reliability of the circuits, which can be dependent on the voltage drop.

Control transformer

Reference standard: CEI EN 61558-2-2:

Transformer for supplying control circuits, for example commands, signalling, interlocks, etc.

Isolating transformer

Reference standard: CEI EN 61558-2-4:

Transformer in which the primary and secondary windings are electrically separated by a double or reinforced insulation, to protect the circuit supplied by the secondary against hazards due to accidental simultaneous contact with earth and live parts, or grounded parts that may become live in the event of an insulation fault.

Safety transformer

Reference standard: CEI EN 61558-2-6:

Isolation transformer for supplying safety extra low voltage circuits (<50 V on no load). Accidental contact with the secondary winding phases can be withstood without any danger.

Impregnation and tropicalization

ABB transformers are fully impregnated using a thermal class F resin. This treatment improves the characteristics of the insulating materials, making the transformers suitable for installation in harsh environments. It also augments heat exchanges, thereby lowering the transformer temperature, prevents moisture from penetrating the windings and core, and minimises vibrations and the resultant noise.

Insulation classes

The duration of the insulation in the products depends on many factors, and in cases where the insulating material electrically segregates live parts from accessible parts, any alteration in its characteristics may put the safety of the user at risk.

The standards prescribe maximum temperature limits for transformer windings as a function of the insulation class.

ABB transformers are constructed using class B materials.

The maximum permitted ambient temperature is specified on the transformer rating plate as well as on this catalog.

Insulation class	T MAX
A	100 °C
E	115 °C
B	120 °C
F	140 °C
H	165 °C

Protection of transformers

Protection on primary

On the primary side, the transformer cannot generate any overload by itself. During power up, however, a very high inrush current (approx. 25-30 In) is generated. Protections should therefore be calibrated in order to prevent their tripping during the transformer connection phase. The most suitable types of protection are:

- aM fuses
- S202 miniature circuit breakers, D characteristic.

Minimum protection on primary

Transformer power (VA)		230 V single phase	400 V single phase
50	aM fuse	0.5 A	0.315 A
	aM fuse	1 A	0.63 A
100	Breaker capacity	1.6 A	1 A
	Trip characteristic	D	D
160	aM fuse	1.6 A	1 A
	Breaker capacity	3 A	2 A
200	Trip characteristic	D	D
	aM fuse	2 A	1.25 A
250	Breaker capacity	3 A	2 A
	Trip characteristic	D	D
320	aM fuse	2.5 A	1.6 A
	Breaker capacity	4 A	3 A
400	Trip characteristic	D	D
	aM fuse	3.15 A	2 A
630	Breaker capacity	5 A	3 A
	Trip characteristic	D	D
1000	aM fuse	4 A	2.5 A
	Breaker capacity	8 A	5 A
1600	Trip characteristic	D	D
	aM fuse	6.3 A	4 A
2000	Breaker capacity	13 A	8 A
	Trip characteristic	D	D
2500	aM fuse	10 A	6 A
	Breaker capacity	20 A	13 A
2500	Trip characteristic	D	D
	aM fuse	16 A	10 A
2500	Breaker capacity	32 A	20 A
	Trip characteristic	D	D
2500	aM fuse	20 A	12 A
	Breaker capacity	40 A	25 A
2500	Trip characteristic	D	D
	aM fuse	25 A	16 A
2500	Breaker capacity	50 A	32 A
	Trip characteristic	D	D

Notes:
 - The protection specified in the table is the minimum "recommended" for protecting the supply line.
 - The breaking capacity of the primary miniature circuit breakers is a function of the supply line.

Protection on secondary

The secondary circuit must be protected against overload and short-circuit. Moreover, additional protection may need to be adopted depending on the distribution system type.

- Overload: The tripping current value of the protection used should be equal to or lower than the secondary current of the transformer.
- Short-circuit: Any short-circuit in the most distant point of the line should make the protection device trip in less than 5 seconds (IEC 60364). The protection of the transformer and the protection of the line may coincide when the transformer supplies power to a single line and a full compatibility has been ensured. The suitable secondary protection can be found on the selection tables.

Power draw according to temperature and altitude

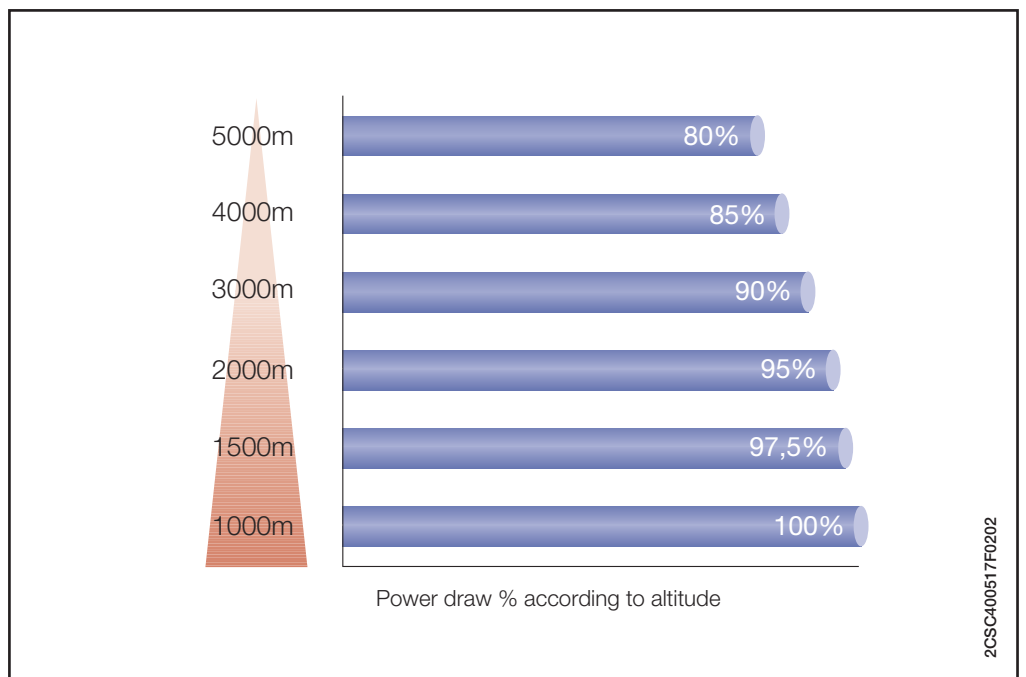
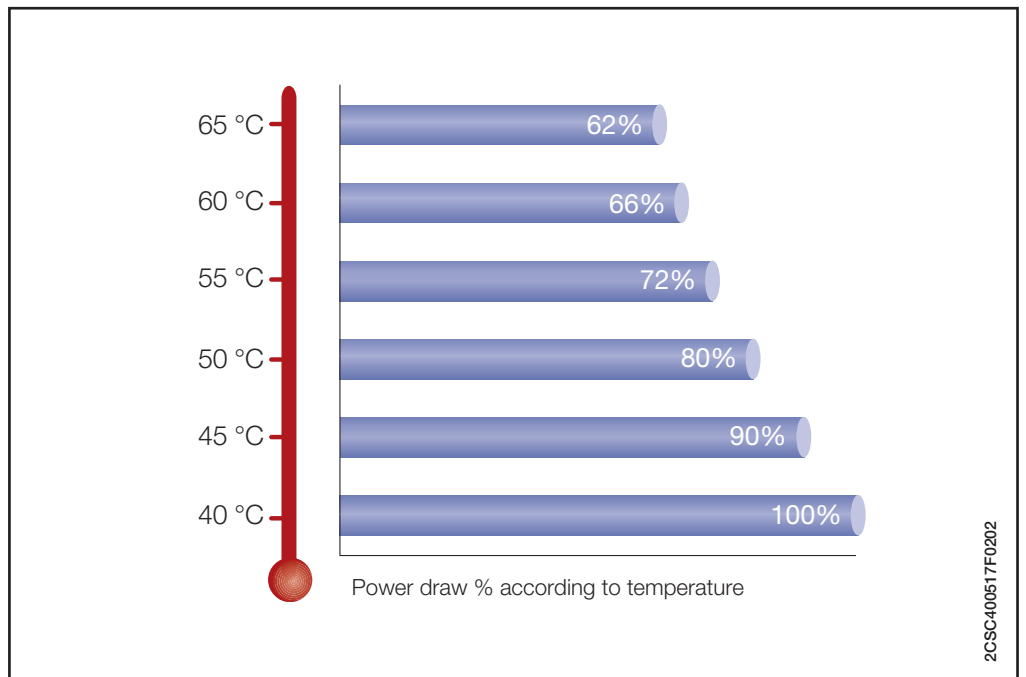

Short circuit voltage, no-load output voltage variations and power loss data

Power (VA)	50	100	160	200	250	320	400	630	1000	1600	2000	2500
Vcc ① (%)	10.6	7.5	5.2	4.8	9.5	6.9	6	4	3.5	3	2.8	2.3
ΔV ② (%)	11	7.8	6	5.8	6.7	7	5.4	4.3	3.3	2.8	2	1.8
Losses (W)	9	15	19	21	38	36	41	47	60	70	85	100

① Percent of rated supply voltage; ② Percent of rated output voltage

Inrush power trend

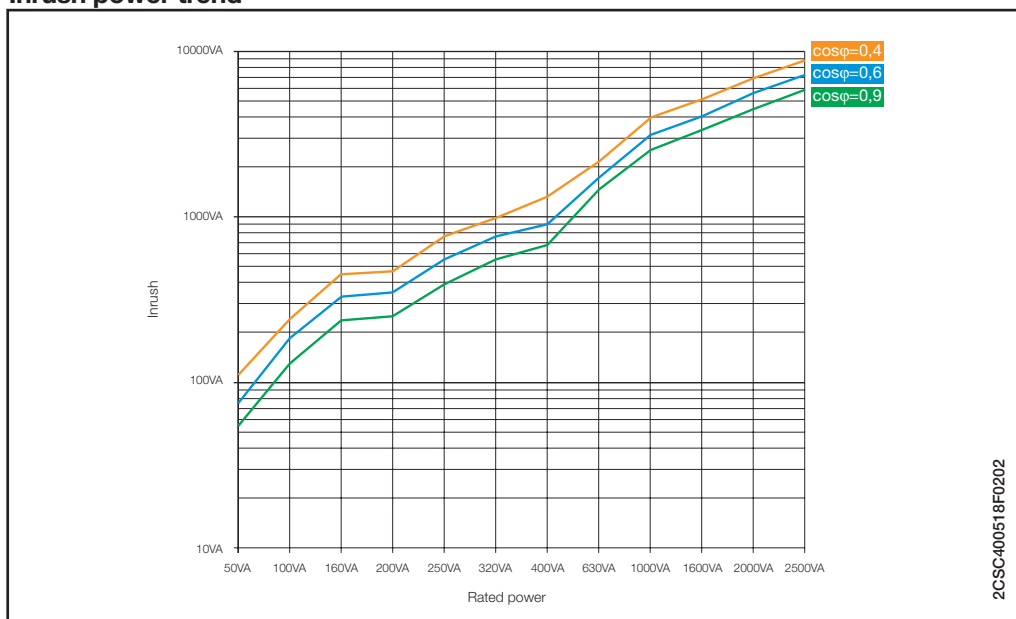

2CSC400518F0202

Admissible overload

If the transformer rated power is not drawn on a continuous basis, the transformer may be overloaded, according to the diagram below:

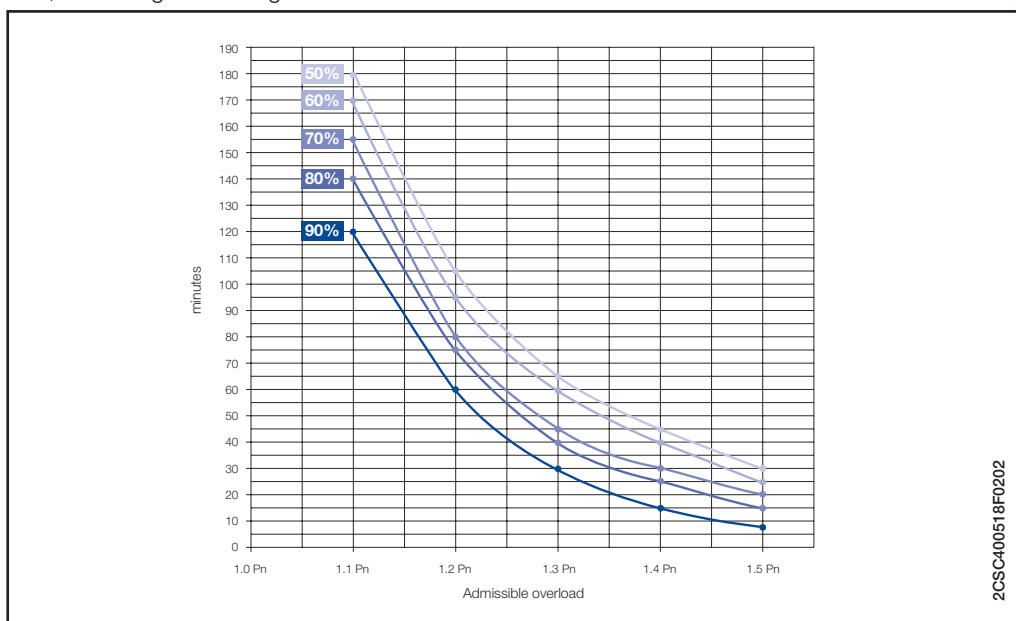

2CSC400518F0202

If a transformer is used with an intermittent duty cycle, it can be sized according to the formula:

$$P_{\text{transformer}} = P_{\text{intermittent}} * \sqrt{\frac{\text{operating time}}{\text{total cycle time (operating + pause time)}}}$$

with time expressed in minutes

In control equipment, can I use the two secondary outputs of a single transformer to supply two different auxiliary circuits?

It is possible to simultaneously use both the secondary outputs of an ABB transformer to supply two circuits with different voltage ratings. The sum of the power draw from each circuit must not exceed the power rating of the transformer.

What type of transformer should be used to supply safety extra low voltage (SELV) circuits?

To construct a SELV circuit it is necessary to use a safety transformer compliant with the IEC EN 61558-2-6 standard, which guarantees both electrical separation of the systems by means of double insulation and the required extra low voltage (12-24 V±5%).

Can the secondary windings of two or more ABB single-phase transformers be connected in parallel?

It is possible to connect in parallel up to a maximum of 3 ABB transformers of equal power, bearing in mind that the total power which can be drawn will be equal to 90% of the sum of the individual powers. Pay great attention to terminal connection and, if necessary, test the circuit first in series and then in parallel.

In a piece of equipment supplied at 24 V a.c., I need to supply a cooling fan with a voltage rating of 230 V a.c. Can I use a transformer, supplying it from the secondary?

It is possible to supply the transformers on the secondary side, but due to the nature of their construction, the voltage output from the primary may vary by 10-30% relative to the rated voltage.

How can I quickly size the power of a transformer?

$$P = 0.8 (\Sigma P_m + \Sigma P_r + P_a)$$

ΣP_m = Sum of all continuous power consumptions of contactors

ΣP_r = Sum of all the resistive powers

P_a = Inrush power of the largest contactor



2CSC400759F0001

MODULAR SOCKETS

This table gives an indication of the voltage, frequency and modular socket solutions in each country. Please consider that installation rules may change in each country, and control the local regulations before installing.

Country	Volt.		Freq.		Modular sockets						
	110-130 V	220-250 V	50 Hz	60 Hz	M1163	M1170	M1173	M1174	M1175	M1176	M2071
Afghanistan		■	■			■	■	■	■		
Albania		■	■			■	■	■	■		
Algeria	■	■	■			■	■	■	■		
American Samoa	■	■		■		■	■	■	■	■	
Andorra		■	■			■	■	■	■		
Angola		■	■			■	■	■	■		
Argentina		■	■			■	■	■	■		■
Armenia		■	■			■	■	■	■		
Aruba	■	■		■		■	■	■	■		
Australia		■	■							■	
Austria		■	■			■	■	■	■		
Azerbaijan		■	■			■	■	■	■		
Azores		■	■			■	■	■	■		
Bahrain		■	■		■						
Balearic Islands		■	■			■	■	■	■		
Bangladesh		■	■		■	■	■	■	■		
Belarus		■	■			■	■	■	■		
Belgium		■	■			■	■	■	■		
Belize	■	■		■							
Benin		■	■						■		
Bhutan		■	■		■	■	■	■	■		
Bolivia	■	■	■			■	■	■	■		
Bosnia & Herzegovina		■	■			■	■	■	■		
Botswana		■	■		■						
Brazil	■	■		■		■	■	■	■		
Brunei		■	■		■						
Bulgaria		■	■			■	■	■	■		
Burkina Faso		■	■			■	■	■	■		
Burundi		■	■			■	■	■	■		
Cambodia		■	■		■	■	■	■	■		
Cameroon		■	■			■	■	■	■		
Canary Islands		■	■			■	■	■	■		
Cape Verde		■	■			■	■	■	■		
Central African Republic		■	■			■	■	■	■		
Chad		■	■			■	■	■	■		
Channel Islands		■	■		■						
Chile		■	■			■	■	■	■		
Comoros		■	■			■	■	■	■		
Congo Dem.Rep.(Zaire)		■	■			■	■	■	■		
Congo, People's Rep. of		■	■			■	■	■	■		
Cook Islands		■	■							■	
Croatia		■	■			■	■	■	■		
Cuba	■	■		■		■	■	■	■		
Cyprus		■	■		■	■	■	■	■		
Czech Republic		■	■					■			

Country	Volt.		Freq.		Modular sockets						
	110-130 V	220-250 V	50 Hz	60 Hz	M1163	M1170	M1173	M1174	M1175	M1176	M2071
Denmark		■	■			■	■	■	■		
Djibouti		■	■			■	■	■	■		
Dominica		■	■		■						
East Timor		■	■			■	■	■	■	■	
Egypt		■	■			■	■	■	■		
Equatorial Guinea		■	■			■	■	■	■		
Eritrea		■	■			■	■	■	■		
Estonia		■	■			■	■	■	■		
Ethiopia		■	■			■	■	■	■		
Faeroe Islands		■	■			■	■	■	■		
Falkland Islands		■	■		■						
Fiji		■	■							■	
Finland		■	■			■	■	■	■		
France		■	■					■			
French Guyana	■	■	■			■	■	■	■		
Gabon		■	■			■	■	■	■		
Gambia		■	■		■						
Georgia		■	■			■	■	■	■		
Germany		■	■			■	■	■	■		
Ghana		■	■		■						
Gibraltar		■	■		■	■	■	■	■		
Greece		■	■			■	■	■	■		
Greenland		■	■			■	■	■	■		
Grenada		■	■		■						
Guadeloupe		■	■			■	■	■	■		
Guatemala	■	■		■						■	
Guinea		■	■			■	■	■	■		
Guinea-Bissau		■	■			■	■	■	■		
Guyana		■		■	■						
Hong Kong		■	■		■						
Hungary		■	■			■	■	■	■		
Iceland		■	■			■	■	■	■		
India		■	■			■	■	■	■		
Indonesia	■	■	■		■	■	■	■	■		
Iran		■	■			■	■	■	■		
Iraq		■	■			■	■	■	■		
Ireland		■	■		■						
Isle of Man		■	■		■	■	■	■	■		
Israel		■	■			■	■	■	■		
Italy		■	■			■	■	■	■		
Ivory Coast		■	■			■	■	■	■		
Jordan		■	■		■	■	■	■	■		
Kazakhstan		■	■			■	■	■	■		
Kenya		■	■		■						
Kiribati		■	■							■	

Main countries are highlighted

Country	Volt.		Freq.		Modular sockets						
	110-130 V	220-250 V	50 Hz	60 Hz	M1163	M1170	M1173	M1174	M1175	M1176	M2071
Korea, North											
Korea, South	■	■		■		■	■	■	■		
Kuwait		■	■		■	■	■	■	■		
Kyrgyzstan		■	■			■	■	■	■		
Laos		■	■			■	■	■	■		
Latvia		■	■			■	■	■	■		
Lebanon	■	■	■		■	■	■	■	■		
Lithuania		■	■			■	■	■	■		
Luxembourg		■	■			■	■	■	■		
Macau		■	■		■						
Macedonia		■	■			■	■	■	■		
Madagascar	■	■	■			■	■	■	■		
Madeira		■	■			■	■	■	■		
Malawi		■	■		■						
Malaysia		■	■		■						
Maldives	■	■	■		■	■	■	■	■		
Mali		■	■			■	■	■	■		
Malta		■	■		■						
Martinique		■	■			■	■	■	■		
Mauritania		■	■			■	■	■	■		
Mauritius		■	■		■	■	■	■	■		
Moldova		■	■			■	■	■	■		
Monaco		■	■			■	■	■	■		
Mongolia		■	■			■	■	■	■		
Montenegro		■	■			■	■	■	■		
Morocco	■	■	■			■	■	■	■		
Mozambique		■	■			■	■	■	■		
Myanmar(form. Burma)		■	■			■	■	■	■		
Nauru		■	■							■	
Nepal		■	■			■	■	■	■		
Netherlands		■	■			■	■	■	■		
Netherlands Antilles	■	■	■	■		■	■	■	■		
New Caledonia		■	■			■	■	■	■		
New Zealand		■	■							■	
Niger		■	■			■	■	■	■		
Nigeria		■	■		■						
Norway		■	■			■	■	■	■		
Oman		■	■		■						
Pakistan		■	■			■	■	■	■		
Papua New Guinea		■	■							■	
Paraguay		■	■			■	■	■	■		
Peru		■	■	■		■	■	■	■		
Philippines		■	■	■		■	■	■	■		
Poland		■	■			■	■	■	■		
Portugal		■	■			■	■	■	■		
Qatar		■	■		■						
Réunion Island		■	■					■			

Main countries are highlighted

Country	Volt.		Freq.		Modular sockets						
	110-130 V	220-250 V	50 Hz	60 Hz	M1163	M1170	M1173	M1174	M1175	M1176	M2071
Romania		■	■				■	■	■	■	
Russian Federation		■	■			■	■	■	■		
Rwanda		■	■			■	■	■	■		
Samoa		■	■							■	
San Marino		■	■			■	■	■	■		
Saudi Arabia	■	■		■	■	■	■	■	■		
Senegal		■	■			■	■	■	■		
Serbia		■	■			■	■	■	■		
Seychelles		■	■			■					
Sierra Leone		■	■		■						
Singapore		■	■		■						
Slovakia		■	■					■			
Slovenia		■	■			■	■	■	■		
Somalia	■	■	■			■	■	■	■		
Spain		■	■			■	■	■	■		
Sri Lanka		■	■		■						
St. Kitts and Nevis		■		■	■						
St. Lucia		■	■		■						
St. Vincent		■	■		■	■	■	■	■	■	
Sudan		■	■			■	■	■	■		
Suriname	■	■		■	■	■	■	■	■		
Sweden		■	■			■	■	■	■		
Syria		■	■			■	■	■	■		
Tahiti	■	■		■	■	■	■	■	■		
Tajikistan		■	■			■	■	■	■		
Tanzania		■	■		■						
Thailand		■	■			■	■	■	■		
Togo		■	■			■	■	■	■		
Tonga		■	■							■	
Tunisia		■	■			■	■	■	■		
Turkey		■	■			■	■	■	■		
Turkmenistan		■	■			■	■	■	■		
Uganda		■	■		■						
Ukraine		■	■			■	■	■	■		
United Arab Emirates		■	■		■						
United Kingdom		■	■		■						
Uruguay		■	■			■	■	■	■		
Uzbekistan		■	■			■	■	■	■		
Vietnam	■	■	■		■	■	■	■	■		
Yemen, Rep. of		■	■		■						
Zambia		■	■		■	■	■	■	■		
Zimbabwe		■	■		■						

Index

MRDCs

DDA AE emergency stop.....	12/4
OVR Surge Protective Devices.....	12/5
ISOLTESTER-DIG-PLUS insulation monitors	12/6
ISL insulation monitors	12/7
E 259 installation relays.....	12/8
E 255 latching relays with sequential contacts	12/9
E 257 latching relays with central command	12/10
E 257 C10 electronic latching relays	12/11
AT electro-mechanical time switches.....	12/12
D Line digital time switches	12/13
DTS yearly digital time switches	12/14
E 232 staircase relays	12/15
TW1 twilight switches	12/16
TWP twilight switches for pole mounting	12/17
TWA-1/TWA-2 astronomical twilight switches	12/18
THS modular thermostats	12/19
ATT-22 GSM terminal	12/20
ATT-81 GSM terminal	12/21
RAL overload alarms.....	12/22
LSS1/2 load shedding switches.....	12/23
SQZ3 phase and sequence relays	12/24
DMTME multimeter.....	12/25
DMTME-96 multimeter	12/26
ANR network analyser.....	12/27
M1173-L-R red modular socket with indicator light.....	12/28
M1175-FL modular socket with fuse.....	12/29
MeMo USB modular storage device.....	12/30

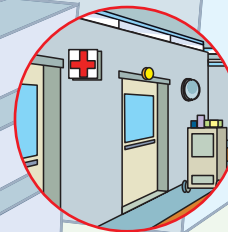
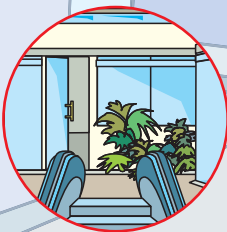
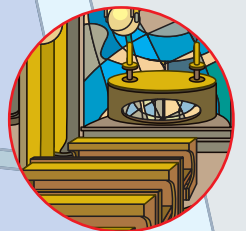
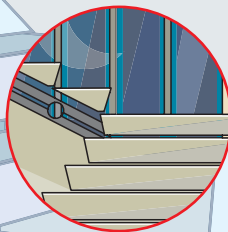
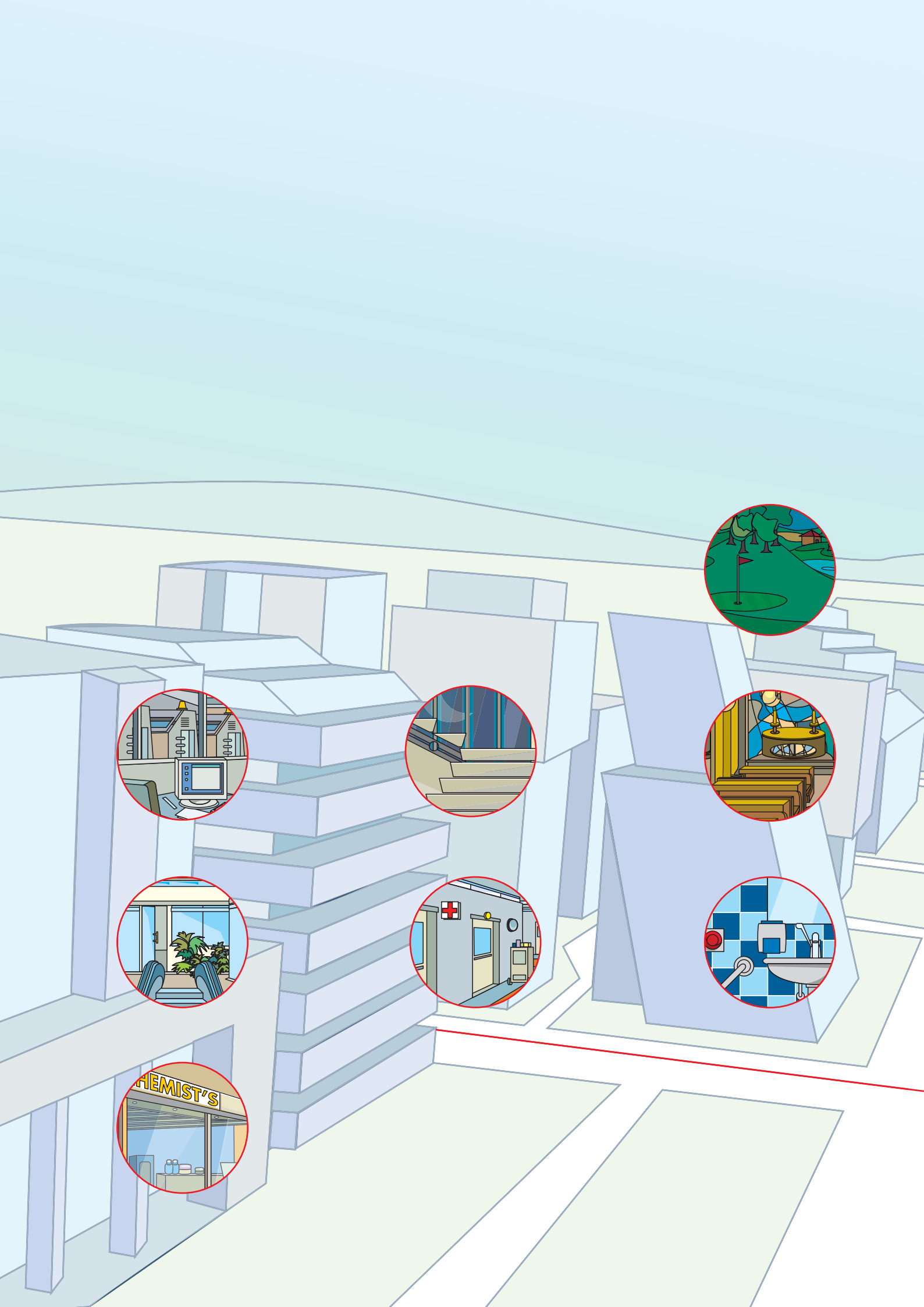

Examples of applications

Residential buildings

Public buildings

Commercial buildings

Industry

Handicraft

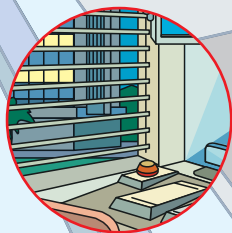
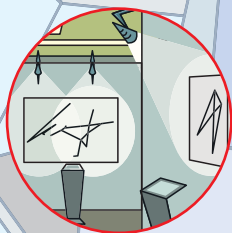
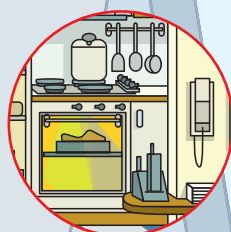
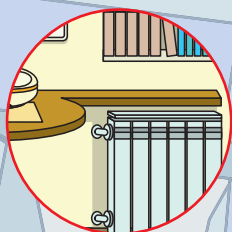

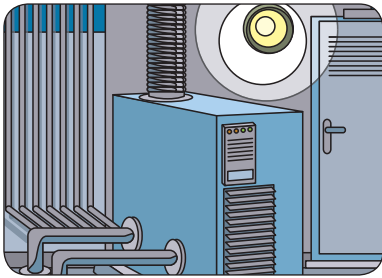

2CSC400801F0202

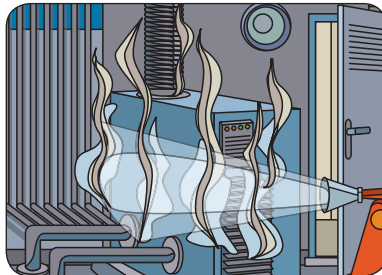
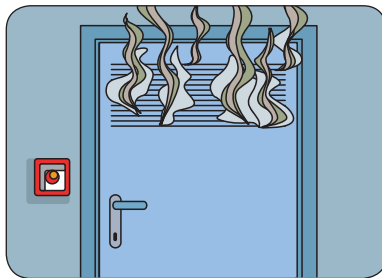
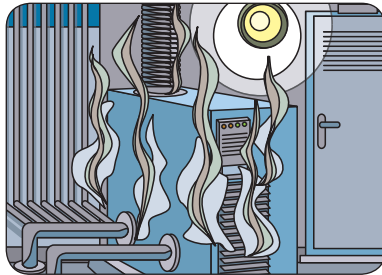

Operating principle

The blocks are provided with two terminals that make it possible to insert, into one of the additional windings, one or more NC emergency buttons to remotely command opening of the breaker.

Interrupting the current in the circuit of the additional winding by means of the emergency button will thus provoke the differential release of the breaker associated with the block.

The DDA AE blocks clearly guarantee positive safety of the emergency function, since any accidental interruption of the circuit will cause the breaker to open as if the emergency button had been pressed.

However, unlike an undervoltage release (the device normally used to implement this type of function), the breaker will not open if there is a loss of voltage on the line, for example following a black-out caused by a storm.

Application environments

The DDA AE blocks offer the conventional residual-current protection function, with the added possibility of constructing release circuits that are positively safe.

They are suitable for protecting machinery, handling equipment, and in general for all installations where this type of solution is recommended.

Example of installation

The figures show an example application in which an emergency button is installed outside a heating plant room, and connected to the differential circuit of the DDA AE block which allows the interruption of the electricity supply.

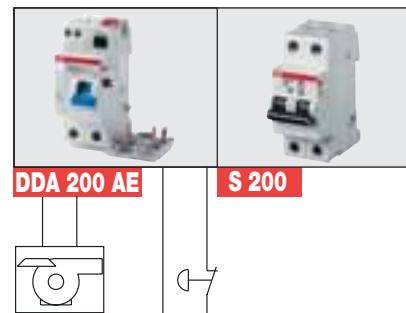

2CSC400801F0202

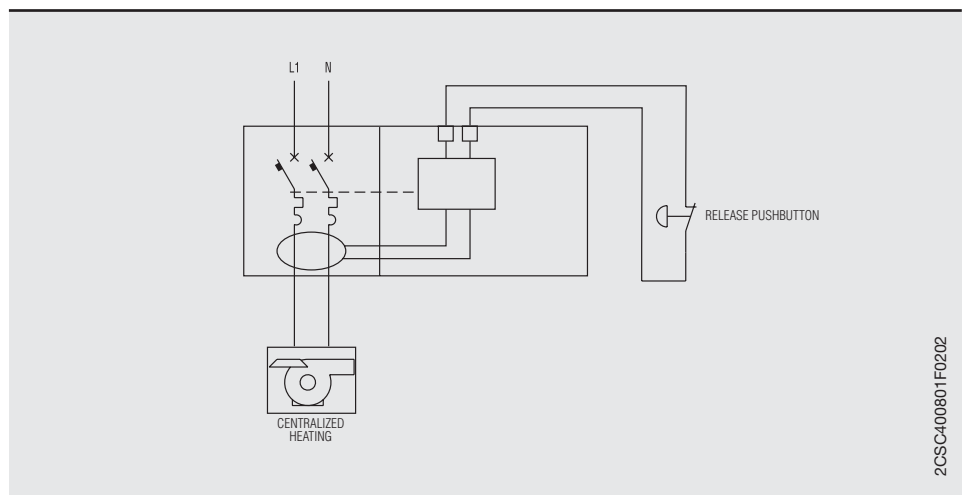

2CSC400801F0202

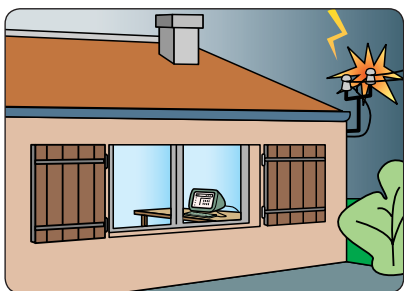

2CSC400802F0202

Operating principle

The Surge Protective Devices (SPDs), suitable for residential, commercial and industrial applications, are designed to limit transient overvoltage and run-off lightning currents.

Application environments

Application environments
The Surge Protective Devices (SPDs) are necessary in any environment where the lightning risk exists (direct lightning strike or overvoltages may occur).

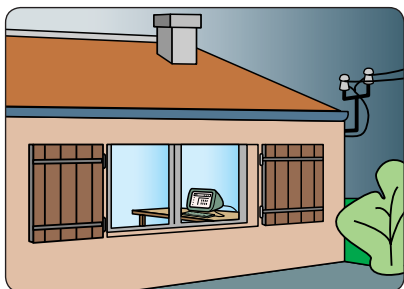
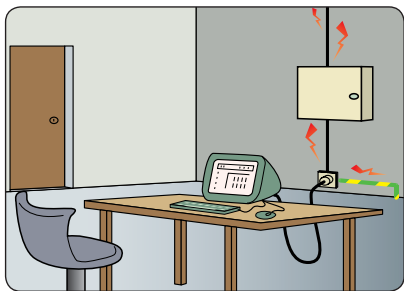

Example of installation

As shown in the diagrams, one of the possible applications is to protect the equipment (TV, computer, ...) against overvoltage thanks to a Surge Protective Device (SPD) which ensures the protective in common mode (Ph-PE / N-PE) and differential mode (Ph-N).

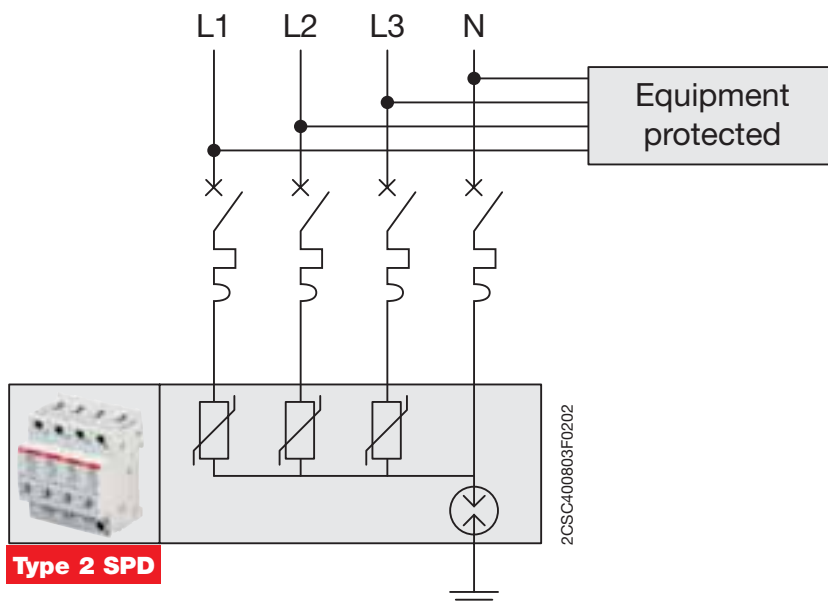

**ISOLTESTER-DIG-PLUS Insulation
monitoring device**



2CSC400804F0202

Operating principle

ISOLTESTER-DIG-PLUS uses an encoding measuring signal that guarantees reliable measurements even in the presence of strong harmonic distortions.

Application environments

Thanks to the fact that it prevents nuisance tripping, ISOLTESTER-DIG-PLUS is ideal for all group 2 medical locations that need high operational continuity.

Without ISOLTESTER-DIG-PLUS

With ISOLTESTER-DIG-PLUS



Example of installation

Conventional CRT or LCD displays, portable oxygen delivery systems, X-ray and sterilizing equipment can all provoke network disturbances.

Unlike conventional insulation monitoring devices ISOLTESTER-DIG-PLUS uses an encoded measuring signal that is not affected by network disturbances

The medical staff are thus able to continue working as normal, without any interruptions due to nuisance tripping.

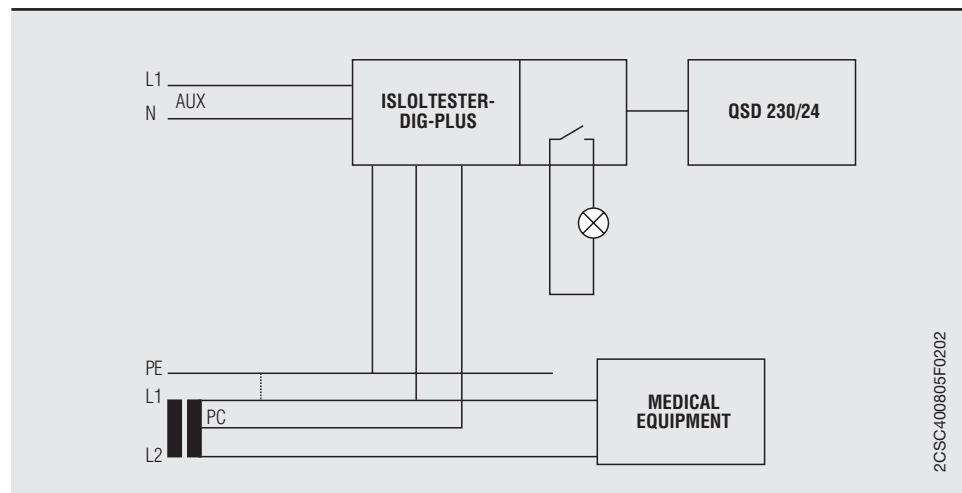

2CSC400805F0202

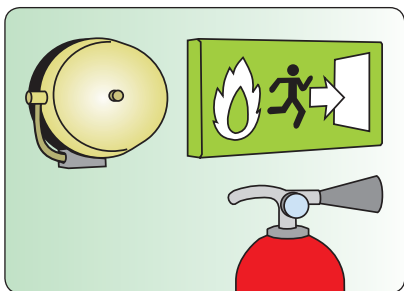

2CSC400807F0202

Operating principle

In IT electrical distribution systems that supply critical applications, where operational continuity is essential, ISL insulation monitoring devices assure continuous surveillance to promptly detect any insulation loss.

Application environments

All IT distribution systems in which operational continuity is a critical factor, and in particular:

- 24-28 V, 100-144 V and 220 V d.c. networks
- 24-48 V, 100-144 V and 380-415 V a.c. networks
- 20-700 V a.c./d.c. voltageless networks

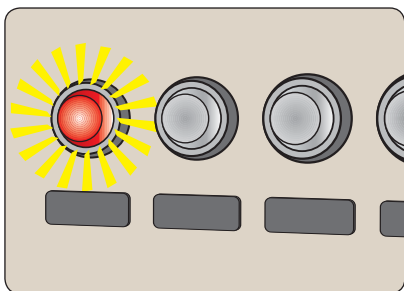
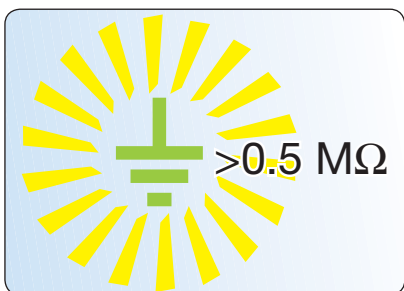
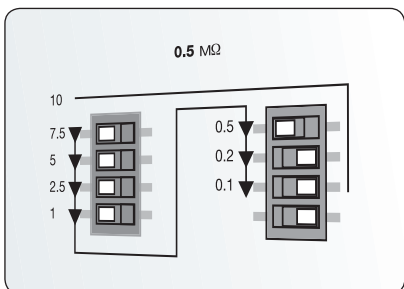

Example of installation

ISL-MOT 1000 is suitable for preventive protection of voltageless circuits such as alarm and fire-fighting systems, pumps, etc. ISL-MOT 1000 continually monitors the insulation level between the line and earth, to guarantee that the system will function correctly when needed.

The trip threshold is programmable, and insulation loss can be signalled via a change-over contact, which can also be used for switching loads.

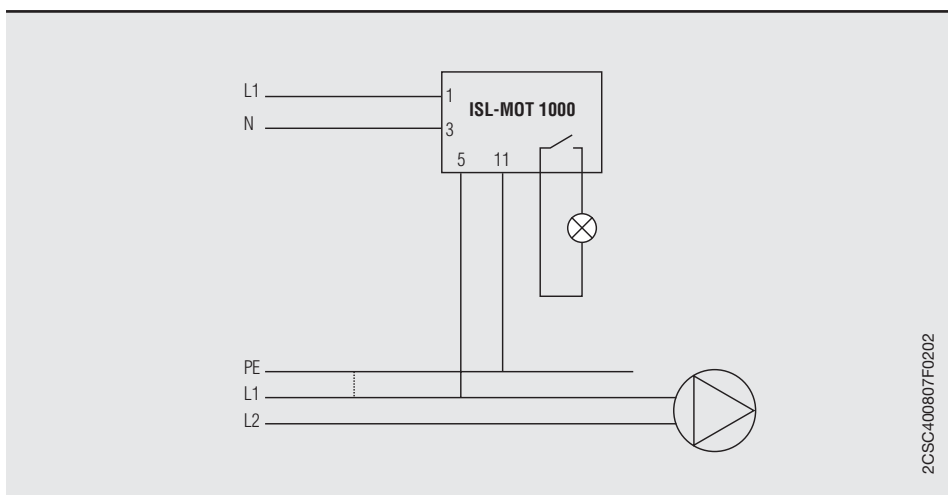

2CSC400807F0202

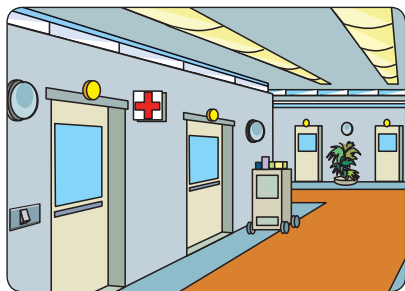

2CSC400808F0202

Operating principle

The E 259 installation relays are 16 A contactors specifically engineered for residential and commercial applications and are available in a wide range of contact layouts and coil voltages.

Application environments

The E 259 installation relays are particularly indicated in residential and commercial buildings for lighting control.

Example of installation

As shown in the diagrams, one of the possible applications is to mount the E 259 16-11 installation relay with a NO and a NC contact inside the electric system of a hospital ward. The first control sent through a switch to the command circuit of the relay will turn off the ceiling lights and turn on the corridor lamps, while the second command returns to the previous state.

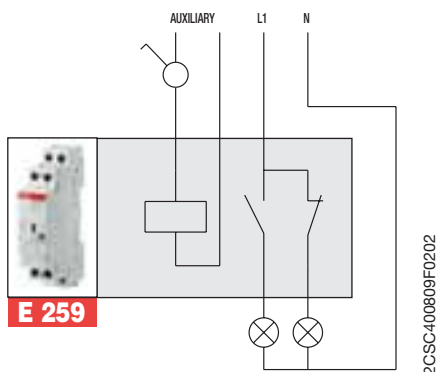
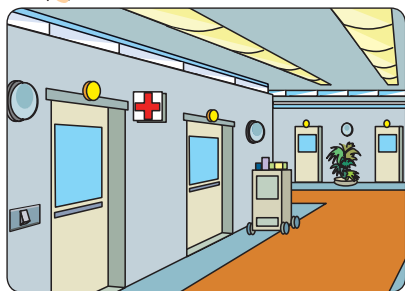
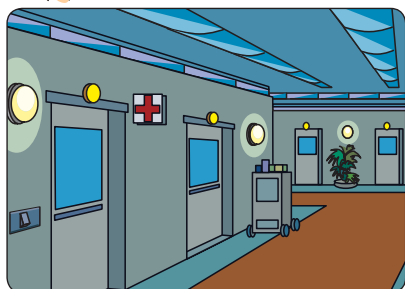

2CSC400809F0202

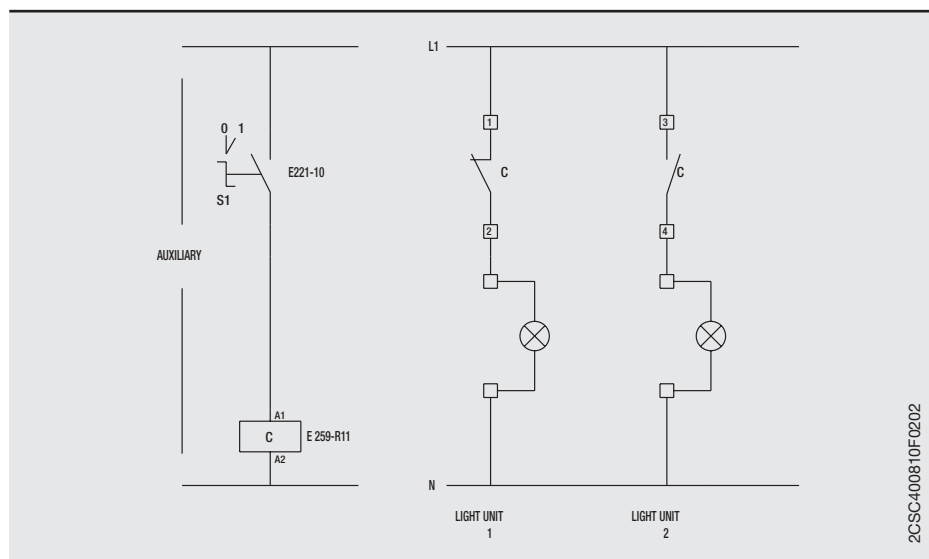

2CSC400810F0202

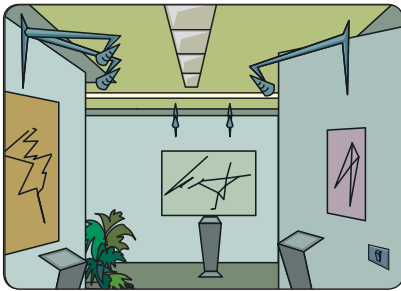

2CSC400811F0202

Operating principle

The two contacts of the E 255 latching relays switch independently their position (open/closed) at each impulse according to a preset sequence in the control circuit.

Application environments

The E 255 latching relays are particularly indicated in environments and situations requiring the load sequential control through a single pushbutton circuit (offices, restaurants, etc.).

Example of installation

As shown in the diagrams, one of the possible applications is to mount the E 255 latching relays inside the lighting system of an art gallery. The first pushbutton impulse will switch on the ceiling lights, the second triggers the wall lamps, the third switches off the ceiling lights and the fourth switches off the wall lamps.

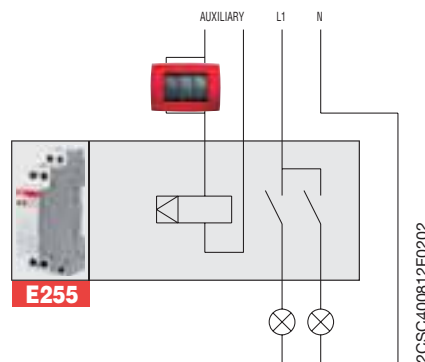
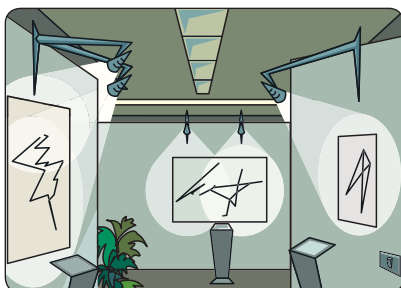
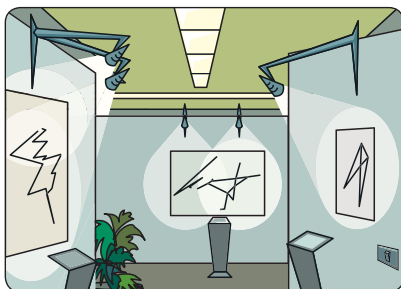
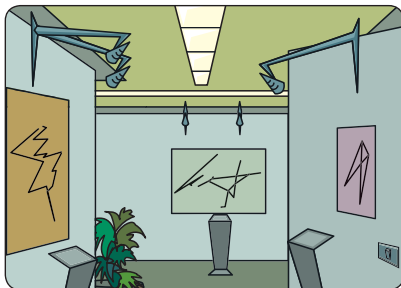

2CSC400812F0202

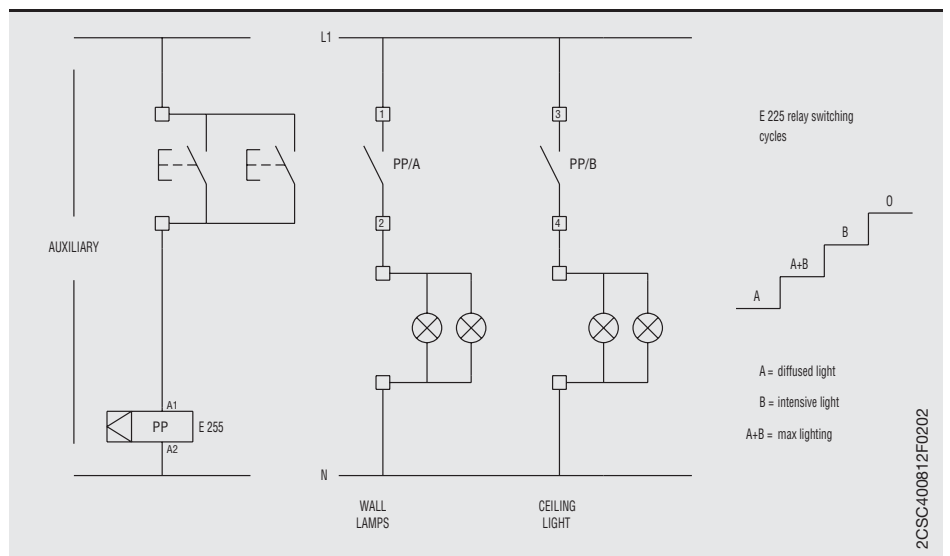

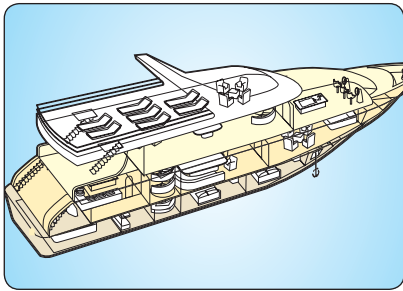

2CSC400813F0202

Operating principle

The E257 relays have a central command that allows the contacts of all the relays to be brought to the same position by sending a pulse to the ON (or OFF) circuit.

Application environments

The E257 relays are suitable for applications in which loads (i.e. in a lighting circuit) are controlled through multiple relays, commanded both locally and through a central command for resetting all the relays.

Example of installation

As illustrated in the diagrams, the E257 relays (installed in the panel of a yacht) allow loads to be controlled from the main panel through pulses sent to the local coil of each E257.

In the event of an accidental reset of the main control panel, it will lose track of the individual state of the E257 relays. For this reason, the reboot procedure requires all the E257 relays to be reset to OFF.

The main control panel accomplishes this by sending a pulse to all the OFF contacts of the E257 relays, through a type E259 support relay, thus bringing all the relays to the same state.

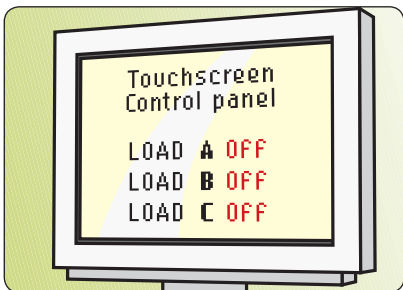
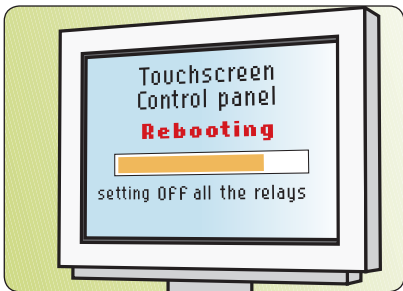
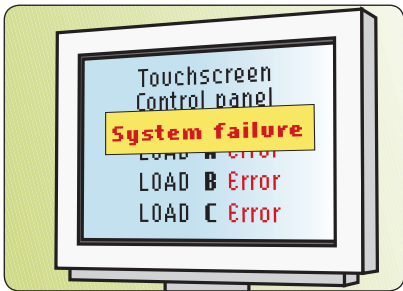
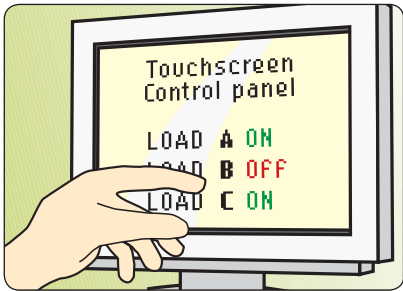

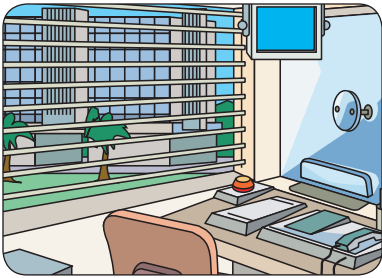

2CSC400814F0202

Operating principle

The E 257 latching relay is controlled by two circuits. The first is operated by a button and causes it to switch its contacts (open/closed). The second circuit instead changes the state of the relay's contacts to open or closed irrespective of their previous state.



Application environments

The E 257 latching relay with central command is particularly suited to those situations which require sending a single command to switch on/off multiple loads irrespective of the preceding open/closed state of their circuits (lighting circuits in office complexes, hotels, museums, theatres, etc).



2CSC400800F0202

Example of installation

As illustrated in the figures, one example application is to install the E 257 latching relay with central command in the electrical system of an office complex, in which the lights of individual offices can be turned on or off either from switches in the various rooms, or by operating on all the circuits simultaneously from the porter's lodge or other central location.

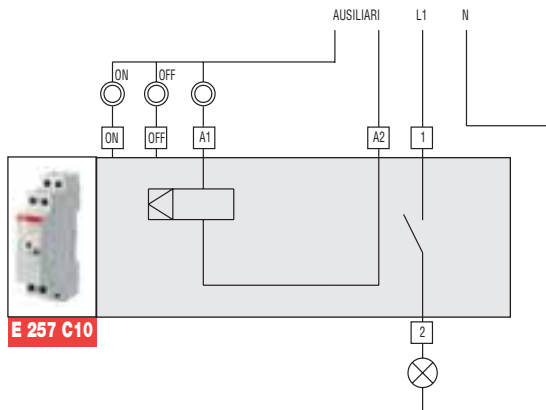

E 257 C10

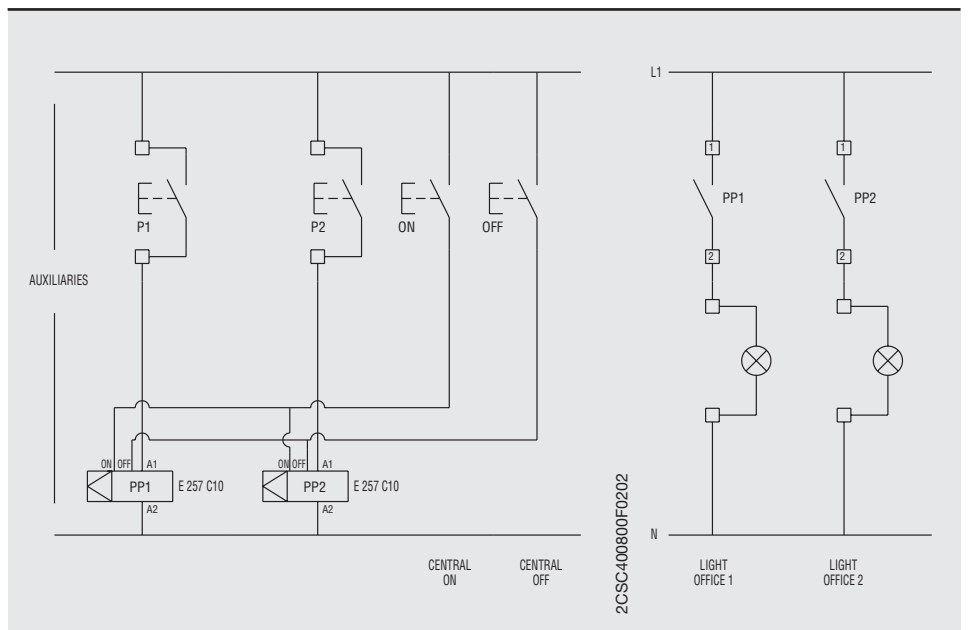

2CSC400800F0202



2CSC400816F0202

Operating principle

The AT electro-mechanical time switches enable to control the circuit opening/closing according to a daily or weekly program or to manually set permanent ON/OFF operation.

Application environments

The AT electro-mechanical time switches are particularly indicated in any environment and situation where it is necessary to program system load operation according to a daily or weekly frequency (shop lighting system, public buildings, heating systems, irrigation systems, etc.).

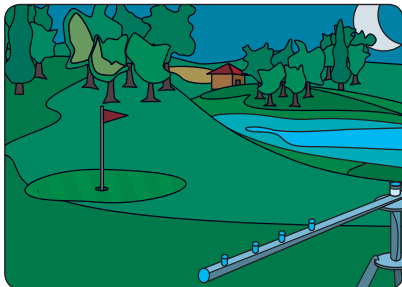
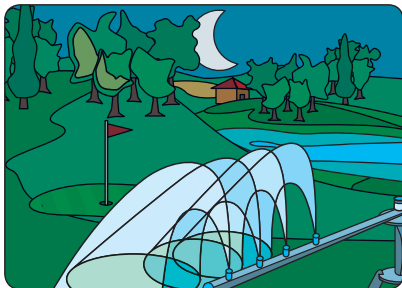

Example of installation

As shown in the diagrams, one of the possible applications is to mount the AT3-7R electro-mechanical time switch inside the power supply circuit of a golf field. In this case the device programming enables the daily activation of the irrigation system at a preset time

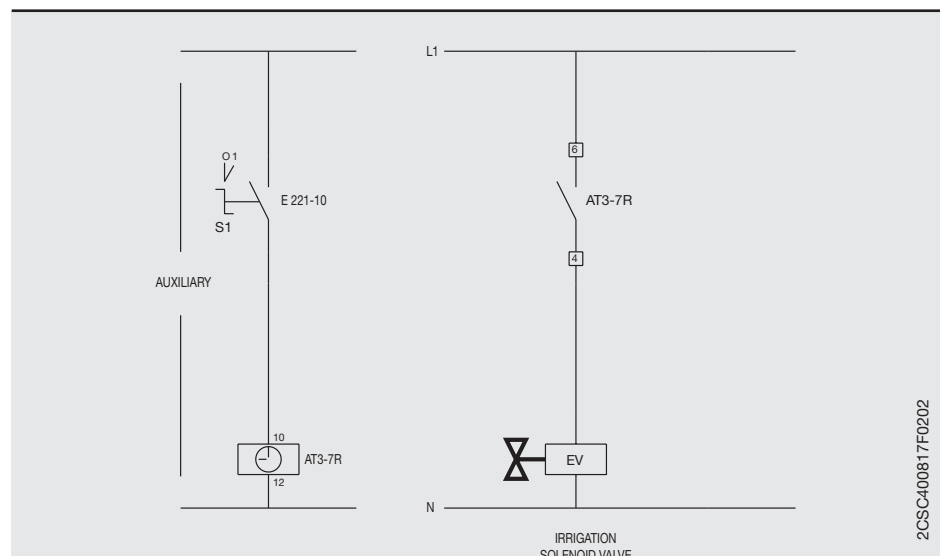
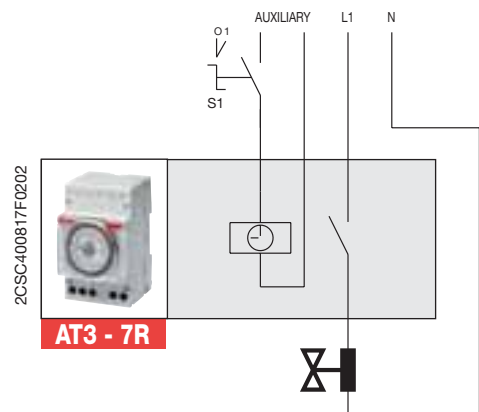

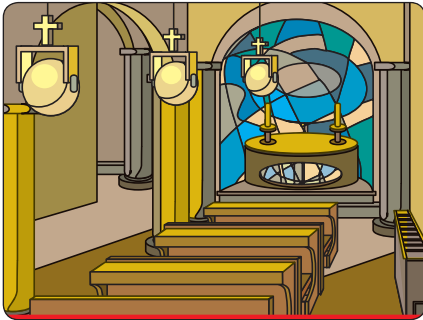

2CSC400800F0202

Operating principle

The D2 two-channel digital time switches enable to open and close circuits according to a daily or weekly program, controlling single loads or group of loads even when they require different time controls with a common time reference.

In this example, the digital time switch D2 allows the operation of heating as well as lighting systems of a church when services are performed; when no service is performed, the device only controls the heating system.

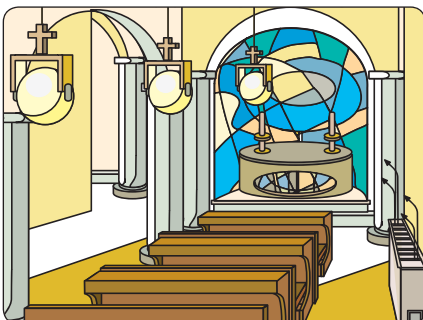
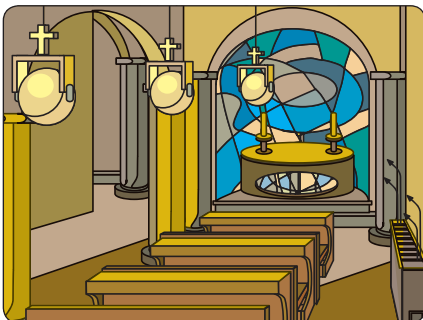

Application environments

The D2 two-channel digital time switches are particularly indicated in environments and situations requiring the management of multiple loads according to a time program flexible enough to include or exclude their application based on the day of the week (offices, schools, public areas, etc.).

Example of installation

As shown in the diagrams, one of the possible applications is to mount the D2 two-channel digital time switch inside the power supply circuit of a church, where in the days when no service is performed only the heating system is activated (programmed on one of the two channels) at a preset time, while on Sundays and when services are performed the lighting system is also switched on (through a program on the second channel). According to the controlled system power, the activation is performed by an ESB contactor.

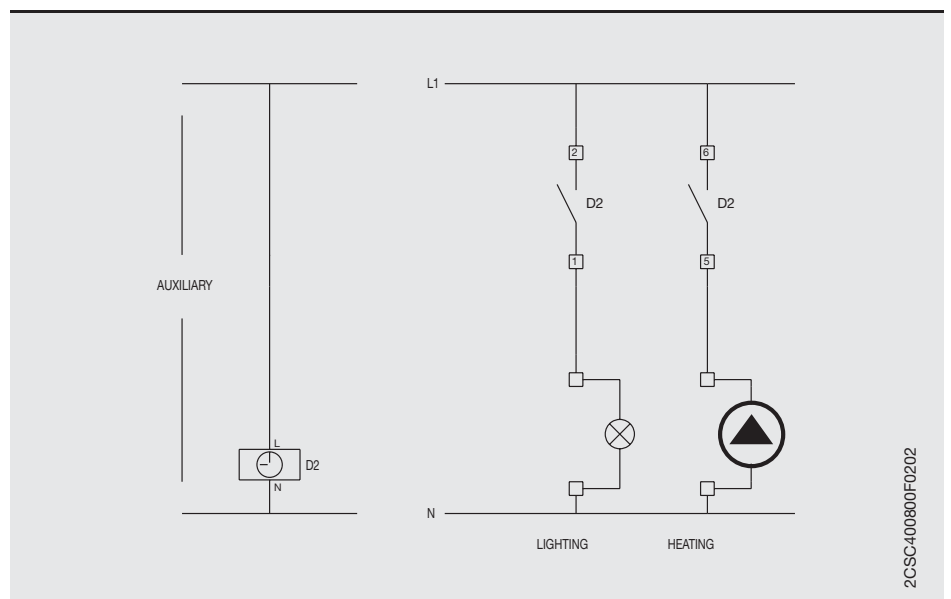
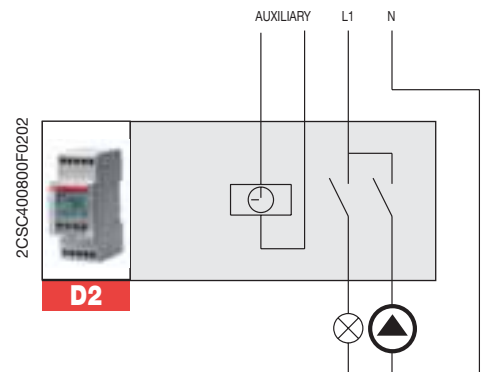



2CSC400818F0202



Operating principle

With annual digital timer switches you can automate one or more utilities according to even complex and articulated programs with daily, weekly, monthly and annual frequency. In addition to switching, programming includes impulsive controls, cyclical ON/OFF and even astronomical functions. Lighting, heating, sirens, escalators, etc.; everything starts at a precise and set hour under the constant control of the DTS model.

Application environments

The installation of a DTS annual digital timer switch is especially suited for schools, hospitals, train stations, airports, industrial factories, public buildings, malls, etc. where the perfect operations of all devices are required at a set time.

Example of installation

As shown in the diagrams, one of the possible applications is the installation of a DTS7/4Y 4-channel annual digital timer switch in a mall power circuit where lighting, heating and escalators run from morning till night on work days with the periodic activation of a siren at closing hours. The ample clock memory space allows you to automate the system for the entire year, setting all holidays when loads are left off and thus saving energy and avoiding the risks of error in reprogramming. Combination with a DTS/DCF antenna also allows you to keep the clock constantly synchronised with the precise time, avoiding any time changes.

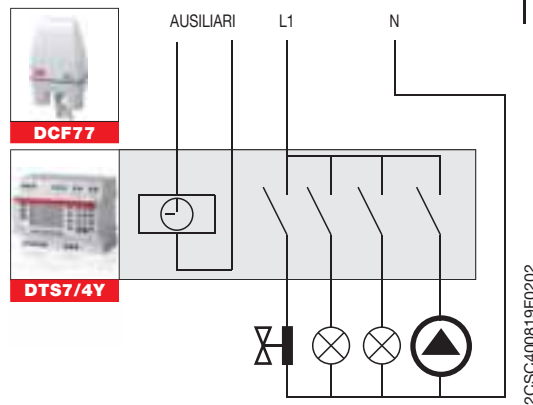

2CSC400819F0202

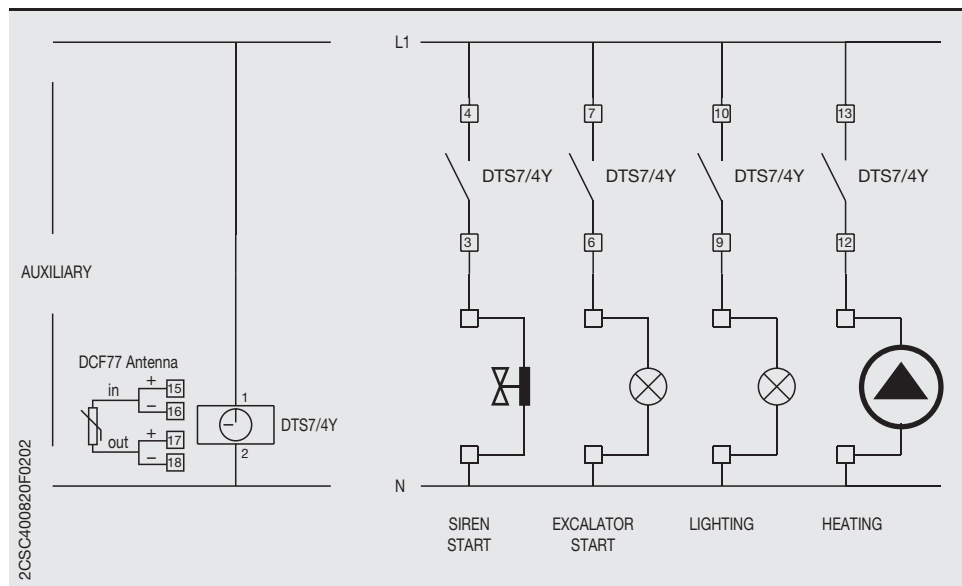

2CSC400820F0202

12



2CSC400821F0202

Operating principle

Activated by a pulse command of a push-button, the E 232 staircase switch turns on the plant's light for a T1 time that can be protracted, with a 50% dimming of the light intensity, by means of the parallel wiring of a HLM half-light module.

Application environments

Installation of E 232 staircase switch, coupled with the HLM half-light module, can be ideal wherever timing of the lighting is requested (staircase and pathways of public places, cellars, garage, etc.).

Example of installation

As illustrated, one among the possible applications concern installation of the E 232 staircase switch, coupled to a HLM half-light module, in the staircase lighting plant of a multistory building. Pushing the push-button, the timer of the E 232 switch turns on the lights for a settable T1 time. At the end of T1 time, the HLM half-light module dims the light by a 50% for a T2 time in the while is possible turn on again the full lighting.

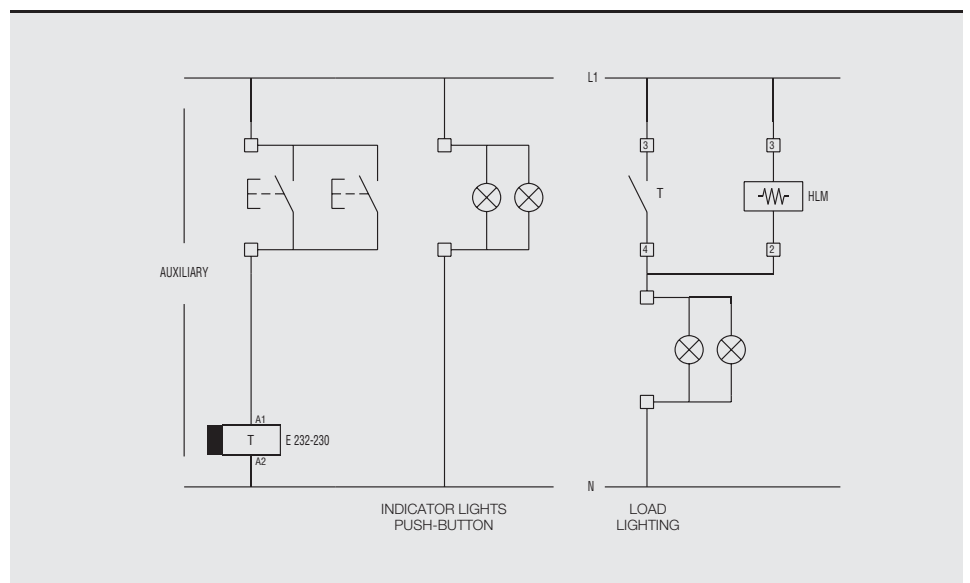
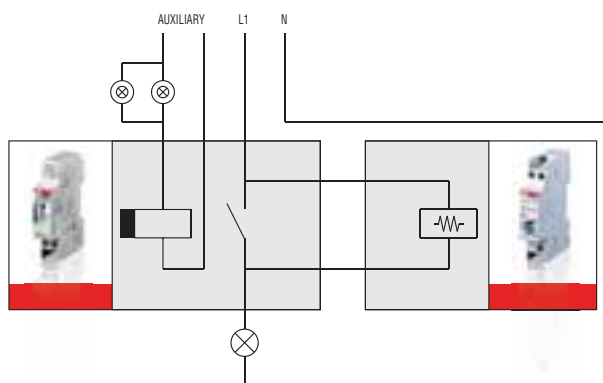



2CSC400823F0202



Operating principle

The diagram is an example of a TW1 twilight device installed in a mall lighting system. When outdoor light drops under a certain level (for example, in the evening store closing hours), the device turns on window and sign lights. Lights can be turned off during the night to rationalise consumption thanks to the AT1 timer switch.

Application environments

The installation of a TW1 twilight switch with AT electromechanical timer switch is especially suited for environments and situations in which energy consumption rationalisation is required (stores, office and public walkways, car parks, parks, etc.).

Example of installation

As shown in the diagrams, one of the possible applications consists in the installation of a TW1 twilight switch in a mall lighting system. When outdoor light drops under a certain level (for example, in the evening store closing hours), the twilight switch turns on window and sign lights. Lights can be turned off during the night thanks to the AT1 timer switch which keeps the circuit open until the next morning. When outdoor lighting returns over the limit, the twilight relay returns to the open position.

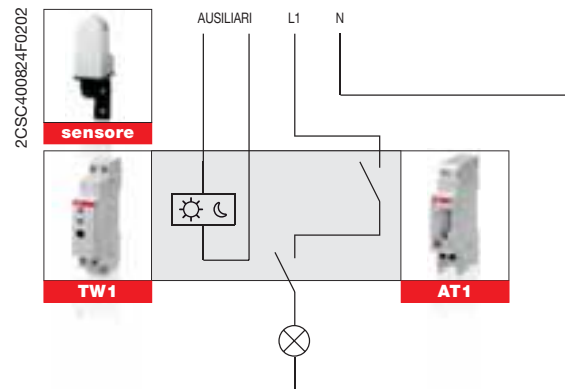

2CSC400824F0202

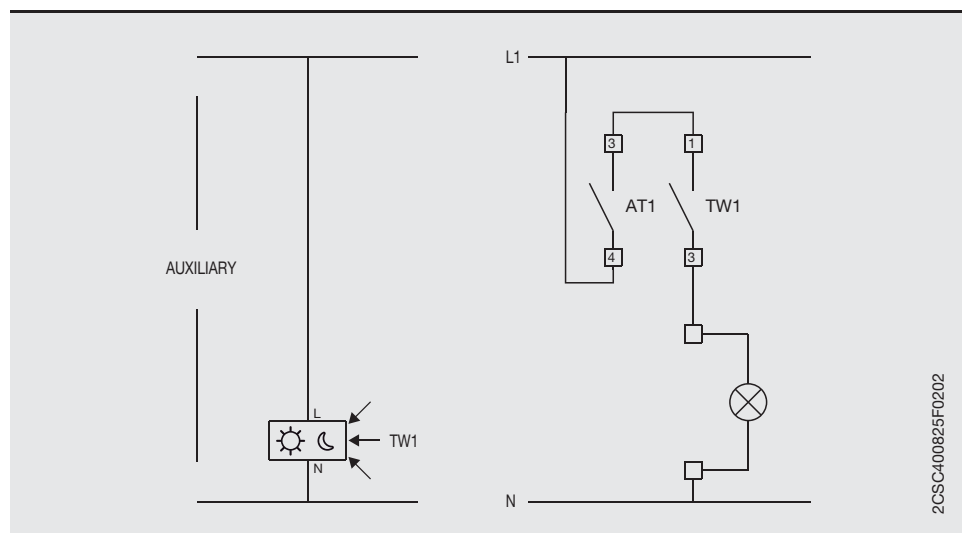

2CSC400825F0202



2CSC400826F0202

Operating principle

This diagram is an example of the installation of a pole mounting TWP twilight switch in a highways lighting plant. When the daylight dims below a set level, i.e. below 10 lux, the device turns on the lighting devices in tunnels, service areas, access road, etc. TWP will turn off the lights when morning daylight raise above 10 lux.

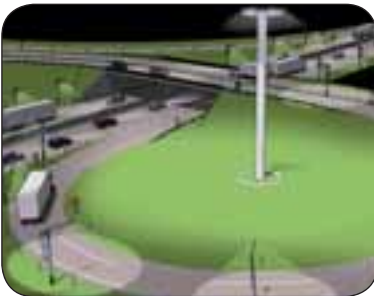

Application environments

The pole mounting TWP twilight switch installation can be ideal to light command in public roadways thanks to its capability of installation in pole, lamppost, etc.



Example of installation

As illustrated in the diagram, one among the possible applications concern the installation of a pole mounting TWP twilight switch in a highway lighting plant. When daylight dims below a set level (e.g. during twilight) the switch turns on the lighting devices, assuring the requested lighting. At dawn, when the light raise above the set threshold, the relays of TWP returns in open position.

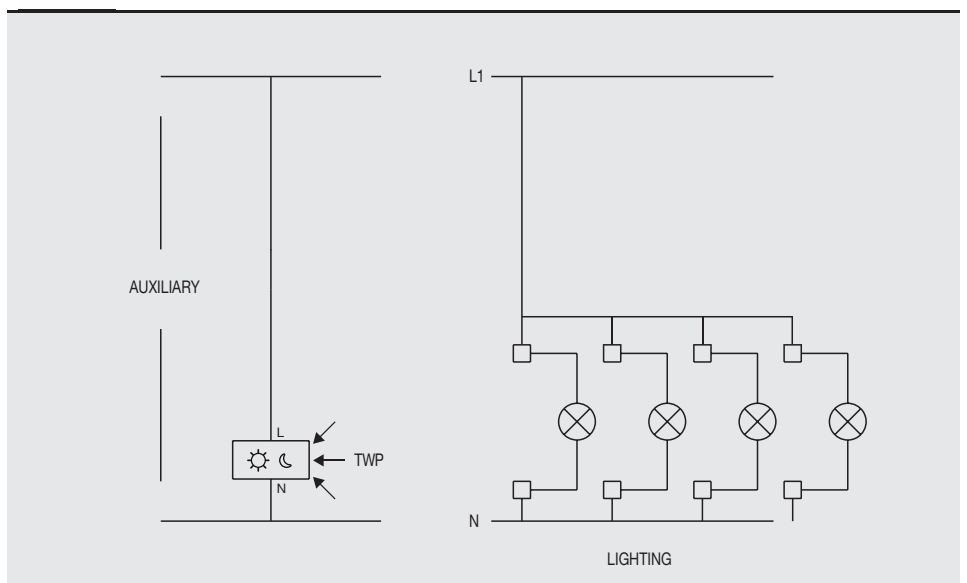
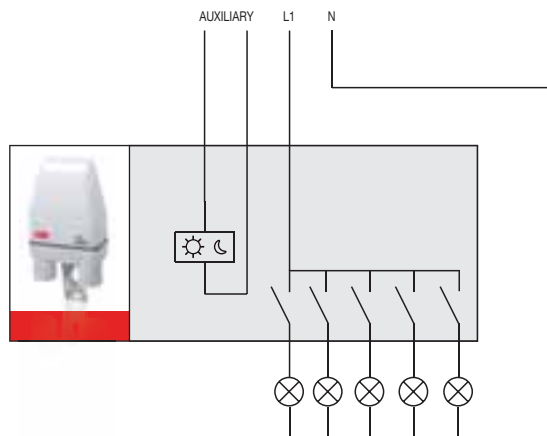



2CSC400828F0202

Operating principle

Installation of a twilight astronomical switch in a system is particularly useful in places and situations where light sources or other environmental conditions may cause changes in the Lux level.

In these cases, TWA-1 and TWA-2 enable control of the lighting system depending on the time when the sun rises and sets, based on the geographic location where they are installed.



Application environments

The TWA-1 and TWA-2 twilight astronomical switches are particularly suitable for use in applications where the operation of a twilight switch with external sensor is potentially subject to alteration or damage from external agents (e.g. smog, overexposure to light, vandalism etc.).

Example of installation

One cause of reductions in the level of ambient light is atmospheric smog. Particle deposits on the external sensor of a traditional twilight switch can over time compromise its operation, preventing the activation of the lighting systems controlled. As illustrated in the diagrams, it is possible to counter this type of problem by installing a TWA twilight astronomical switch, which controls the lighting based on the ambient light level calculated from the preset longitude and latitude parameters.

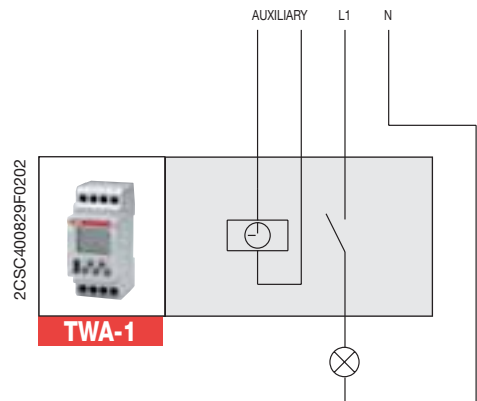

2CSC400829F0202

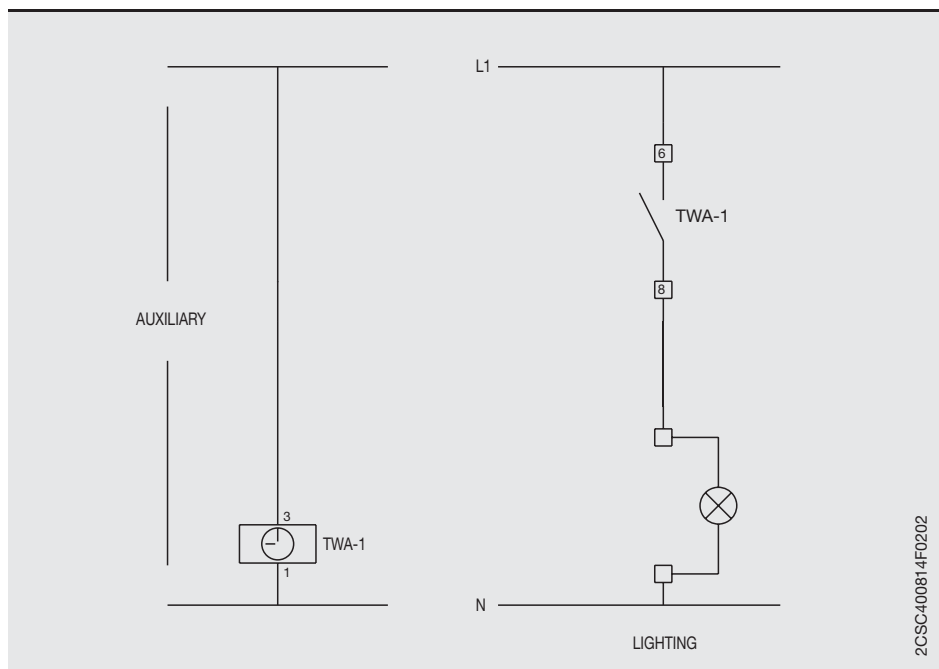

2CSC400814F0202



2CSC400830F0202

Operating principle

Modular thermometers let you control and keep a heating or cooling element at a set temperature, comparing the value read by the sensor with the one set by the user.

The THS range can thus guarantee switchboard operating reliability, perfect product conservation in refrigerated counters or cells, promote greenhouse production, optimise drying cycles, etc.



Application environments

THS thermostat installation is thus the best way to regulate temperature in automation and distribution switchboards, in heating systems, in industrial applications or to control refrigerator systems, greenhouses, dryers or isothermal folding portals.



Example of installation

As shown in the diagrams, one of the possible applications consists in the installation of a THS-S modular thermostat inside an automation or distribution switchboard where the temperature must be kept at a set value. Thanks to the THS-S thermostat, you can thus control the temperature, permitting cooling regulations between +20 ÷ +60 °C and anti-condensation between 0 ÷ +10 °C. Furthermore, you can manage up to 3kW of point heaters without having to use any external contactors to manage the load.

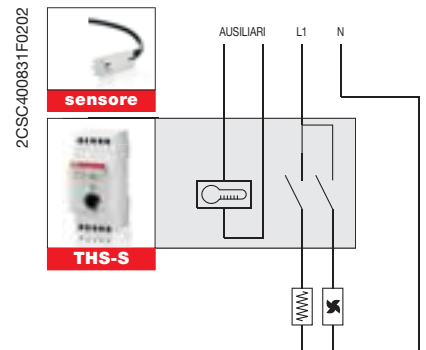

2CSC400831F0202

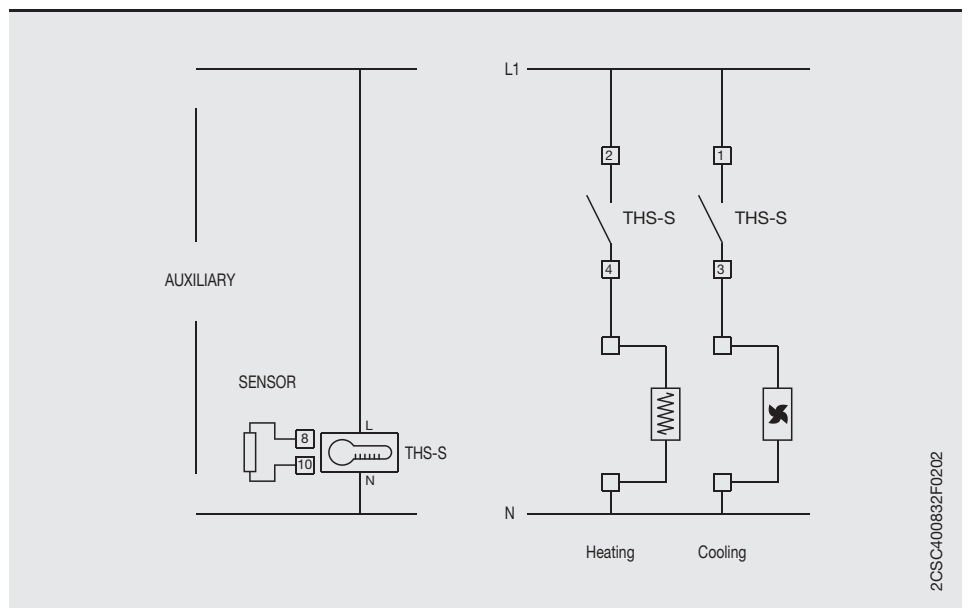

2CSC400832F0202



2CSC400833F0202

Operating principle

ATT-22 module is a GSM terminal with 2 outputs and 2 inputs for transmitting commands and alarms via SMS message, free phone call ring, fax or e-mail. Configuration is accomplished by means of SMS messages, or using the ATT-Tool software with ATT-22 connected to a PC.

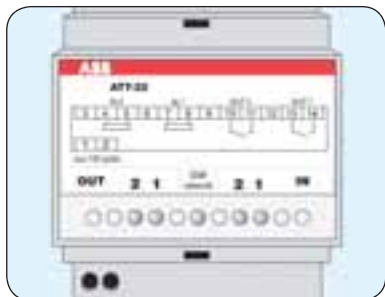

Application environments

The ATT-22 module is especially suited for residential and services-sector installations in which loads need to be remotely monitored or controlled. ATT-22E version is equipped with a pre-wired external antenna, indispensable when the module is installed in places that do not guarantee adequate GSM coverage.

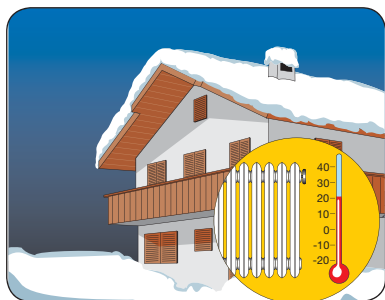

Example of installation

The figures illustrate an example application in which ATT-22 module is installed in the control panel of a second home in the mountains. With a cell phone call ring to ATT-22, it is possible to switch on the boiler just before arriving at the house, or to keep it continually in operation. In the event of a problem with the boiler, ATT-22 sends a notification SMS.

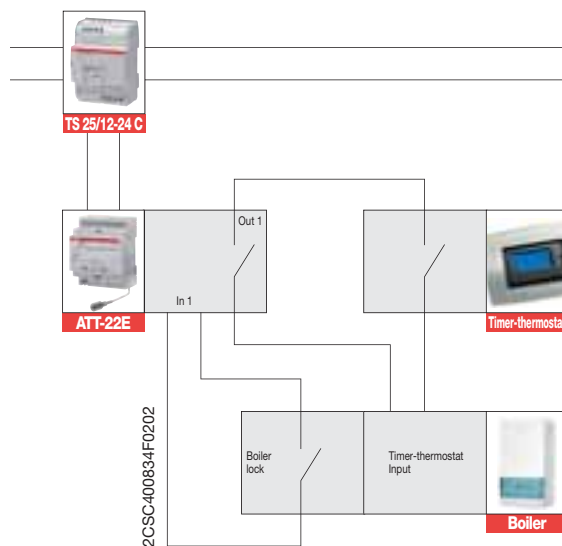

2CSC400834F0202

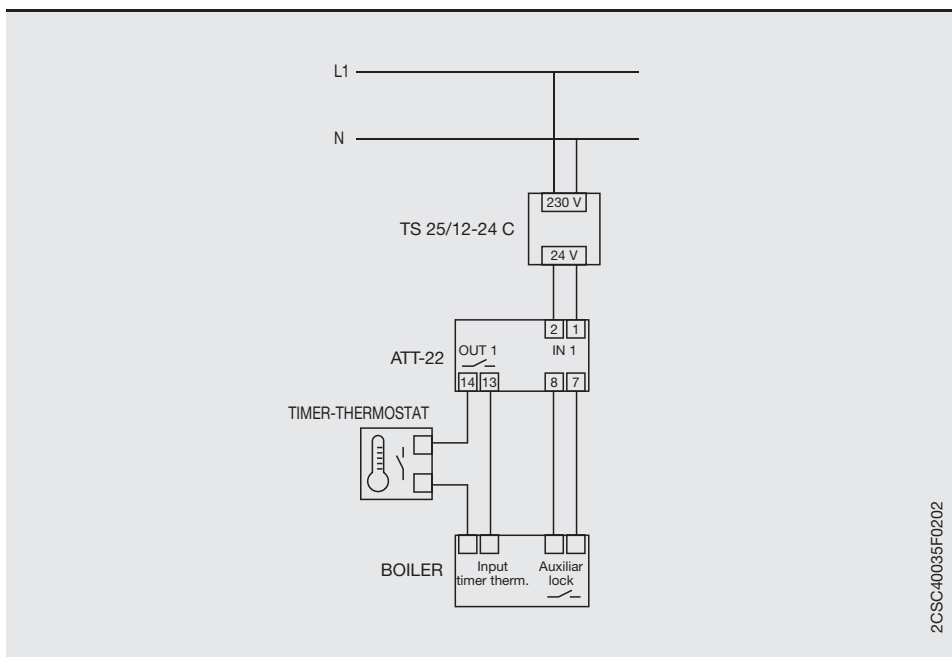

2CSC40035F0202

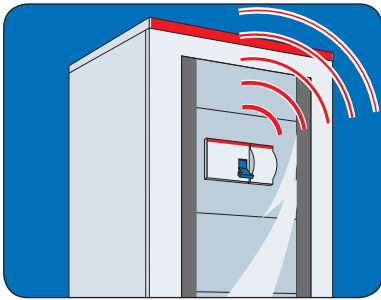

2CSC400836F0202

Operating principle

ATT-81 module is a GSM terminal with 8 inputs and one output for transmitting commands and alarms via SMS message, free phone call ring, fax or e-mail. Configuration is accomplished by means of SMS messages, or using the ATT-Tool software with ATT-81 connected to a PC.



Application environments

ATT-81 module is ideally suited to industrial and services-sector installations which require loads to be remotely monitored or controlled. ATT-81E version is provided with a pre-wired external antenna, indispensable when the module is installed in places that do not assure adequate GSM coverage.

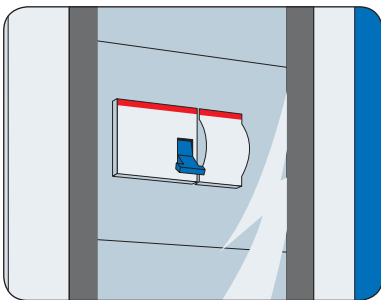

Example of installation

The figures illustrate an example application in which ATT-81 is installed in the circuit of an unsupervised facility. In the event of a power outage, ATT-81 sends an alarm notification to the list of authorised users, while at the same time actuating the motor-driven command which reinstates the power supply.

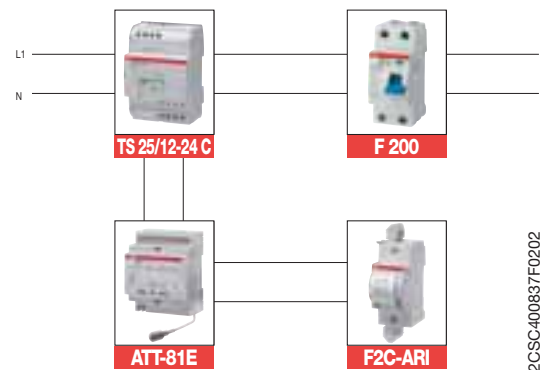

2CSC400837F0202

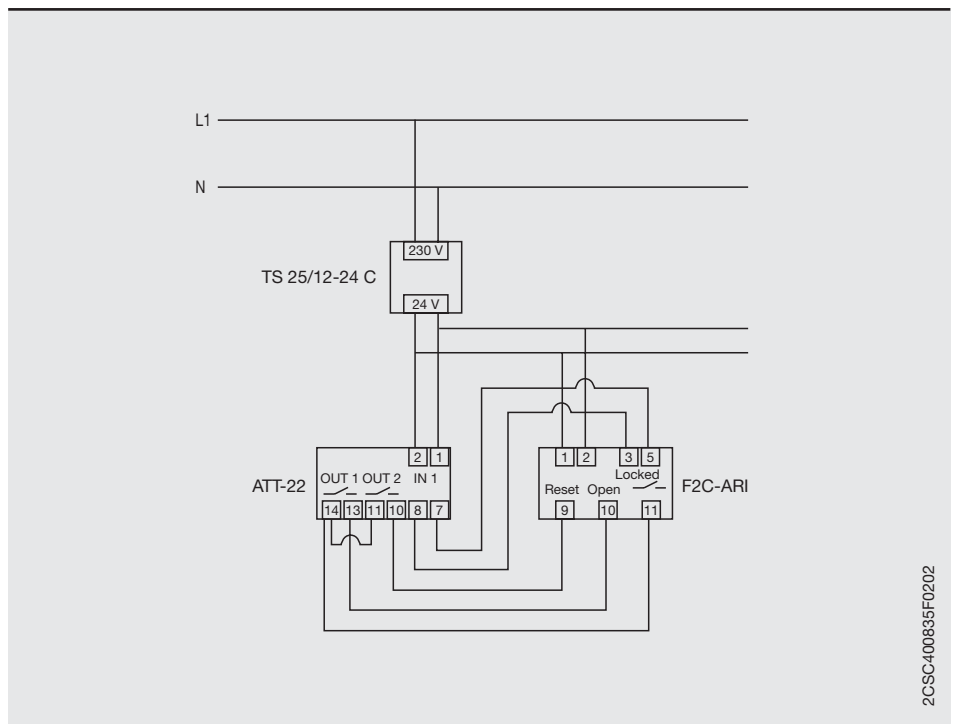

2CSC400835F0202

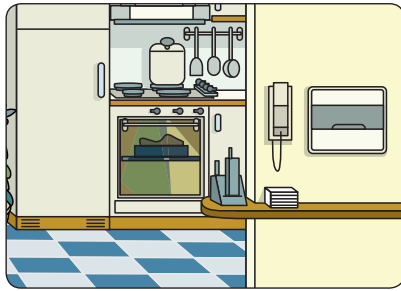

2CSC400839F0202

Operating principle

The RAL overload alarms constantly compare the maximum preset power consumption value to effective system power consumption. Approaching allowed threshold, they signal to disconnect one of the loads through acoustic alarm avoiding the main circuit breaker tripping. Connecting the undervoltage release to the appropriate contact, the RAL overload alarms provide an acoustic alarm and simultaneously opens the circuit-breaker protecting one or more not primary loads.

Application environments

The installation of the RAL overload alarms is suitable for any environment and situation in order to avoid power consumption which could trip the limiting circuit breaker of the system.

Example of installation

As shown in the diagrams, one of the possible applications is the installation of the RAL overload alarms in the domestic system where the electric oven and washing machine are simultaneously switched on increasing the power consumption. When the power consumption approaches the preset threshold values, an acoustic alarm is activated and the washing machine switches off automatically through an undervoltage release.

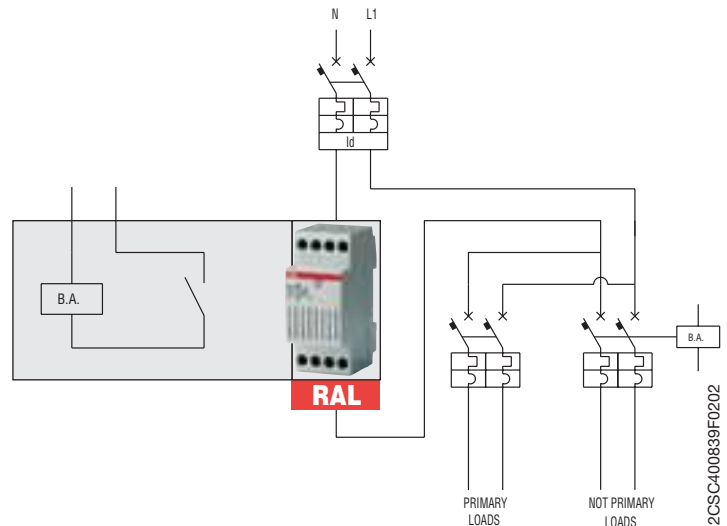
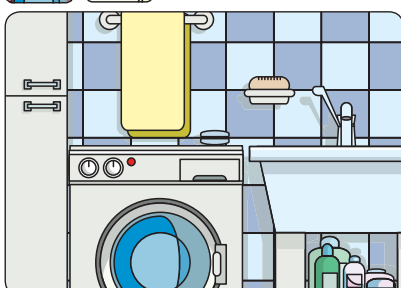
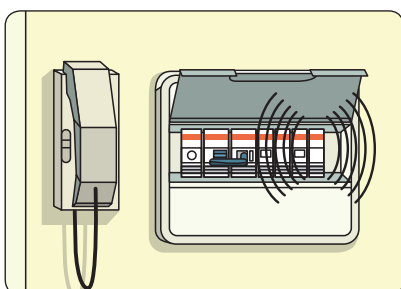
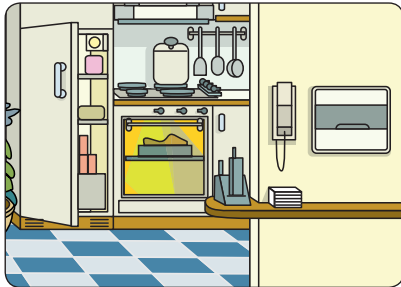

2CSC400839F0202

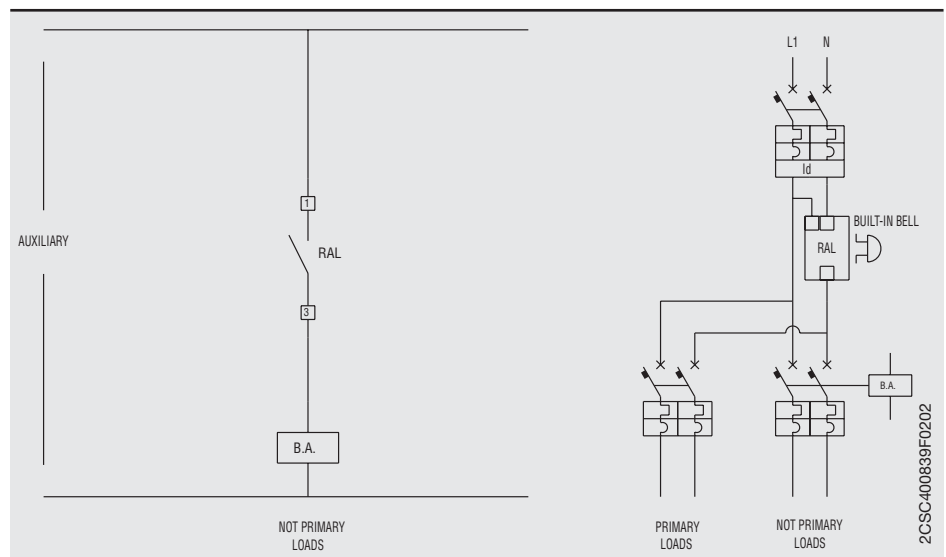

2CSC400839F0202



2CSC400841F0202

Operating principle

LSS1/2 load shedding switches are used in case of exceeding of consumption threshold allowed in the system by switching off in sequence one or two loads, if necessary. At preset intervals and until current consumption is not below the reference level, the switch tries to reset the disconnected loads.

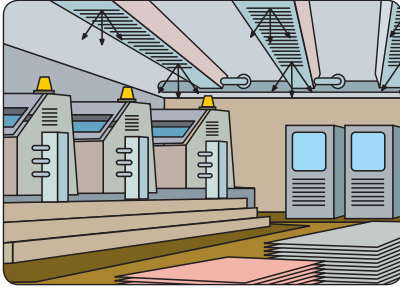

Application environments

The installation of the LSS1/2 load shedding switches is suitable for any environment and situation where it is necessary to control electric energy consumption within consumption limits allowed in the system.

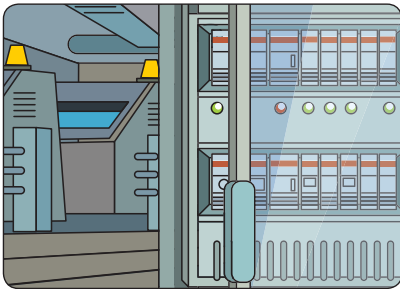

Example of installation

As shown in the diagrams, one of the possible applications is the installation of the LSS1/2 load shedding switches in a printing office system, where the conditioning switch-on causes the exceeding of the energy consumption threshold defined with the supplying company by contract. The LSS1/2 load shedding switch preserves printing machines operation by switching off one or two primary loads automatically (i.e. night conditioning and lighting), where ON red leds indicate temporary OFF. After a preset interval, the switch checks that current consumption values fall within the limits again trying to reset the previously disconnected loads.

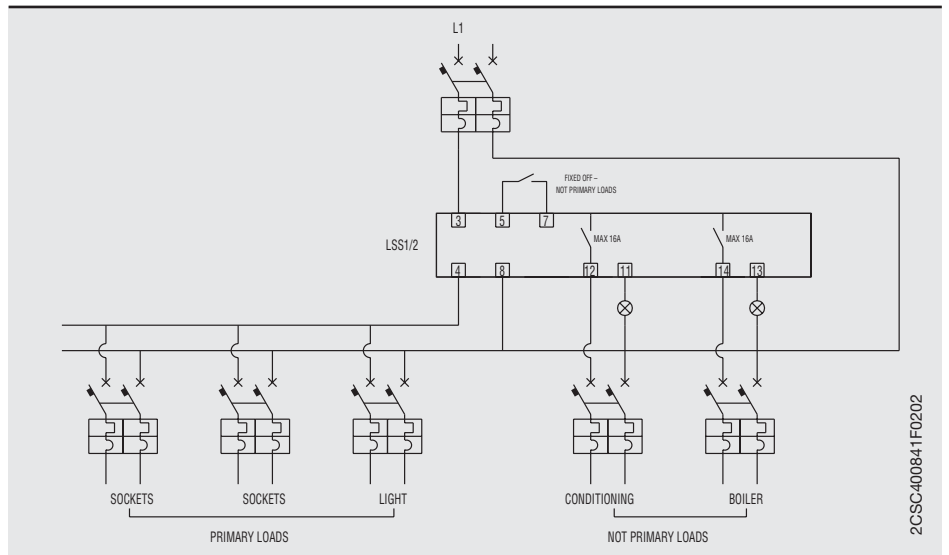
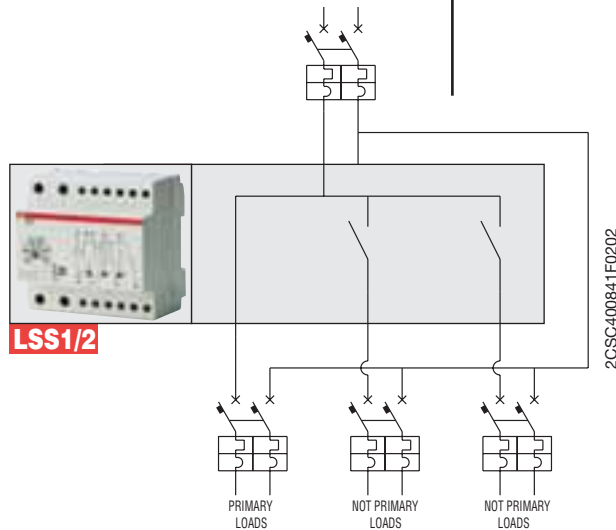



2CSC400842F0202

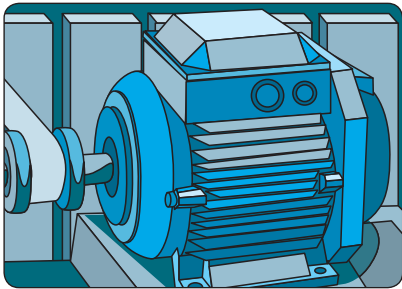
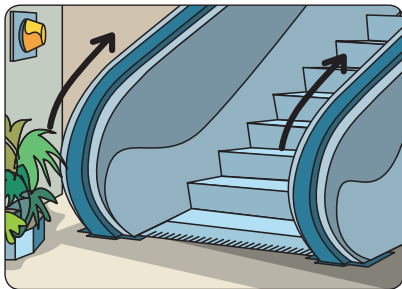

Operating principle

Through an output relay with contact in safety switching, the SQZ3 phase and sequence presence devices for 400 V a.c. three-phase networks enable the phase and sequence presence management monitoring also the minimum voltage (adjustable up to 70% of V_n). In case of any defect, the device operates within a range from 2 to 20 seconds, with the opportunity to control the appropriate acoustic signals, motor controlling contactors or circuit breakers.

Application environments

The installation of the SQZ3 phase and sequence presence relays are particularly suitable for any environment and situation where it is necessary to control the three-phase network operation promptly signalling any defect.

Example of installation

As shown in the diagrams, one of the possible applications is the installation of the SQZ3 phase and sequence presence relays in a department store, where the escalator supply circuit has a phase variation determining the SQZ3 relay intervention on the ESB motor block and causing the motor block and the alarm lighting indication.

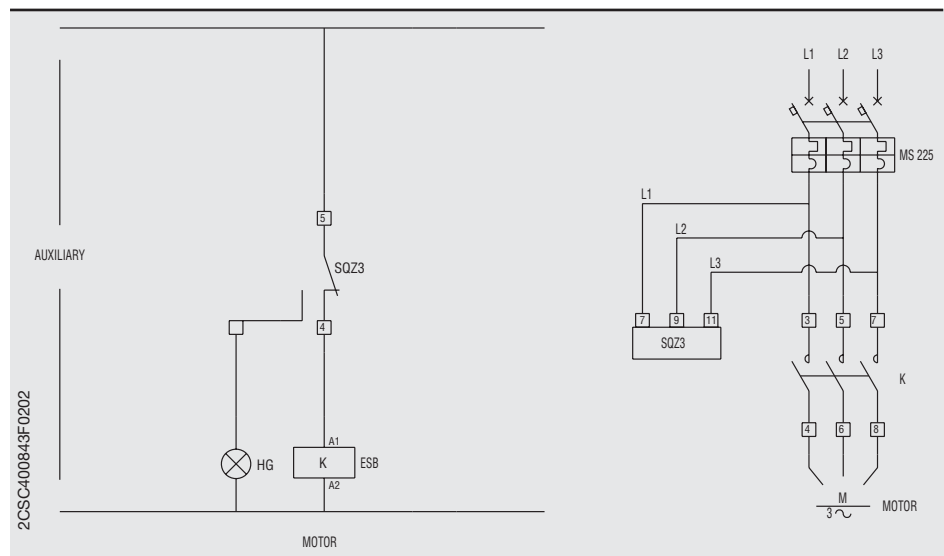
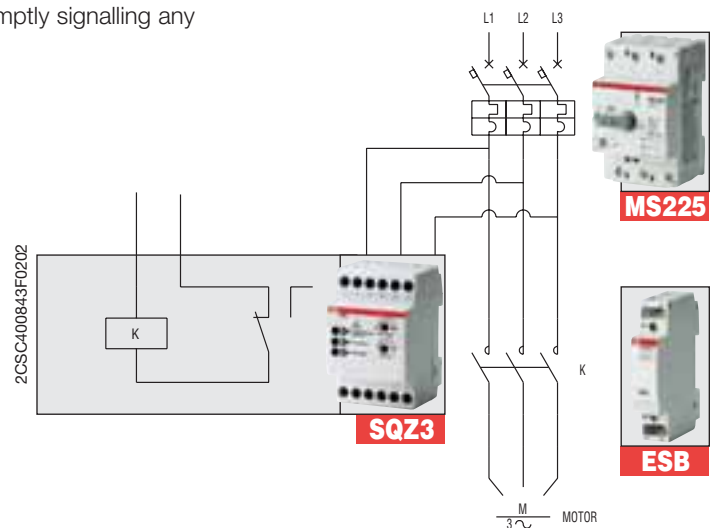

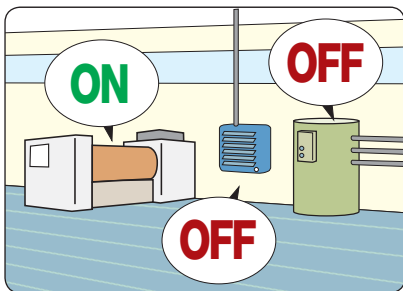
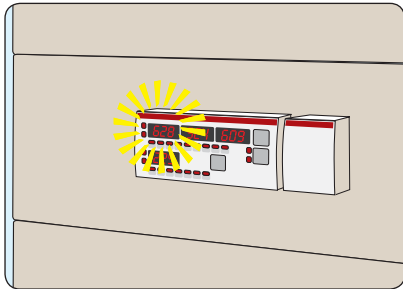
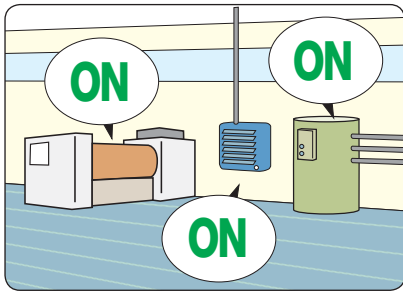

2CSC400844F0202

Operating principle

Beyond the custom functions of electric measure, the DMTME-I-485 multimeter is equipped with two programmable relays used as output alarms. The setting of the alarm thresholds of all the network electrical parameters allows the customer to hold always under control its own system.

Application environments

The installation of DMTME-I-485 multimeter is adapt in all those cases in which the customer must hold under remote control its own system. The use of the multimeter allows to set up system automation, to prevent malfunctions, dued to overloads and undervoltages, to manage maintainance and to prevent overcoming of the contractual power, avoiding penal from the energy supplier.

The multimeter can carry out the same functions of the LSS1/2 load shedding switch, with the advantage of allowing installation in three-phase systems, instead of only single phase systems.

Example of installation

A possible application is the installation of DMTME-I-485 inside an electrical distribution switchboard of an industrial system. It's possible to set up an alarm based on the total absorbed power from the system. When the power exceeds the set up threshold, the switching of the multimeter inner contact excitates the coil of an auxiliary external relay. The switching of the external relay, a ESB contactor or a E234 electronic timer, detaches a non primary load to lower the absorption levels of the entire system.

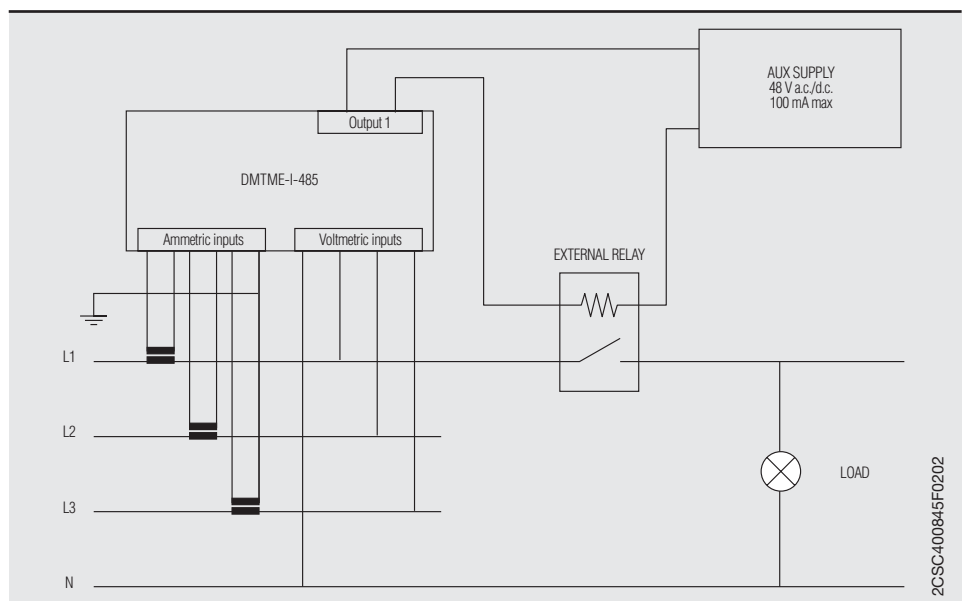

2CSC4008445F0202

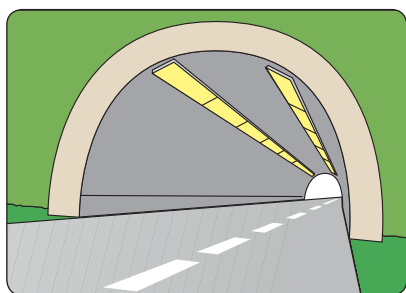

2CSC400846F0202

Operating principle

In addition to measuring the main electrical quantities, the DMTME-I-485-96 digital front panel multimeter has a serial port for implementing a communication network, and two digital outputs which can be configured as alarm outputs. Programmable alarm thresholds on all the electrical parameters of the network allow the user to continually monitor the entire installation.

Application environments

The DMTME-I-485-96 multimeter is ideal for those situations where users must remotely monitor their installation. The multimeter makes it possible to implement system automation, prevent malfunctions due to overloads and undervoltages, manage maintenance, and monitor the functioning of the installation.

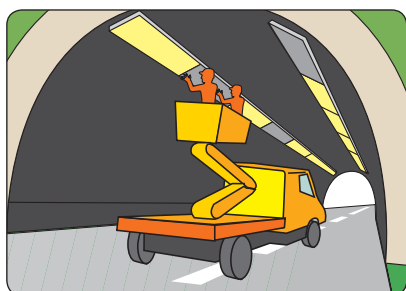
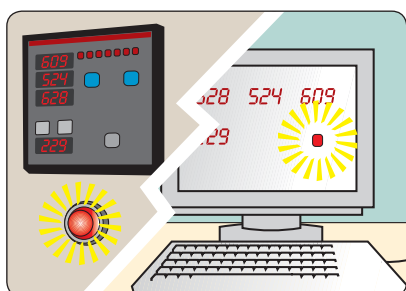
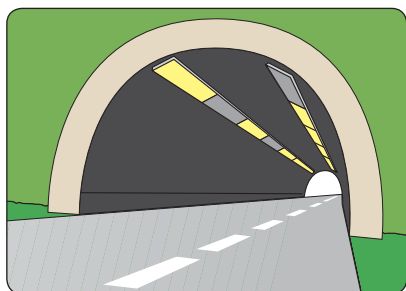

Example of installation

The figures show an application example in which the DMTME-I-485-96 is installed in a motorway tunnel panel, with an alarm threshold programmed on the total power consumption of the row of lights.

If one or more lamps burn out, the total power consumption drops and triggers an alarm.

Remote acquisition of this data thus allows a maintenance technicians to be sent out only when effectively needed.

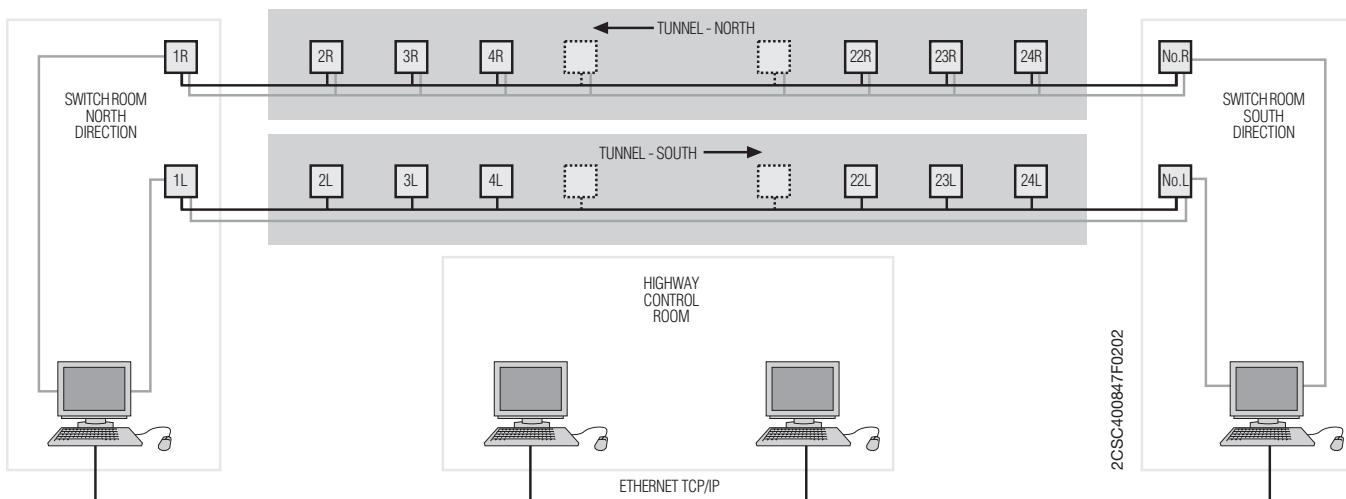

12

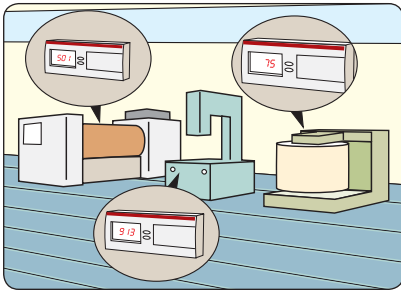

2CSC400848F0202

Operating principle

The ANR network analyser can perform a variety of functions. In this example the ANR is used as a data concentrator, acquiring incoming data from other measuring devices and energy meters, and as a load manager.

The digital outputs in fact allow alarm thresholds to be programmed which, if breached, will trigger audible and visible alarm signals, or command the energising of a relay coil or switch to disconnect a particular load, thereby implementing effective automated management of energy consumption to comply with the maximum power draw permitted under the contract with the energy supplier.

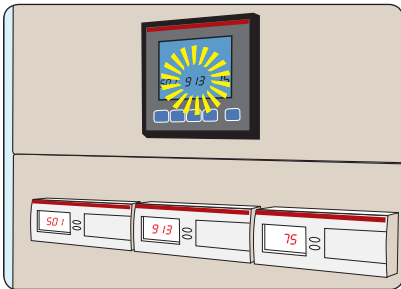

Application environments

ANR is suitable for industrial and services sector applications which require implementing control of energy consumption, optimising service continuity and managing the quality of the network.

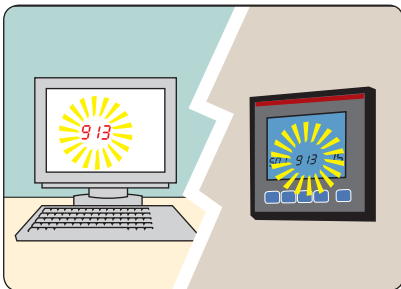

Example of installation

As illustrated in the figures, the ANR can be used to allocate power consumption among production cycles and track the share of energy costs in the total product cost.

Through its digital inputs, the ANR is able to acquire the pulse signals output by various energy meters and thus keep track of their totals.

M1173-L-R red modular socket with
indicator light

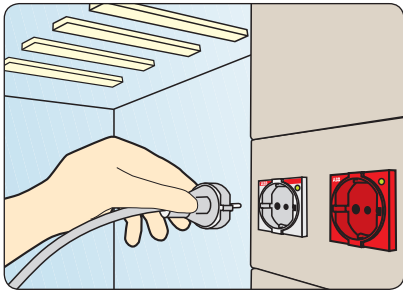

2CSC400849F0202

Operating principle

The colour-coded modular sockets are suitable wherever the specific purpose of a socket must be clearly indicated to unequivocally distinguish it from the other sockets in the panel.

The indicator light signals the presence of the supply voltage, showing immediately whether or not the socket is under power.

Application environments

The modular sockets are suitable for installation in all electrical distribution or automation panels, to allow the connection of non-modular devices such as measuring or maintenance instruments, etc.

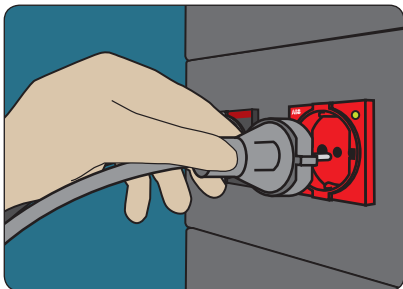
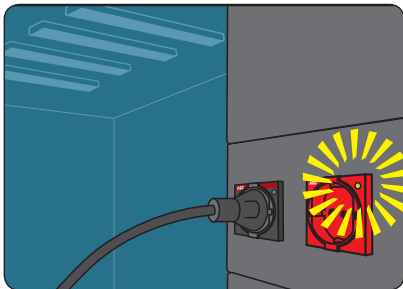

Example of installation

As illustrated in the figures, a modular socket can be used to supply non modular devices directly from the electrical panel.

It is possible to use a red socket to indicate that it is supplied through a UPS and therefore should be used only in case of emergency.

Using a socket with indicator light also provides a clear indication of whether the upstream supply is connected.

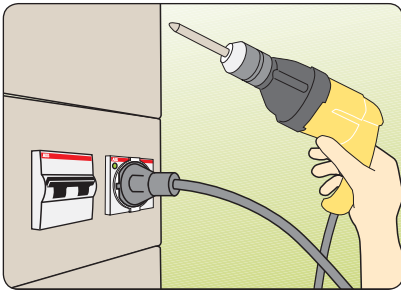

2CSC400850F0202

Operating principle

The modular sockets with fuse are ideal wherever continuity of service is essential. The embedded fuse protecting the phase prevents tripping of the main protection switch in the event of a malfunction of the device plugged into the socket.

Application environments

The modular sockets are suitable for all electrical distribution or automation panels, to allow connection of non modular equipment such as measuring and maintenance instruments etc.

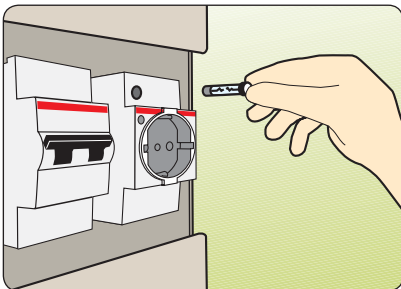
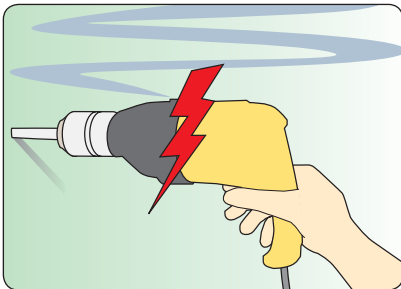

Example of installation

***As illustrated in the figures, a modular socket allows to supply non modular devices directly from the electrical panel.
If the connected device malfunctions, there is the risk that the entire electrical system will be put out of service due to tripping of an MCB.
This is prevented by blowing of the fuse incorporated into the socket, thus assuring continuity of service.***

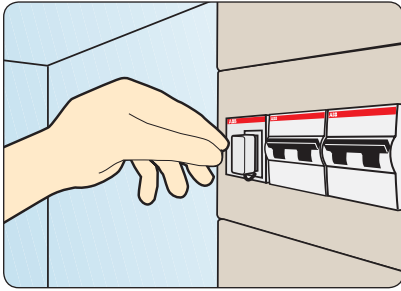

2CSC400851F0202

Operating principle

MeMo2 is USB device for DIN rail in two modules width to store and keep handy useful electronic information, such as files and applications, directly in the switchboards.

No electrical wiring is required, just mount the device on DIN rail choosing a convenient position to easily connect it to the PC.

MeMo2 is provided with a bidirectional roll cable to connect the device to all USB ports of your PC.

The PC or laptop automatically recognizes the device as an external memory allowing the transfer of files - no additional software is required.

The 60 cm roll cable is compliant with USB 2.0 standard to ensure maximum speed and reliability in uploading and downloading data.

You can easily protect your files by installing any encryption software on MeMo.

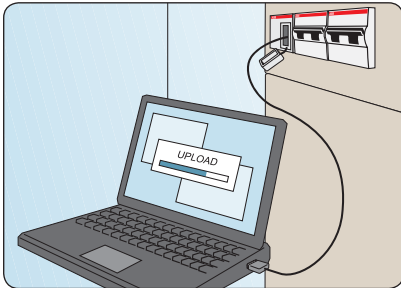

Application environments

MeMo is a useful device to get all your information inside switchboards or consumer units

Industrial applications:

- electric diagrams
- declarations of conformity
- products certifications
- test reports
- instructions
- warranties

Domestic applications:

- declaration of conformity for the installations (electric/thermal-hydraulic)
- maps and pictures of pipes of the building
- anti-intrusion system programming
- cadastral documentation if available in electronic format

Example of installation

Mounted in a convenient position inside the switchboard MeMo can save crucial information, files and applications concerning the plant. Data stored inside MeMo are always available for regular maintenance or in case of emergency.

Plus

- 2 GB and 4 GB versions
- information always available in the switchboard
- no more paper documentation
- save time: instant, easy and free update of documentation
- set up a master for serial switchboard
- easily find and edit your documentation
- customize information
- OEMs could save useful information such as spare parts list, technical assistance contacts, scheduled maintenance calendar.

Index

MCBs			
S 200	13/2	D Line and DTS digital time switches.....	13/36
S 200 U-UP	13/3	E 232 staircase lighting time delay relays ...	13/37
SN 201	13/3	THS modular thermostats.....	13/37
S 280	13/4	TW twilight switches	13/38
S 290	13/4	ATT GSM control and alarm monitors	13/38
S700 - WT 63	13/4	CL logic relays	13/39
S700	13/5		
S500	13/5	Load management devices	
S800	13/5	E 450 priority switches.....	13/40
		RAL overload alarms	13/40
RCDs		LSS1/2 load shedding switch	13/40
F 200	13/6	E 235 mains disconnection relays	13/41
DDA 200	13/7	SQZ3 phase and sequence relay.....	13/41
DS 200.....	13/8	Max./min. current/voltage ammetric and	
DS201, DS202C	13/9	voltmetric relays	13/41
DS 271	13/9	E 236 undervoltage monitoring relays.....	13/42
DDA for S 290, S800 and DS800 series.....	13/10	LEE 230 power failure signalling lamp.....	13/42
Electronic residual current devices		Measurement devices	
RD2, RD3, RD residual current devices and		Analogue measurement instruments.....	13/43
toroidal transformers.....	13/11	Digital measurement instruments.....	13/44
		MCV-MCA, QCA-QCV voltmetric and	
Auxiliary elements and accessories for		ammetric switches	13/45
MCBs and RCDs		DMTME multimeters.....	13/45
Auxiliary elements and accessories		ANR network analyzers	13/46
for S 200, F 200 and DS 200 series	13/13	CUS serial converters	13/47
Auxiliary elements and accessories		TMD temperature control units.....	13/47
for SN 201	13/16	TRF M.....	13/47
Auxiliary elements and accessories		CT current transformers.....	13/48
for S 280, S 290 and S800 series.....	13/17	CTO Split core current transformers	13/52
Other accessories	13/18	CTSM summing current transformers	13/52
		TV voltage transformers.....	13/53
MDRCs		CONV current and voltage converters.....	13/54
Surge Protective Devices		CNV transducers for power factor meters	13/54
OVR range.....	13/26	Shunts.....	13/55
		E 233 hour counters	13/56
Protection devices		HMT hour counters.....	13/56
E90, E 930 fuse holders.....	13/28	EMT electronic energy meter.....	13/57
EPD24	13/28	ODINsingle electronic single phase	
ILTS switch-disconnectors.....	13/29	energy meters.....	13/57
Insulation monitors.....	13/29	ODIN Meter electronic three-phase	
TI insulating transformers	13/31	energy meters.....	13/57
QSO electric panels for operating theatres...	13/31	DELTAsingle electronic single phase	
		energy meters.....	13/58
Command devices		DELTAplus, DELTAmx electronic	
E 200 switches.....	13/32	three-phase energy meters.....	13/58
E463/3, E480/3 switches.....	13/32		
E 210 switches.....	13/32	Other modular devices	
SL indicator lamps.....	13/33	TS-C safety isolating transformers for	
ESB/EN series contactors.....	13/33	general use	13/59
E 259 installation relays	13/34	TM/TS bell transformers	13/59
E 250 latching relays	13/34	Bells and buzzers	13/59
FLR pulse relays	13/34	CP-D primary switch mode power supplies	13/60
E 260 latching relays	13/35	TM-C, TM-S, TM-I control, isolation	
STD dimmers	13/35	and safety trasformers	13/61
E 234 CT-D electronic timers	13/35	Modular sockets	13/62
AT electro-mechanical time switches.....	13/36	MA1-8001 DIN rail adapter.....	13/62



S 200

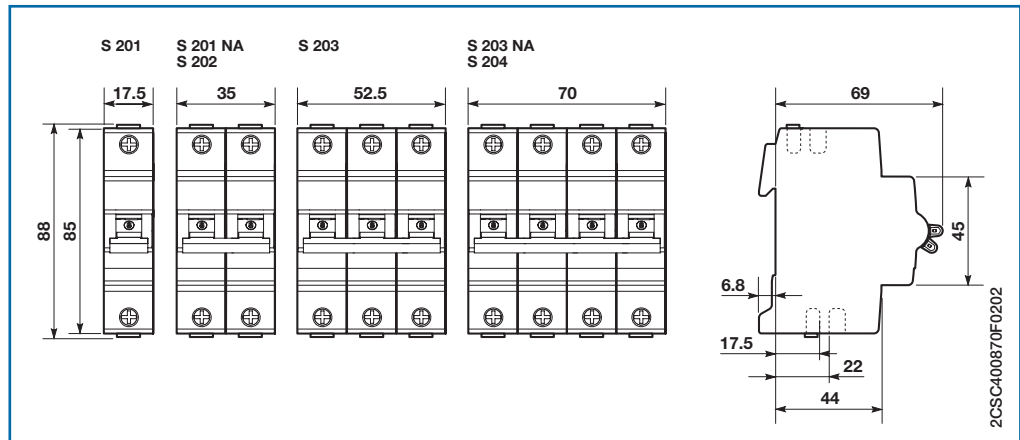

S 200 with bottom-fitting auxiliary contact

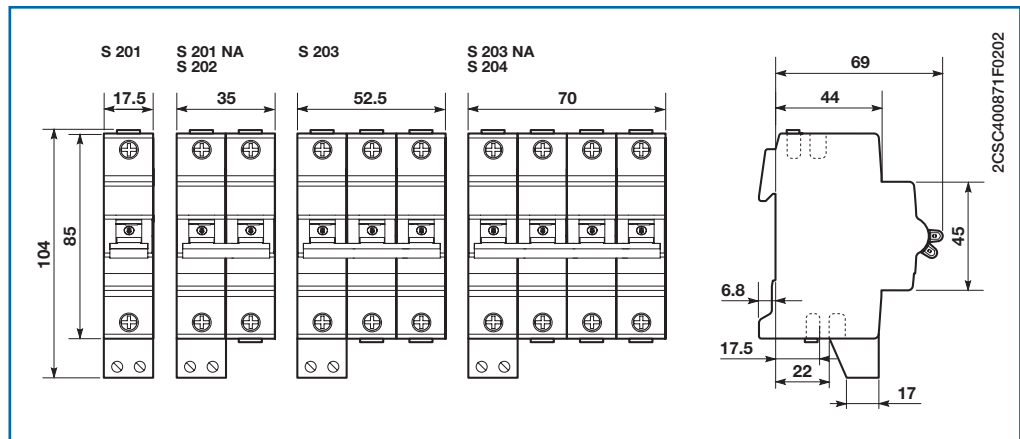



S 200 U-UP-UDC

S 200 U
S 200 UDC

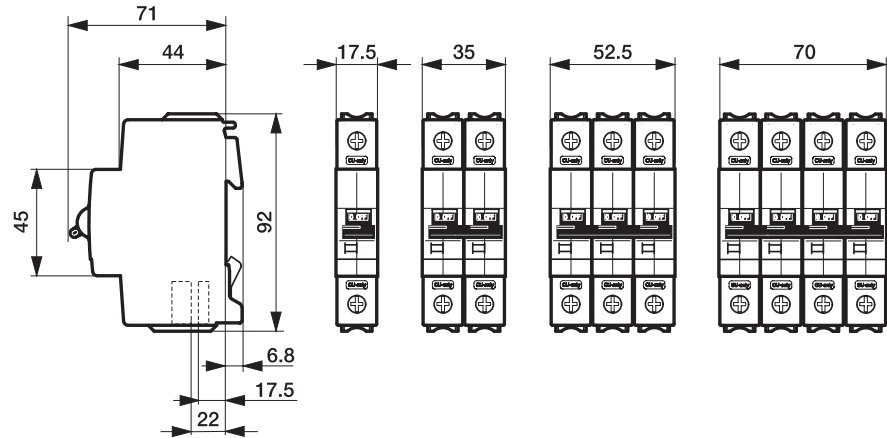

S 200 UP

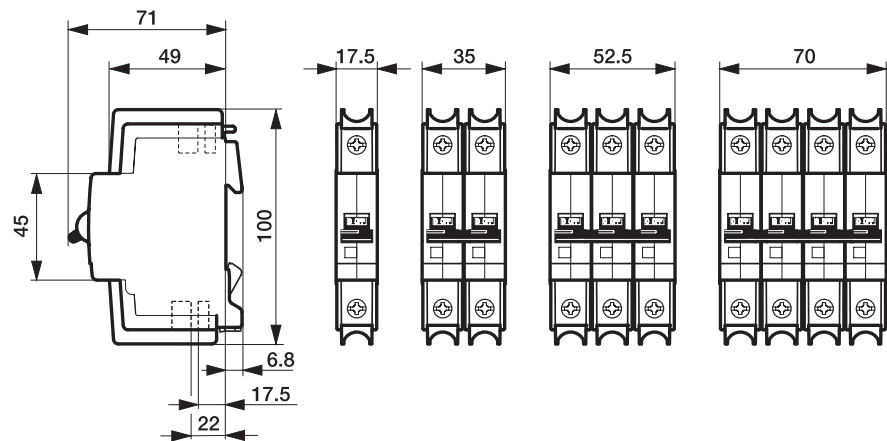

SN 201

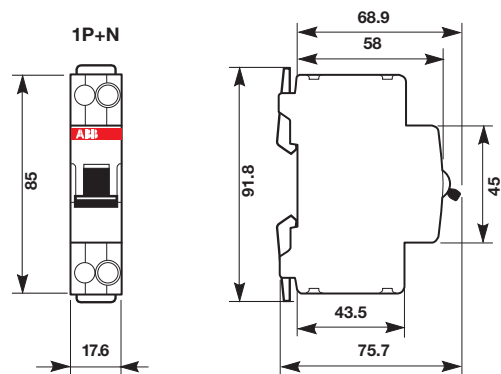

2CDC022024F0010

2CSC400872F0202



2CSC400475F0201

S 280

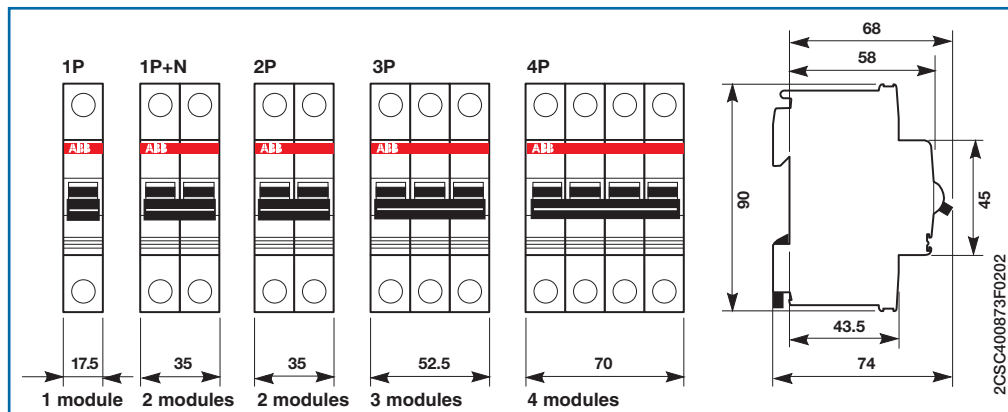

2CSC400482F0201

S 290

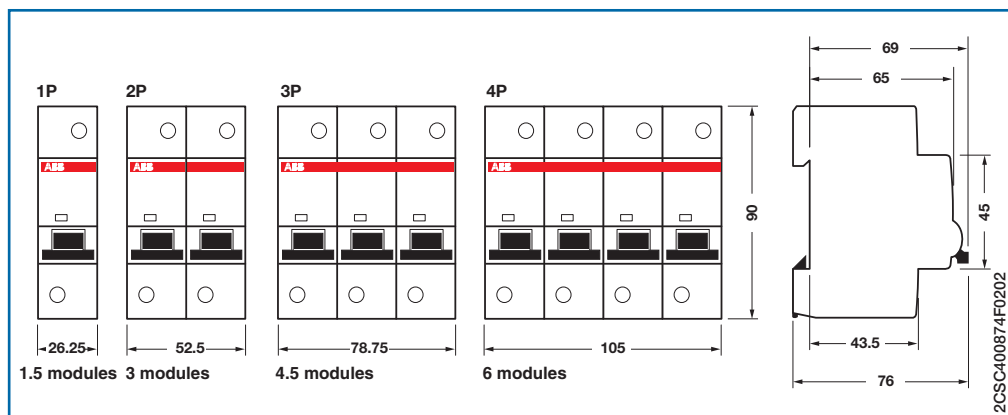

S0029b98

S 700 - WT 63

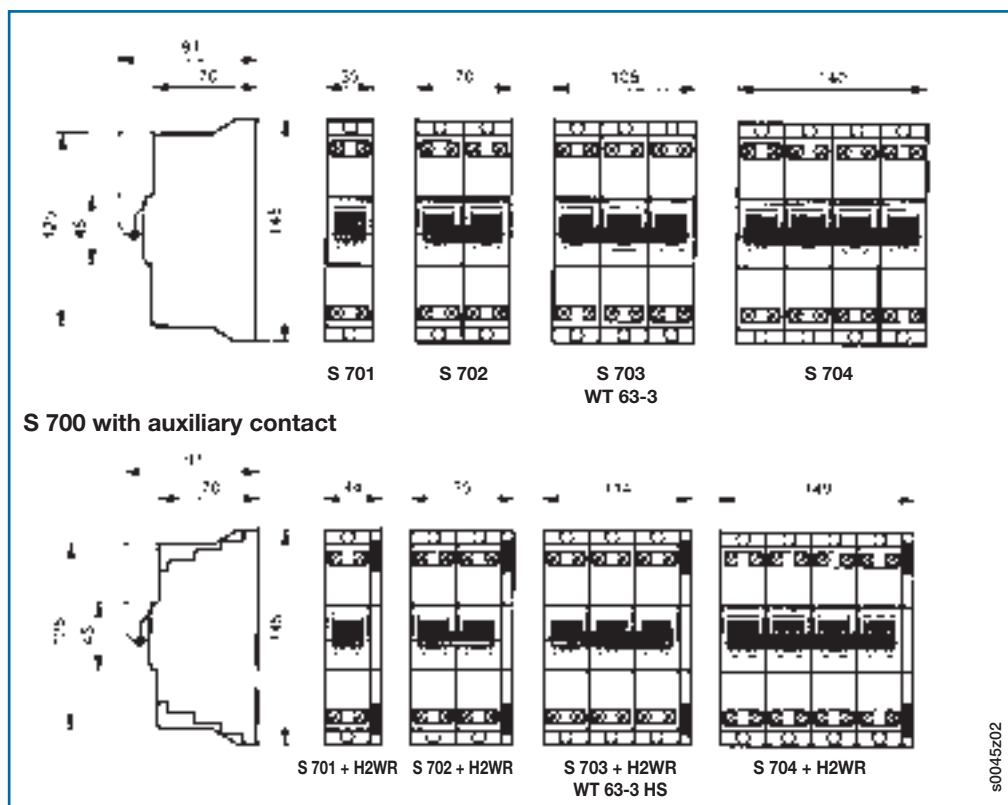

S 700

S 701 with DIN rail adapter



3 x S 701 with busbar adapter

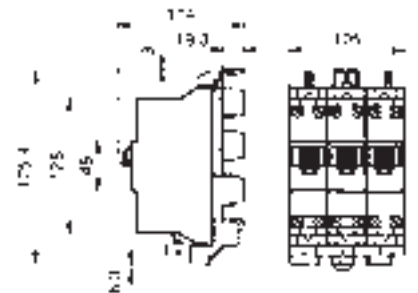

2CDC022450F0003

S800S, S800S-R, S800N, S800C, S800U, S800PV



2C0CC413223F0001

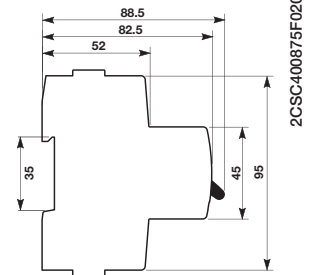
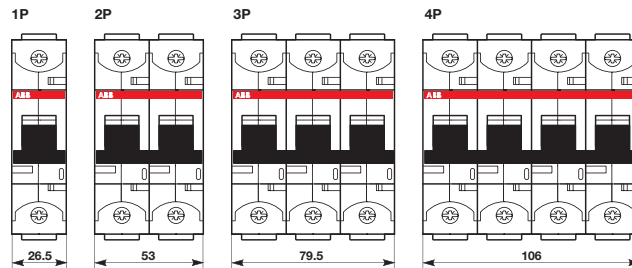

2CSC400875F0202

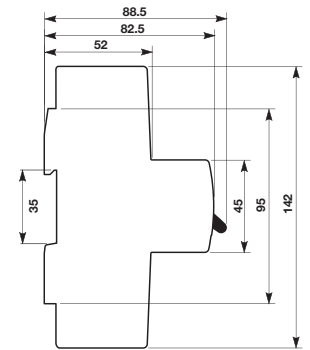
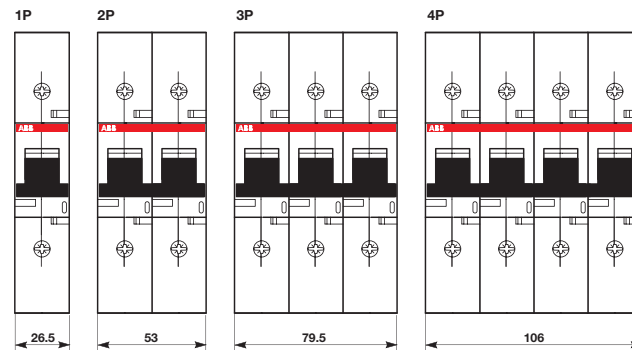

S500



2C0CC412001F0001

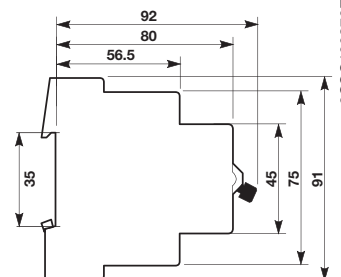
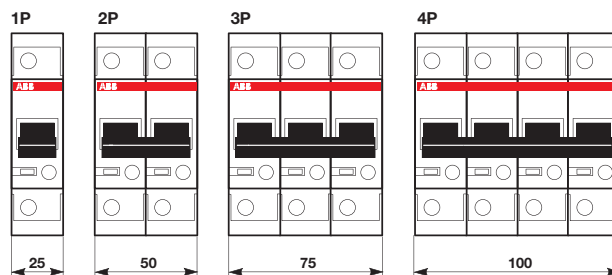

2CSC400876F0202



2CSC40087F0202

F 200

F 200

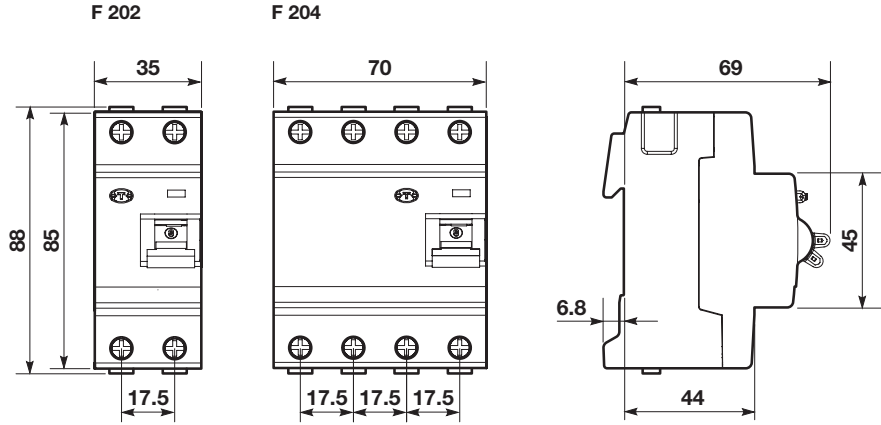

F 204 B, F 204 125 A, F 200 PV B

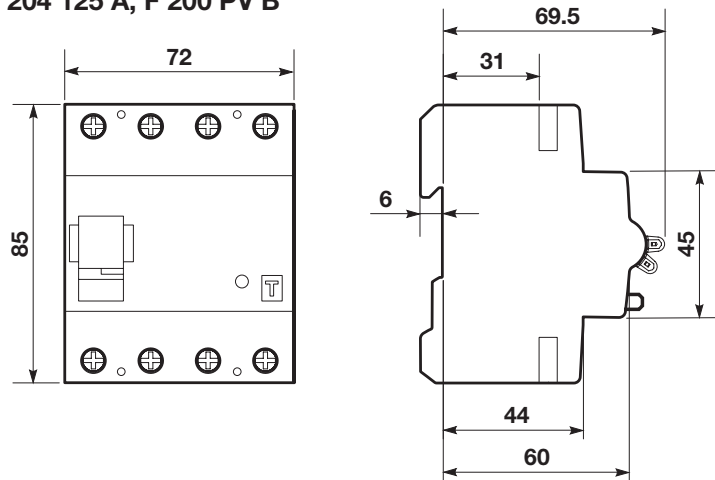

2CSC40087F0202



DDA 200

In=25-40 A

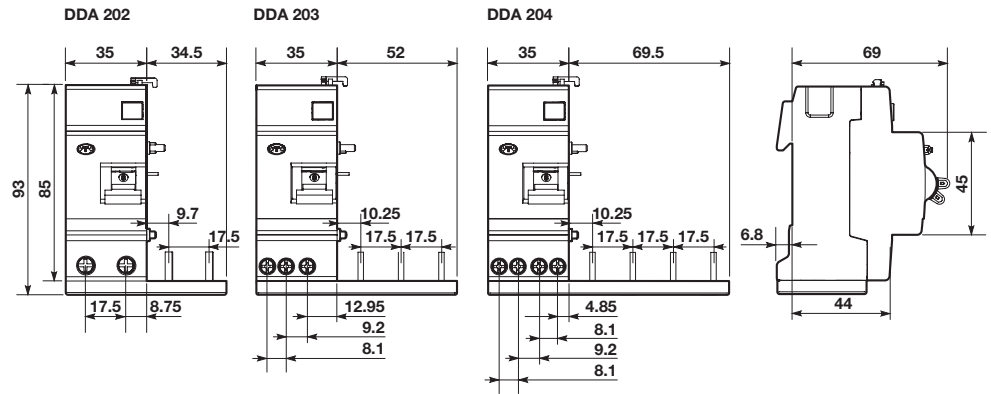

In=63 A

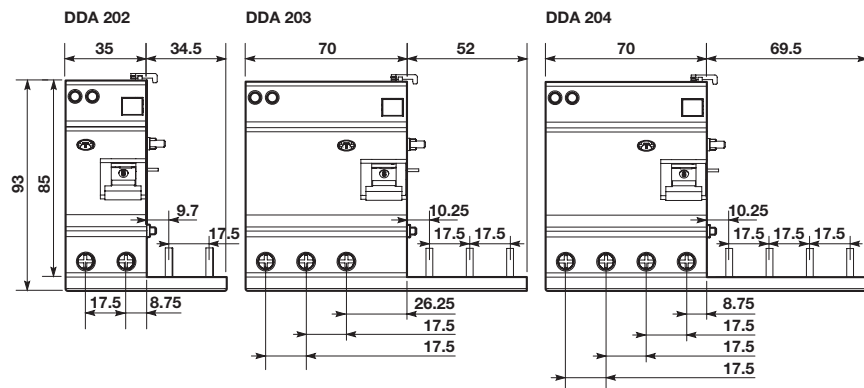

2CSC400879F0202



2CSC400193F0201

DS 200

In up to 40 A

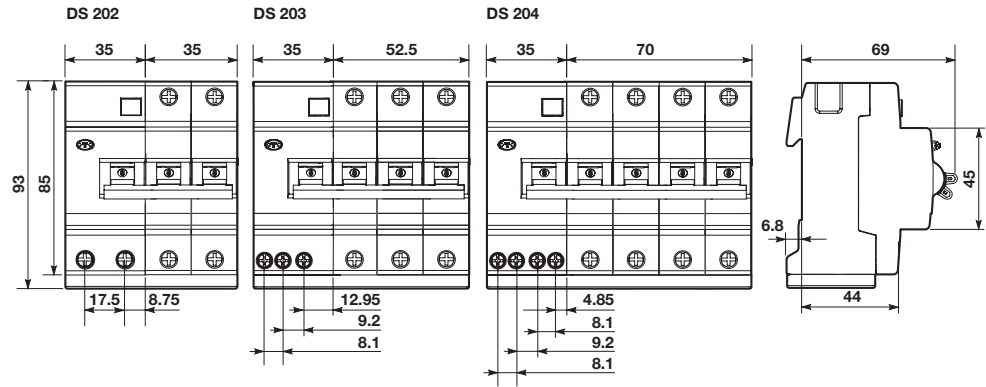

In = 50, 63 A

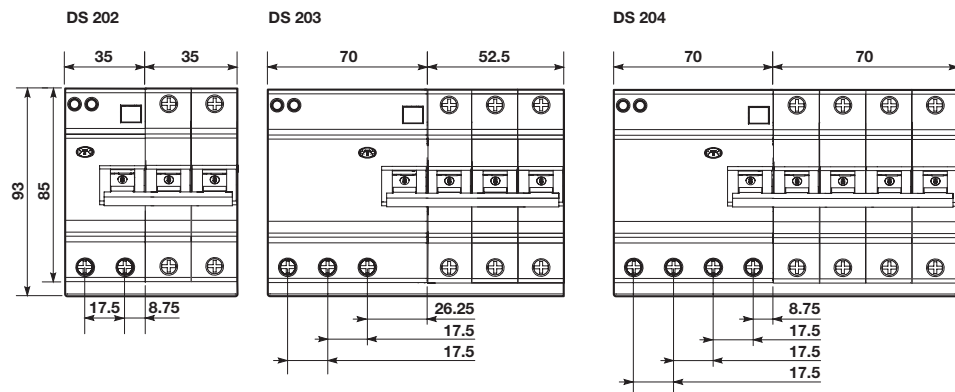

2CSC400880F0202



2CSC400881F0202

DS201, DS202C

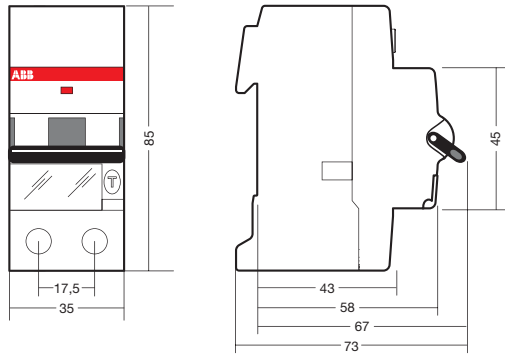

2CSC400882F0202



2CSC400407F0201

DS 271

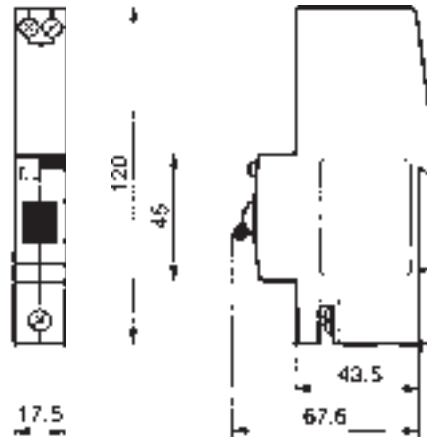

2CSC400195F0201



DDA for S 290 series

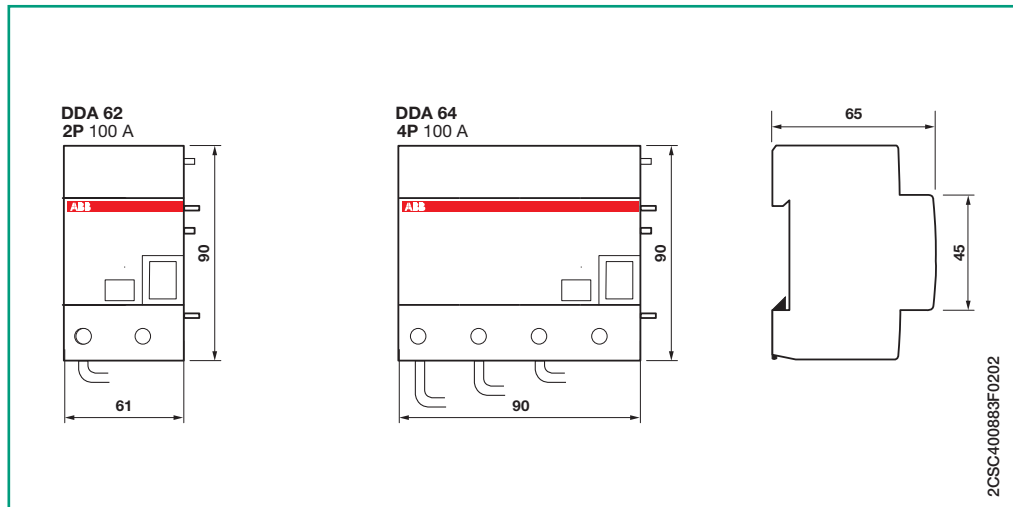

DDA 800 for S800 and DS800 series

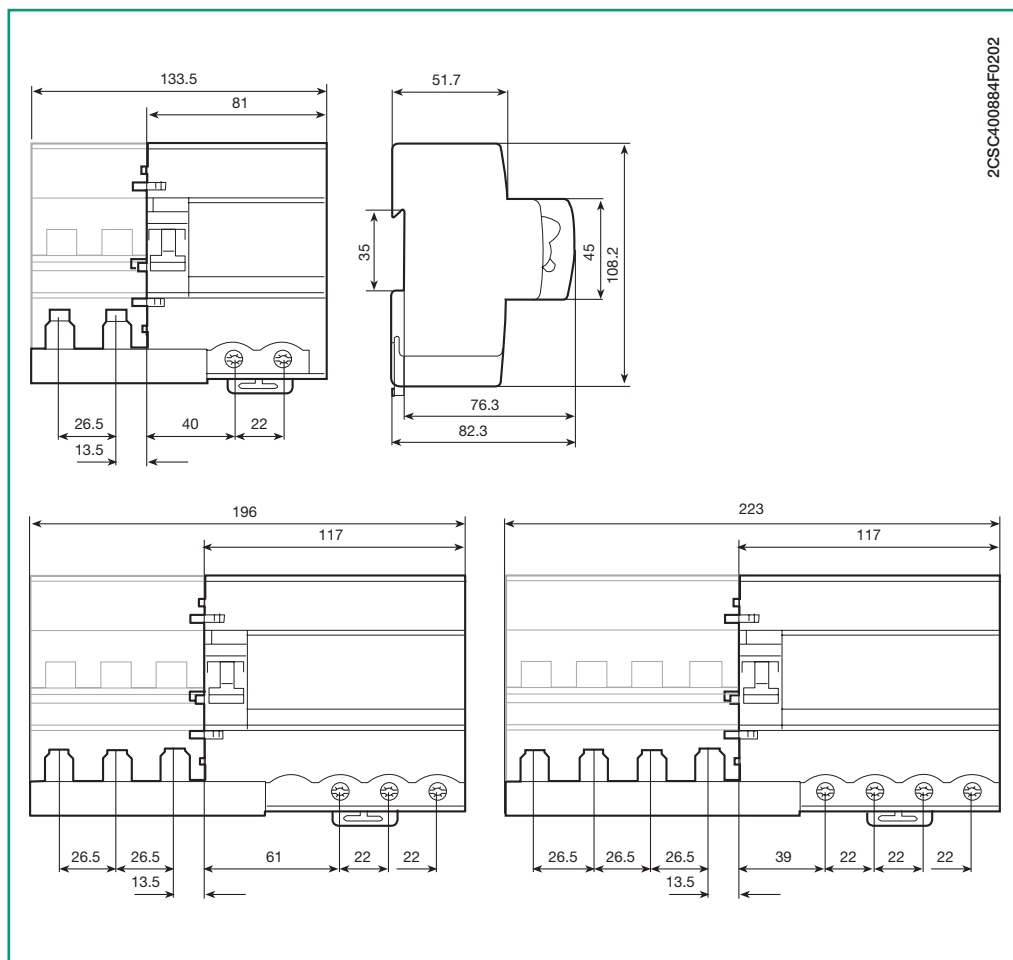



2CSC400320F0201

RD2 residual current relays

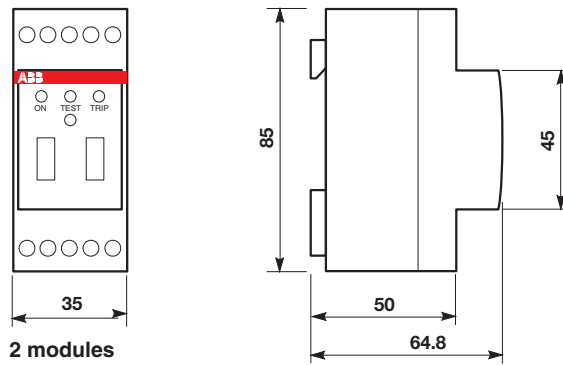

2 modules

2CSC400885F0202



2CSC445061F0001

RD front panel residual current relays

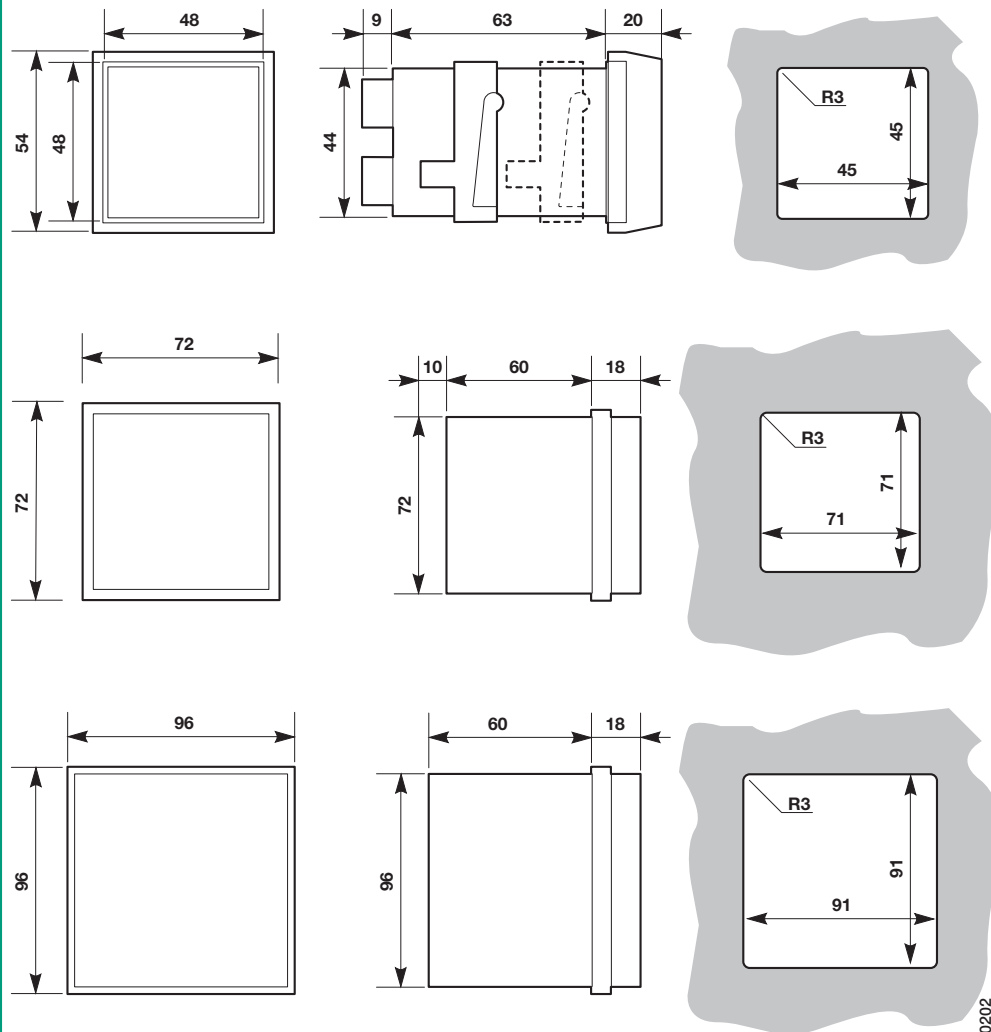

2CSC400885F0202



RD3 residual current relays

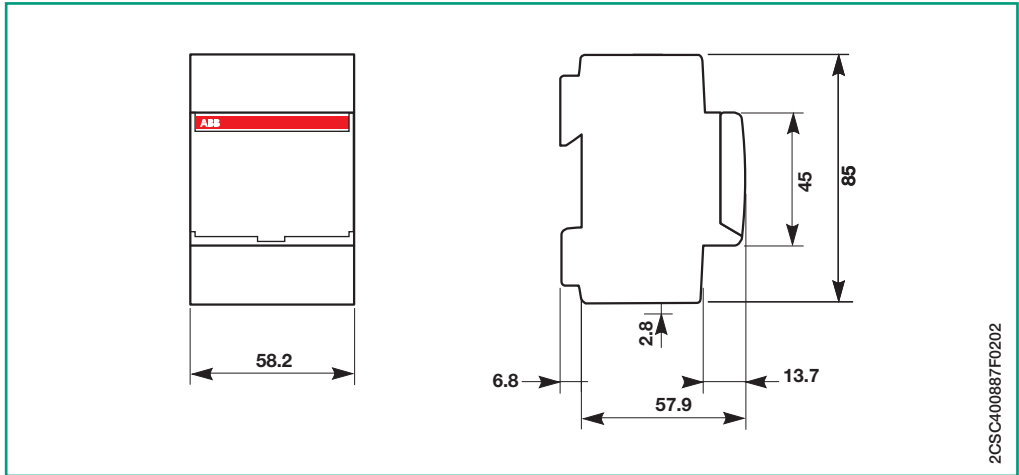

Toroidal transformers

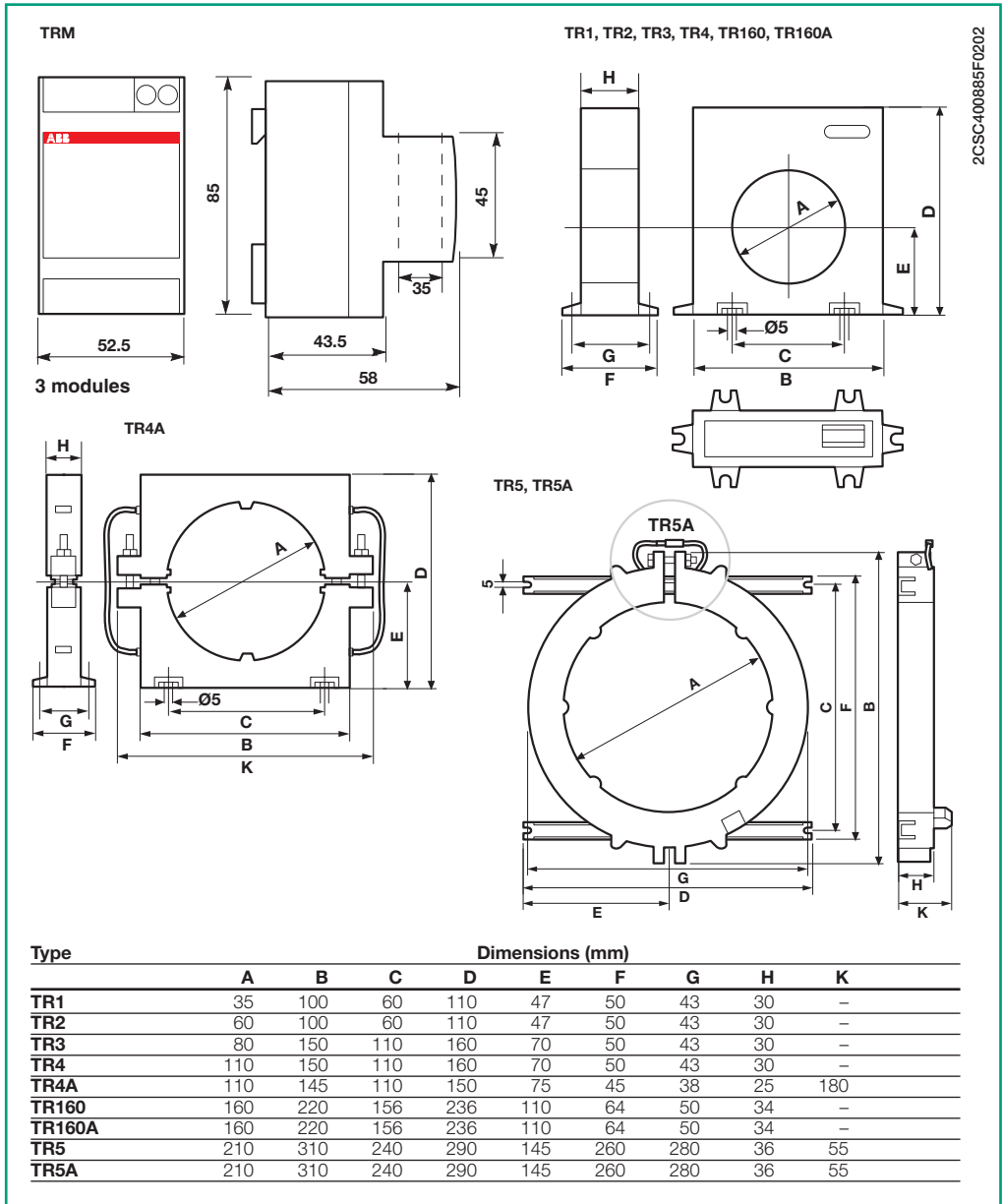

Auxiliary elements for S 200 and F 200 series



2CSC400465F0201

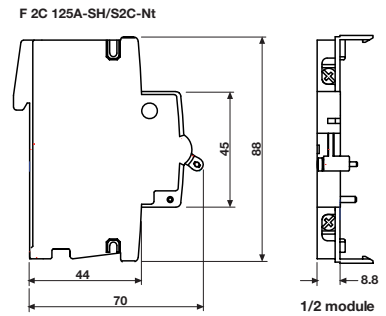
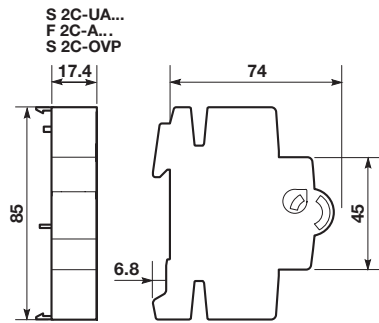
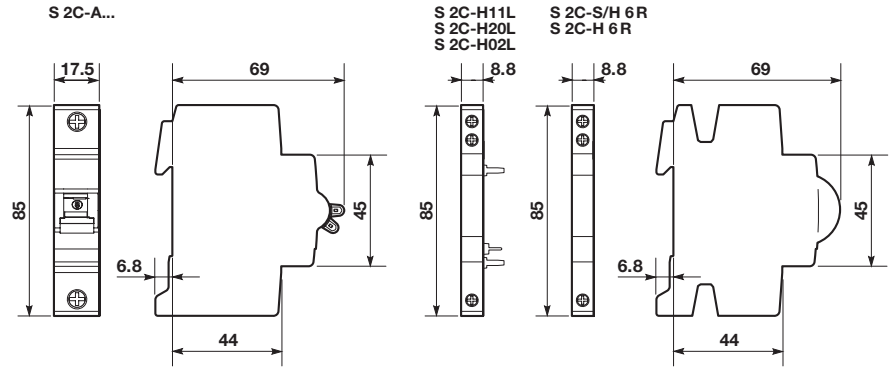

2CSC400889F0202

Bottom-fitting auxiliary contact (with S 200 MCB)



2CSC400155F0201

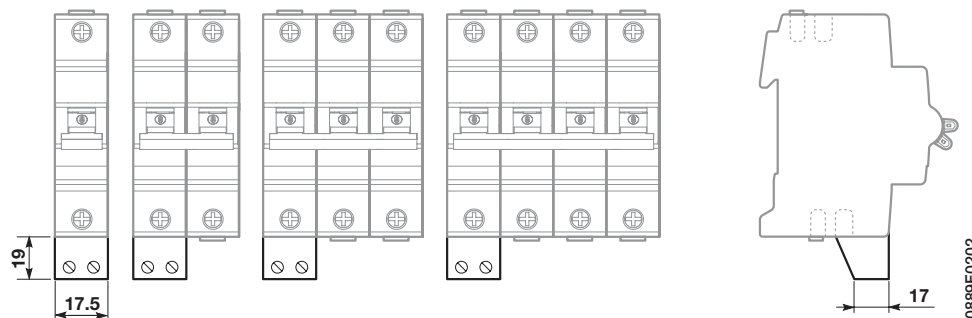

2CSC400889F0202

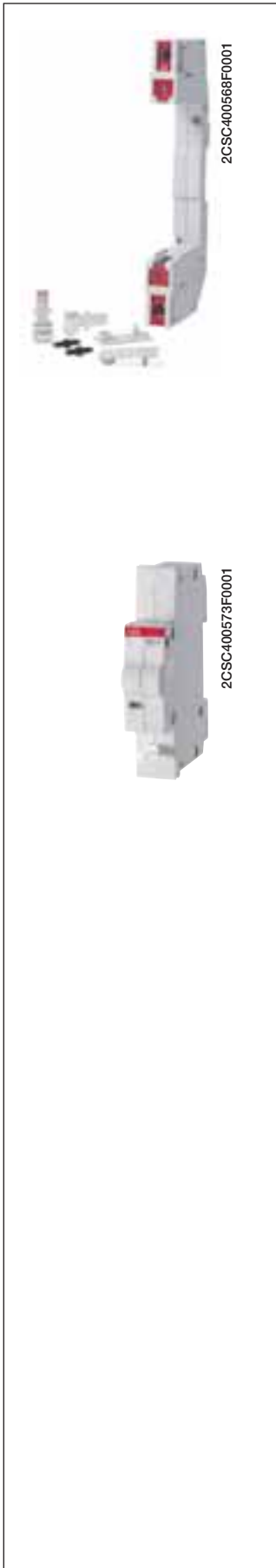

S 2C-EST

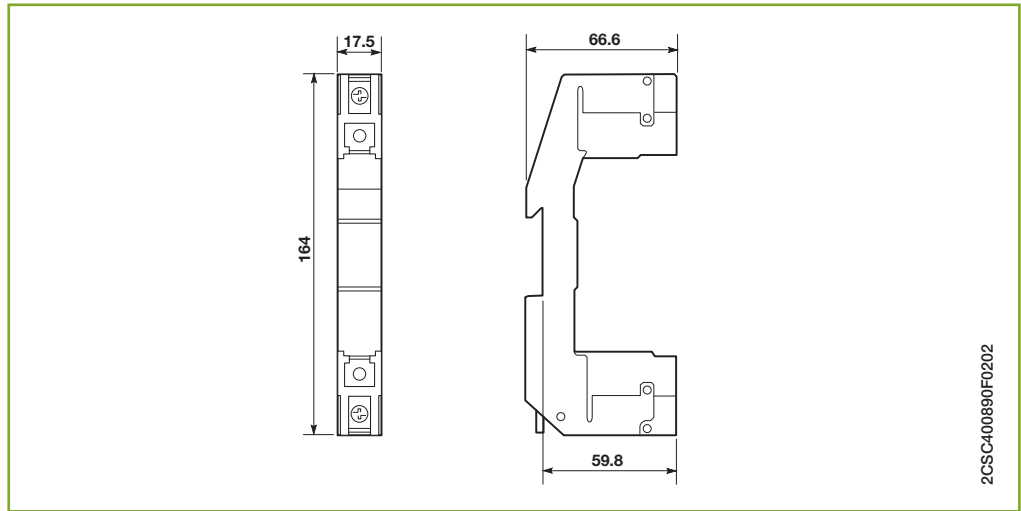

S 2C-BP

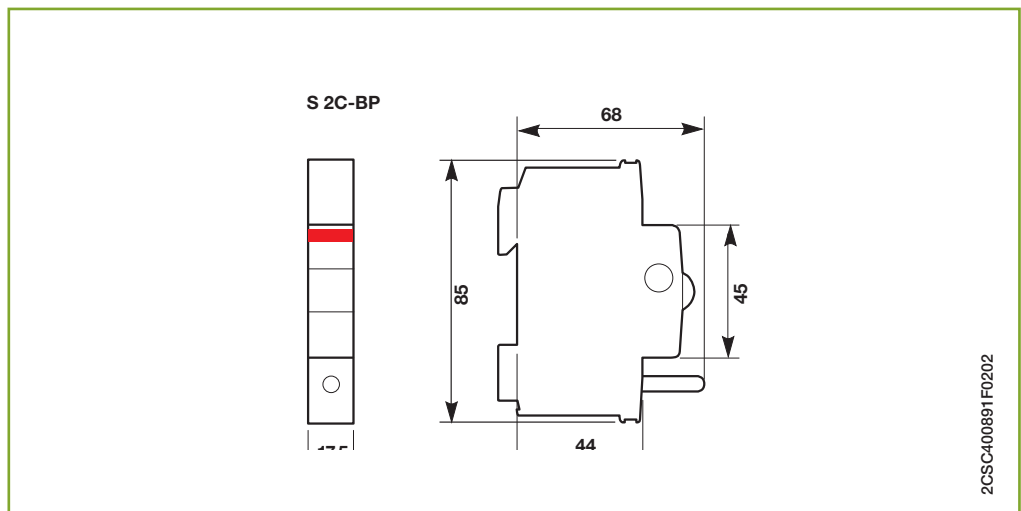



2CSC400248F0001

2CSC400247F0001

2CSC400892F0202

S 2C-CM

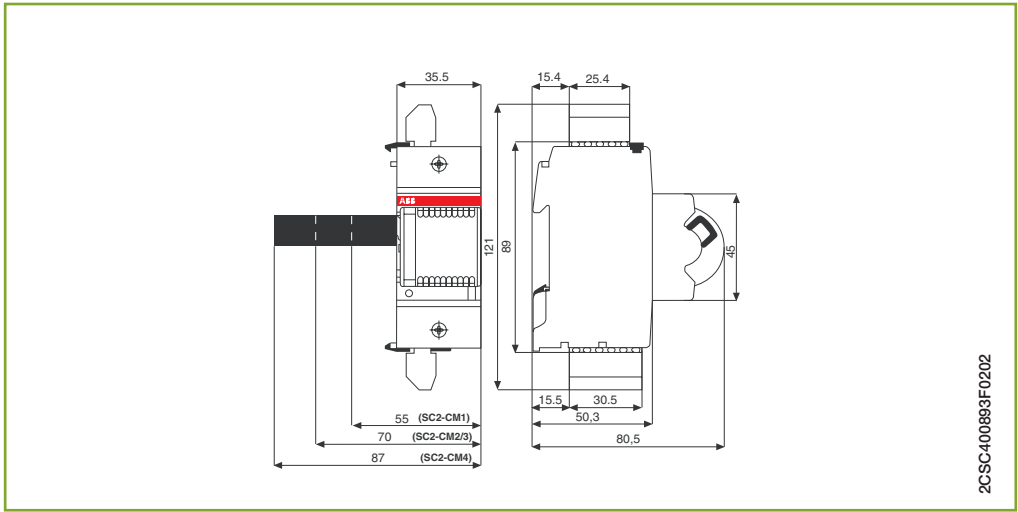

2CSC400893F0202

F2C-ARI, F2C-CM

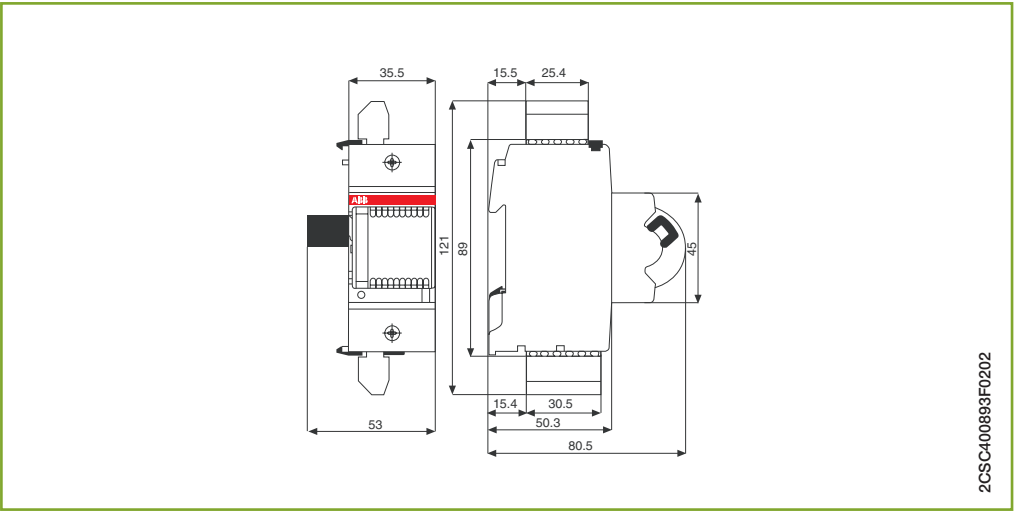

2CSC400893F0202

F2C-ARH, F2C-ARH-T

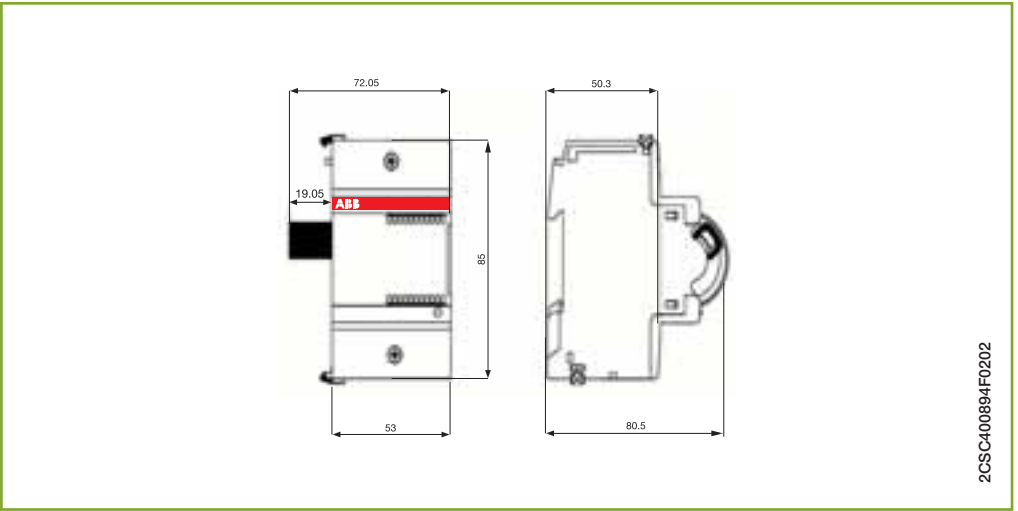

2CSC400894F0202



2CSC400895F0202

MeMo USB data memory

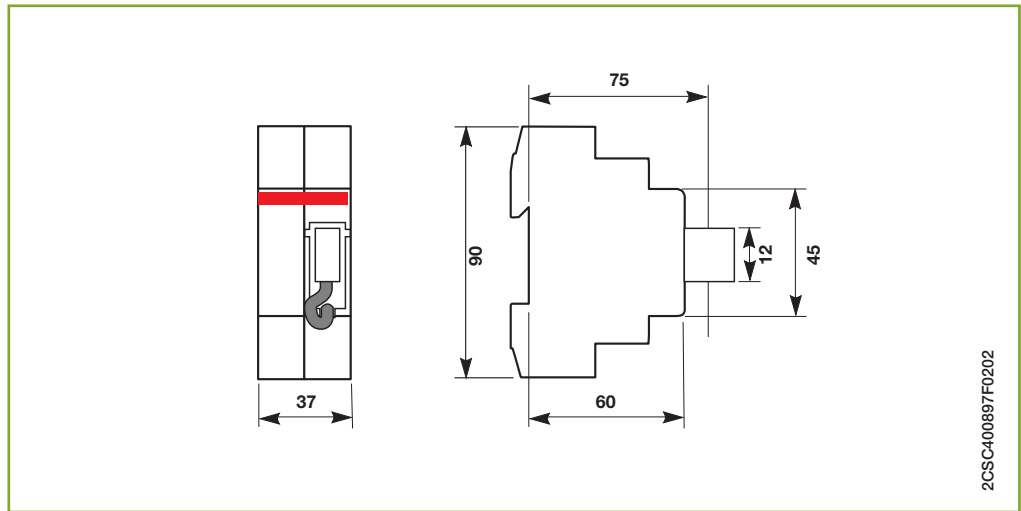

2CSC400897F0202



2CSC400896F0202

Auxiliary elements for SN 201 series

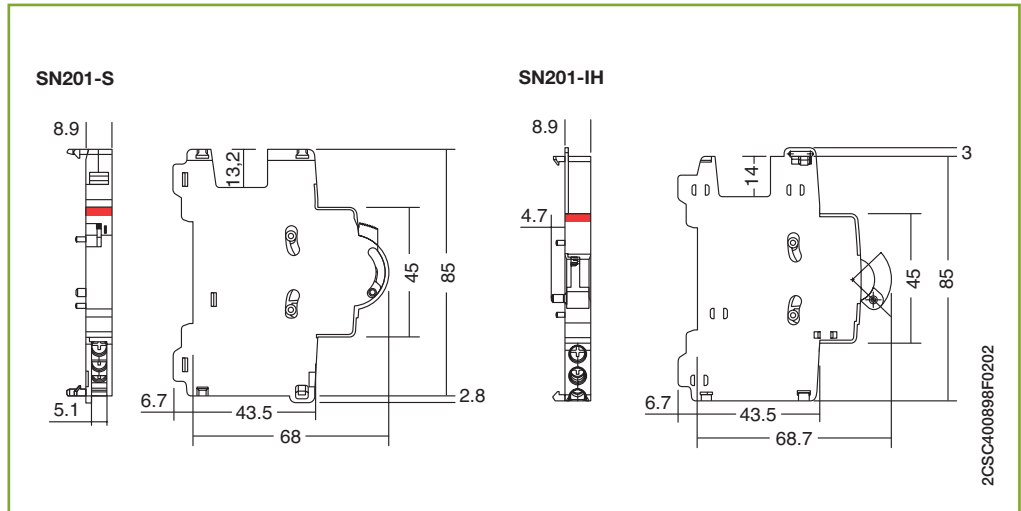

2CSC400898F0202

Auxiliary elements for S 280 and S 290 series



2CSC400499F0201

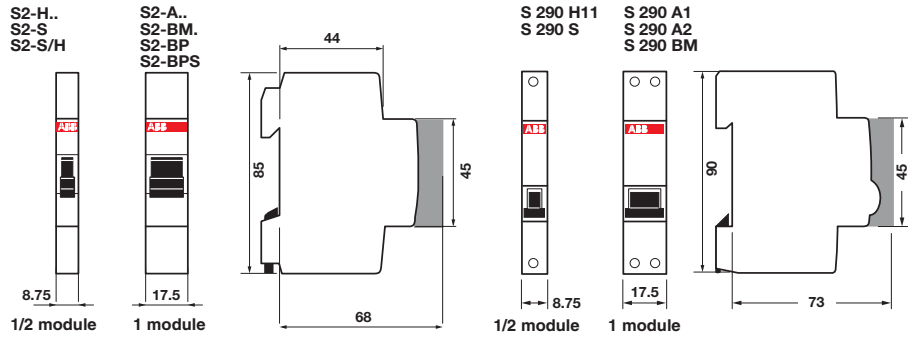

2CSC400899F0202



2CCC413069F0001

S800-AUX, S800-AUX/ALT

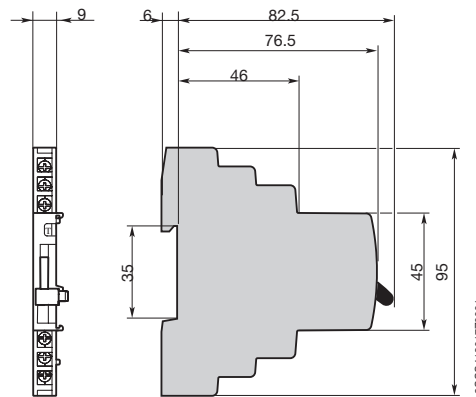

2CCC413017Z0001

2CSC400900F0202



2CSC400025F0202

S800-RSU-H, S500-RSU-H

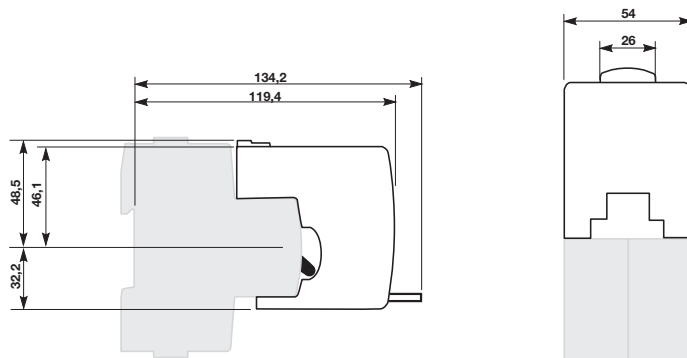

2CSC400901F0202

S800-RD+S800-RHE, S800-NT, S800-BB250, S800-BBPC120

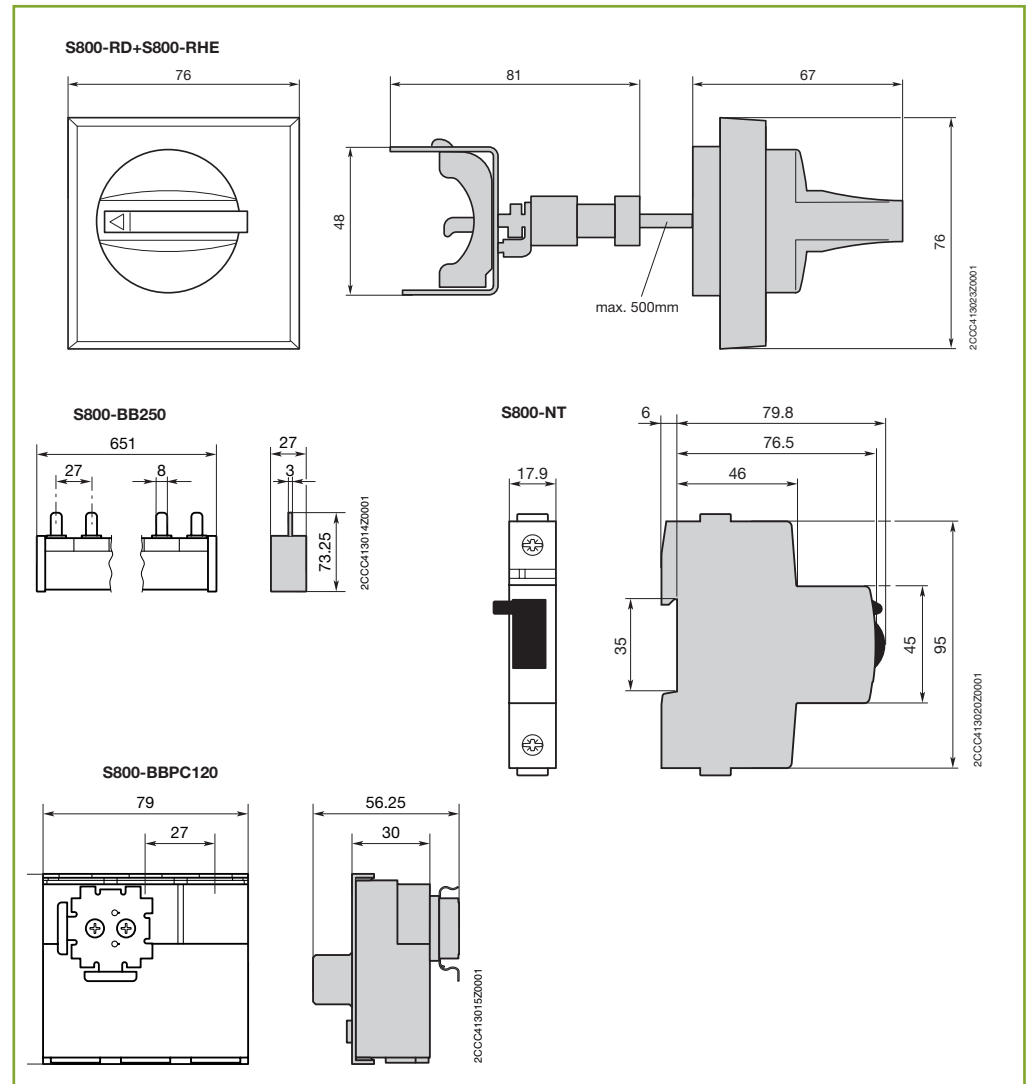
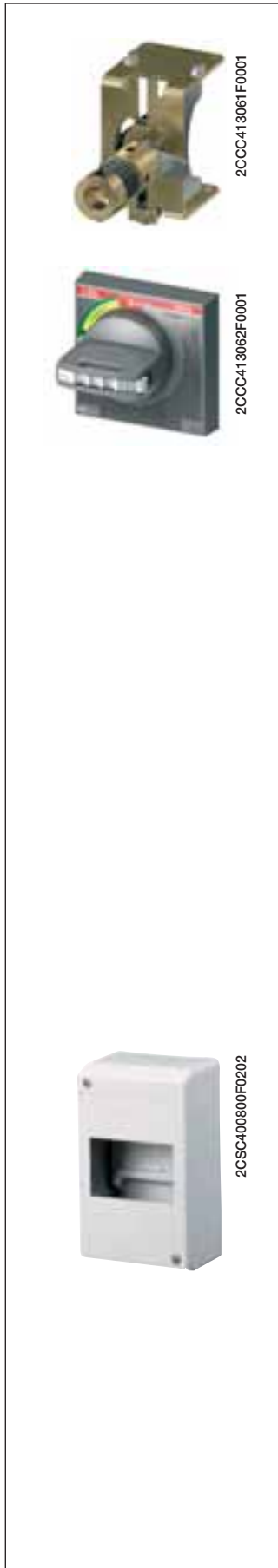

Terminal covers

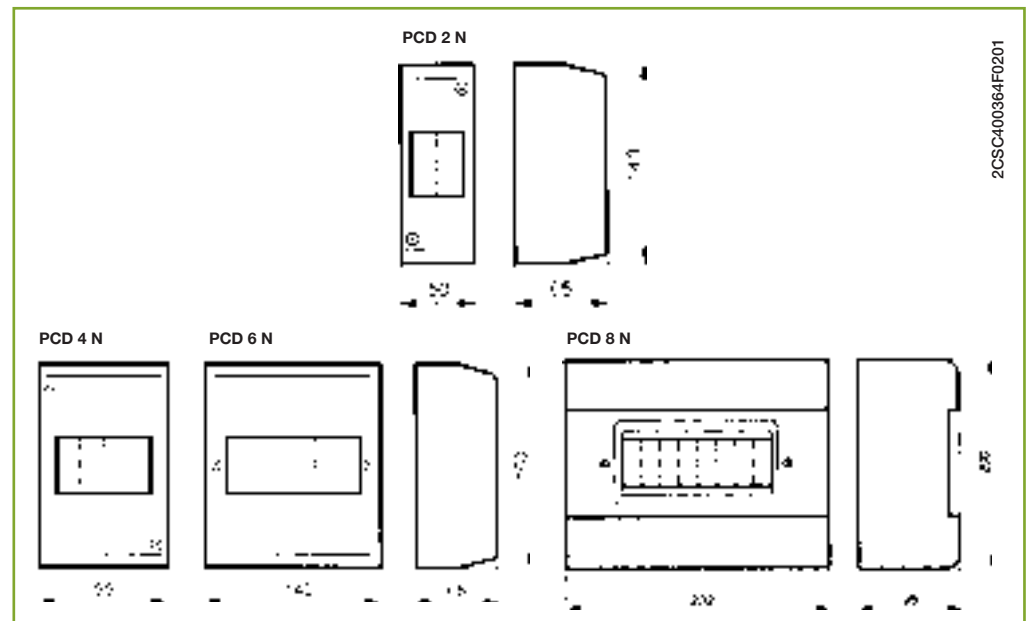

Enclosures of moulded-plastic

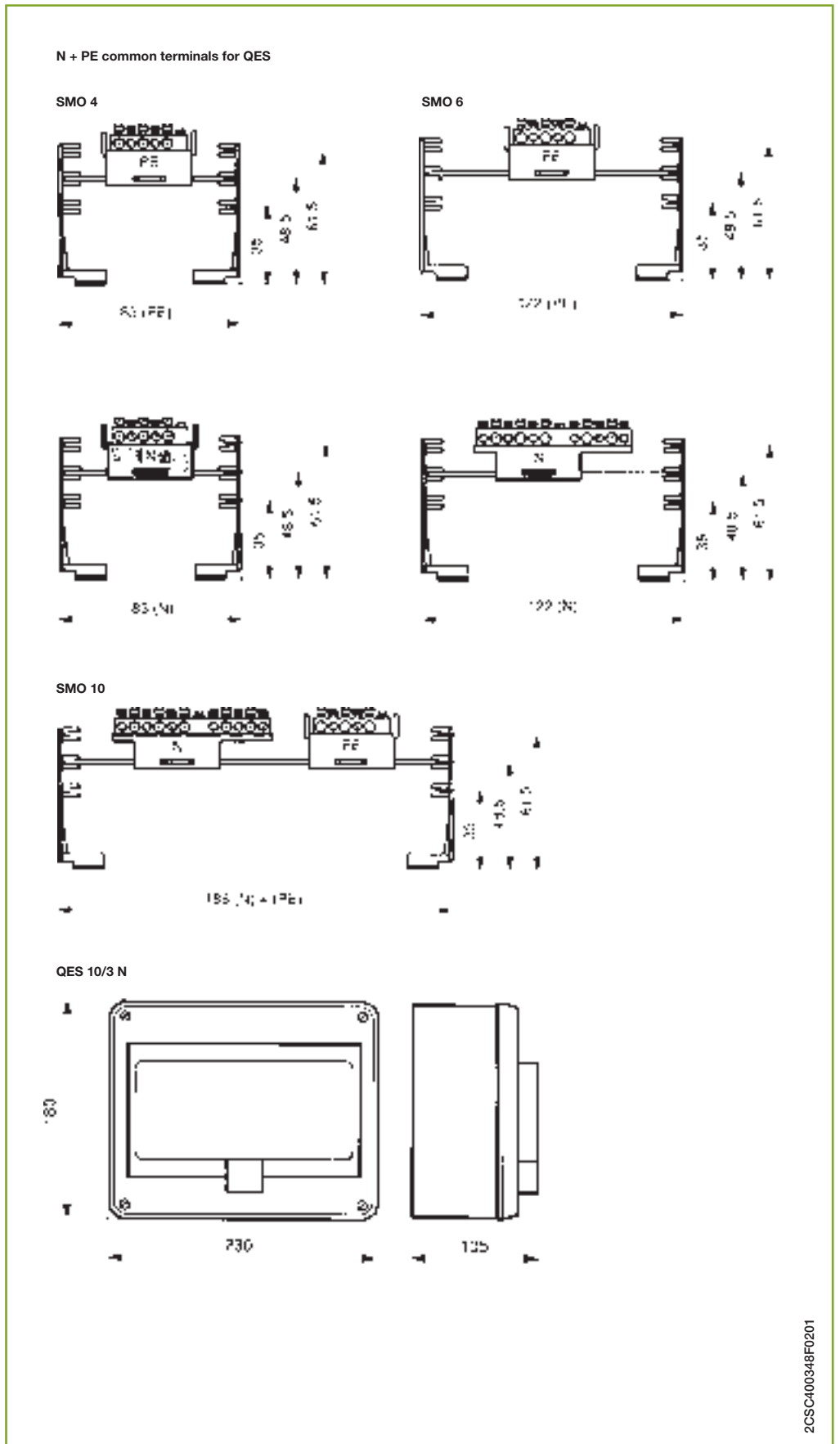

2CSC400348F0201

Flush frame

max 13.5 for insulating cover plate
max 7.5 for metal cover plate

Terminal S 500:K1

Type	Dim. L	Max. No. of modules (1 module=17.5 mm)
S 500 - ME 1	38 mm	for 2 module
S 500 - ME 2	88 mm	for 5 module
S 500 - ME 3	184 mm	for 10 module

Drill holes

Mounting rails

① In the case of DSW 1, the drill holes are vertical

Name	A	A1
DSW	17.5	15
DSW 2	35	20
DSW 3	52.5	37.5
DSW 4	70	55
DSW 6	105	90

2CSC400363F0201

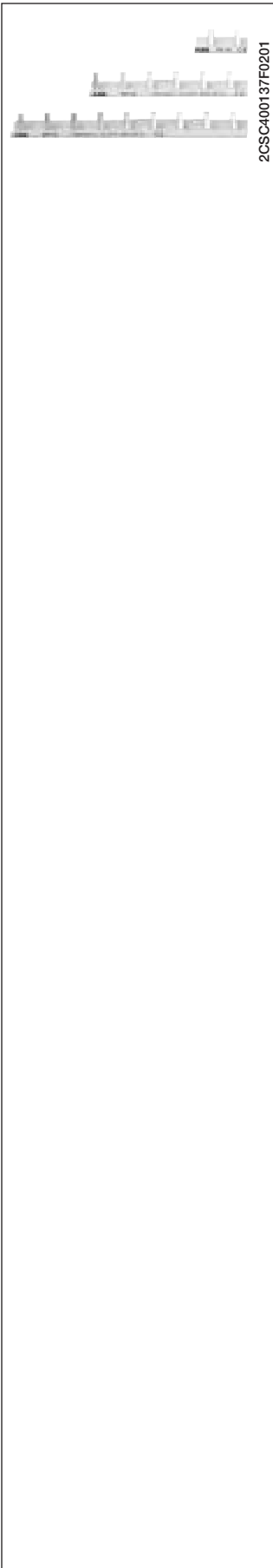

Busbars

PS 1/2

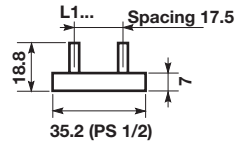

PS 1/6

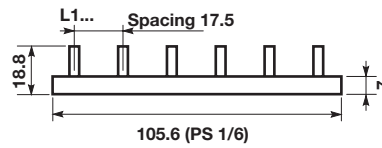

PS 1/9

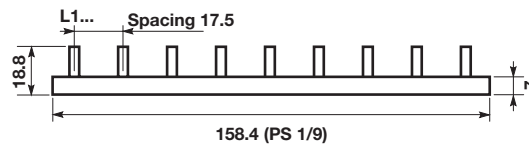

PS 1/12

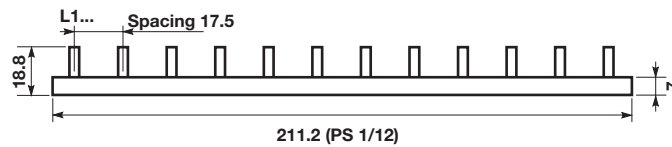

PS 3/60

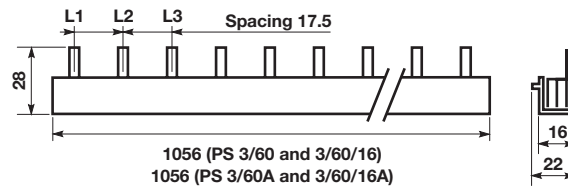

Auxiliary contact bridge HKB

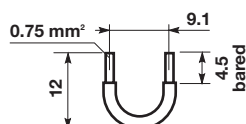

2CSC400902F0202

PS 3/6

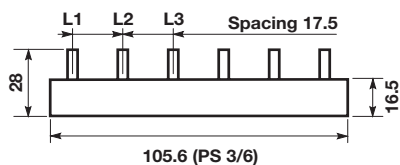

PS 3/9

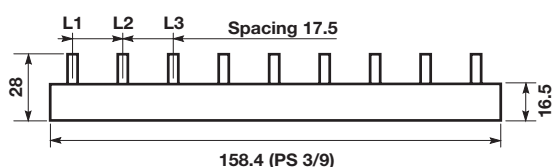

PS 3/12 (2CDL 230 001 R1012)

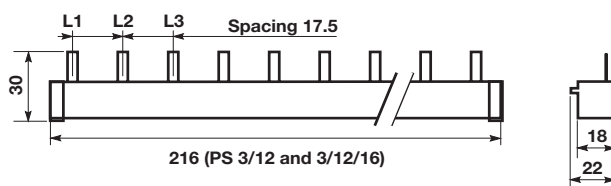

PS 3/12 FI (2CDL 230 002 R1012)

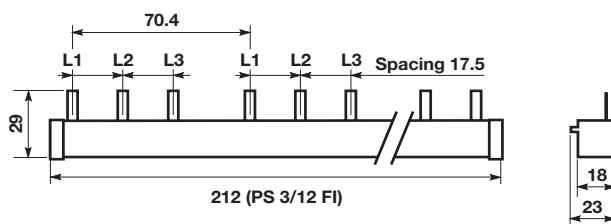

2CSC400903F0202

PS 2/12

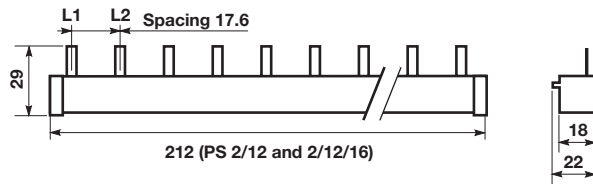

PS 2/58

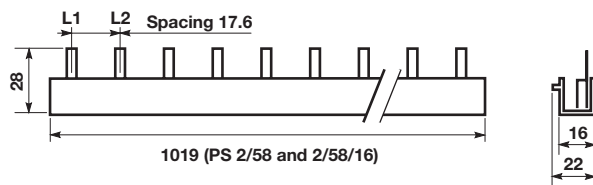

PS 2/48

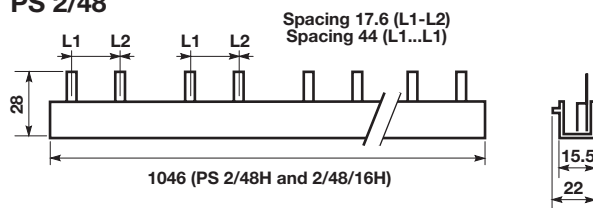

PS 3/39H

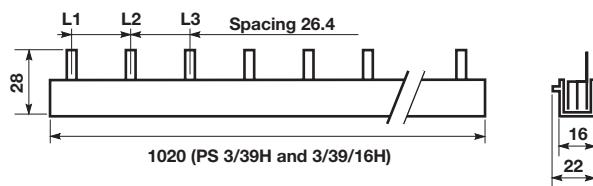

PS 3/48H

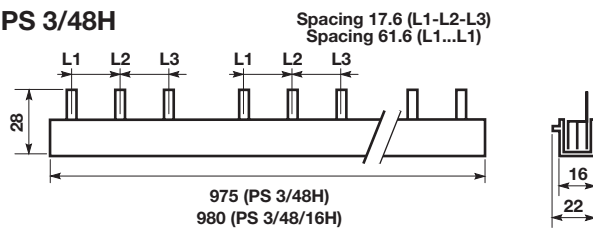

PS 3/12 FI H

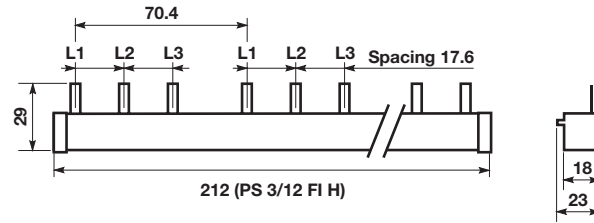

PS 4/12

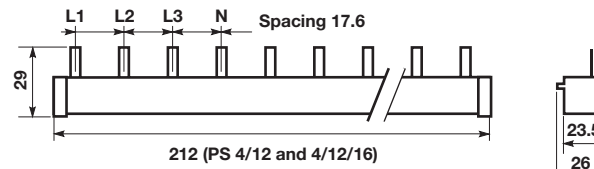

PS 4/60

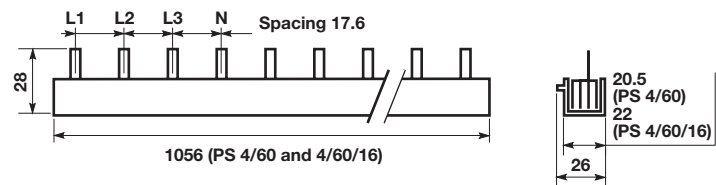

PS 4/58 N

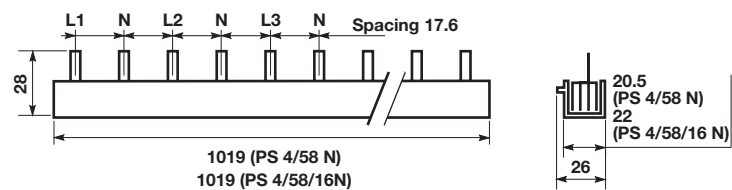

PS 3/12 E 463

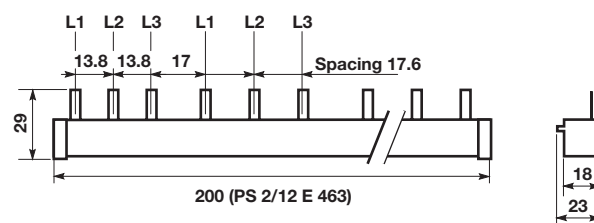

2CSC400905F0202

ME flange for rear board mounting

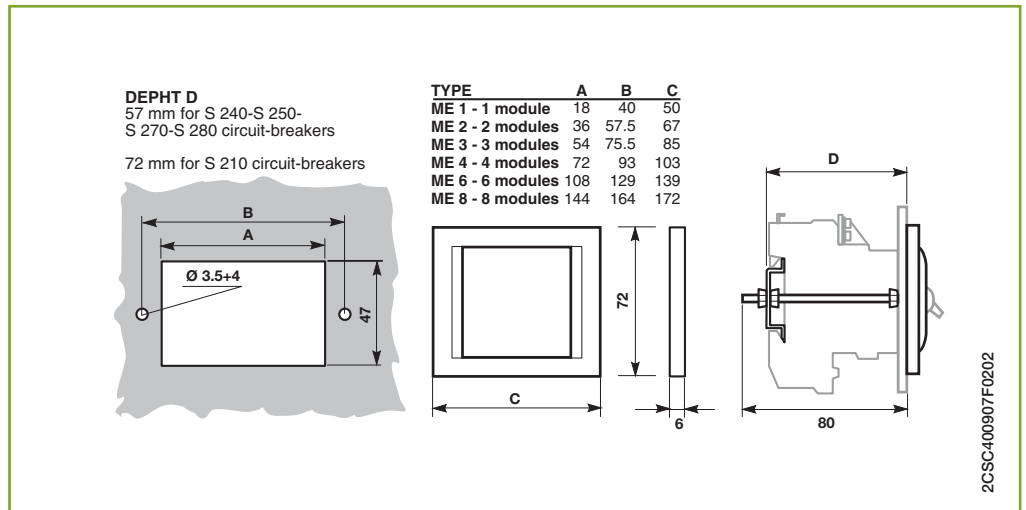

OH_2A

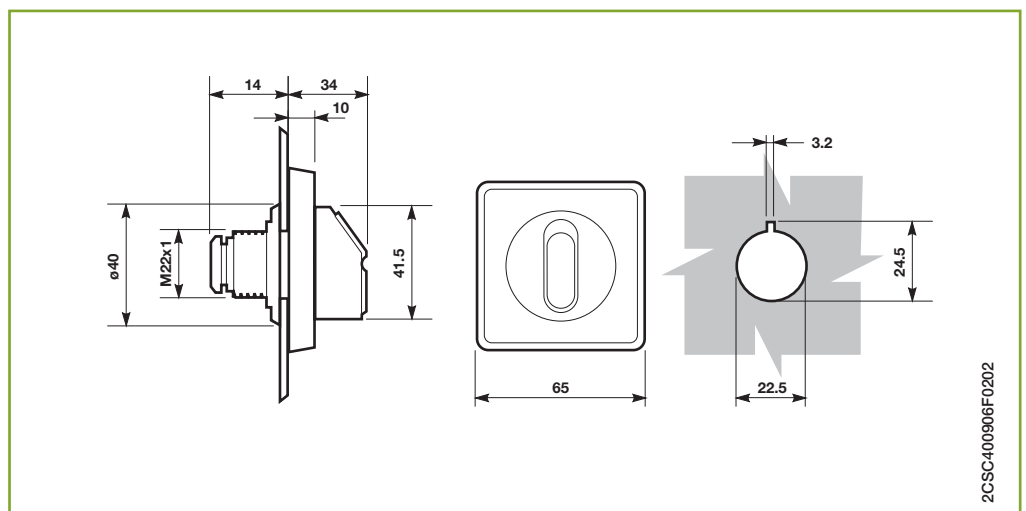



2CSC400313F0201

Type 1 Surge Protective Devices

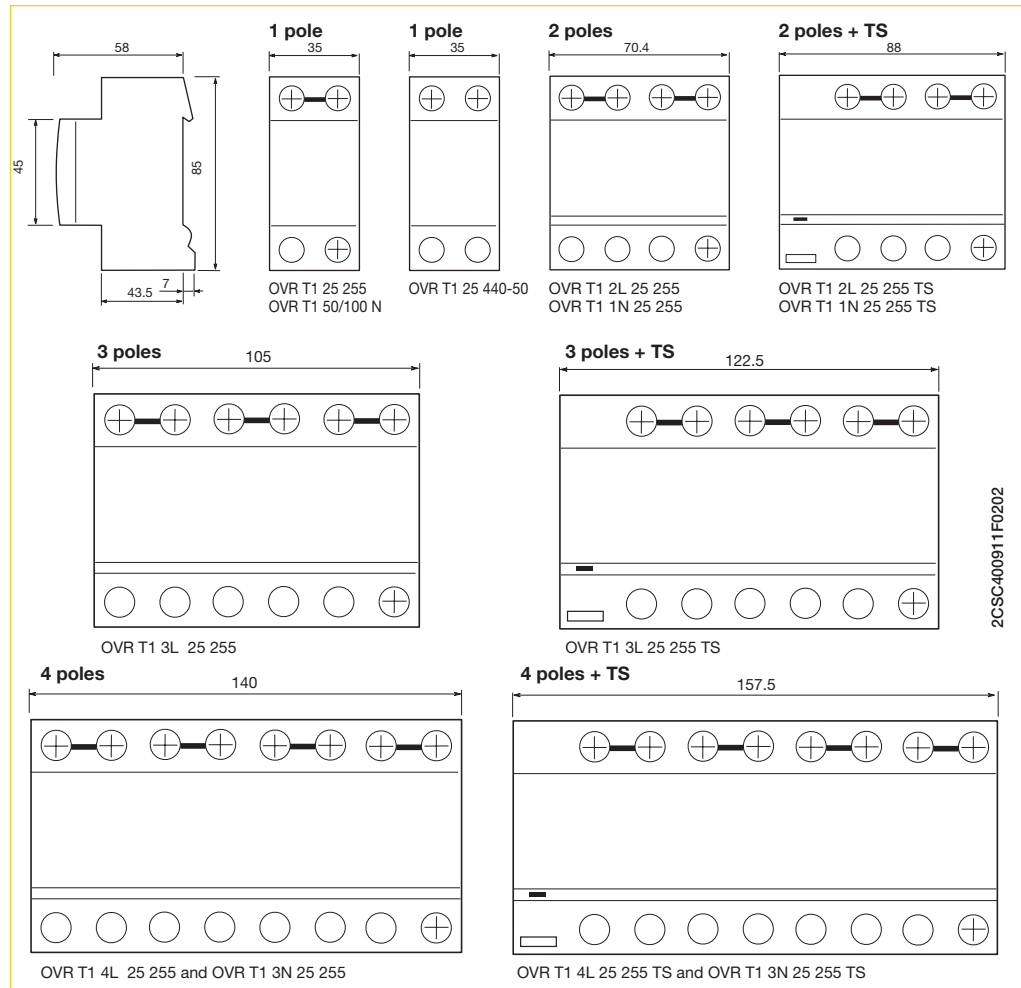

2CSC400300F0201

Type 1+2 Surge Protective Devices

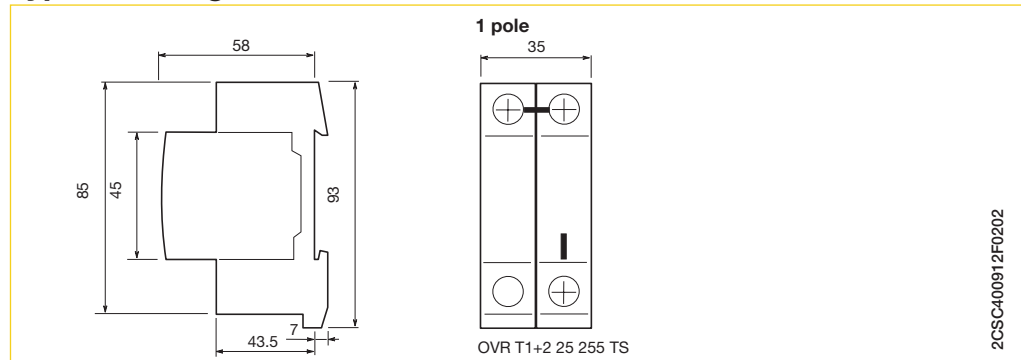

2CSC400910F0202

Type 1 & Type 1+2 Surge Protective Devices

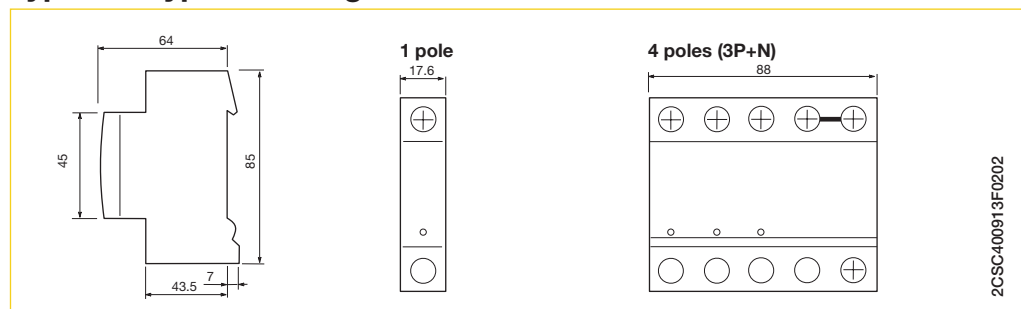



2CSC400302F0201

Type 1 + 2 / Type 2 Surge Protective Devices

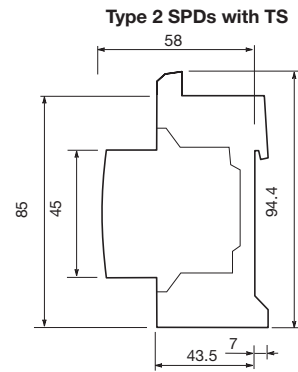
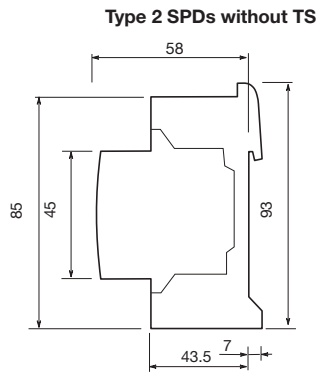

2CSC400915F0202

1 pole



OVR TC 6V P

1 pole



OVR T2 15
OVR T2 40
OVR T2 70
OVR T1+2 7 275s P

2 poles (1P+N)

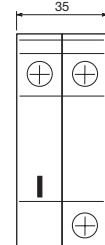

OVR T2 1N 15
OVR T2 1N 40
OVR T2 1N 70
OVR T1+2 1N 7 275s P

3 poles

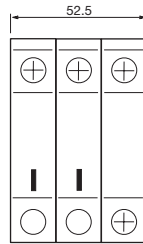

OVR PV 40 600
OVR PV 40 1000

3 poles

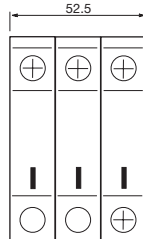

OVR T2 3L 15
OVR T2 3L 40
OVR T2 3L 70
OVR T1+2 3L 7 275s P

4 poles (4P+0)

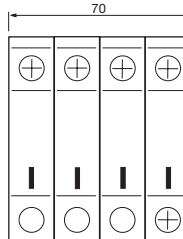

OVR T2 4L 15
OVR T2 4L 40
OVR T2 4L 70
OVR T1+2 4L 7 275s P

3 poles (3P+N)

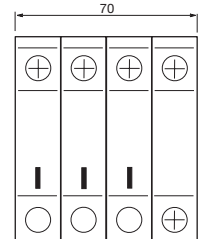

OVR T2 3N 15
OVR T2 3N 40
OVR T2 3N 70
OVR T1+2 7 275s P



2CSC400916F0202

E 90 fuse disconnectors and E 90h fuse holders

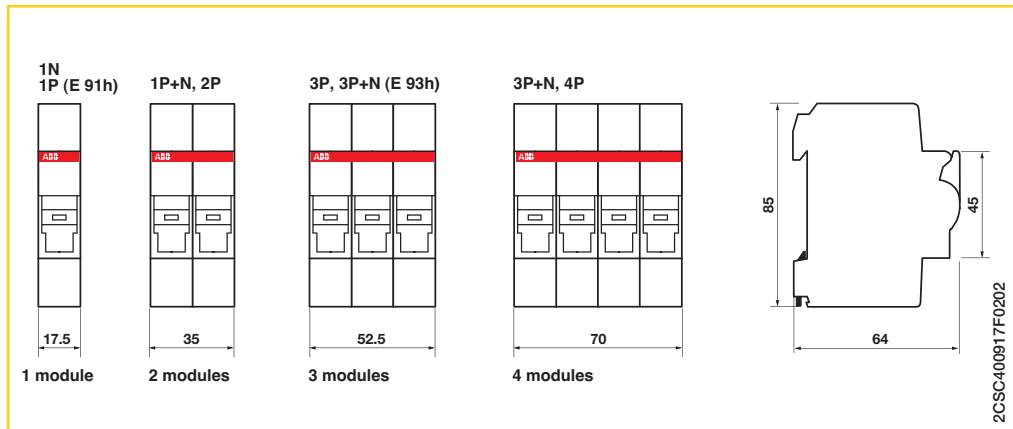

2CSC400212F0201

E 930 fuse disconnectors

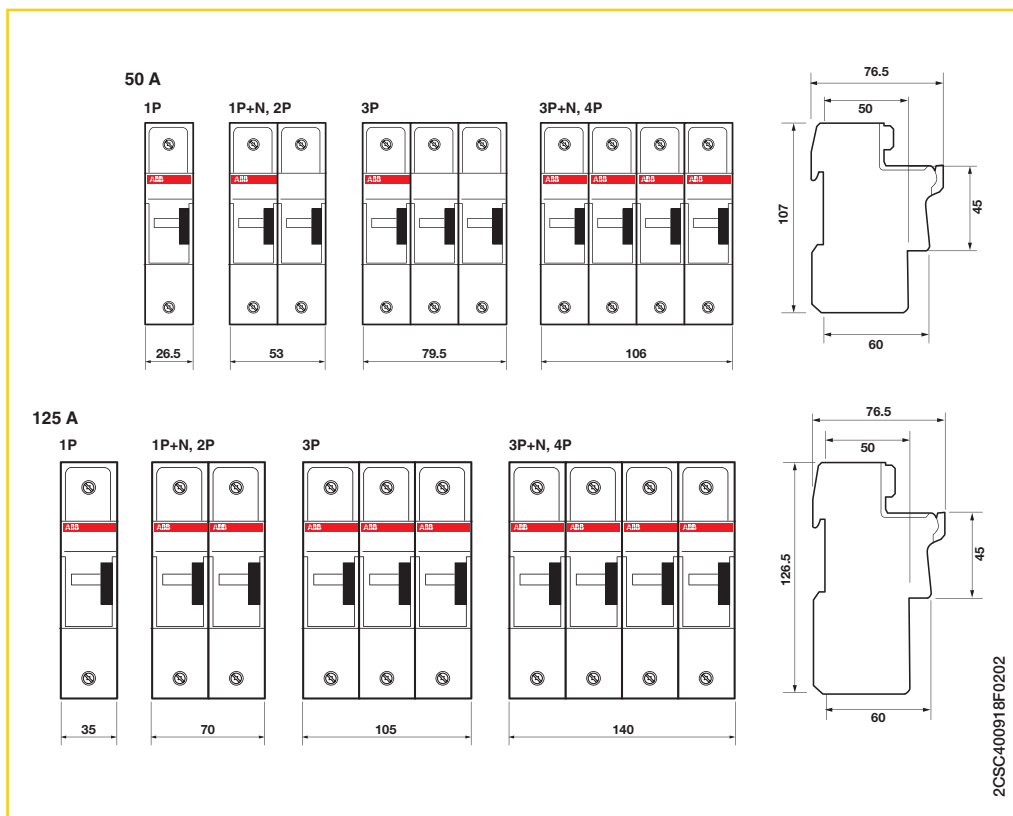

2CDC051001S0010

EPD 24

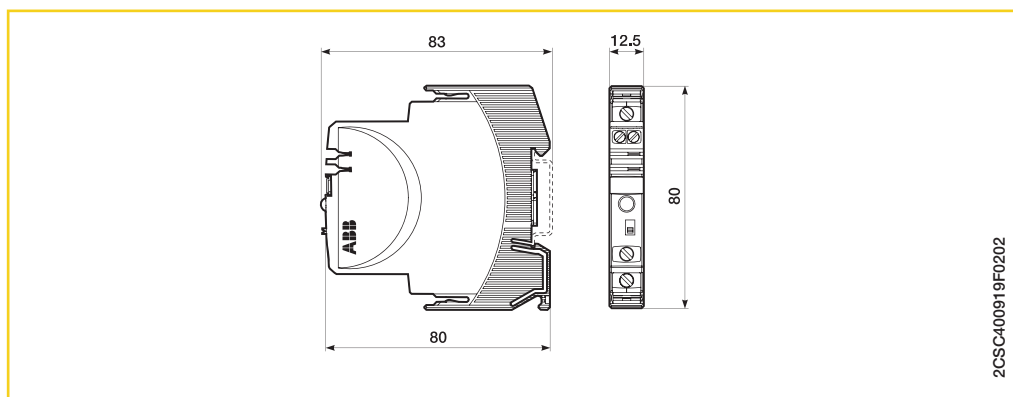



2CDC051105F0007

ILTS - ILTS-E switch-disconnectors

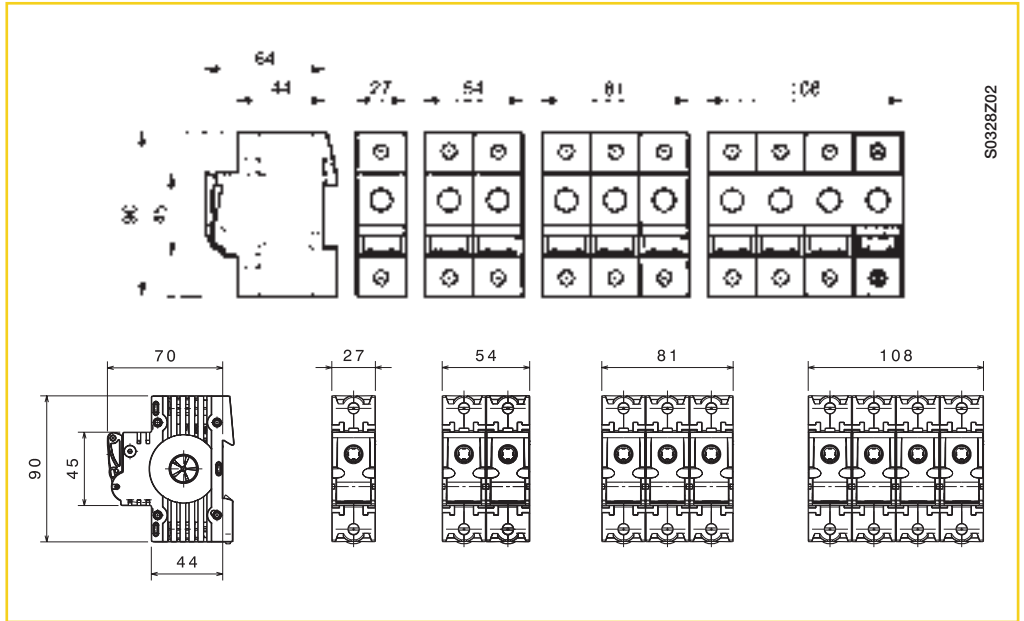

2CSC400920F0202

Isoltester-DIG-RZ/PLUS

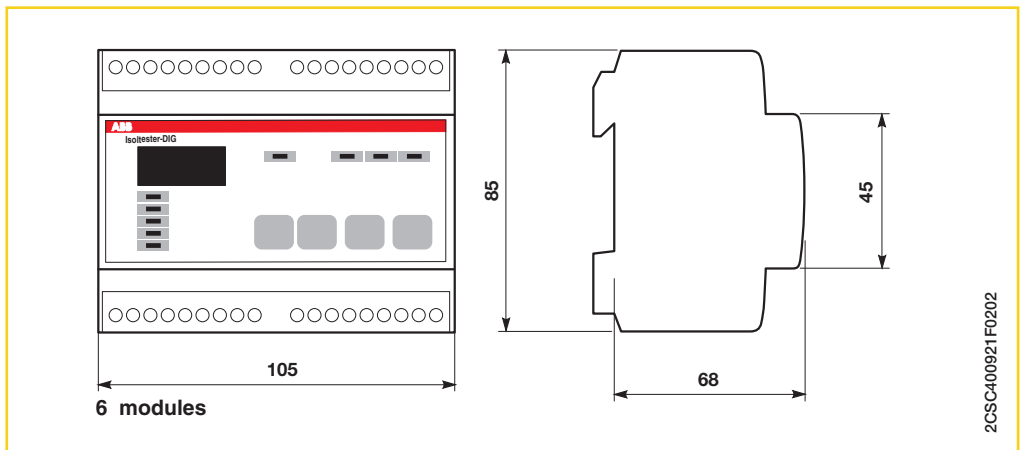

2CSC400404F0201

Selvtester-24

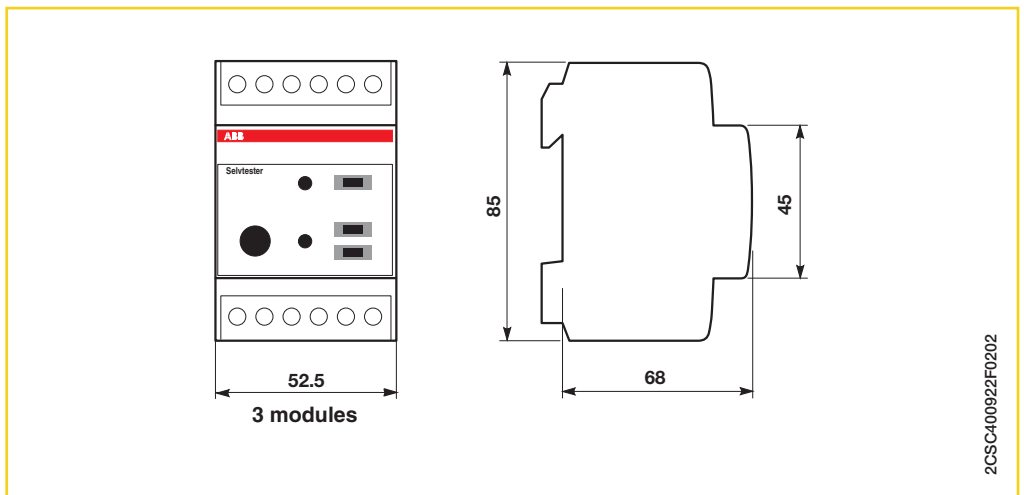

QSD remote signalling panels



2CSC400923F0202

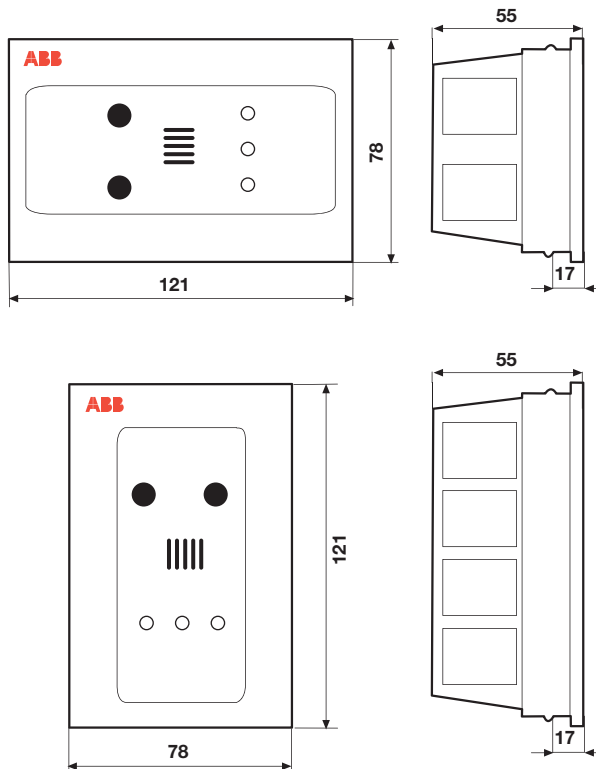

2CSC400925F0202

ISL industrial insulation monitoring devices



2CSC400924F0202

ISL-A 115
ISL-A 230
ISL-A 600
ISL-C 600

ISL-A 24-28
ISL-C 230
ISL-C 440
ISL-MOT 1000

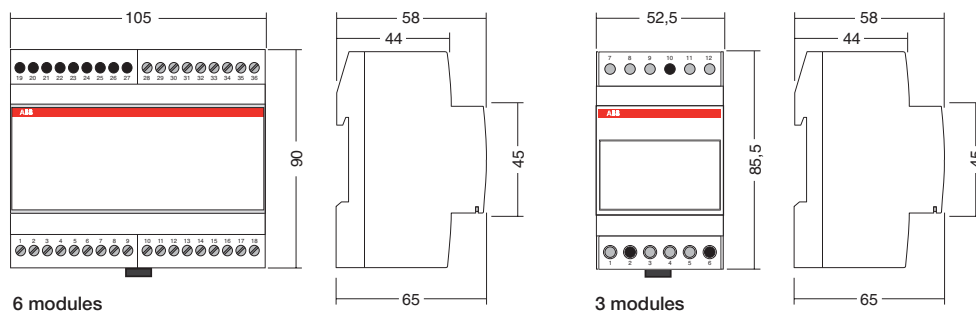

2CSC400926F0202



2CSC400927F0202

TI insulating transformers

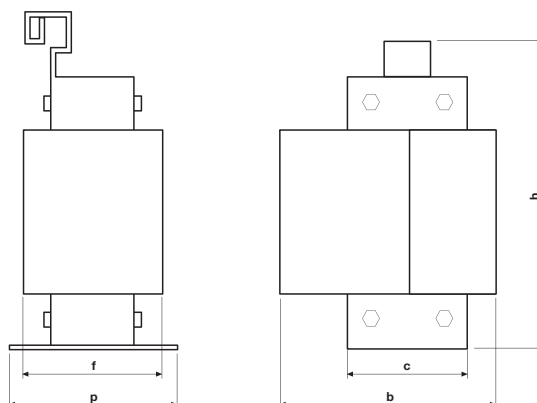

Dimensions	Rated output [KVA]			
	3	5	7,5	10
b [mm]	205	240	240	277
c [mm]	170	170	170	176
f [mm]	115	115	115	173
h [mm]	340	380	380	380
p [mm]	150	150	160	203
Weight [kg]	29,5	44	50,5	73

2CSC400929F0202



2CSC400928F0202

QSO electrical switchboard for medical locations

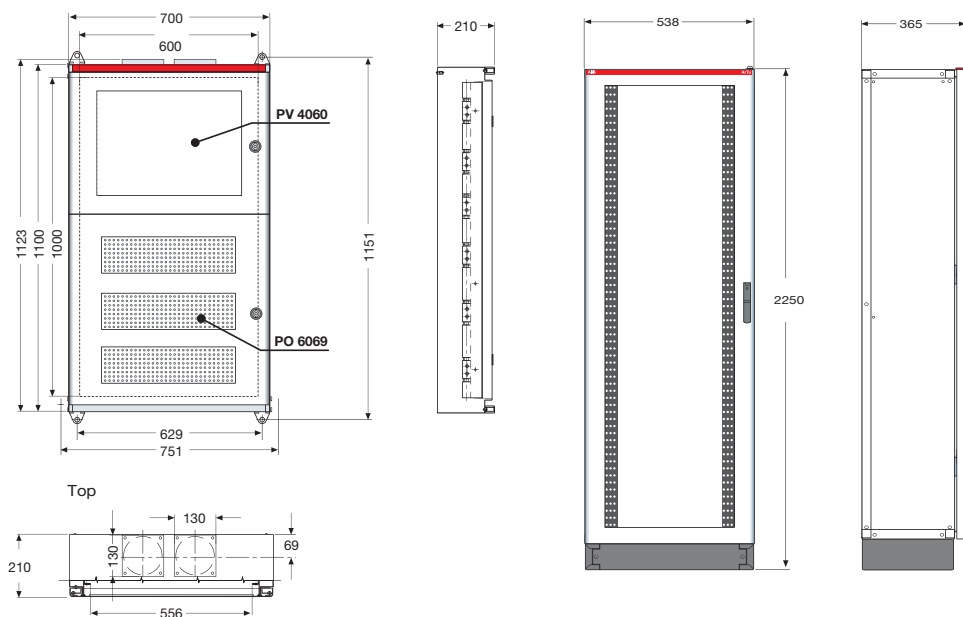

2CSC400930F0202



2CSC400070F0201

E 200 switches

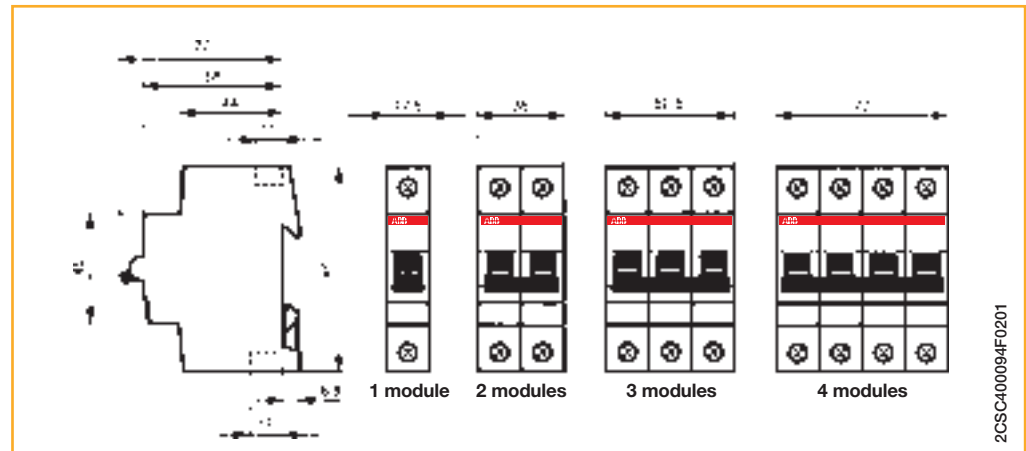

2CSC400094F0201



2CSC400458F0201

E 463/3-KB, E 480/-KB, E 463/3-SL switches

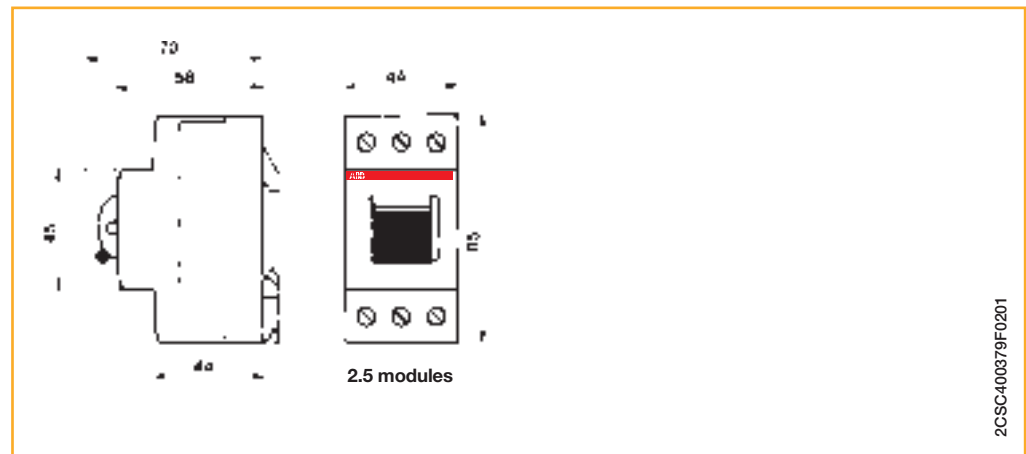

2CSC400379F0201



2CCC441020F0001

E 210 switches, pushbuttons and indicator lamps

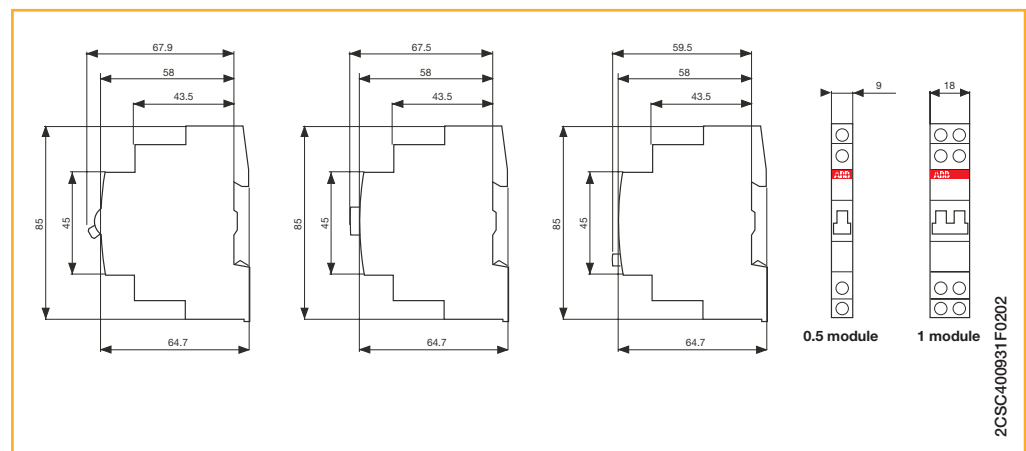

2CSC400931F0202



2CSC445165F0001

SL luminous indicators for panel installation

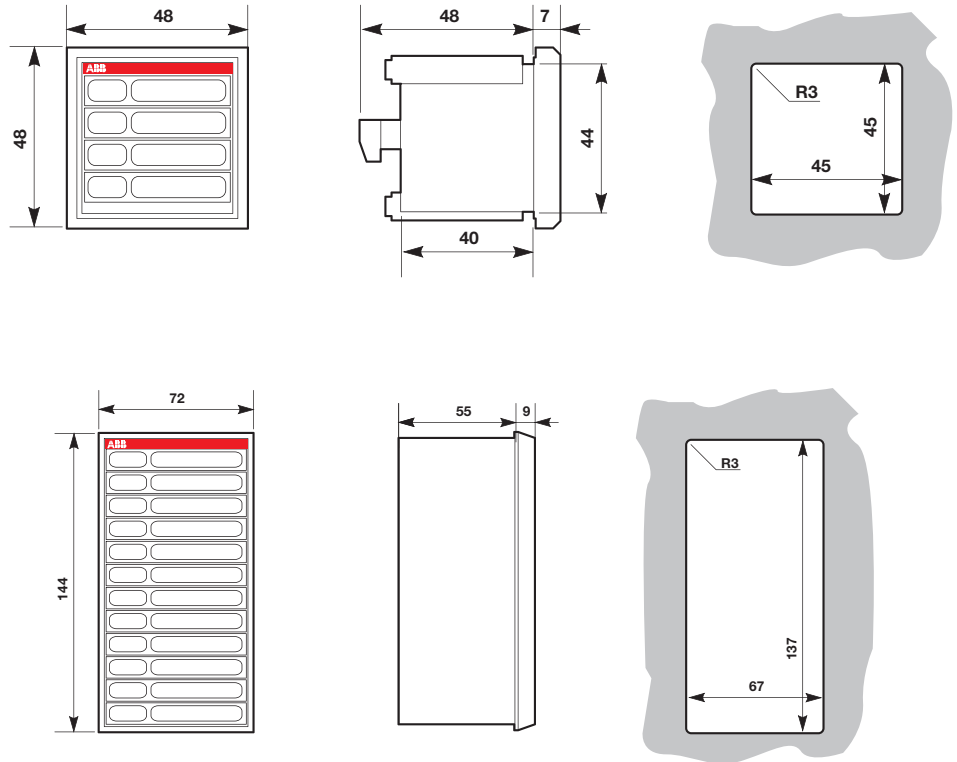

2CSC400932F0202



2CSC400479F0001

ESB/EN contactors

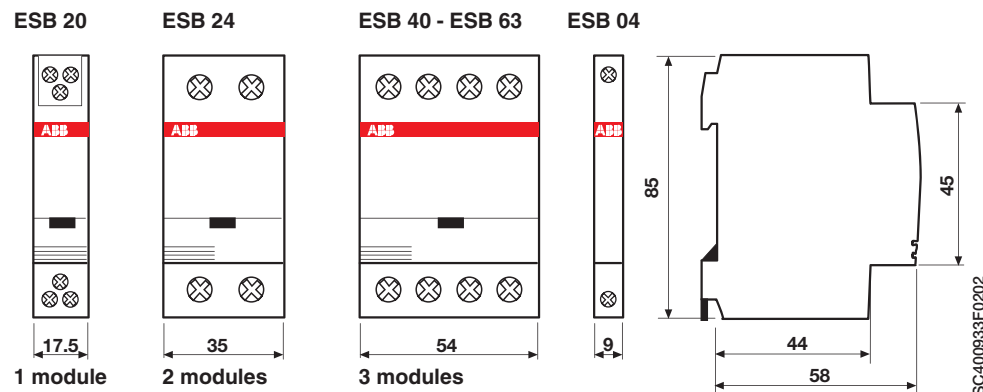

2CSC400933F0202



2CSC400069F0201

E 259 installation relays

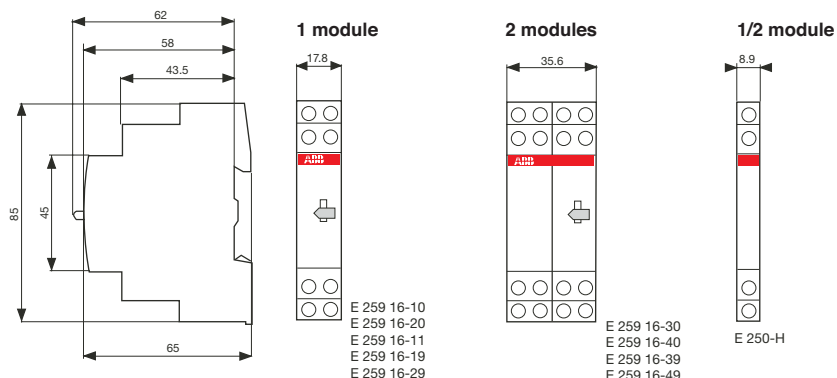

2CSC400935F0202



2CSC400068F0201

E 250 latching relays

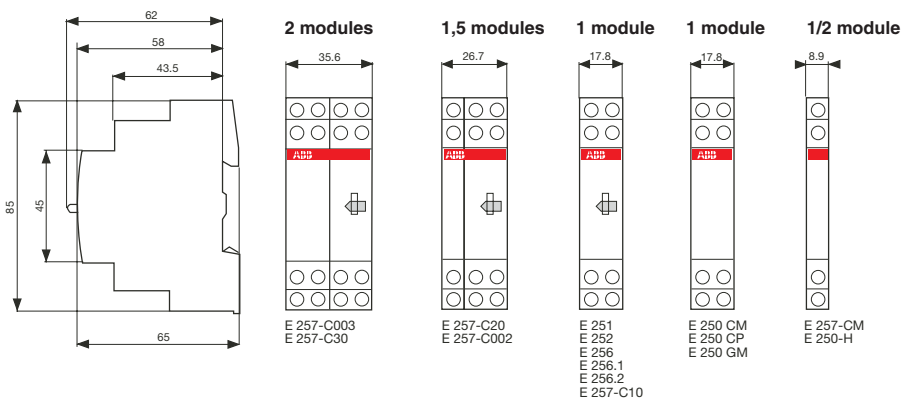

2CSC400936F0202



2CSC400934F0202

FLR pulse relays

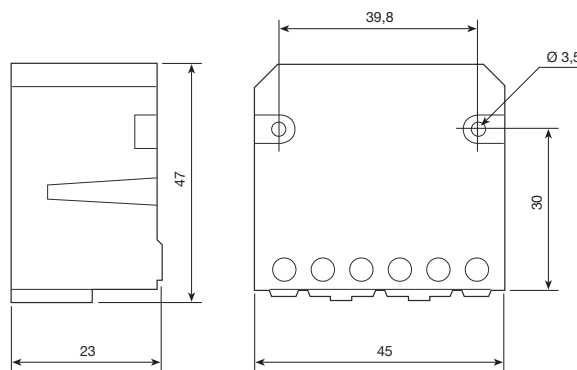

2CSC400937F0202



2CSC400066F0201

E 260 latching relays

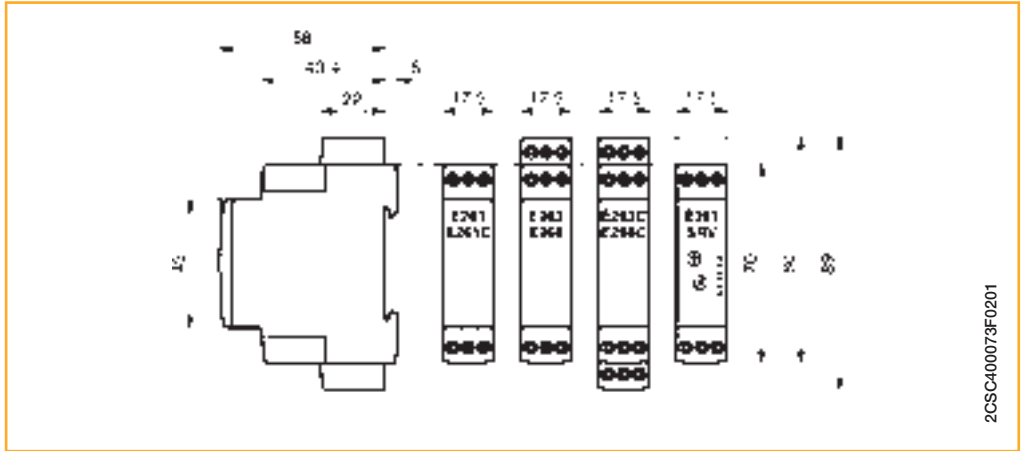

2CSC400073F0201



2CSC400432F0201

STD dimmers

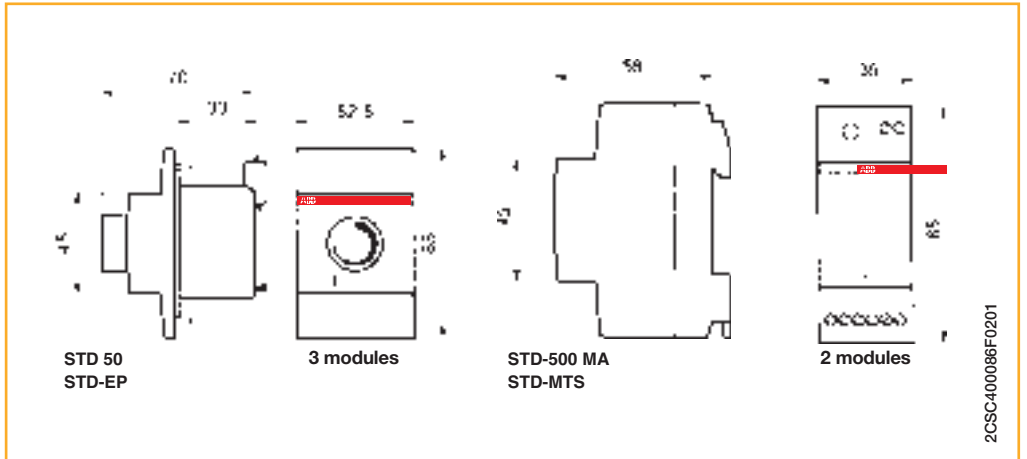

2CSC400086F0201



2CDC251089F0b06

E 234 CT-D electronic timers

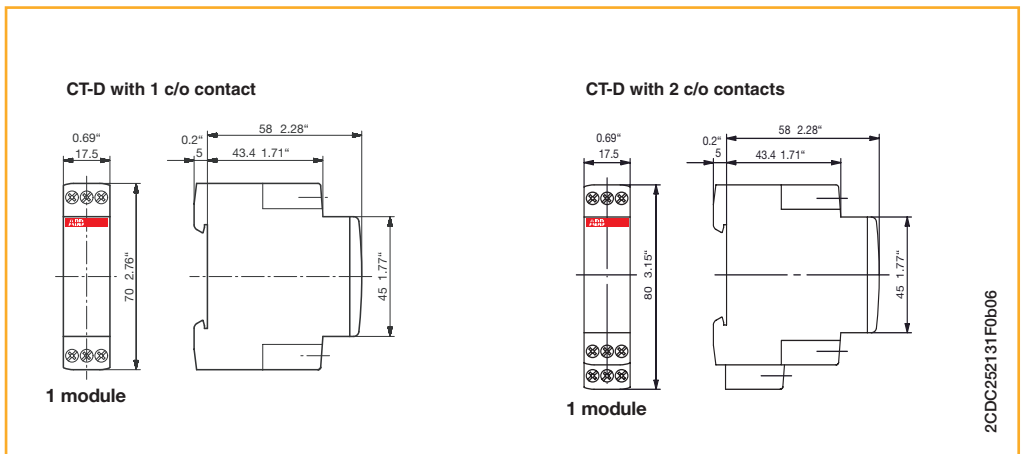

2CDC252131F0b06



2CSC400938F0202

AT electro-mechanical time switches

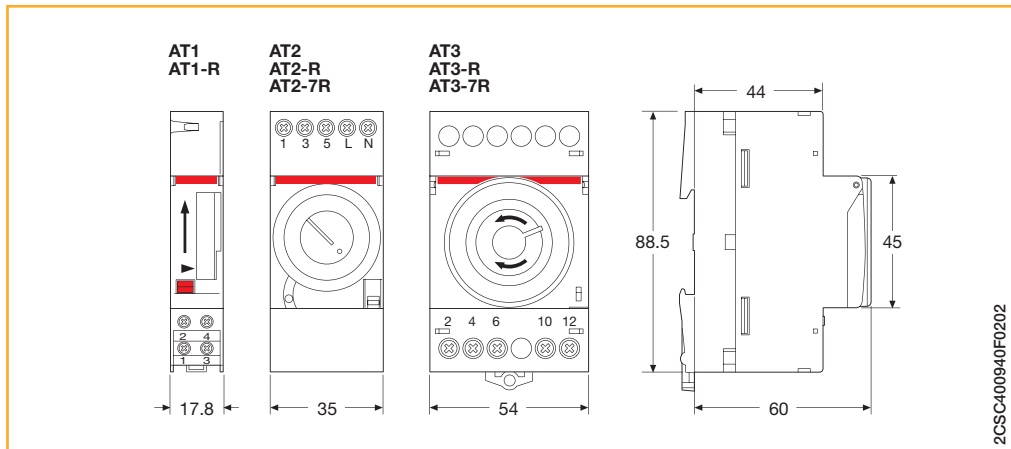

2CSC400939F0202

D Line digital time switches

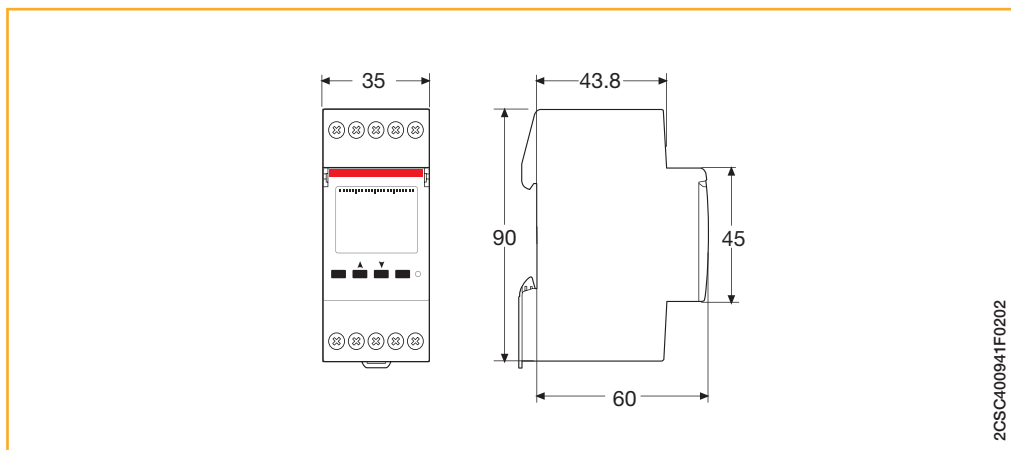



DTS digital time switches

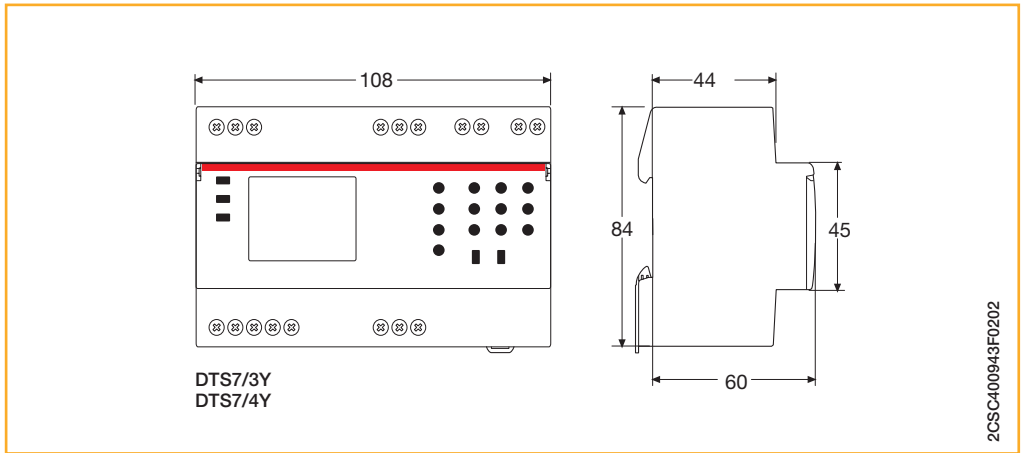

E 232 staircase lighting time delay relays

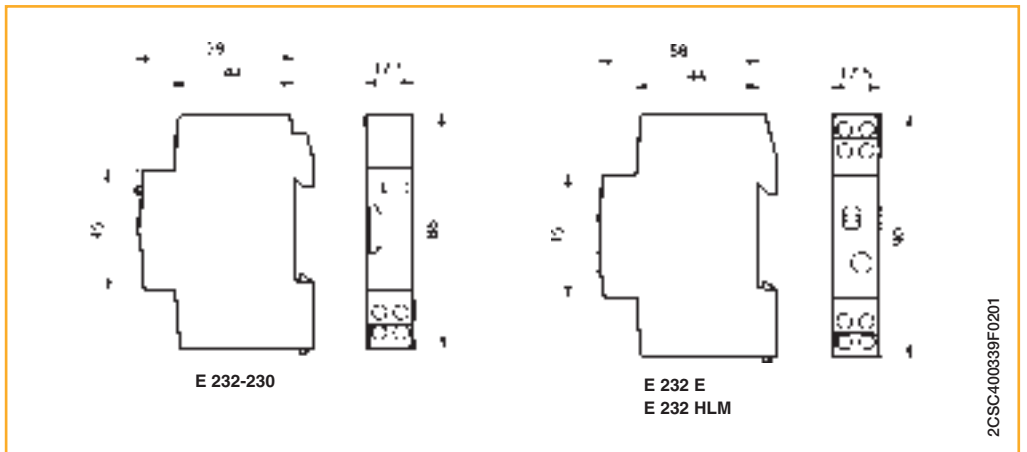

THS modular thermostats

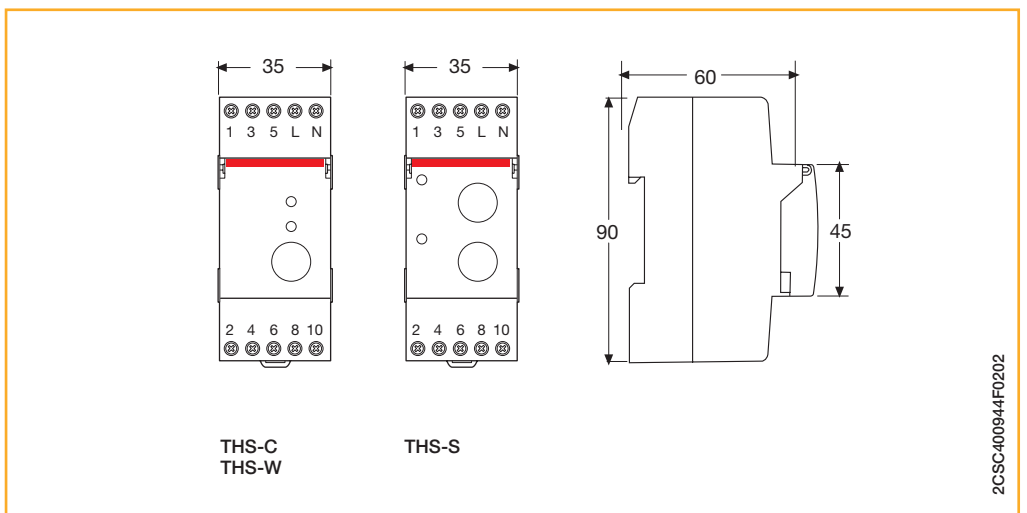

TW twilight switches



2CSC400945F0202



2CSC400946F0202

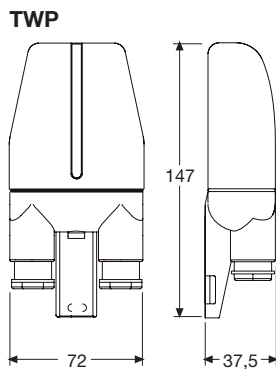
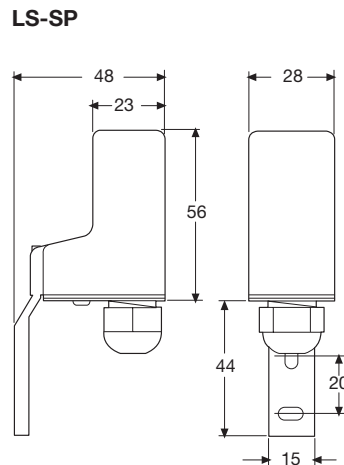
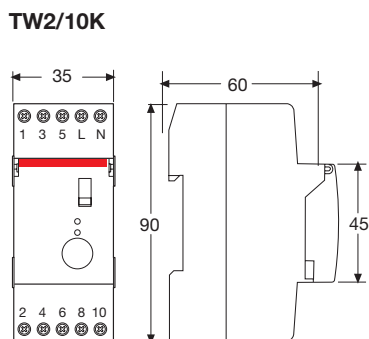
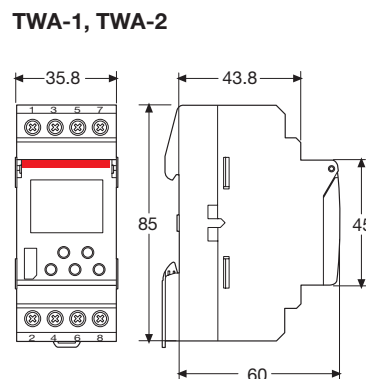
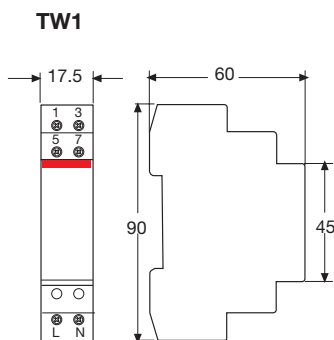

2CSC400947F0202

ATT GSM modules



2CSC400948F0202

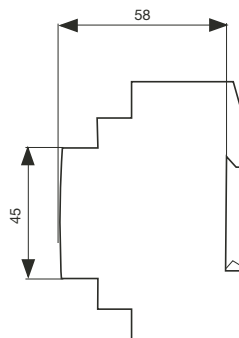
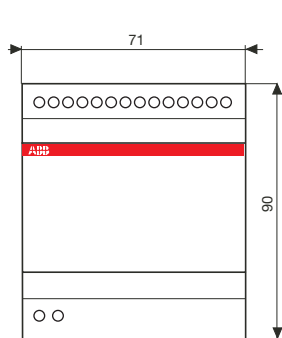

2CSC400949F0202



2CDC311034F0b06

CL logic relays

CL-LSR, CL-LST

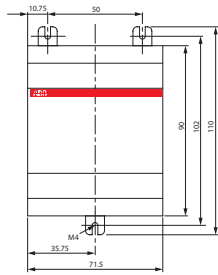

CL-LMR, CL-LMT

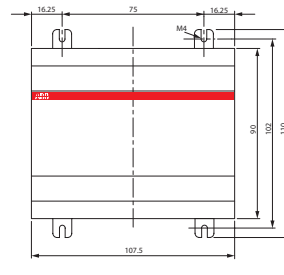

CL-LER.20

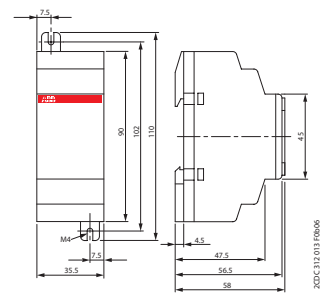

CL-LDD.K + CL-LDC.L... +
(CL-LDR or CL-LDT)

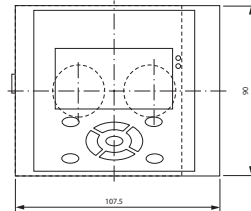

CL-LDD

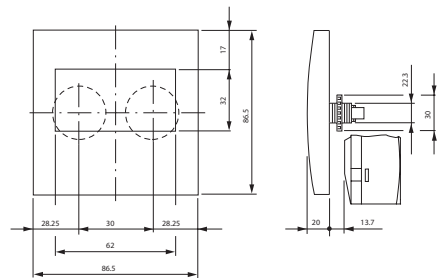

2CDC311201F0b06

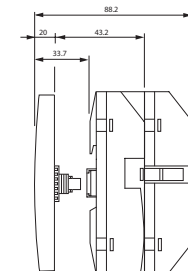

2CDC311014F0b06

CL-LDR, CL-LDT

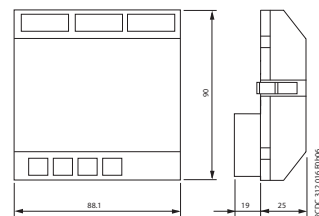

2CDC311201F0b06

CL-LDC.S..

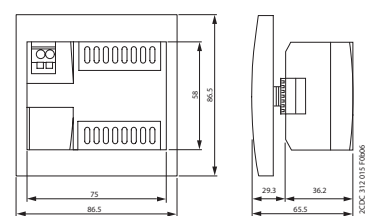

2CDC311015F0b06

2CDC312011F0b06



2CSC400457F0201

E 450 priority switches

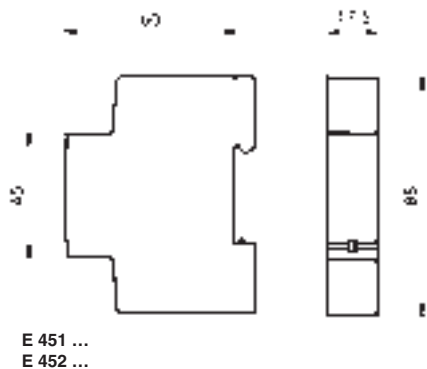

2CSC400084F0201



2CSC400510F0201

RAL overload alarms

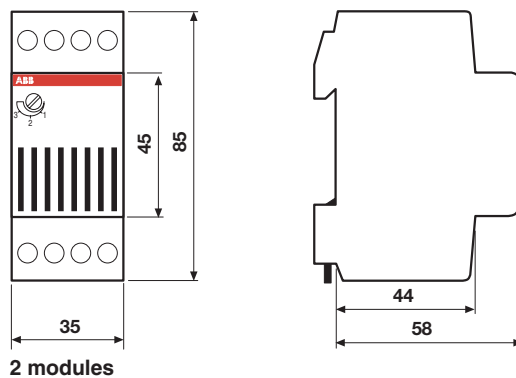

2CSC400950F0202



2CSC400511F0201

LSS1/2 load shedding switches

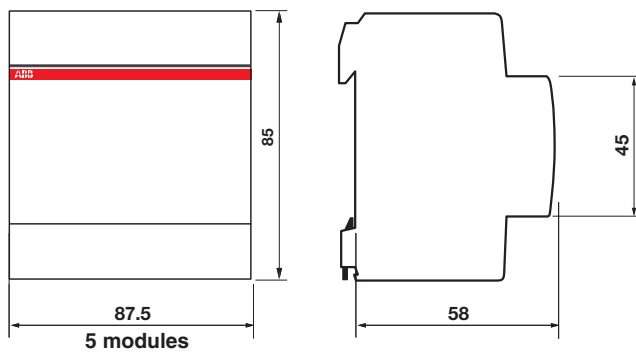

2CSC400951F0202



2CSC400466F0201

E 235 mains disconnection relays

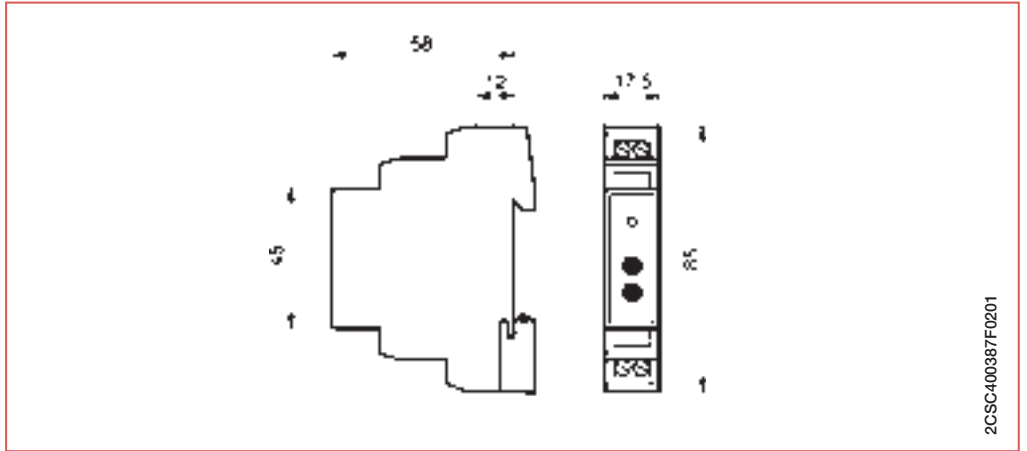

2CSC400387F0201



2CSC400515F0201

SQZ3 phase and sequence relays

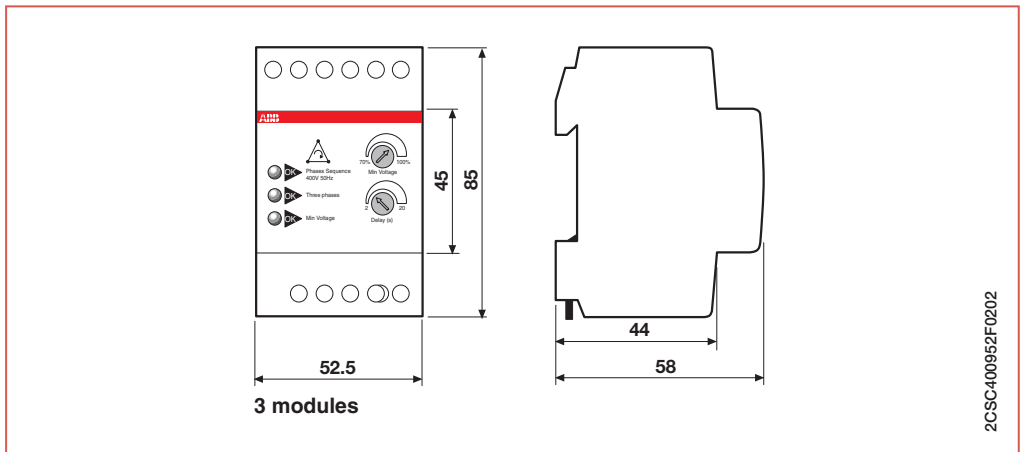

2CSC400952F0202



2CSC400513F0201

Max./min. current/voltage ammetric and voltmetric relays

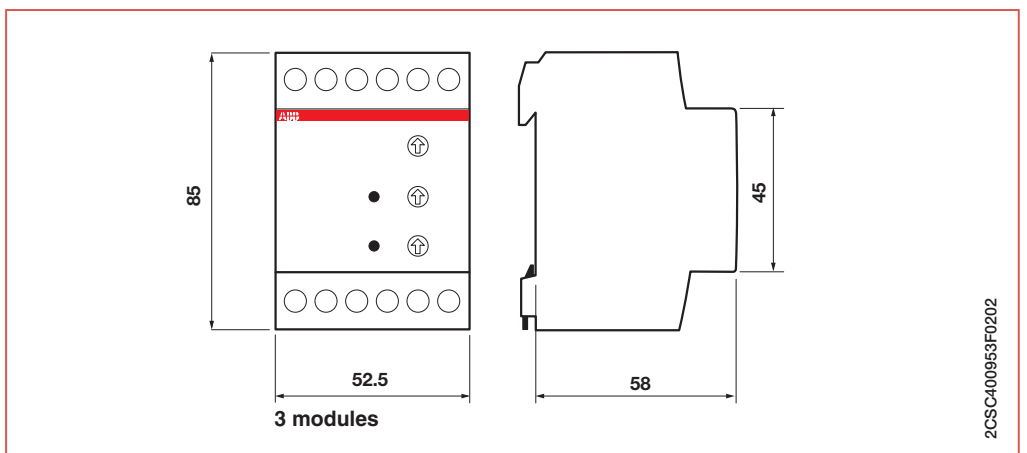

2CSC400953F0202



2CSC400462F0201

E 236 undervoltage monitoring relays

US1
US2

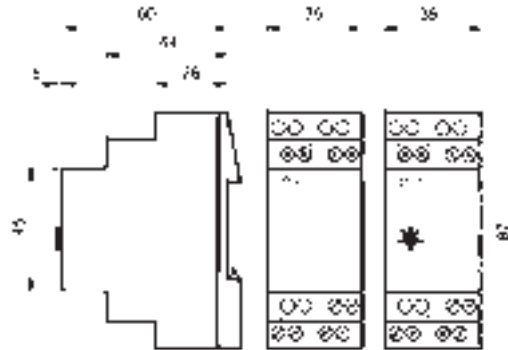

US1.1
US2.1
US1.1D

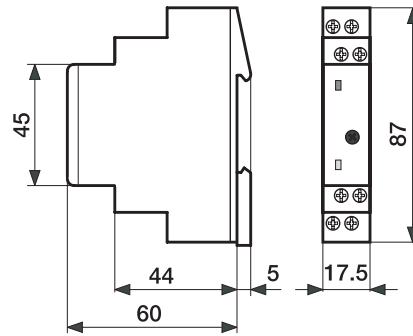

2CSC400375F0201



2CSC400265F0201

LEE 230 power failure signalling lamp

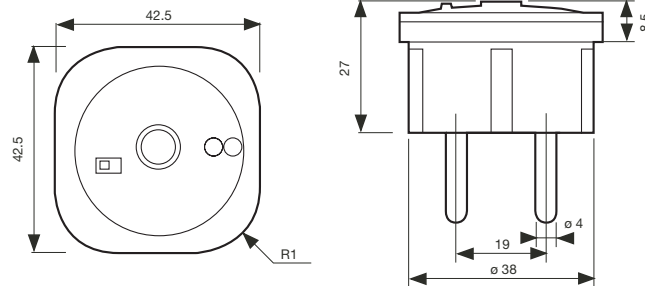

2CSC400954F0202



2CSC400517F0201

Analogue measurement instruments

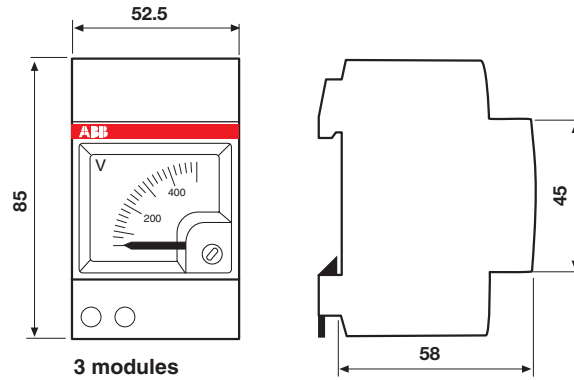

2CSC400555F0202



2CSC445064F0001

Front panel analogue measurement instruments

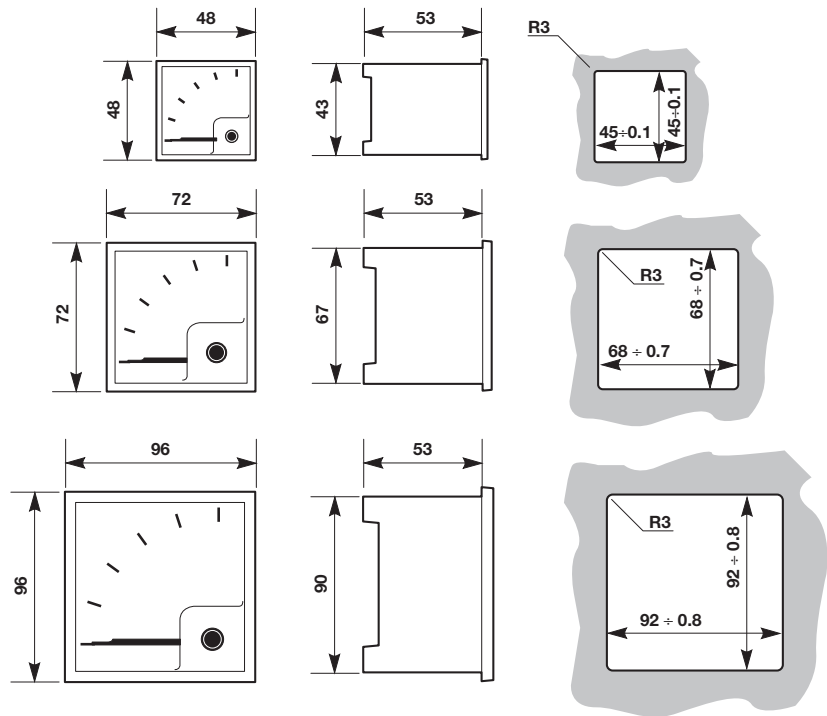

2CSC400956F0202



2CSC400958F0202

Digital measurement instruments

VLMD-1-2, AMTD-1, AMTD-2, VLMD-1-2-R, AMTD-1-R, AMTD-2-R

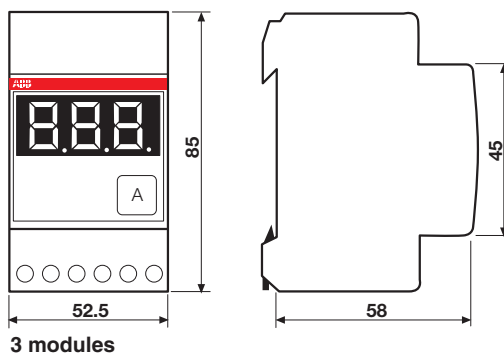

2CSC400957F0202



2CSC400959F0202

Front panel analogue measurement instruments

VLMD P, VLMD-R P, AMTD-1 P, AMTD-1-R P, AMTD-2 P, AMTD-2-R P

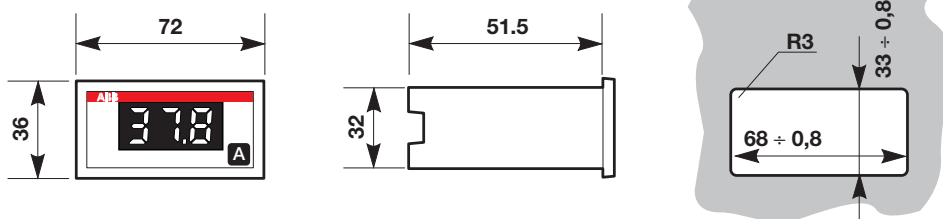

2CSC400960F0202



2CSC400520F0201

MCV - MCA voltmetric and ammetric switches

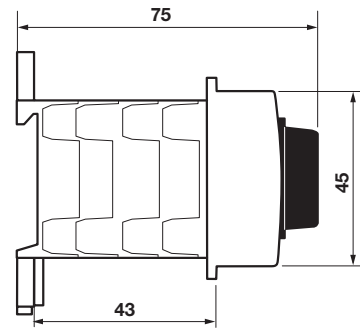
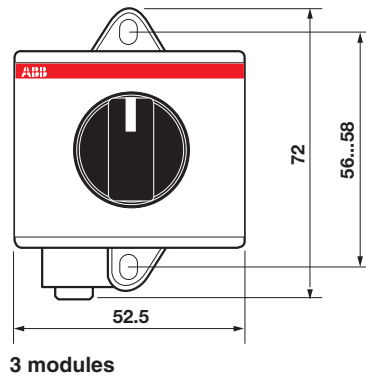

2CSC400962F0202



2CSC445148F0001

QCV - QCA front panel voltmetric and ammetric switches

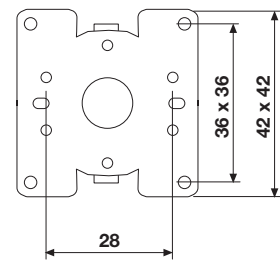
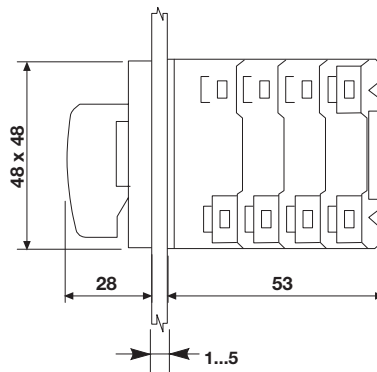

2CSC400963F0202



2CSC400961F0202

DMTME multimeters

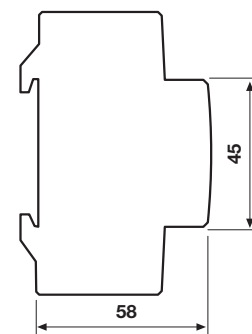
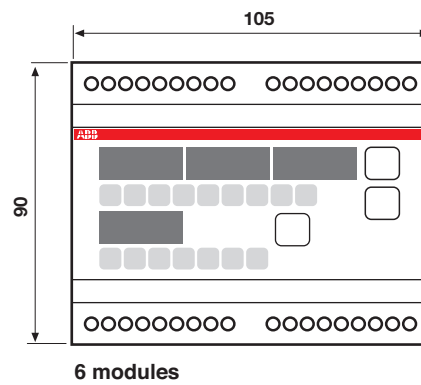

2CSC400964F0202



2CSC400966F0202

DMTME-96 and DMTME-72 front panel multimeters

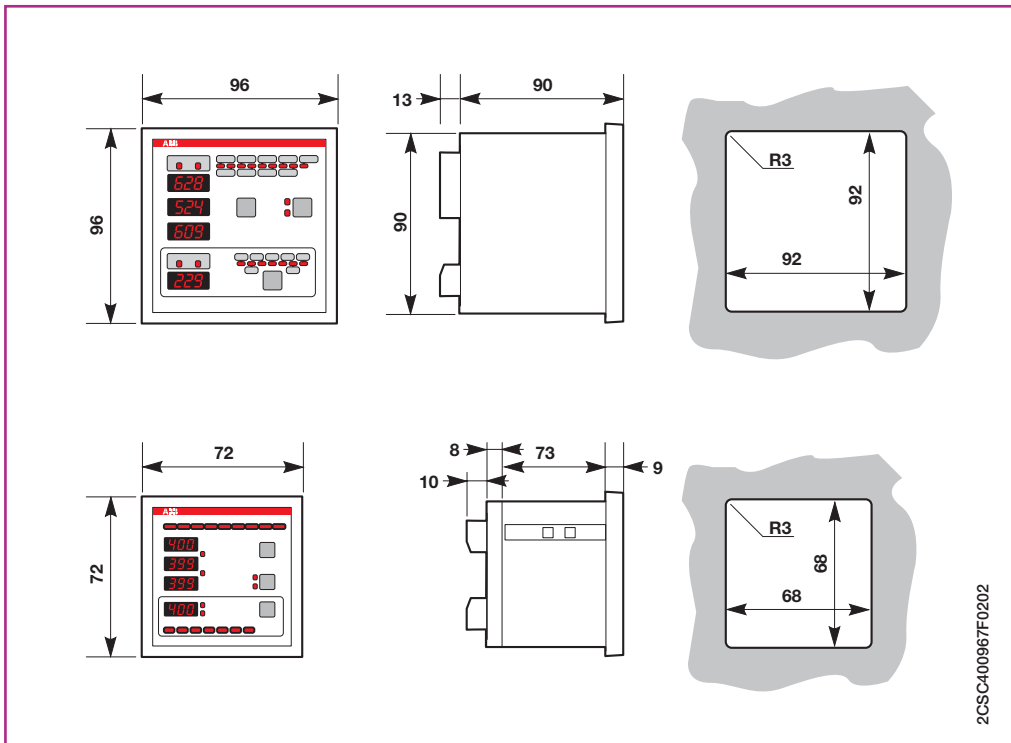

2CSC400967F0202



2CSC400966F0202

ANR network analysers

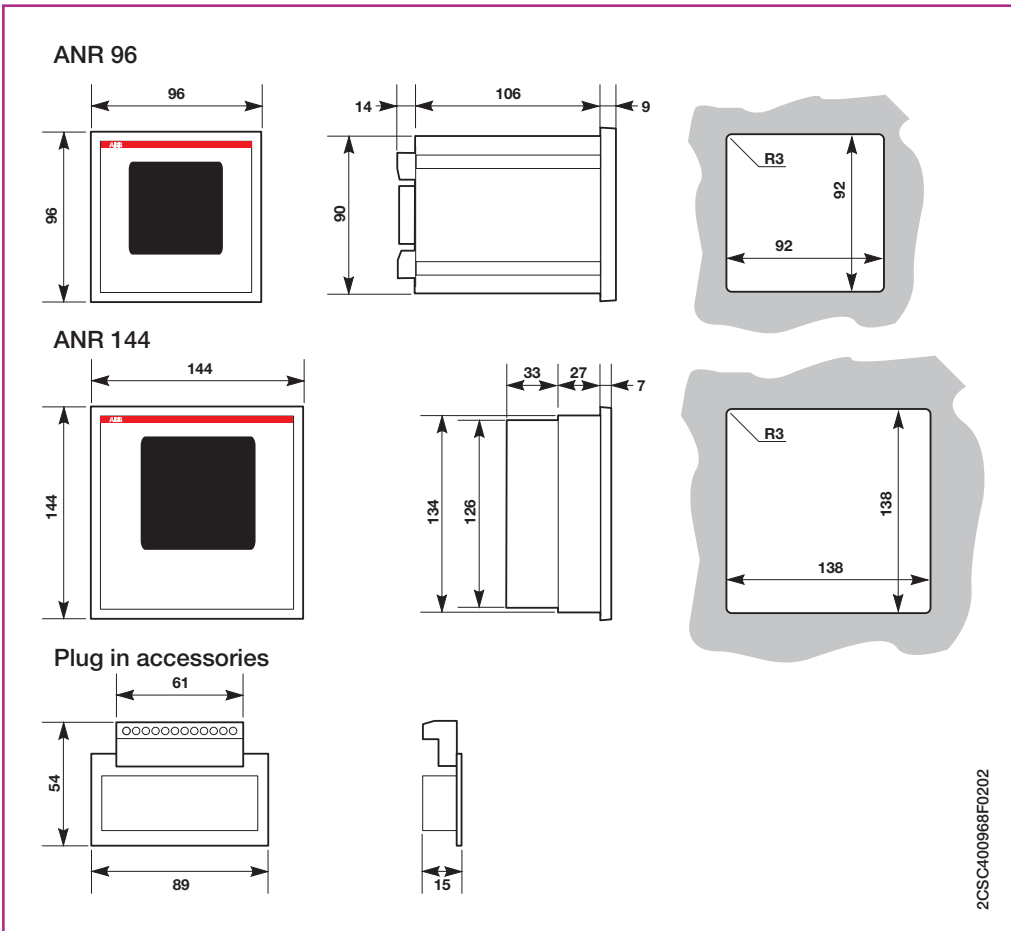

2CSC400988F0202



CUS serial converters

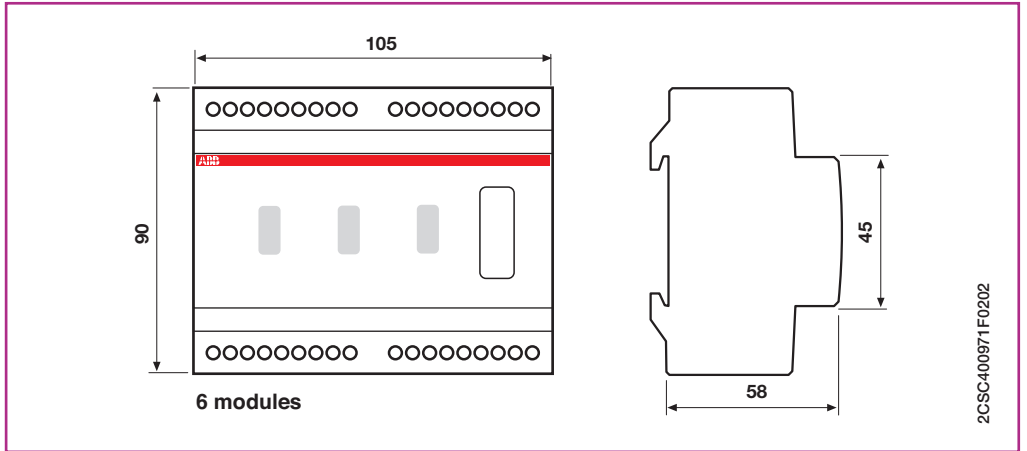

TMD temperature control units

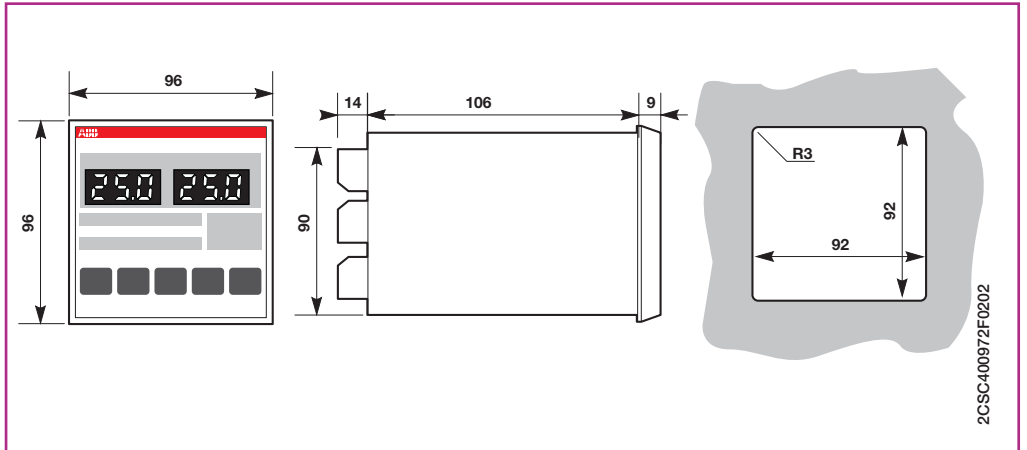

Modular current transformers with through primary

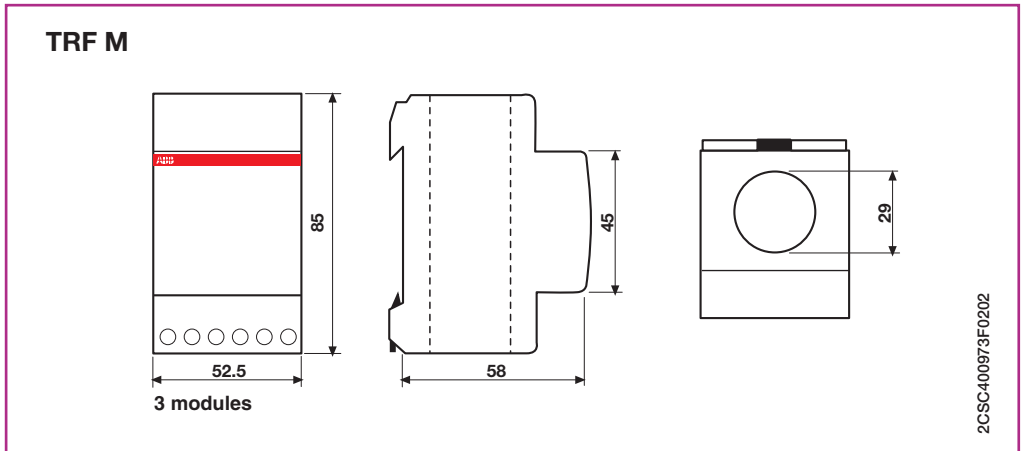

Standard type current transformers.../5 A with wound primary

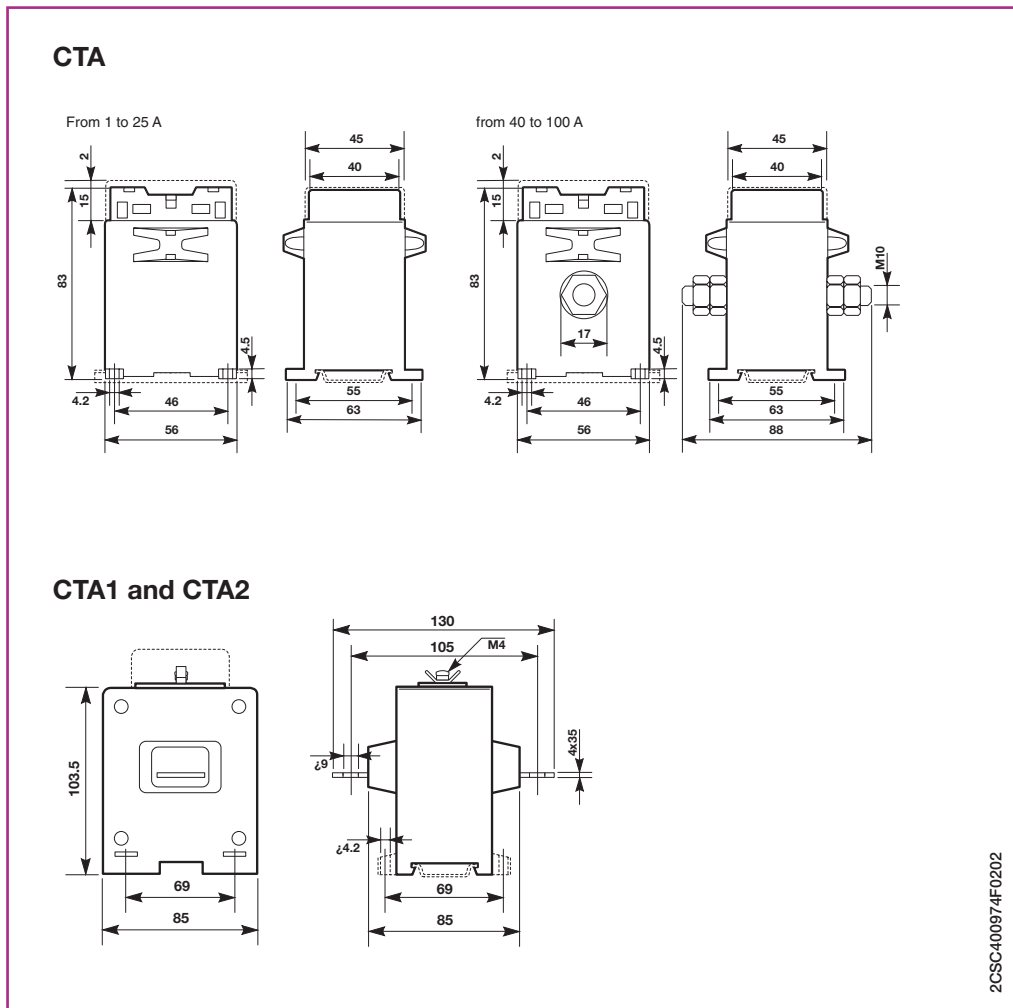

Standard type current transformers.../5 A with through primary

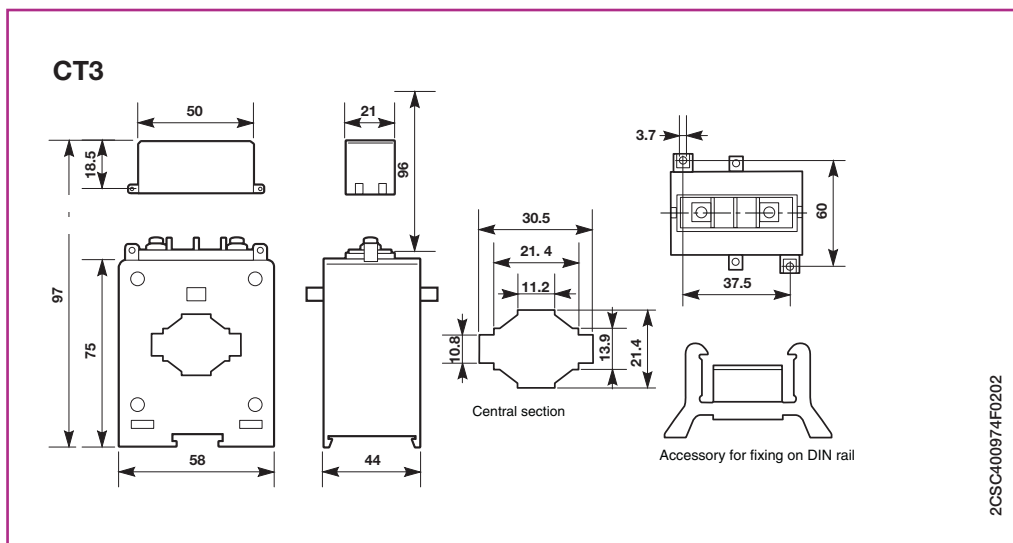

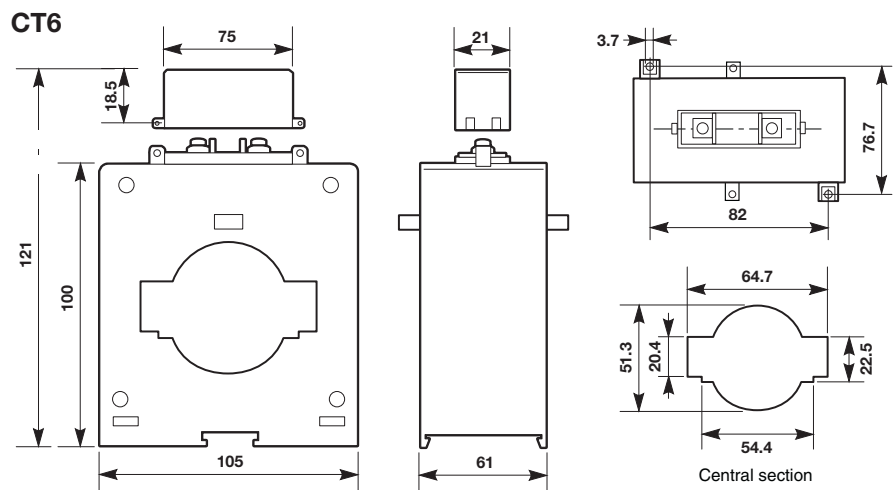
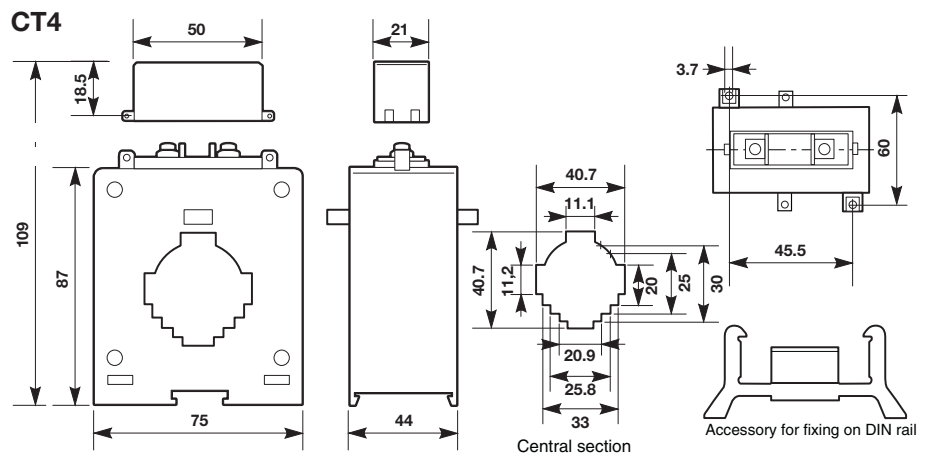

2CSC400975F0202

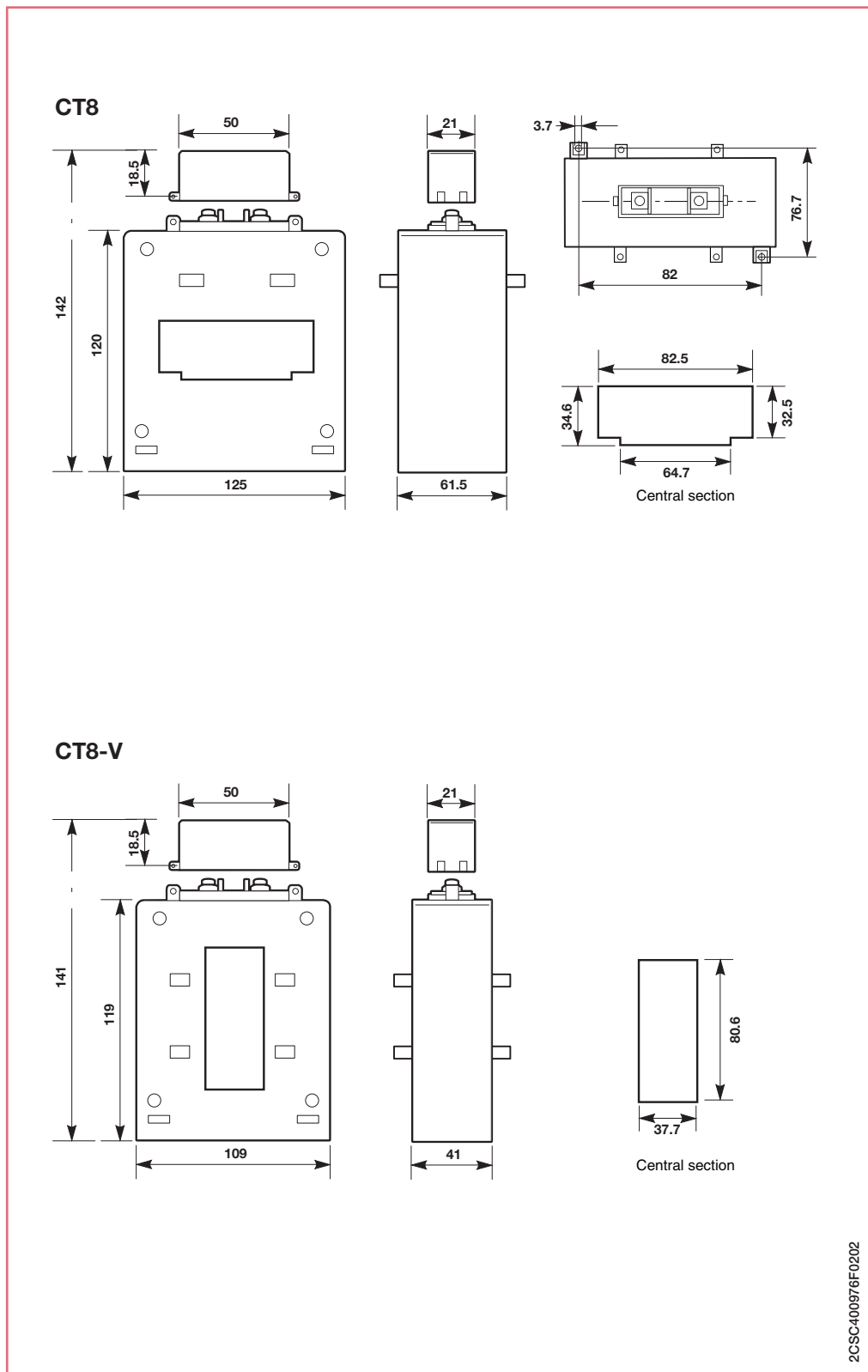

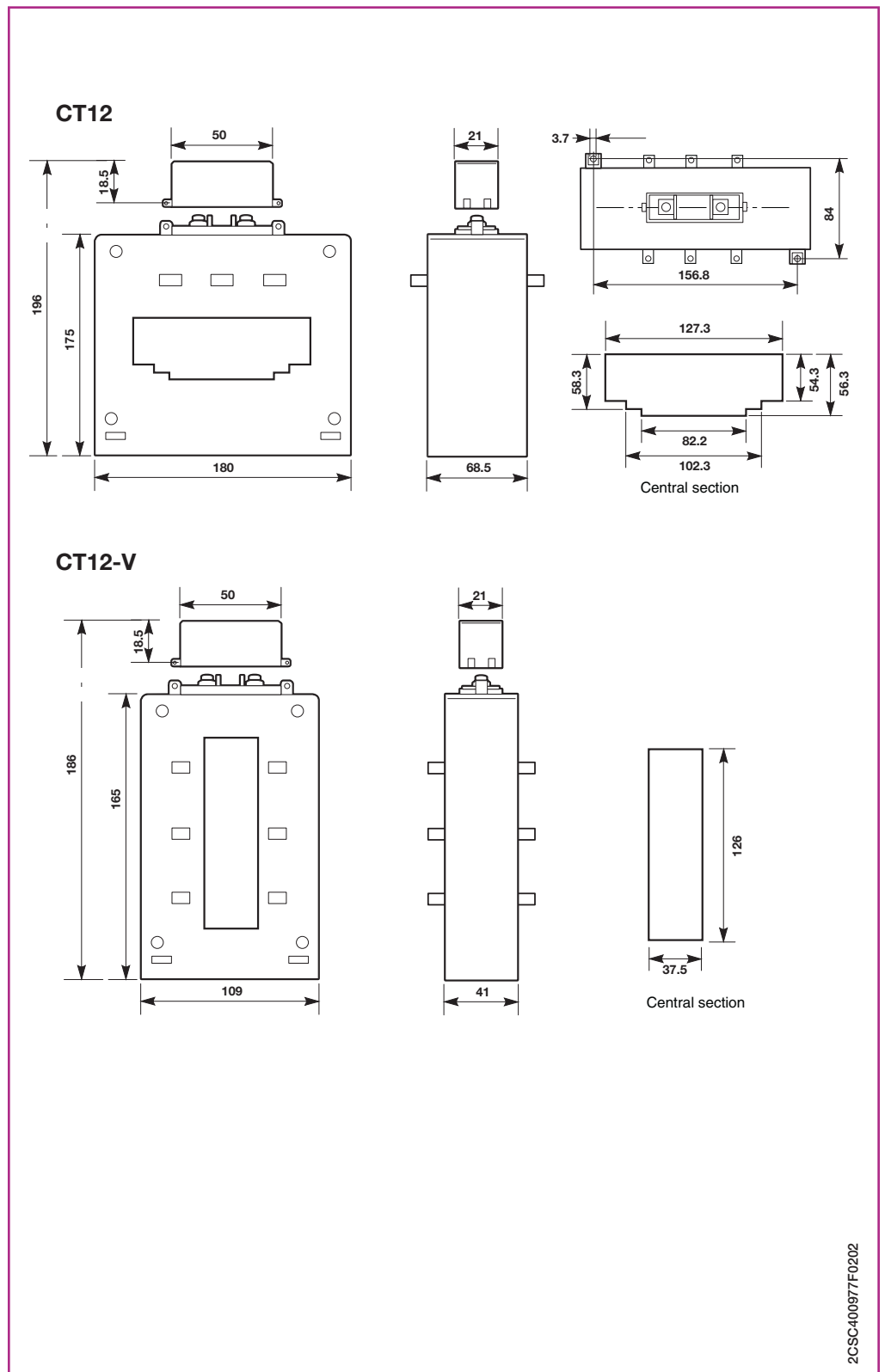

2CSC400977F0202



2CSC400141F0202

Split core current transformers.../5 A

CTO

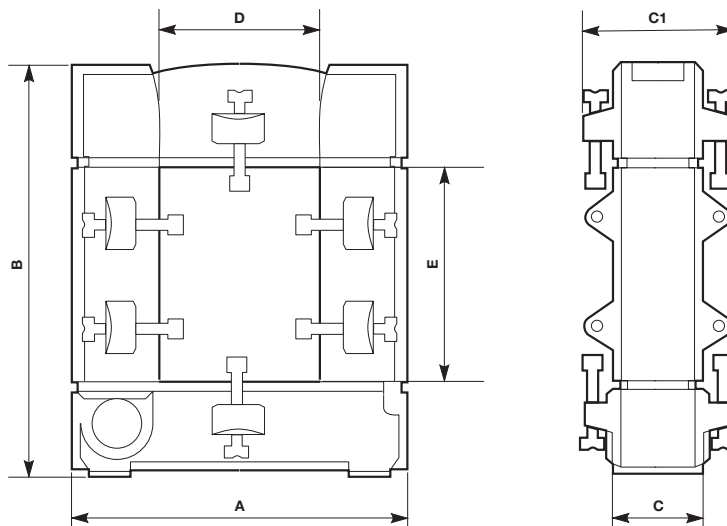

Tipo	A	B	C	C1	D	E
CT30...	93	106	34	58	20	30
CT80...	125	152	34	58	50	80
CT120...	155	198	34	58	80	120

2CSC400978F0202



2CSC400119F0201

Summing current transformers

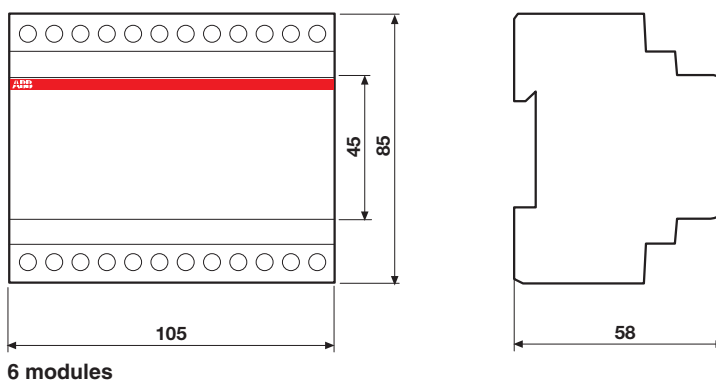

6 modules

2CSC400979F0202

Voltage transformers

TV

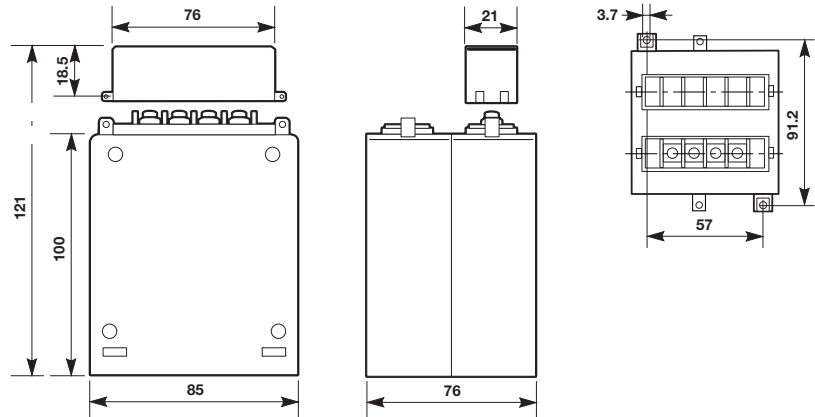

TV2

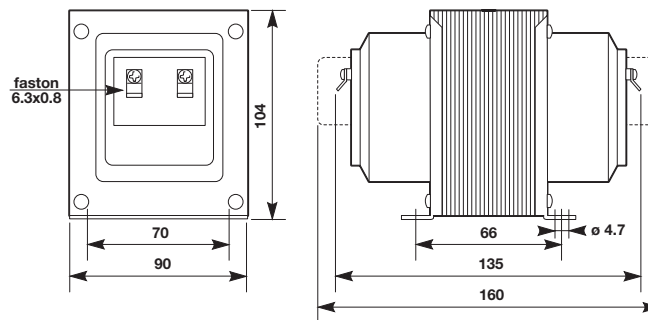

TV4

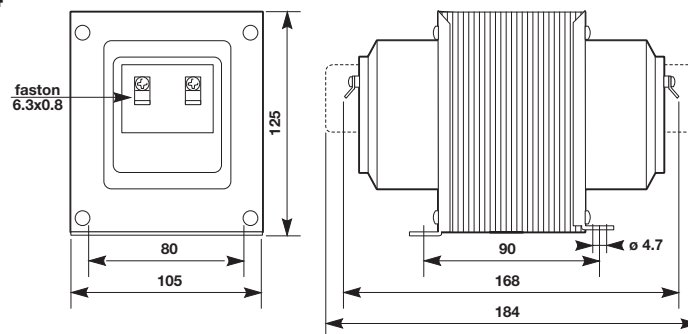

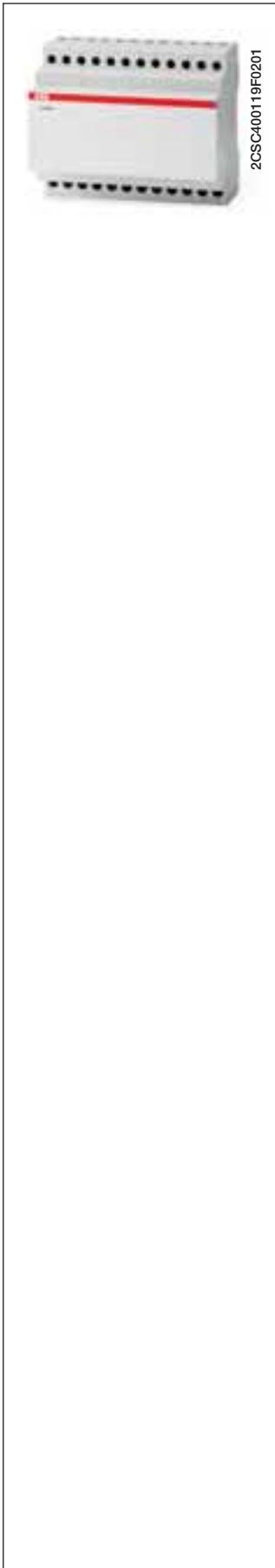

CONV and CNV

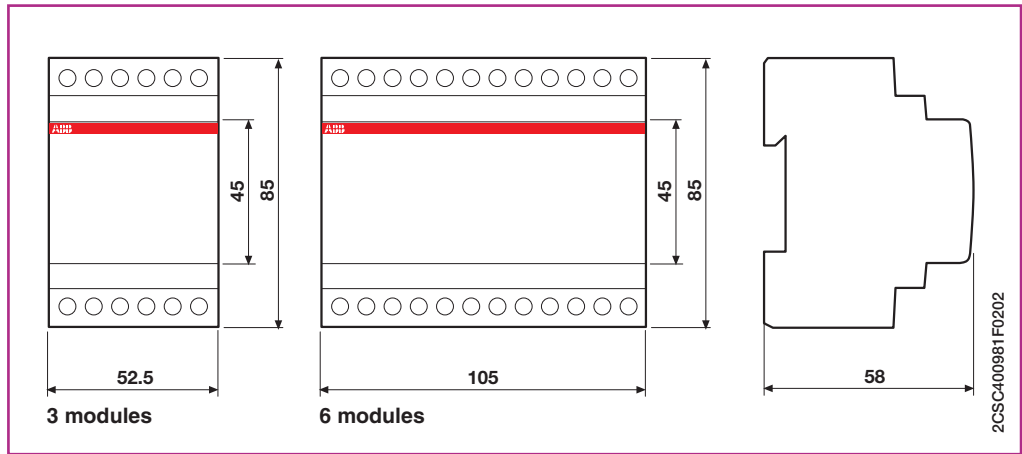



2CSC400523F0201

Shunts

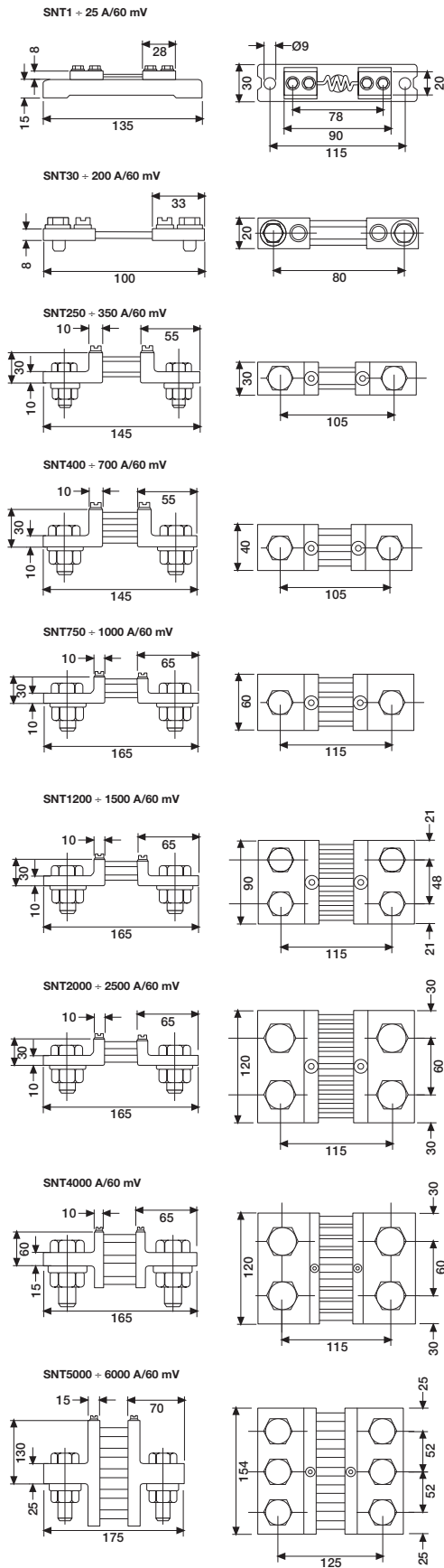

2CSC400982F0202



2CSC400459F0201

E 233 electro-mechanical hour counters

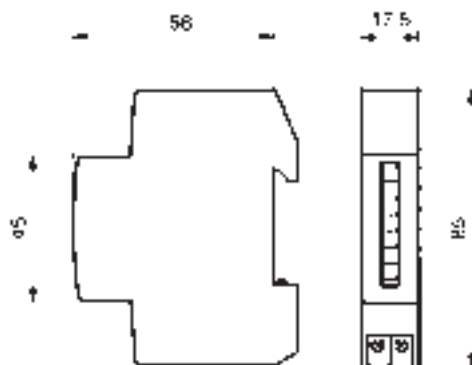

2CSC40085F0201



2CSC400524F0201

HMT electro-mechanical hour counters

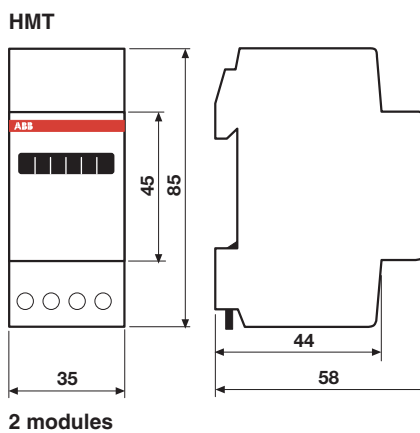

2CSC400883F0202

EMT electronic single phase energy meters



2CSC400749F0001



3 modules

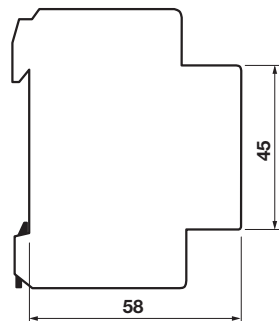

2CSC400885F0202

ODINsingle electronic single phase energy meters



2CSC400984F0202

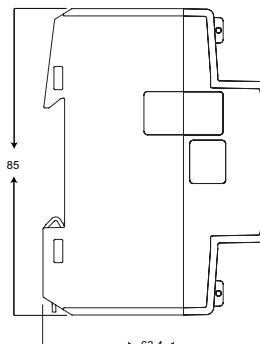
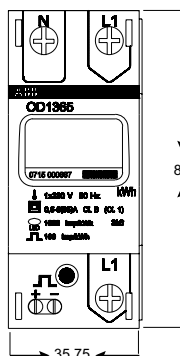

2CMC482008F0017

ODIN Meter electronic three-phase energy meters



2CSC400280F0201

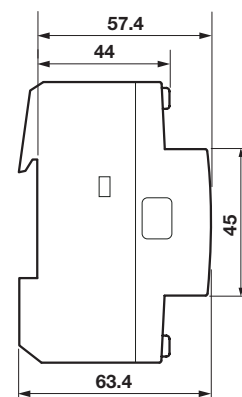
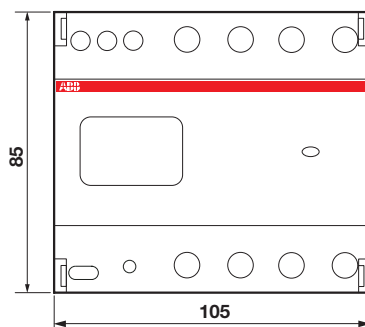

2CSC400986F0202



2CMC481009F0007

DELTAsingle electronic single phase energy meters

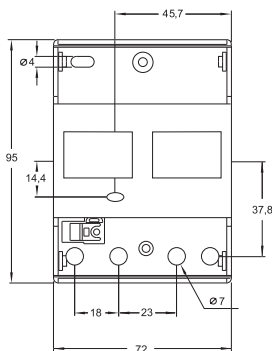

2CMC481029F0012



2CSC400549F0201

DELTAplus electronic three-phase energy meters

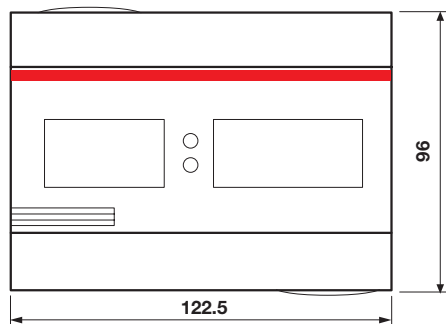

7 modules

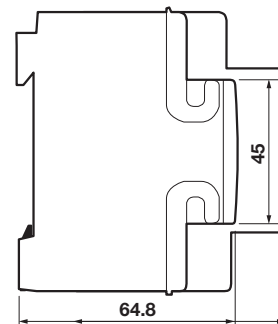

2CSC400987F0202



2CSC400988F0202

TS-C safety isolating transformers for general use

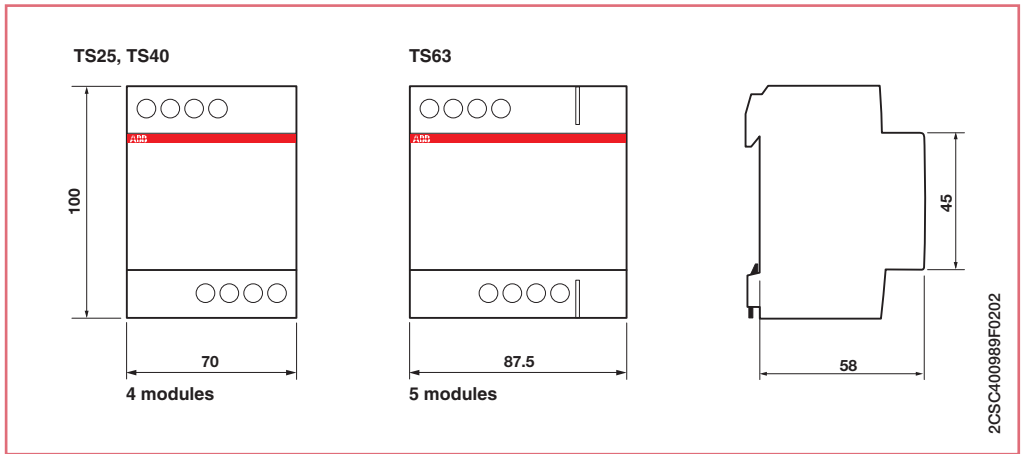

2CSC400989F0202



2CSC400595F0001

TM/TS bell transformers

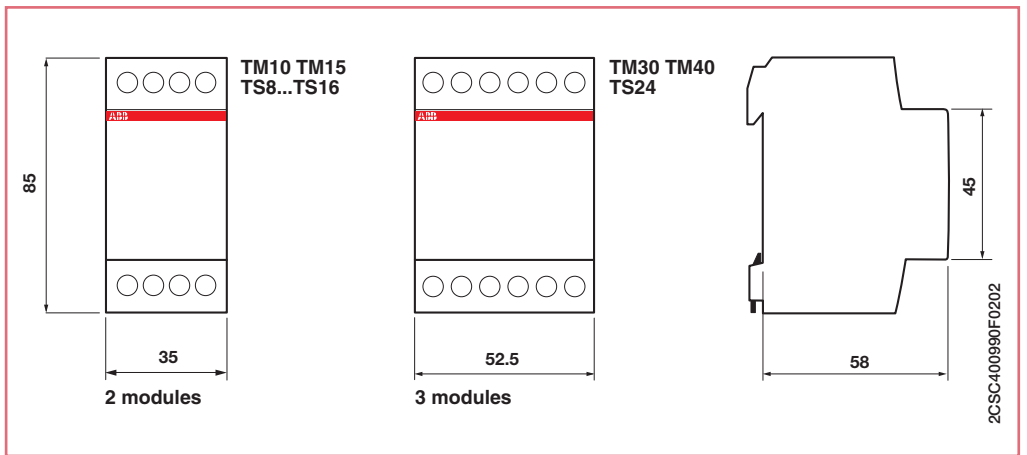

2CSC400990F0202



2CSC400800F0202

Bells and buzzers

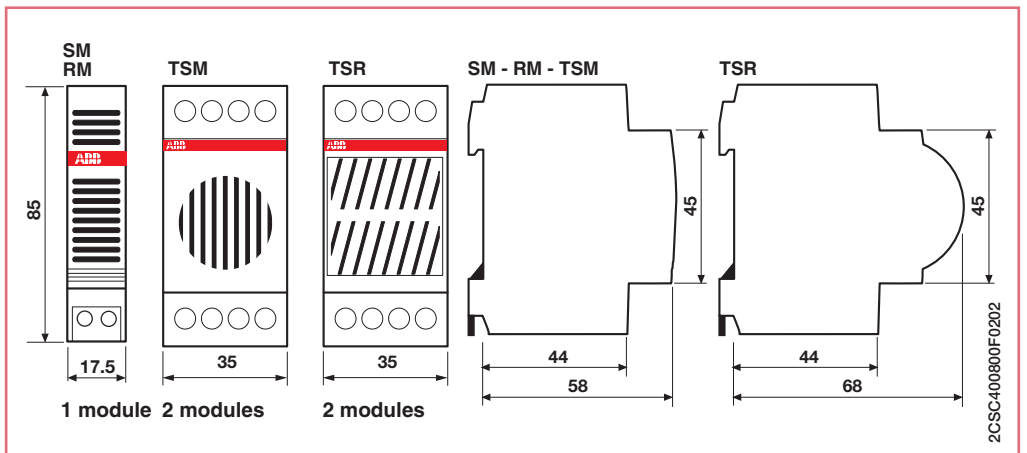

2CSC400800F0202



CDC271025F0b07

CP-D primary switch mode power supplies

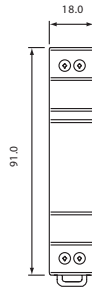

CP-D 12/0.83,
CP-D 24/0.42

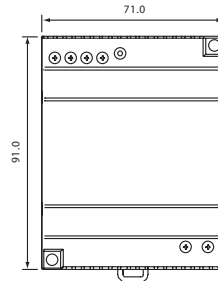

CP-D 24/2.5

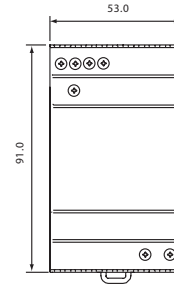

CP-D 12/2.1, CP-D 24/1.3

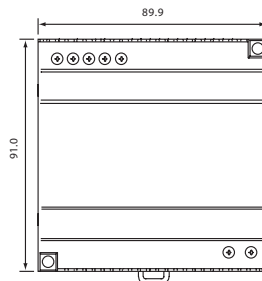

CP-D 24/4.2

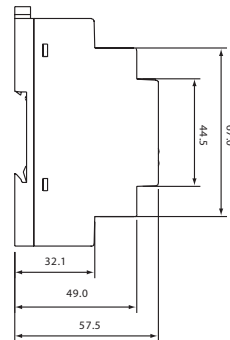

2CDC272011F0b07

TM control, isolating and safety transformers



from 50 up to 400 VA

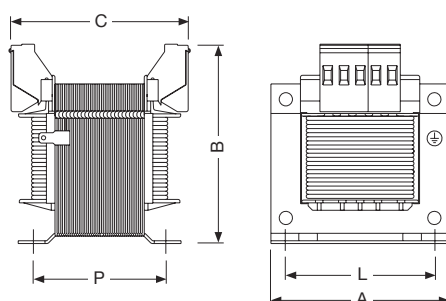

from 630 up to 2500 VA

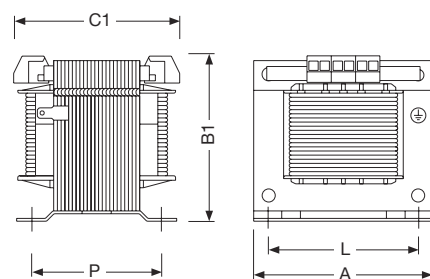

2CSC400992F0202

TM-C control transformers

Power (VA)	Picture	Dimensions							Screw	Wheight (Kg)
		A	B	B1	C	C1	P	L		
50	1	76	89	-	69	-	46	56	M4	1.1
100	1	85	95	-	87	-	63	64	M4	2
160	1	97	106	-	89	-	73	84	M5	3
200	1	97	106	-	89	-	73	84	M5	3.2
250	1	97	106	-	105	-	89	84	M5	3.6
320	1	121	122	-	91	-	73	90	M5	4.4
400	1	121	122	-	104	-	85	90	M5	5.5
630	2	151	-	150	-	122	90	122	M6	7.8
1000	2	151	-	150	-	166	133	122	M6	13.2
1600	2	193	-	184	-	163	125	155	M8	21.2
2000	2	193	-	184	-	181	143	155	M8	25.5
2500	2	193	-	184	-	191	153	155	M8	26.8

TM-S safety transformers and TM-I isolating transformers

50	1	76	89	-	69	-	46	56	M4	1.1
100	1	85	95	-	87	-	63	64	M4	2
160	1	97	106	-	89	-	73	84	M5	3
200	1	97	106	-	89	-	73	84	M5	3.2
250	1	97	106	-	105	-	89	84	M5	3.6
320	1	121	122	-	91	-	73	90	M5	4.4
400	1	121	122	-	104	-	85	90	M5	5.5
630	2	151	-	150	-	122	90	122	M6	7.8
1000	2	151	-	150	-	166	133	122	M6	13.2
1600	2	193	-	184	-	163	125	155	M8	21.2
2000	2	193	-	184	-	181	143	155	M8	25.5
2500	2	193	-	184	-	191	153	155	M8	26.8



2CSC400536F0201

Modular sockets

M1170
M1173
M1174
M1175
M1176

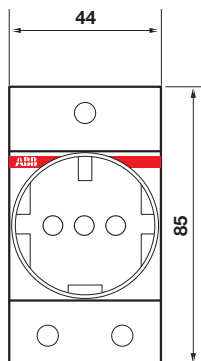

2.5 modules

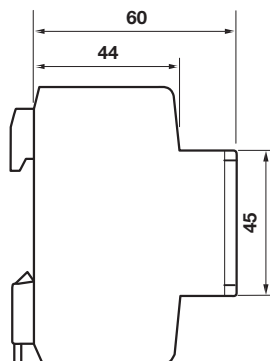

M1363

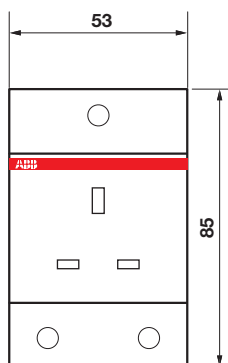

3 modules

2CSC400993F0202



1SFC151347F0001

MA1-8001 DIN rail adapter

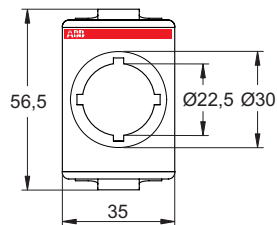

2 modules

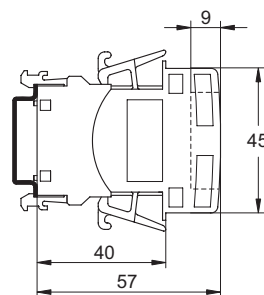

2CSC400994F0202



Index

Worldwide marks and approvals	14/2
-------------------------------------	------

System pro M compact® MCBs and RCDs

Worldwide marks and approvals

This is the present situation regarding worldwide marks and approvals for ABB System pro M compact range devices. Although some products already obtained some approvals or certificates, they don't necessarily bear the related marks on the product.



AENOR - Spain



BBJ - Poland



BSMI - Taiwan



CCC - China



S 200	■ S 200	■ S 200	● S 200
S 200 M	■ S 200 M	■ S 200 M	● S 200 M
S 200 P	■ S 200 P	■ S 200 P	● S 200 P
S 200 U			● S 200 U
S 200 UP			● S 200 UP
SN 201			■ SN 201
S 280			■ S 280
S 290			■ S 290
S 800			■ S 800
S 500-K, S 500UC-K			■ S 500-K, S 500UC-K
F 200	■ F 200	■ F 200 ③	■ F 200 ③
DDA 200			
DS 200			
DS201			■ DS201
DS202C			
DS 271			
DDA for S 290			
DDA 800			
F2C..			
S 290 accessories			



GOST - Ucraina



IMQ - Italy



IRAM - Argentina



KEMA - Netherland



S 200		■ S 200	■ S 200
S 200 M		■ S 200 M	■ S 200 M
S 200 P		■ S 200 P	■ S 200 P
S 200 U			
S 200 UP			
SN 201		■ SN 201	■ SN 201
S 280		■ S 280	
S 290			
S 800			
F 200	■ F 200	■ F 200	■ F 200 ③
DDA 200	■ DDA 200	■ DDA 200	
DS 200	■ DS 200	■ DS 200	
DS201	■ DS201	■ DS201	■ DS201
DS202C	■ DS202C	■ DS202C	
DS 271	■ DS 271		
DDA for S 290	■ DDA for S 290		
DDA 800	■ DDA 800		

Legend:

■ Approved

● Waiting for approval

① Supplementary protection

② Branch circuit protection

③ Available for F200 type for overseas markets

④ Only S 500-K range

Indicated approvals are the whole of the approvals for all devices versions; contact your LSO to know which are the approvals obtained for each device version



SIQ - Slovenia



SIRIM - Malaysia



RCM - Australia



UL - USA



S 200	■ S 200	■ S 200	■ S 200	■ S 200 ①
S 200 M	■ S 200 M	■ S 200 M	■ S 200 M	
S 200 P	■ S 200 P		■ S 200 P	■ S 200 P ①
S 200 U				■ S 200 U ②
S 200 UP				■ S 200 UP ②
SN 201			■ SN 201	
S 280			■ S 280	
S 290				■ S 290
S 800				■ S 800
S 500-K, S 500UC-K				■ S 500-K, S 500UC-K
F 200		■ F 200 ③	■ F 200 ③	■ F 200
F 204 B				
DDA 200				
DS 200				
DS201			■ DS201	
DS202C			■ DS202C	
DS 271			■ DS 271	
DDA for S 290				
DDA 800				

The F 200 range has obtained the EPD (Environmental Product Declaration), according to ISO 14040.



System **Worldwide marks and approvals**

pro M compact® MCBs and RCDs



CEBEC - Belgium



- S 200
- S 200 M
- S 200 P



CERTIF - Portugal



- S 200
- S 200 M
- S 200 P



CSA - Canada



- S 200 ①
- S 200 P (≤ 25 A) ①
- S 200 U ②
- S 200 UP ②



DEMKO - Denmark



- S 200
- S 200 M
- S 200 P



EZU - Czech Rep.



- S 200
- S 200 M
- S 200 P



FIMKO - Finland



- S 200
- S 200 M
- S 200 P



GOST - Russia



- S 200
- S 200 M
- S 200 P

- S 280
- S 290
- S 800

- F 200

- F 200

- F 200

- F 200

- F 200

- DS201

- DDA 200
- DS 200
- DS201
- DS202C

- F2C..

- S 290 accessories



LCIE - France



- S 200
- S 200 M
- S 200 P



NEMKO - Norway



- S 200
- S 200 M
- S 200 P



OVE - Austria



- S 200
- S 200 M
- S 200 P



PSB - Singapore



- S 200



SABS - South Africa



- S 200



SEMKO - Sweden



- S 200
- S 200 M
- S 200 P



SEV - Switzerland



- S 200
- S 200 M
- S 200 P

- S 280

- F 200
- DDA 200
- DS 200

- F 200

- F 200

- F 200 ③

- F 200 ③

- F 200

- S 800
- F 200

- DS202C

- DS201

- DS201



VDE - Germany



- S 200
- S 200 M
- S 200 P



DNV - Norway



- S 200
- S 200 M
- S 200 P



GL - Germany



- S 200
- S 200 M



LRS - Great Britain



- S 200
- S 200 M
- S 200 P



RINA - Italy



- S 200
- S 200 M
- S 200 P



RMRS - Russia



- S 200
- S 200 M
- S 200 P

- S 290

- S 280

- S 280

- S 280

- S 800
- S 500-K ④

- S 800

- S 800

- S 800

- S 800

- S 500-K ④

- F 200
- F 204 B

- DS 200
- DS201
- DS202C

- DS202C

System **Worldwide marks and approvals**

pro M compact® Modular devices



OVR		■ OVR T1 and T2	
RD		■ RD	■ RD
TR-TRM		■ TR-TRM	■ TR-TRM
E 90	■ E 90	■ E 90	■ E 90
E 930			
E 200	■ E 200		■ E 200
E210	■ E210 ③	■ E210	
ESB	■ ESB		
EN	■ EN		
E 259		■ E 259	■ E 259
E 250		■ E 250	■ E 250
E 260		■ E 260	■ E 260
E 234	■ E 234	■ E 234	
AT		■ AT	■ AT
D Line		● D	
E 232		■ E 232	
TW		■ TW	■ TW
THS		■ THS	
RAL		■ RAL	■ RAL
LSS1/2		■ LSS1/2	■ LSS1/2
RH/RL		■ RH/RL	■ RH/RL
SQZ3		■ SQZ3	■ SQZ3
LEE 230		■ LEE 230	■ LEE 230
CT / CTA / TRFM		■ CT/CTA/TRFM	■ CT/CTA/TRFM
MCA/MCV		■ MCA/MCV	
HMT		■ HMT	
TM		■ TM	■ TM ②
TS		■ TS	■ TS
TS-C		■ TS-C	■ TS-C
TSM/TSR		■ TSM/TSR	■ TSM/TSR
SM/RM		■ SM/RM	■ SM/RM
M1170		■ M1170	
M1173		■ M1173	■ M1173
M1174	■ M1174	■ M1174	■ M1174
M1175		■ M1175	■ M1175
M1176			
M2071			
TM-C, TM-I, TM-S	■ TM-C, TM-I, TM-S	■ TM-C, TM-I, TM-S	■ TM-C, TM-I, TM-S

Legend:

■ Approved whole range

● Waiting for approval

① Except for ESB/EN 20

② Except for TM40

③ For series E219 CCC mark not needed

System **Worldwide marks and approvals** **pro M compact[®]** Modular devices



UL/CSA
USA/Canada



VDE
Germany



BV/F
France



GL/D
Germany



LRS
Great Britain



RINA
Italy



RMRS
Russia



RCM
Australia



IRAM
Argentina



● OVR T1 and T2 ■ OVR T2 40 275

■ E 90

■ E 930

■ E 200

■ E210

■ E210

■ ESB

■ EN

■ E 90

● E 90

● E 90

■ ESB ①

■ EN ①

■ ESB ①

■ EN ①

■ E 260

■ E 234

■ E 232

■ TS

■ TS-C

■ M1175

■ TM-C, TM-I, TM-S

● M1176

● M2071

Type	Description	Chapter	Page
A			
AMT	Modular analogue ammeters	8	8/12
AMT	Front panel analogue ammeters	8	8/15
AMTD	Modular digital ammeters	8	8/26
AMTD P	Front panel digital ammeters	8	8/27
ANR	Network analysers	8	8/6
AT	Electro-mechanical time switches	6	6/47
ATT	GSM modules	6	6/74
B			
BS9..., BF2...	Busbars for SN201 MCBs	4	4/33
C			
CL	Logic relays	6	6/76
CNV	Transducers for angle phase meters	8	8/55
CONV	Current and voltage converters	8	8/54
COP	Caps and terminal covers	8	8/25
CP-D	Primary switch mode power supplies	9	9/11
CSF	Modular analogue power factor meter	8	8/12
CSF	Front panel analogue power factor meter	8	8/15
CT	Current transformer with through primary	8	8/47
CTA	Current transformer with wound primary	8	8/45
CTO	Split core current transformer with thorough primary	8	8/50
CTSM	Summing current transformers	8	8/52
CUS	Serial converter	8	8/9

Type	Description	Chapter	Page
D			
D Line and DTS	Digital time switches	6	6/51
DDA 200	RCD-Blocks for S200 MCBs	3	3/22
DDA 60, DDA 70, DDA 90	RCD-Blocks for S290 MCBs	3	3/64
DDA 800	RCD-Blocks for S800 MCBs	3	3/68
DELTAplus/ DELTAmix	Three-phase energy meters	8	8/36
DELTAsingle	Single phase energy meters	8	8/33
	Accessories for electronic energy meters	8	8/44
DMTME	Modular multimeters	8	8/3
DMTME-96 and DMTME-72	Front panel multimeters	8	8/3
DS 200	RCBOs	3	3/50
DS 271	1P+N Electronic RCBOs	3	3/82
DS 800	RCBOs	3	3/74
DS201	1P+N RCBOs	3	3/32
DS202C	2P RCBOs	3	3/44
DS2C-CM	Motor operating device for DS201-DS202C RCBOs	4	4/16
E			
E 200	Switches	6	6/2
E 210	Switches, pushbuttons and indicator lamps	6	6/6
E 232	Staircase lighting time-delay switches	6	6/62
E 234 CT-D	Electronic timers	6	6/39
E 235	Mains disconnection relays	7	7/8
E 236	Undervoltage monitoring relays	7	7/12
E 250	Latching relays	6	6/24
E 259	Installation relays	6	6/22
E 260	Latching relays	6	6/29
E 450	Priority switches	7	7/2
E 463/3, E 480/3	Switches	6	6/5
E 90	Fuse switch disconnectors, fuse holders and fuse disconnectors	5	5/12
E 930	Fuse disconnectors	5	5/19
E 9F	Cylindrical fuses	5	5/22
E233	Electro-mechanical hour counters	8	8/40
EN	Contactors	6	6/17
EPD24	Electronic protection devices	5	5/36
ESB	Contactors	6	6/15

Type	Description	Chapter	Page
F			
F 200	RCCBs	3	3/6
F2 125A-S/H	Signal/ auxiliary contact for F 200 125A and F 200 B	4	4/13
F2C-A...	Shunt trips for F 200 RCCBs and DS201/ DS202C RCBOs	4	4/13
F2C-ARH	Home automatic resetting unit for F 200 RCCBs	4	4/16
F2C-ARI	Auto-reclosing units for F 200 RCCBs	4	4/16
F2C-CM	Motor operating devices for F 200 RCCBs	4	4/16
FEED-IN	Terminals for SN201 busbars	4	4/33
FLR	Latching relays	6	6/31
FRZ	Modular analogue frequency meter	8	8/12
FRZ	Front panel analogue frequency meter	8	8/15
FRZ-DIG	Modular digital frequency meter	8	8/26
H			
HMT	Electro-mechanical hour counters	8	8/41
I			
ILTS	Switch-disconnectors	5	5/33
ISL	Industrial insulation monitoring devices	5	5/46
ISOLTESTER-DIG	Insulation monitoring devices	5	5/40
ISS	D0 fuse carriers	5	5/34
L			
LEE 230	Extractable power failure signalling lamp	7	7/15
LSS1/2	Load shedding switch	7	7/6
M			
M1170, M1173, M1174, M1175, M1176, M1363, M2071	Modular sockets	9	9/12
MA1-8001	DIN rail adapter	9	9/17
MCV-MCA	Modular voltmetric and ammetric switches	8	8/30
MeMo2 MeMo4	Modular DIN rail device with USB cable	4	4/22
O			
ODIN Meter	Three-phase energy meters	8	8/35
ODINsingle	Single phase energy meters	8	8/32
	Accessories for electronic energy meters	8	8/39
OVR	Surge Protective Devices	5	5/7
P			
PS...	Busbars	4	4/13, 4/18

Type	Description	Chapter	Page
Q			
QCV-QCA	Front panel voltmetric and ammetric switches	8	8/31
QSD-DIG 230/24	Remote signalling panel for insulation monitoring devices	5	5/42
QSO	Switchboards for medical locations	5	5/45
R			
RAL	Overload relays	7	7/4
RD	Front panel residual current relays	3	3/86
RD2	Residual current monitors	3	3/84
RD3	Residual current monitors	3	3/85
RH/RL	Maximum and minimum current/ voltage relays	7	7/10

Type	Description	Chapter	Page
S			
S 200	MCBs	2	2/8
	Accessories for S 200 MCBs	4	4/30, 4/34
S 280	MCBs	2	2/57
	Auxiliary elements for S 280 MCBs	4	4/42
S 290	MCBs	2	2/66
	Auxiliary elements for S 290 MCBs	4	4/46
S 500	MCBs	2	2/114
S 700	MCBs	2	2/71
	Auxiliary elements and accessories for S 700 MCBs	4	4/48
S 800	MCBs	2	2/77
	Auxiliary elements and accessories for S 800 MCBs	4	4/52
S2C-A...	Shunt trips for S 200 MCBs and DS 200 RCBOs	4	4/13
S2C-BP	Mechanical tripping device	4	4/14
S2C-CM	Motor operating devices for S 200 MCBs	4	4/16
S2C-EST	Plug-in base	4	4/15
S2C-Nt	Hand operated neutral	4	4/14
S2C-OVP...	Overvoltage releases for S 200 MCBs, F 200 RCCBs and DS201/DS202C RCBOs.	4	4/14
S2C-S.../S2C-H...	Signal/ auxiliary contacts for S 200 MCBs, F 200 RCCBs and DS 200 RCBOs	4	4/12
S2C-UA...	Undervoltage releases for S 200 MCBs, F 200 RCCBs, DS201/DS202C/ DS 200 RCBOs	4	4/14
SCL	Interchangeable scales for modular analogue instruments	8	8/18
SCL	Interchangeable scales for front panel analogue instruments	8	8/25
SELVTESTER	Insulation monitoring device for insulated networks at 24 V AC/ DC	5	5/42
SL	Luminous indicators for panel installation	6	6/13
SM, RM, TSM and TSR	Bells and buzzers	9	9/10
SN201	1P+N MCBs	2	2/50
SN201-S/ SN201-IH	Signal/ auxiliary contacts for SN201 MCBs	4	4/12
SNT	Shunts	8	8/56
SQZ3	Phase and sequence relay	7	7/9
STD	Dimmers	6	6/35

Type	Description	Chapter	Page
T			
THS	Modular thermostats	6	6/71
TI	Insulating transformers for medical locations	5	5/44
TM	Fail safe bell transformers	9	9/5
TM-C, TM-S, TM-I	Control, isolating and safety transformers	9	9/8
TMD	Temperature control units	8	8/42
TR	Toroidal transformers	3	3/87
TRFM	Modular current transformer	8	8/43
TS	Non-inherently short-circuit proof bell transformers	9	9/6
TS-C	Safety isolating transformers for general use	9	9/4
TV	Voltage transformers	8	8/53
TW	Twilight switches	6	6/65
V			
VLM	Modular analogue voltmeters	8	8/12
VLM	Front panel analogue voltmeters	8	8/15
VLMD	Modular digital voltmeters	8	8/26
VLMD P	Front panel digital voltmeters	8	8/27
W			
WT63	Selective Short-Circuit Current Limiter	2	2/76

Contact us

ABB SACE a division of ABB S.p.A.
ABB STOTZ-KONTAKT GmbH

In consideration of modifications to Standards and materials, the characteristics and overall dimensions indicated in this catalogue may be considered binding only following confirmation by ABB

Copyright 2011 ABB. All rights reserved.