

Floor ducts & finishing accessories

Number(s) : 0 328 00/01/02/03/05/06/07/10, 0 300 88/90/91/92/93, 030011/12/18/19, 0 317 48/49, 010771/72/74, 010690



CONTENTS	PAGES
1. Range	1 to 3
2. Components	3 to 5
3. Implementation	5
4. Technical characteristics	6
5. Material characteristics	6

1. RANGE

The floor duct distribution system provides:

- distribution, protection and branching of different cables in an electrical installation
- profiles, finishing and routing accessories (end cap, flat angle, junction box, cover joint)
- optimum reliability and safety through compliance with standard NF EN 50085-2-2

For creating a link between a profile, column, mini-column or floor unit.

1.1. Floor duct 50x12 mm Cat. No. 0 300 92

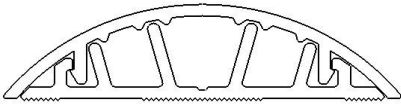

Supplied in lengths of 2 m, packs of 54 m
To be cut with saw (metal type saw) and cutting box (Cat. No. 0 306 98)
Body and cover made solid by snap-fitting (removable using tool, e.g. screwdriver, etc.)
3 compartments
Colour, grey RAL 7030

1. RANGE (continued)

1.1. Floor duct 50x12 mm Cat. No. 0 300 92 (continued)

Overall dimensions:

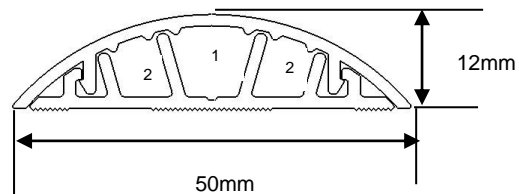

Cabling capacity:

50 x 12 mm	1	2
Section utile en mm ² par compartiment	70	40
∅ 6 mm	1	1
∅ 8 mm	1	-
Câble ∅ Maxi en mm	8	6

1. RANGE (continued)

1.2. Floor duct 75x18 mm, Cat. No. 0 300 88/90/91/93

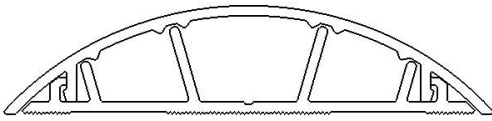

Supplied in lengths of 2m, packs of 36m
 To be cut with saw (metal type saw) and cutting box
 (Cat. No. 0 306 98)
 Body and cover made solid by snap-fitting (removable using tool,
 e.g. screwdriver, etc.)
 3 compartments
 2 finitions :
 - PVC
 . colour grey RAL 7030 ref. 0 300 93
 . colour white RAL 9003 ref. 0 300 88
 . colour black RAL 9017 ref. 0 300 90
 - Aluminium (body in PVC - cover in aluminium)
 ref. 0 300 91

Overall dimensions:

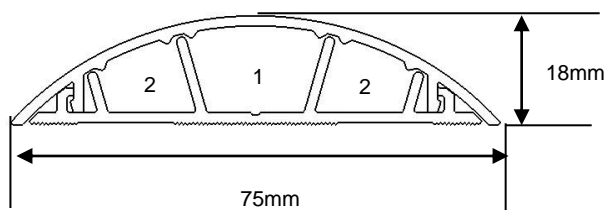

Cabling capacity:

75 x 18 mm	1	2
Section utile en mm ² par compartiment	210	120
∅ 7 mm	5	1
∅ 9 mm	2	1
∅ 11 mm	1	1
Câble ∅ Maxi en mm	14	11

1. RANGE (continued)

1.3. Floor duct 92x20 mm, Cat. No. 0 328 00

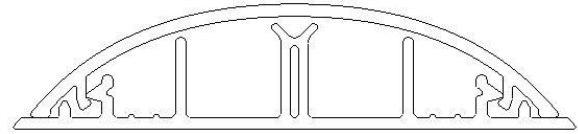

Supplied in lengths of 2m, packs of 20m
 Granite cover.
 Equipped with two adhesive strips for better hold on floor.
 To be cut with saw (metal type saw) and cutting box
 (Cat. No. 0 306 98)
 Body and cover made solid by snap-fitting (removable using tool,
 e.g. screwdriver, etc.)
 4 compartments
 Colour, grey RAL 7016

Overall dimensions:

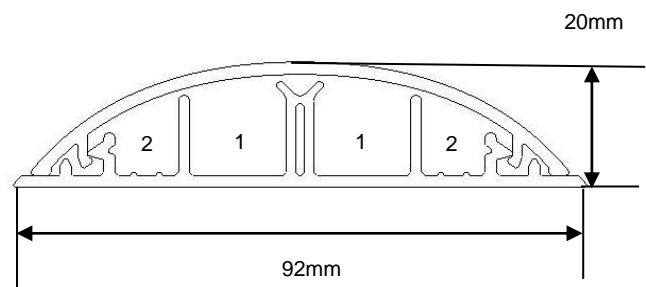

Cabling capacity:

92 x 20 mm	1	2
Section utile en mm ² par compartiment	210	100
∅ 7 mm	4	1
∅ 9 mm	2	1
∅ 11 mm	1	-
Câble ∅ Maxi en mm	14,5	9,5

2. FINISHING COMPONENTS

2.1. Flat angle, Cat. Nos 0 300 11/18 and 0 328 02

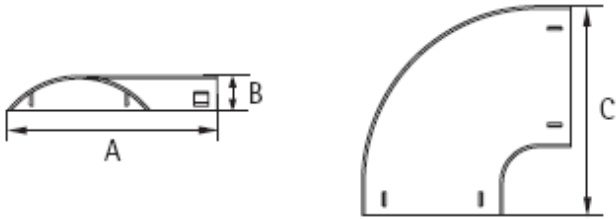

References	For flat angle	Dimensions in mm
0 300 11	50x12 mm	A=53/B=14/C=84
0 300 18	75x18 mm	A=79/B=19/C=116
0 328 02	92x20 mm	A=B=C=

For joining with flat angle two floor ducts of the same cross-section:

- avoids mitre cutting the profile
- compliance with the protection index
- improved styling (cut covered)
- mounting on skirting by snap-fitting
- can be installed after fitting profiles edge-to-edge, the remaining space takes the flat angle's plate

Colours :



- grey RAL 7030 for Cat. Nos 0 300 11/18
- grey RAL 7016 for Cat. No. 0 328 02

Packs :

- 10 for Cat. Nos 0 300 11/18,
- 5 for Cat. No. 0 328 02

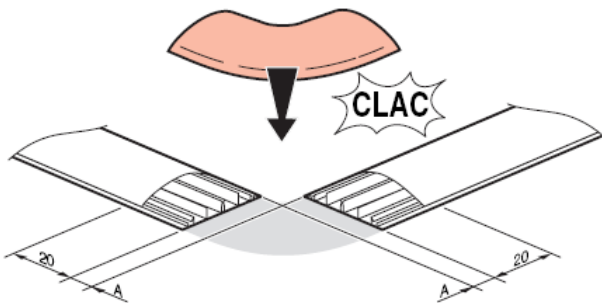
For mounting with floor ducts 50x12 or 75x18mm



	A
 50 x 12 mm	10
 75 x 18 mm	20

For mounting with floor ducts 92x20mm

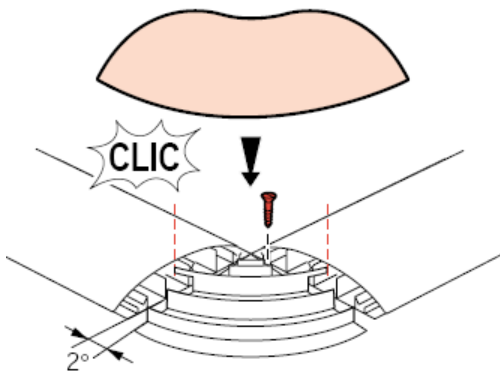

2. FINISHING COMPONENTS (continued)

2.2. Cover joint, Cat. Nos 0 300 11/19 and 0 328 03

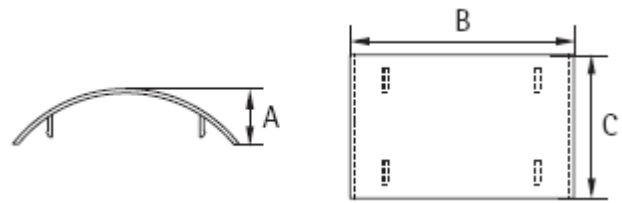

References	For cover joint	Dimensions in mm
0 300 12	50x12 mm	A=14/B=52/C=50
0 300 19	75x18 mm	A=19/B=78/C=50
0 328 03	92x20 mm	A=B=C=

For end-to-end joining of two floor ducts of the same cross-section:

- compliance with the protection index
- improved styling (cut covered)
- mounting on skirting by snap-fitting

Colours :

- grey RAL 7030 for Cat. Nos 0 300 12/19
- grey RAL 7016 for Cat. No. 0 328 03

Packs : 10

For mounting with floor ducts 50x12 or 75x18mm

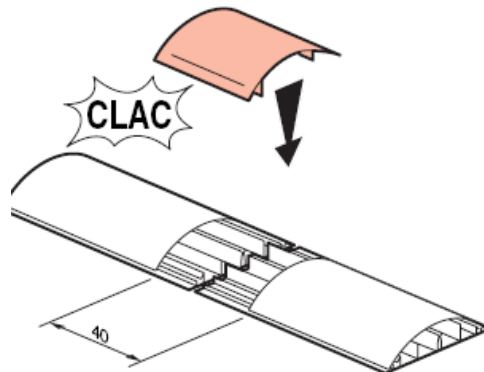

For mounting with floor ducts 92x20mm

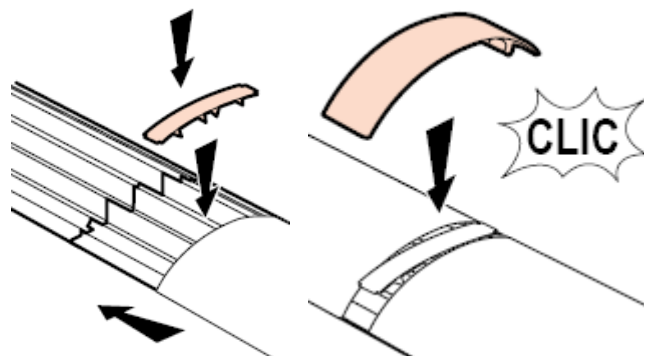

2. FINISHING COMPONENTS (continued)

2.3. Junction box, Cat. Nr 0 328 01



For routing in 4 directions with voltage separation for floor ducts of the same cross-section:

- compliance with the protection index
- improved styling (cut covered)
- screwed floor mounting

Colour, grey RAL 7016
Packs of 5

Overall dimensions:

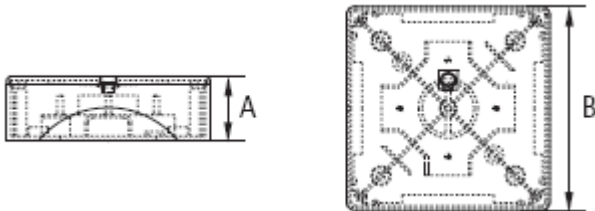

Dimensions :

Reference	Junction box for floor duct	Dimensions en mm
0 328 01	92x20 mm	A=40/B=178

2.4. End cap, Cat. No. 0 328 07

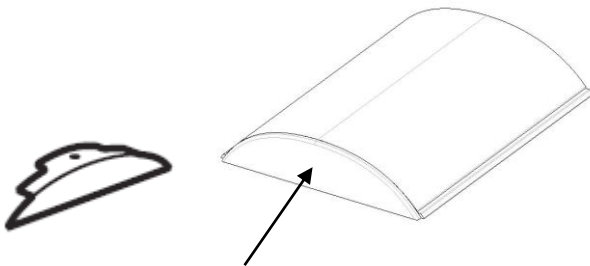

For blanking the end of the floor duct, Cat. No. 0 328 00

- compliance with the protection index
 - improved styling
- Packs of 10

Mounting on profile body from front, by fitting-in and screwing.

Note, no end cap references for floor ducts 50x12 and 75x18mm

Colour, grey RAL 7016

2. FINISHINGCOMPONENTS (continued)

2.5. Connection for skirting mounted mini-trunking 60x20/75x20 mm Cat. No. 0 328 05

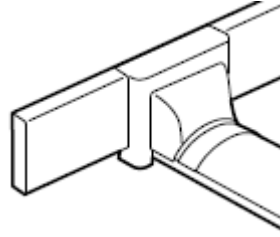

For branching from mini-trunking 60x20/75x20 mm to floor duct
Cat. No. 0 328 00

- compliance with the protection index
 - improved styling (cut covered)
 - mounting on profile by snap-fitting
 - Colour, white RAL 9003
- Packs of 1

2.6. Connection for white skirting-trunking 80/120x20 mm Cat. No. 0 328 06

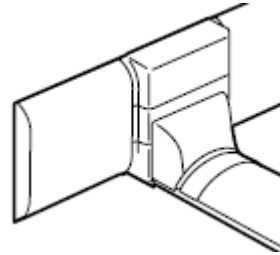

For branching from skirting-trunking 80/120x20 mm to floor duct
Cat. No. 0 328 00

- compliance with the protection index
 - improved styling (cut covered)
 - mounting on profile by snap-fitting
 - Colour, white RAL 9003
- Packs of 1

2.7. Connection for skirting-trunking 140x35 mm Cat. No. 0 328 10

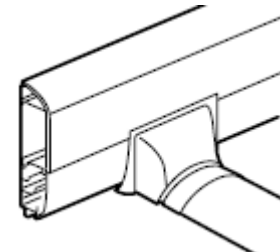

For branching from skirting-trunking 140x35 mm to floor duct
Cat. No. 0 328 00

- compliance with the protection index
 - improved styling (cut covered)
 - mounting on profile by snap-fitting
 - Colour, white RAL 9003
- Packs of 1

2. FINISHING COMPONENTS (continued)

2.8. Branch to floor duct Cat. No. 0 107 71/72/74

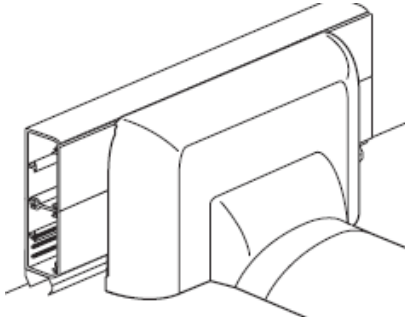

For branching from DLP trunking to floor duct Cat. No. 0 328 00

- compliance with the protection index
- improved styling (cut covered)
- mounting on profile by snap-fitting
- Colour, white RAL 9003
- Packs of 5

For use from DLP to floor duct:

Branches to floor duct Cat. Nos 0 107 71/72/74 must be combined with floor duct extra Cat. No. 0 106 90 (see below)

2.9. Floor duct DLP extra Cat. No. 0 106 90



For completing the branching from DLP trunking to floor duct Cat. No. 0 328 00

- compliance with the protection index
- improved styling (cut covered)
- mounting on profile by snap-fitting
- Colour, white RAL 9003
- Packs of 5

3. IMPLEMENTATION

3.1. Connection from all columns and mini-columns to all references of floor duct

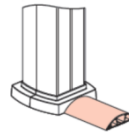

- compliance with the protection index
- improved styling (cut covered)
- mounting on mini-column or column cover by fitting-in

3.2. Connection of floor unit Cat. No. 0 317 48/49 to floor duct Cat. No. 0 328 00

A floor unit can be connected to a floor duct Cat. No. 0 328 00.

Floor unit in single use:

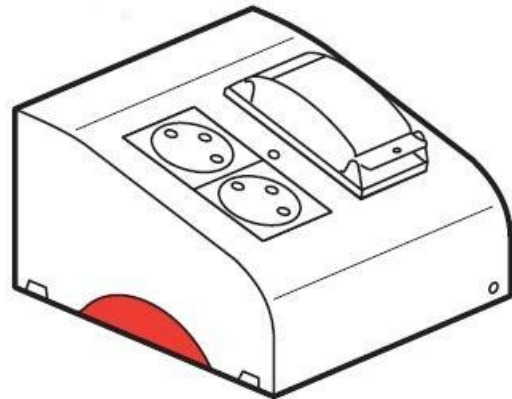

Floor unit combined with floor duct:

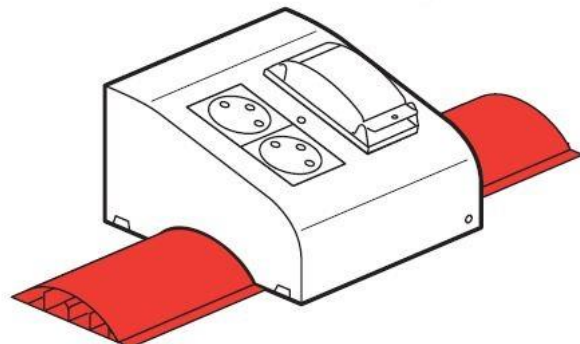

4. TECHNICAL CHARACTERISTICS.

Classification for distribution system by floor standard NF EN 50085-2-2 concerns systems for distributing currents in the floor (sunken or surface-mounted)

6.2 Resistance to impact for installation and application	5J
6.3 Minimum storage and transport temperature	- 25°C
6.3 Minimum installation and application temperature	- 5°C
6.3 Maximum application temperature	+ 60°C
6.4 Resistance to flame propagation	Non propagating
6.5 Electrical continuity characteristics	Without continuity
6.6 Electrical insulating characteristics	With electrical insulating characteristic except ref 0 300 91
6.7 Degree of protection provided by enclosure	IP 20
6.9 System access cover retention	With a tool
6.101 Floor treatment	Dry floor treatment
6.102 Resistance to a vertical load applied over a small surface area	1500N for reference 0 300 92 500N for references 0 300 88/90/91/93 & 0 328 00
6.103 Optional classification according to resistance to a vertical load applied over a large surface area	3000N

Composition and function with distribution system on floor

System	50x12	75x18	92X20
Floor duct	0 30092	0 300 88/90/91/93	0 328 00
Floor duct accessories	Junction box		0 328 01
	Flat angle	0 300 11	0 30018
	Cover joint	0 300 12	0 30019
	End cap		0 328 07
Floor units			0 317 48/49

5. MATERIAL CHARACTERISTICS.

For components (flat angles, end caps, junction boxes, cover joints, branches, adapters, extras)

Family: polyvinyl chloride PVC

Material for floor duct

Family: polyvinyl chloride PVC

- PVC RAL 7030 for ref 0 300 92/0 300 93 and 0 300 91 (only the body of ref. 0 300 91 is in PVC)
- ALUMINIUM for the cover of ref. 0 300 91

- PVC RAL 7016 for ref. 0 328 00
- PVC RAL 9003 for ref. 0 300 88
- PVC RAL 9017 for ref. 0 300 90