

Cam selection for pushbutton selectors

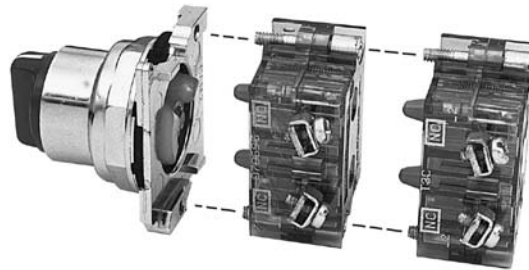

Contents

Description	Page
Cam selection	2
Summary	3
Roto-Push.....	4
Contact block selection.....	5
Three-position selector switch.....	6
Four-position selector switch.....	7
Three-position Roto-Push switch.....	8
Glossary of terms.....	10

Introduction

Selector switches in their varied forms (two-position, three-position, four-position, and Roto-Push) are a big factor contributing to the great flexibility of control that a well-rounded line of "pushbuttons" can achieve.

But because selector switches can be made to perform in such complex and varied ways, selection and application can be difficult. This is only because a well thought-out approach is not readily apparent.

This document provides a time-proven systematic approach that will work in all cases.

Many complex selector switch control schemes have been solved using the methods outlined here. Even if you work with it only occasionally, we ensure that you will be able to easily work out the most complex schemes.

Cam and contact block selection is better understood if you:

- Work with each incoming and outgoing wire (each circuit) separately
- Recognize that the terms NO and NC only identify the type of contact by its mode before mounting it to the operator. The "X-O" chart shows how that contact will act after assembly to the operator with the selected cam shape
- Each cam has two separate lobes, each of which operates one of the two plungers on the contact block independently of each other. Those are identified as position A (top) and position B (bottom). The position designations give direction in selecting and mounting the contact blocks



Powering Business Worldwide

So, the secret of success is a careful, step-by-step analysis of the several elements that make up a complete operating scheme, taking one circuit at a time. Operating schemes that may seem complex at first can be broken down into a series of single circuits that are easy to analyze.

As an exercise, select a switch for one of the most common applications found in motor control, which is the HAND-OFF-AUTO selector switch. In this circuit, one incoming line is distributed to two other outgoing circuits by the switch. These two circuits can each be looked at individually.

The first step is to construct on paper, or in your mind, a simple elementary diagram of the switching scheme as follows:

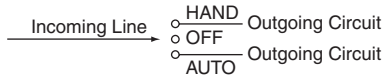

From this, you can construct an "X-O" diagram that describes when the contacts are to be closed (X) or open (O) in the various positions of the switch. The "X-O" for the hand circuits looks like this:

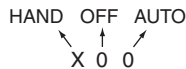

In this circuit, you want a contact closed on the left (hand) but none in the center or the right.

For the automatic (AUTO) circuit, the "X-O" diagram would look like this:

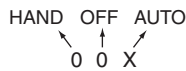

Putting them together, the complete "X-O" diagram is:



Once the "X-O" diagram has been generated, the next step is to select the cam and the contact block or blocks needed to perform the desired "X-O" functions. The selection table listed in Eaton's *Electrical Sector Solutions, Volume 7, CA08100008E*, lists the various types (shapes) of cams by number to choose from and type of contact and position to achieve the function outlined in the "X-O" diagram.

Cam selection

The cam you select determines the operation of all the contact blocks mounted to the operator. It is selected on the basis that it provides the simplest circuitry for the desired "X-O" diagram. For this selection, we publish a chart in our catalog, and other literature, showing all "X-O" combinations. For the purpose of this discussion, the applicable portion of the chart is shown in **Table 1**.

For a complete chart, see **Page 6** and **Page 7**.

Table 1. Selected Portion of Chart

Combination Number	"X-O" Pattern	Cam 2		Cam 3	
		Top Position A	Bottom Position B	Top Position A	Bottom Position B
1	X 0 0				
4	0 0 X				

① Top and bottom circuits are series connected.

To make the cam selection, make a simple worksheet such as:

	Cam 2	Cam 3
X 0 0	ANO - BNC	ANO
0 0 X	BNO	BNO

It becomes immediately obvious that Cam 3 is the better choice for two reasons: (1) the series combination can be avoided, making it simpler to wire, (2) only two contacts are required, which is less expensive than the three contacts required by Cam 2.

Contact block selection

Having selected the cam, contact block selection is simply a matter of gathering the A position and B position circuits into pairs that make up the most convenient contact block arrangement. If there is an imbalance in the number of circuits under A or B, then single circuit blocks must be selected for these leftover circuits.

Back to the worksheet, having selected Cam 3, do this:

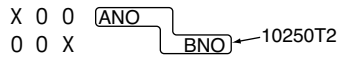

Reference to the contact block listing in the catalog will show this is to be a 2NO contact block, catalog number 10250T2.

For further explanation, suppose your worksheet for some other job came out like this:

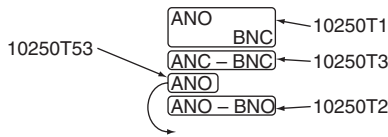

Note: As indicated, this single-circuit contact block must physically be assembled at the end of the stack because it does not have a plunger on the B side to drive the next block.

Selector switch operator

(Refer to Eaton's *Electrical Sector Solutions, Volume 7, CA08100008E*.)

The rest is really easy. You have selected the cam and the contact blocks. Now you have a choice of many operator types (knobs and/or levers in many colors) or key operation with various combinations of maintained and spring return functions.

Select the basic catalog number for the type you want, add the cam number, and you have the complete operator catalog number. For the HAND-OFF-AUTO switch of our example, a knob-operated maintained switch would be catalog number 10250T1323 (the last "3" is the cam you just selected).

The complete switch

The catalog number of the complete HAND-OFF-AUTO selector switch then becomes 10250T1323 with a 10250T2 contact block.

It would be wired like this:

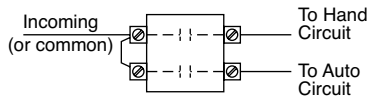

Summary

The following is a review of the selection process.

1. In your mind or on paper, draw the circuit.
2. Take each circuit one at a time and each rotational position of the selector switch one at a time and make your "X-O" chart.
3. Match your chart to the selection chart and make a worksheet using both cams.
4. Select the cam that does it best.
5. Group the contacts under that cam into A and B position pairs and gather the leftover singles.
6. Select the operators and the contact blocks by catalog numbers.
7. Feel confident that any and all control schemes will fall into place using this method.

Note: Frequently used combinations are preselected and set up as stock assemblies for user convenience. The combination used in our example could have been ordered as 10250T21KB prewired with a series jumper. But, by using the system described, many complex circuitry functions can easily be custom ordered from a few stock parts.

A second example

To better understand the process of cam and contact block selection, look at this application in **Table 2**.

Table 2. Example

Circuit	X-O Diagram		
	1	2	3
Circ. 1			
Common	X	0	0
Circ. 2	0	X	0
Circ. 3	0	0	X

From Table 5 and Table 6.

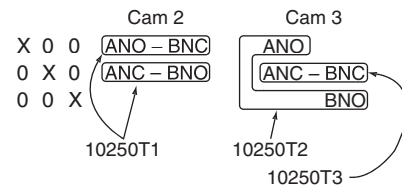

From this selection, the choice would be Cam 3 because it uses contact blocks that can be assembled to the operator with either contact at the top (2NO and 2NC). Although there is nothing wrong with Cam 2 if the top block is assembled with the NO at the top and the second block with the NC out the top.

For Cam 3, the blocks would be wired like this:

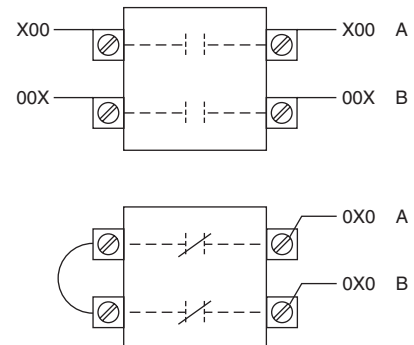

An alternative grouping of the contacts for Cam 2 would avoid the need to consider the orientation.

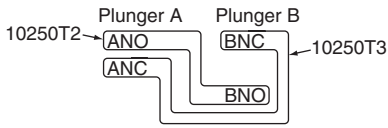

When using this grouping, however, care must be exercised when connecting the jumper from one block to the other. The previous grouping had the jumper connection between the contacts on the same block.

A third example

For this example, we will assume that the desired circuit operation requires the "X-O" diagram shown in **Table 3**.

Table 3. Example

X-O Diagram	Combination Number	Cam 2	
		Position A	Position B
↘ ↑ ↗		BNC ← 10250T51	
X X 0	2	ANC = BNO ← 10250T1	
0 X X	5	BNO ← 10250T5	
0 0 X	4		

When mounting the two single contact blocks, they must be mounted at the end of the stack because they have only one plunger and can not drive a contact mounted behind the blank side.

Operation can be checked visually—the plungers can be seen from the back of the assembly. You can observe the operation of both plungers for different positions of the knob and can check to be sure that both plungers are operating—this will ensure that a double contact block has not been mounted behind a single contact block (one plunger).

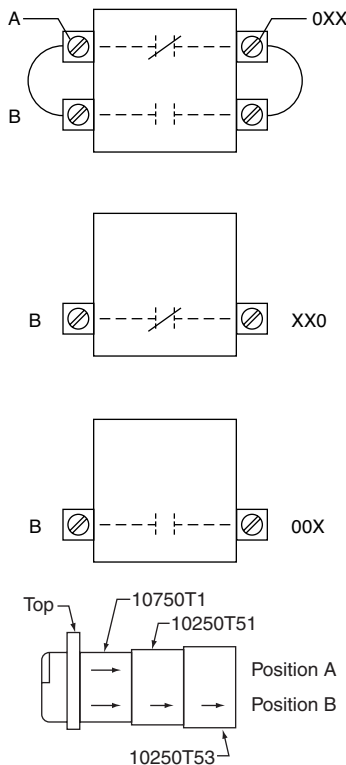

Roto-Push

The Roto-Push is similar to a selector switch except that it has a pushbutton located within a rotatable collar. The collar operates the contacts similar to the knob on the selector switch. The pushbutton may or may not override the action of the collar. The resultant effect is shown in **Table 4**. The chart is the same as that for a selector switch except that an additional column, identified as "D" (for depressed) explains what happens when the button is depressed for that position as opposed to the "N" (not depressed) column, which shows the operation due to the collar position alone. With this simple addition, the selection of the Roto-Push cams and the contact blocks is treated the same as for the selector switches.

Table 4. Example and Portion of Cam Code Chart Affected

Circuit	X-O Diagram						Cam 7		
	Collar Position						Combination Number	Plunger A	Plunger B
	N	D	N	D	N	D			
1	0	X	X	X	X	17	ANO = BNO ← 10250T2		
2	X	0	X	X	X	23	ANC ← 10250T51		
1	0	0	X	X	X	8	ANC = BNO ← 10250T1		

Contact block selection

Maximum number of contact blocks that can be operated by each device is six except as noted in **Table 5**.

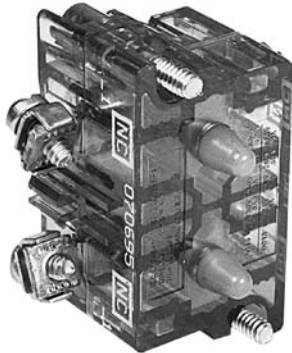

Contact Block with Pressure Terminals

Table 5. Contact Block Selection









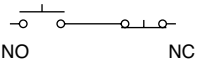
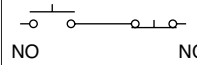

	Circuits ①	Catalog and Code Number		Exceptions to Six Contact Block Maximum Rule		
		Pressure Terminals	Spade Terminals	Four-Position Selection Switch ②	Roto-Push ②	
					Cam 8	Cam 9, 15
	1NC-1NO	10250T1	10250T40	4	2	4
	2NO	10250T2	10250T41	4	2	4
	2NC	10250T3	10250T42	4	2	4
	1LONC	10250T55	—	—	2	4
	1ECNO	10250T55	—	—	2	4
	1ECNO	10250T57	—	—	2	4
	1NO	10250T57	—	—	2	4
	1NC	10250T51	10250T59	4	2	4
	1NO	10250T53	10250T60	4	2	4

① NO = Normally Open
NC = Normally Closed
ECNO = Early Closing Normally Open
LONC = Late Opening Normally Closed

② All other cams—six blocks maximum.

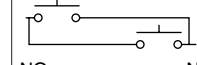
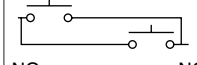
Three-position selector switch

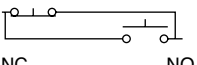
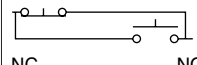
Table 6. Three-Position Selector Switch—Cam and Contact Block Selection

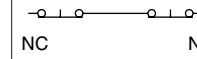
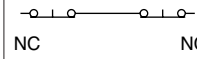
Combination Number	Desired Circuit Operation X = Circuit Closed O = Circuit Open ①			Contact Blocks Required to Accomplish Circuit Function (Jumpers must be installed where indicated) ②			
				Operator with Cam Code 2 ③		Operator with Cam Code 3 ③	
				Mounting Location		Mounting Location	
				Top Plunger A	Bottom Plunger B	Top Plunger A	Bottom Plunger B
1	X	O	O	 NO NC	 NO NC	 NO	—
2	X	X	O	—	 NC	—	 NC
3	X	O	X	 NO	—	 NO NO	 NO NO
4	O	O	X	—	 NO	—	 NO
5	O	X	X	 NC NO	 NC NO	 NC	—
6	O	X	O	 NC	—	 NC NC	 NC NC

① Construct X, O patterns from line diagram of circuit as described on **Page 1**.

② Circuits shown illustrate connections to obtain a selector circuit combination and are not normally shown in line diagrams. The connections are not made at the factory and appear in the tables as requirements that must be made on the job.

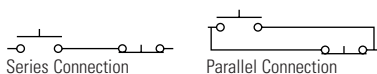

③ Select cam code giving simplest contact block arrangement for circuit(s) required.

Four-position selector switch

Table 7. Four-Position Selector Switch—Contact Block Selection

Combination Number	Desired Circuit Operation X = Circuit Closed O = Circuit Open ①				Contact Blocks Required to Accomplish Circuit Function ②③		Combination Number	Desired Circuit Operation X = Circuit Closed O = Circuit Open				Contact Blocks Required to Accomplish Circuit Function ②③	
	Mounting Location				Top Plunger A	Bottom Plunger B		Mounting Location				Top Plunger A	Bottom Plunger B
1	X	O	O	O		—	10	X	O	X	O		—
2	O	X	O	O	—								
3	O	O	X	O		—	11	X	X	X	O		
4	O	O	O	X	—								
5	X	O	O	X			12	O	X	X	X		
6	O	X	X	O									
7	O	O	X	X			13	X	O	X	X		
8	X	X	O	O									
9	O	X	O	X	—		14	X	X	O	X		

① Construct X, O patterns from line diagram of circuit as described on Page 1.

② Circuits shown illustrate connections to obtain a selector circuit combination and are not normally shown in line diagrams. The connections are not made at the factory and appear in the tables as requirements that must be made on the job.

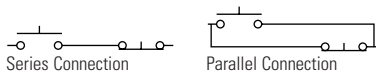

③ Jumpers must be installed where indicated.

Three-position Roto-Push switch



Roto-Push Operator Assembled with Contact Block

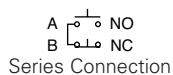

Note: The connections are not made at the factory. They are illustrated in the selection table as requirements, but must be made on the job.

Table 8. Three-Position Roto-Push Switch—Cam and Contact Block Selection

Combination Number	Circuit Sequence ①			Cam Code 7	Cam Code 8 ②	Cam Code 9	Cam Code 15	Cam Code 16	Cam Code 17	Cam Code 18
	N D	N D	N D							
1	0 0	0 0	0 X			—			—	
2	0 0	0 0	X X	—	—		—	—		—
3	0 0	0 X	0 0	—	—		—	—	—	
4	0 0	0 X	0 X	—	—	—	—	—	—	—
5	0 0	0 X	X X	—	—		—	—	—	—
6	0 0	X X	0 0	—		—	—	—	—	—
7	0 0	X X	0 X	—		—	—	—	—	—
8	0 0	X X	X 0		—	—	—	—	—	—
9	0 0	X X	X X		—	—	—	—	—	—
10	0 X	0 0	0 0	—		—				
11	0 X	0 0	0 X		—	—			—	—
12	0 X	0 0	X X	—	—	—	—	—		—
13	0 X	0 X	0 0	—	—	—	—	—	—	
14	0 X	0 X	0 X	—	—	—	—	—	—	
15	0 X	X X	0 0	—		—	—	—	—	—
16	0 X	X X	0 X	—		—	—	—	—	—
17	0 X	X X	X X		—	—	—	—	—	—
18	X 0	0 0	0 0		—	—	—	—	—	—
19	X 0	0 0	X X	—		—	—	—	—	—
20	X 0	0 0	X 0	—		—	—	—	—	—
21	X 0	X X	0 0	—	—	—	—	—		—
22	X 0	X X	X X			—	—			

① N = Button in free or normal position.
D = Button depressed.

② Limited to two contact blocks.

③ Contacts open at reduced arc gap (for use on AC only).

Table 8. Three-Position Roto-Push Switch—Cam and Contact Block Selection, Continued

Collar Position

↙ ↑ ↘

Combination Number	Circuit Sequence ①			Cam Code 7	Cam Code 8 ②	Cam Code 9	Cam Code 15	Cam Code 16	Cam Code 17	Cam Code 18
	N	D	N D							
23	X	0	X X	X 0	—	—	—	—	A NC B NC	—
24	X	0	X 0	X 0	—	—	—	A NC B NC	—	A NC B NC
25	X	0	X 0	X X	—	—	—	A NC ③	—	A NC
26	X	X	0 0	0 0	B NC	—	A NC ③	—	—	—
27	X	X	0 0	0 X	A NC B NO	—	—	—	—	—
28	X	X	0 0	X 0	—	B NC	—	—	—	—
29	X	X	0 0	X X	—	A NC B NC	A NC ③ B NO	—	—	—
30	X	X	X X	0 0	—	—	B NC	—	A NC	—
31	X	X	X X	X 0	A NC B NC	A NO B NC	—	B NC	—	A NO B NC
32	X	X	X 0	X 0	—	—	B NC ③	—	—	B NC
33	X	X	X 0	X X	—	—	A NO ③ B NC	—	—	A NC B NC

① N = Button in free or normal position.
D = Button depressed.

② Limited to two contact blocks.

③ Contacts open at reduced arc gap (for use on AC only).

Glossary of terms

Cam



As the cam is rotated, the following occurs:

- 1 – Plunger in free position
- 2 – Plunger depress 1/2 way
- 3 – Plunger fully depressed

A cam is a circular inclined plane with a specific shape (or slope) that rides against the contact block plungers so that the rotary motion of the knob or the lever depresses the plungers in the same manner as a pushbutton. Each cam has two lobes, referred to as lobe A and B, each of which operates one of the two contact block plungers independently, thereby opening or closing the respective contacts. This opens or closes the contacts at the prescribed rotary position of the knob. Cams are permanently attached so that they cannot be accidentally changed in use. A selected cam and contact block combination will give the electrical function shown in the “X-O” chart (for example, X O O contact closed in left rotation, open in the other two rotation stop positions).

If X O O resulted from using an NC (normally closed) contact, you might expect an NO contact to be O X X, but this is sometimes not so because the O might be an NC contact 1/2 way open, in which case a NO 1/2 way closed is also an O.

Cam code

This applies to Roto-Push operators and refers to a particular combination of a cam and a push plate. Two different cam codes might use the same cam or push plate.

Contact blocks

A contact block is the device that contains the electrical contacts. It may contain a single or multiple circuit. Selector switches and Roto-Push pushbuttons use the same contact blocks as standard pushbuttons. The designations NO and NC describe the contacts before the block is mounted on the operator. Mounting a contact block to the operator may immediately change the mode of the contact (open to closed or closed to open) depending on the shape of the cam and the rotational position of the operator. The terms NO and NC then refer to the type of contact before mounting on the operator and are not to be confused with the function of the contact after mounting to the operator. So, the contact state is determined not only by the type of the contact (NO or NC), but also by the operator cam shape. Refer to the “Cam and Contact Block Selection Chart” for the opening and closing sequence of the contacts with differently shaped cams on the operator.

Position A and Position B

The TOP of the operator is defined by the position of the locating nib on the front of the operator. On selector switch operators, the word TOP is molded into the back of the operator to further locate it. On Roto-Push operators, the locating nib alone serves to orient the device. When a contact block is assembled to the operator, the top contact becomes circuit A (acted upon by the A lobe of the cam) and the bottom contact is then circuit B. Because the contact blocks are symmetrical, either contact can be mounted in the A or B position. In the case of a 2NO or 2NC contact block, it will make no difference how it is mounted, but an NO-NC or a single NO or NC must be mounted so that the correct contact is in the A and/or B position.

A NO, A NC, B NO, B NC

Convenient shorthand for NO and NC contacts positioned to be operated by cam lobe A or B.

A NO—B NC

This is a shorthand method of writing “a normally open contact in the A position and wired in series with a normally closed contact in the B position,” etc.

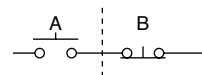

A NO = B NC

This is a shorthand method of writing “a normally open contact in the A position and wired in parallel with a normally closed contact in the B position,” etc.

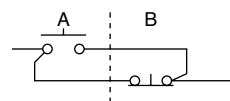

X-O diagram

A representation of the open or closed state of a circuit for each rotational position of the selector switch. A circuit consists of one or more double break contacts. Where multiple contacts are used for a single circuit, they will be wired in either series or parallel or both to achieve the specified function pattern. X indicates a closed circuit state. O indicates an open circuit state.

Combination number

Convenient designations for particular “X-O” patterns for convenience of communication. There is no correlation between combination number or cam numbers used on different operators.

N

A Roto-Push term indication that the button is in normal (non-depressed) position.

D

A Roto-Push term indicating that the button is depressed.

Eaton Corporation
Electrical Sector
1111 Superior Avenue
Cleveland, OH 44114 USA
Eaton.com

© 2013 Eaton Corporation
All Rights Reserved
Printed in USA
Publication No. TD04703002E / Z13309
February 2013



Eaton is a registered trademark
of Eaton Corporation.

All other trademarks are property
of their respective owners.