

# SQUARE D Instruction Bulletin

Bulletin No. 50006-365-14

April, 1994

Raleigh, NC, U.S.A.

## Contactors and Reversing Contactors LC1/LC2- D40..D80

### INTRODUCTION

This Instruction Bulletin illustrates reversing contactors, interface modules and mounting. All other pertinent information is located inside the enclosure.



## DANGER

#### HAZARDOUS VOLTAGE.

Disconnect all power before working on equipment.

Electrical shock will cause severe injury or death.

#### TENSION DANGEUREUSE.

Coupez l'alimentation avant de travailler sur le produit.

Electrocution peut causer de sévères blessures ou la mort.

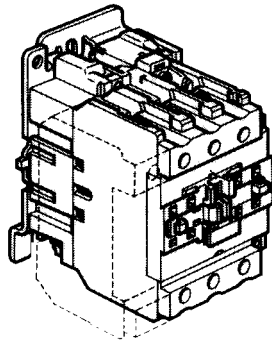

LC1 D40  
LC1 D50  
LC1 D65  
LC1 D80

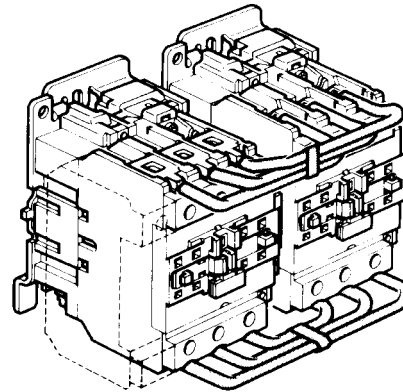

LC2 D40  
LC2 D50  
LC2 D65  
LC2 D80

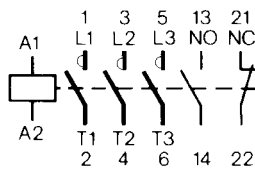

D4011/D5011  
D6511/D8011

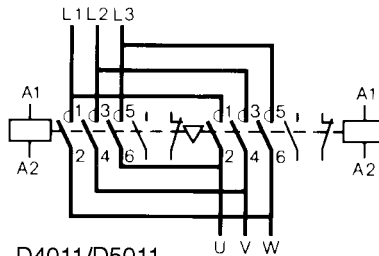

D4011/D5011  
D6511/D8011

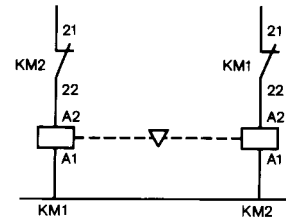
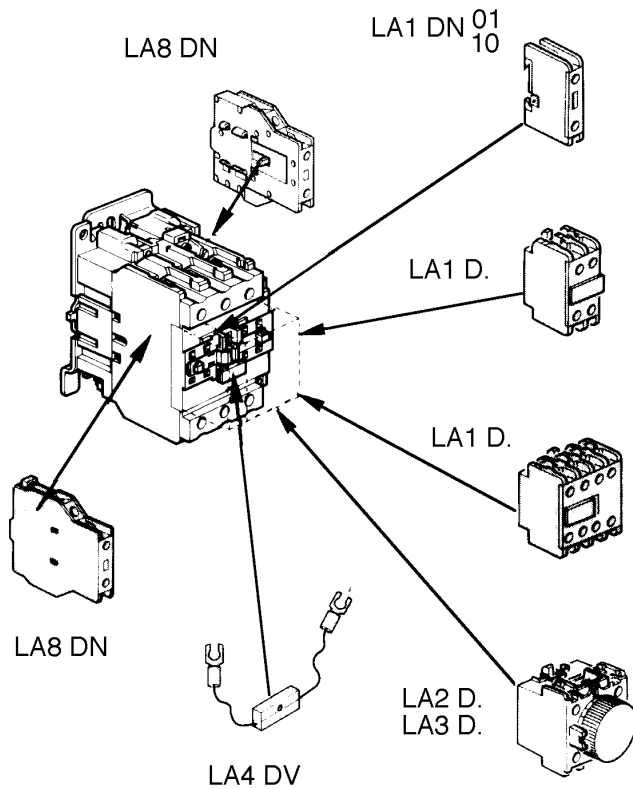

Figure 1 AC Contactors, Reversing Contactors and Power Connections

Table 1 Selecting Interface Modules for Contactors and Reversing Contactors

LC1/LC2		VOLTAGE RANGE	LA1 D• LA2 D• LA3 D• LA6 D•	LA8 DN		
LC1 D40...D80 LC2 D40...D80	50-60 Hz	80 to 110%	•			
		85 to 110%	•	•	•	
	50 Hz 60 Hz	80 to 110%	•	•	•	•
			•	•	•	•



(1) Refer to Interface Modules and Accessories  
 (2) Refer to Figure 4 for Mounting

AUXILIARY CONTACTS

LA1 DN10	1NO
LA1 DN01	1NC
LA1 DN11	1NO +1NC
LA1 DN20	2NO
LA1 DN02	2NC
LA1 DN22	2NO+2NC
LA1 DN13	1NO+3NC
LA1 DN40	4NO
LA1 DN04	4NC
LA1 DN31	3NO+1NC
LA1 DC22	2NO +2NC
LA1 DX20 (1)	2NO
LA1 DZ40 (1)	2NO+2NO
LA1 DZ31 (1)	1NO+1NC +2NO
LA1 DY20 (1)	2NO
LA8 DN11 (2)	1NO+1NC
LA8 DN20 (2)	2NO

PILOT LIGHT

LA4 DV (2)	
------------	--

TIMING DELAY

LA2 DT0	0.1 to 3 sec	
LA2 DT2	0.1 to 30sec	
LA2 DS2	1 to 30 sec	
LA2 DT4	10 to 180 sec	
LA3 DR0	1 to 3 sec	
LA3 DR2	1 to 30 sec	
LA3 DR4	100 to 180 sec	

**Figure 2 Interface Modules**

**INTERFACE MODULES AND ACCESSORIES**

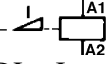
- LA1 DX/DY/DZ - Dust Tight
- LA6 DK -  Mechanical Latch "Coil"
- LA4 DF/DW/DL - Interface Modules "Amplifier"
- LA4 DA/DE - Coil Suppressors
- LA4 DM - Three position accessory (Auto O Man)
- LA4 DT/DR - Delay on coil, energizing or de-energizing

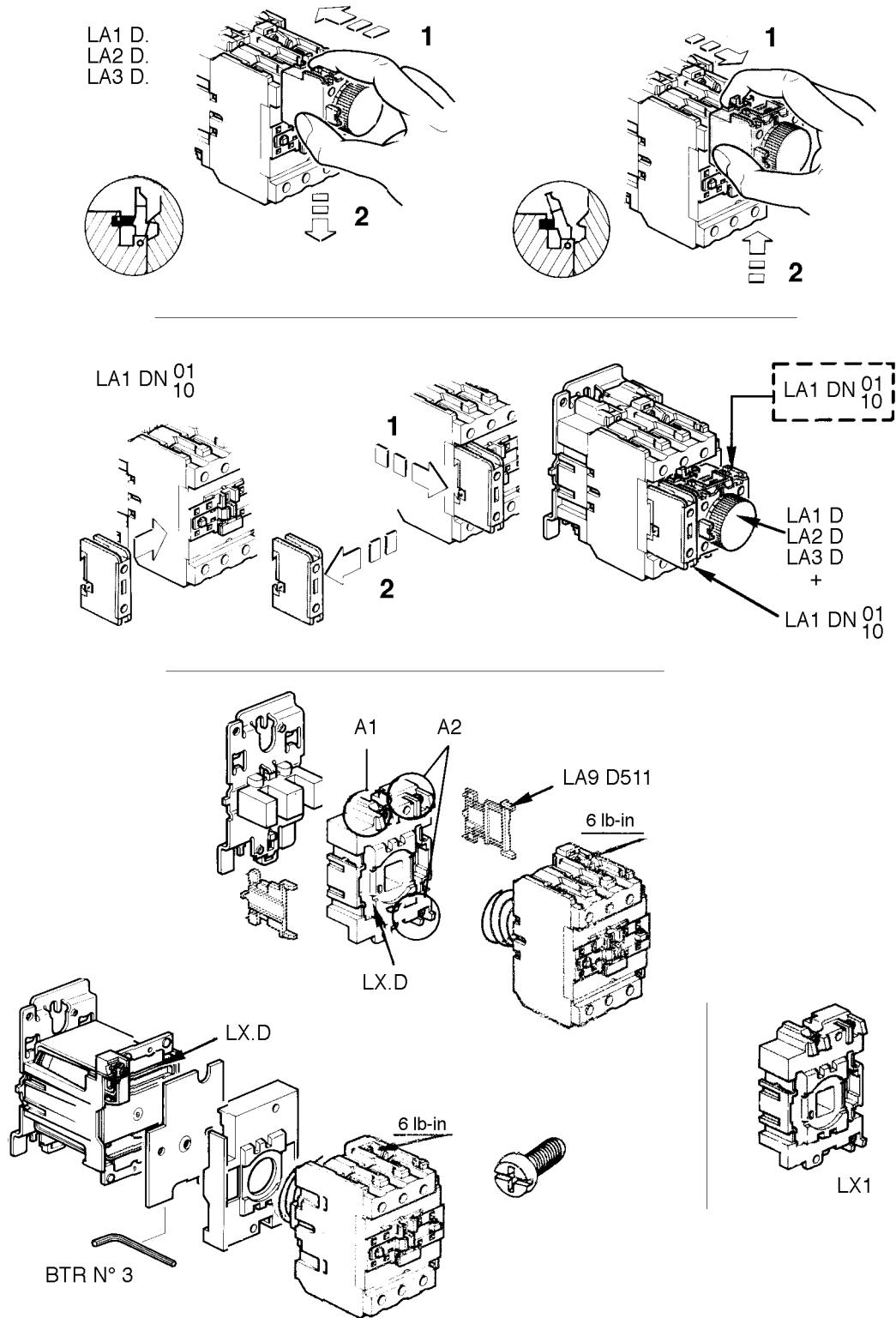

**Figure 3** Mounting Auxiliary Contact Block to Contactors and Replacement of Coil

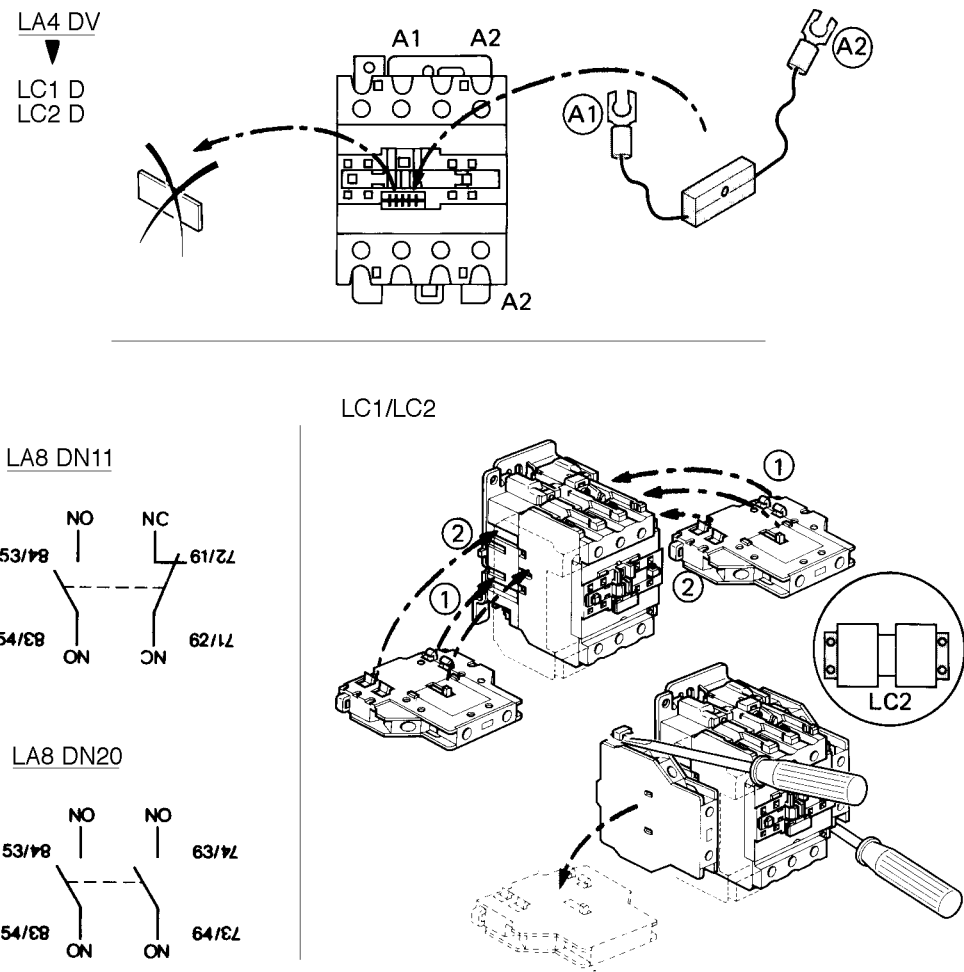

**Figure 4** Mounting of Side Mounted Auxiliary Contact Block and Pilot Light to Contactor

**PLEASE NOTE:** Electrical equipment should be serviced only by qualified electrical maintenance personnel, and this document should not be viewed as sufficient instruction for those who are not otherwise qualified to operate, service or maintain the equipment discussed. Although reasonable care has been taken to provide accurate and authoritative information in this document, no responsibility is assumed by Square D for any consequences arising out of the use of this material.

**NOTA:** L'entretien doit être effectué par du personnel qualifié. Notez que ce bulletin ne contient pas d'instruction suffisante pour les personnes qui n'ont pas la qualification requise pour intervenir sur ces équipements. Bien que tout le soin nécessaire ait été apporté à la rédaction de ce bulletin afin qu'il fournisse des informations exactes et précises, Square D décline toute responsabilité quant aux conséquences éventuelles qui pourraient subvenir suite à l'utilisation de ce matériel.