

CLIPSAL[®]
LIVING ELECTRICAL

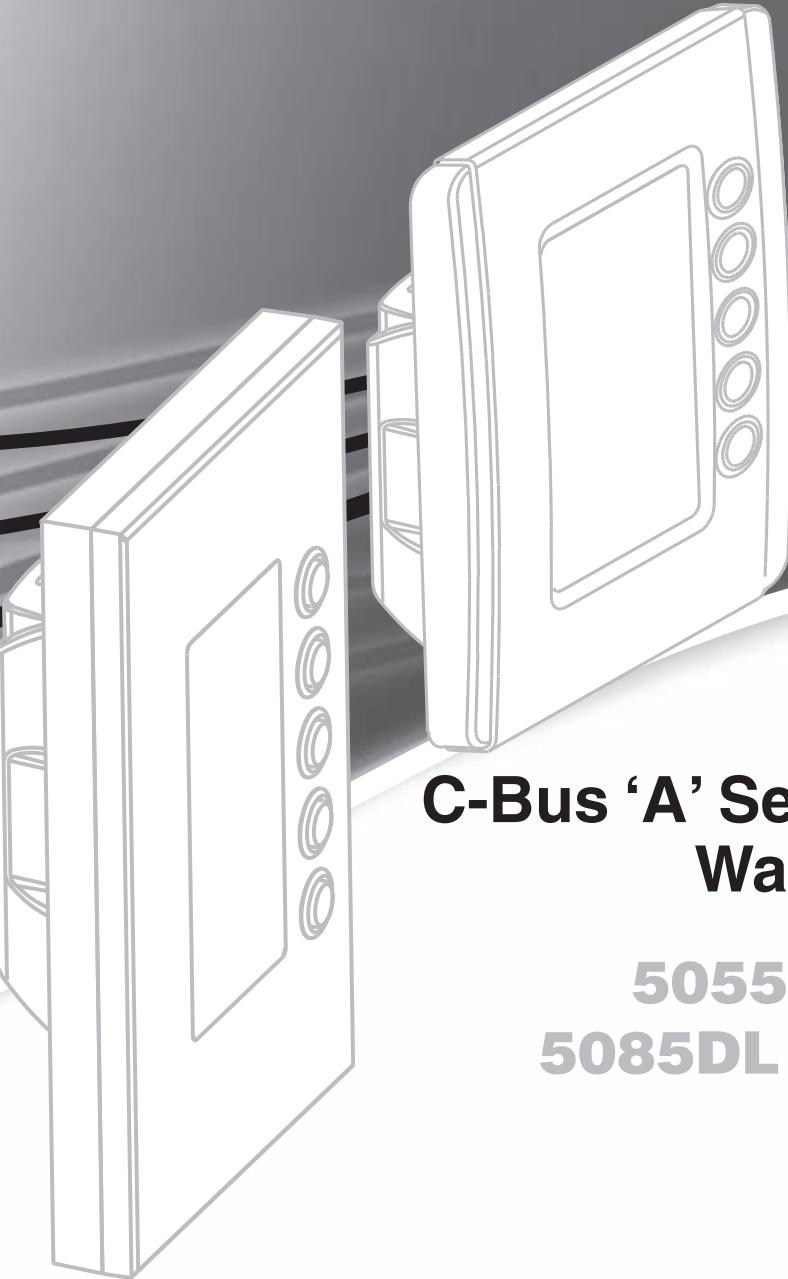

C-Bus[®]
**C-Bus 'A' Series DLT
Wall Switch**

5055DL Neo[®]
5085DL Saturn[™]
Series



User's Guide

Clipsal and C-Bus are registered trademarks of Clipsal Australia Pty Ltd.

Neo is a registered trademark of Clipsal Australia Pty Ltd.

Saturn is a trademark of Clipsal Australia Pty Ltd.

©Copyright Clipsal Australia Pty Ltd, 2008. All rights reserved. This material is copyright under Australian and international laws. Except as permitted under the relevant law, no part of this work may be reproduced by any process without prior written permission of and acknowledgement to Clipsal Australia Pty Ltd.

The information in this manual is provided in good faith. Whilst Clipsal Australia Pty Ltd (CAPL) has endeavoured to ensure the relevance and accuracy of the information, it assumes no responsibility for any loss incurred as a result of its use. CAPL does not warrant that the information is fit for any particular purpose, nor does it endorse its use in applications that are critical to the health or life of any human being. CAPL reserves the right to update the information at any time without notice.

Contents

1.0	Product Range	5
2.0	Description	5
3.0	Care Instructions	6
4.0	Definitions	6
5.0	Basic Operation	7
6.0	Setting the Time	9
7.0	Learn Mode	10
	7.1 Creating a Group	11
	7.2 Using Timers	12
8.0	Scenes	13
	8.1 Creating a Scene Control	13
	8.2 Recording a Scene	14
9.0	Specifications	15
10.0	Limited Warranty	15

1.0 Product Range

This user's guide describes the following 'A' Series DLT 5-button wall switches with rectangular plates:

Catalogue Number	Description
5055DL	C-Bus 'A' Series DLT Wall Switch, Neo style
5085DL	C-Bus 'A' Series DLT Wall Switch, Saturn style

Several fascia styles for 'A' Series DLT can be ordered. Consult the current catalogue or contact your local Clipsal sales representative.

2.0 Description

C-Bus 'A' Series Neo and Saturn DLT input units are a range of high end C-Bus switches with Dynamic Labelling Technology (DLT). Units feature 5 physical buttons that control up to 8 control groups. The LCD interface displays labels and status information for each button/control group. Units have scene management and learn mode capability.

Labels can consist of text (in several languages) or graphics. To reflect a change in functionality, you can change them dynamically using other C-Bus devices, such as the C-Bus Multiroom Audio System.

Learn mode enables you to create associations between buttons on input units such as the DLT, and loads on output units such as dimmers. It allows you to add functionality such as timers and scenes.

Scene capability allows you to perform a series of actions across multiple outputs by pressing a single button. For example, on arrival home you could use a scene to switch on lights in the hallway and kitchen, dim lights in the lounge, and switch on a heater.

Using special software, C-Bus DLT units can be programmed so their controls can be enabled and disabled (locked) from another C-Bus unit.

3.0 Care Instructions

The C-Bus DLT units contain electrical and electronic parts. Be sure to follow these precautions:

- The C-Bus DLT range is designed for indoor use only.
- Do not use hard, sharp objects to select the controls.
- Do not use spray cleaners or chemicals to clean the DLT unit.
- Use only a soft cloth for cleaning.



no wet hands



no cleaner spray



no coverage



no direct sunshine



no dust

4.0 Definitions

Term	Definition
load	An electrical device connected to mains voltage via a C-Bus output unit. Examples include lights, AC power points, heaters and electric motors.
scene	A series of actions across multiple outputs, triggered by a single button. For example, on arrival home you could use a scene to switch on lights in the hallway and kitchen, dim lights in the lounge, and switch on a heater.
learn mode	A configuration state of a network that contains C-Bus2 units. Learn mode enables you to create associations between buttons on input units such as the DLT, and loads on output units such as dimmers. It allows you to add functionality such as timers and scenes.
quick-press	A brief button press (pressed for a fraction of a second).
double quick-press	Two quick-presses in quick succession.

5.0 Basic Operation

A C-Bus 'A' Series Neo or Saturn DLT input unit has 5 buttons which control up to 8 control groups. The upper 4 buttons operate the control groups on the active page. The fifth button alternates between pages (two pages of up to 4 control groups each) and is used to set the time and date. This is illustrated in Figure 1.

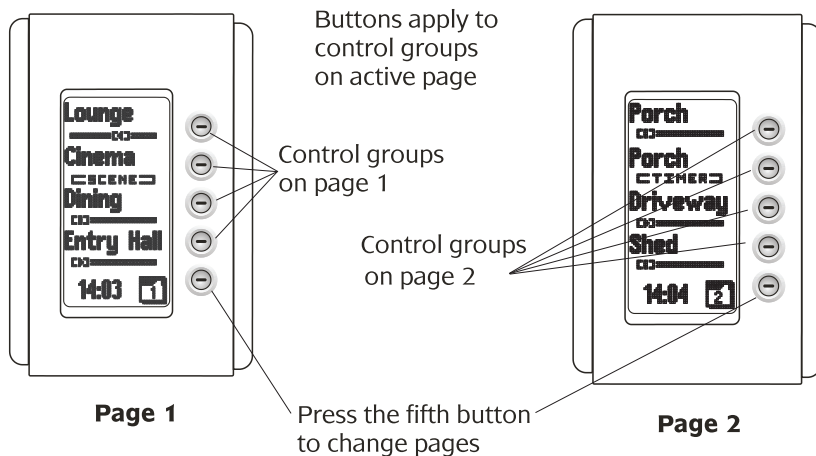

Figure 1. An 'A' Series DLT unit has two pages, each with four control groups

The DLT interface consists of an LCD display that provides information and feedback about the groups the unit controls. This includes:

- a label for each control group
- a bar below each label indicating the control type and level (such as a SCENE or dimmer slider)
- the current page number
- the time (if enabled).

Some interface examples are provided in Figure 2, together with descriptions.

Normally, special software is used to configure a C-Bus DLT unit when it is installed. This configuration tells the unit which button controls what. It is also possible to configure the unit using learn mode, which is described in section 6.0.

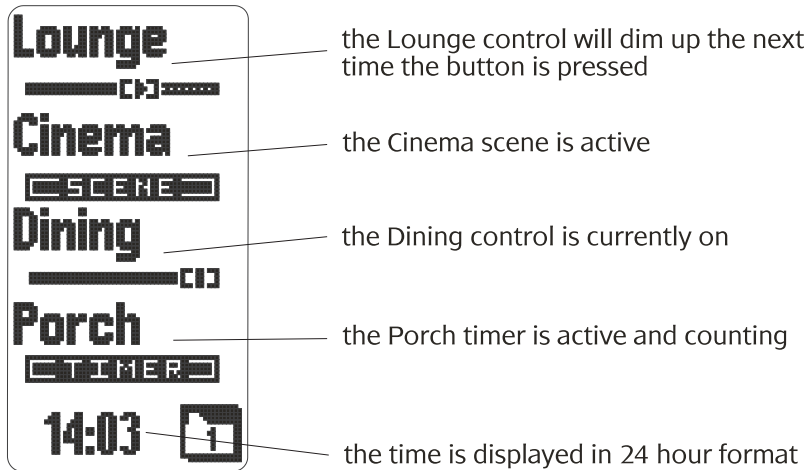
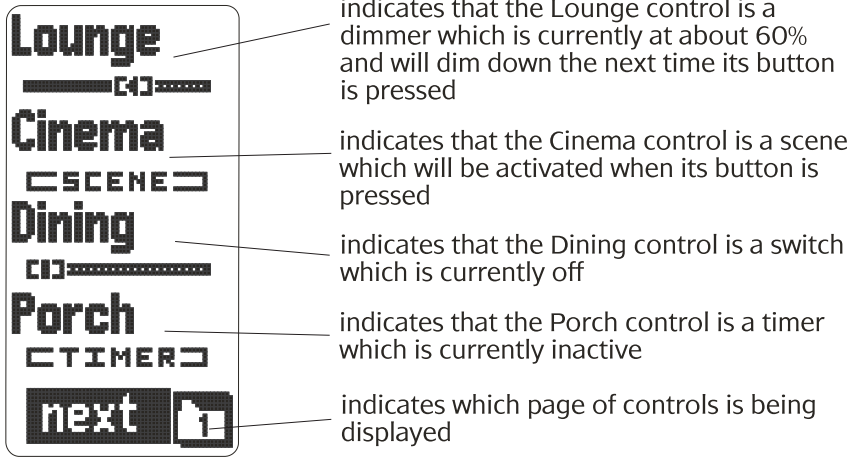

Figure 2. Identification of the DLT interface

6.0 Setting the Time

C-Bus DLT input units contain a clock. The time is displayed at the base of the display when the clock is enabled and the time has been set. You can set the time from the DLT unit, or from certain other control units such as the C-Bus Colour Touch Screen. Setting the time on a DLT enables the clock on that unit. It also sets the time on other C-Bus units that have their clocks enabled and reside on the same C-Bus network.

Figure illustrates how to set the time on a DLT unit:

- 1) Hold down the fifth (bottom-most) button for 10 seconds, until the display changes to time set mode.
- 2) Adjust the time. Press the Select (top) button to select which time property to adjust (hour or minute). The + and - (second and third) buttons increment and decrement the selected time property. Note that the time is displayed in 24-hour format, where 14:00 is equivalent to 2:00 pm.
- 3) Press the OK (bottom-most) button to exit clock set mode.

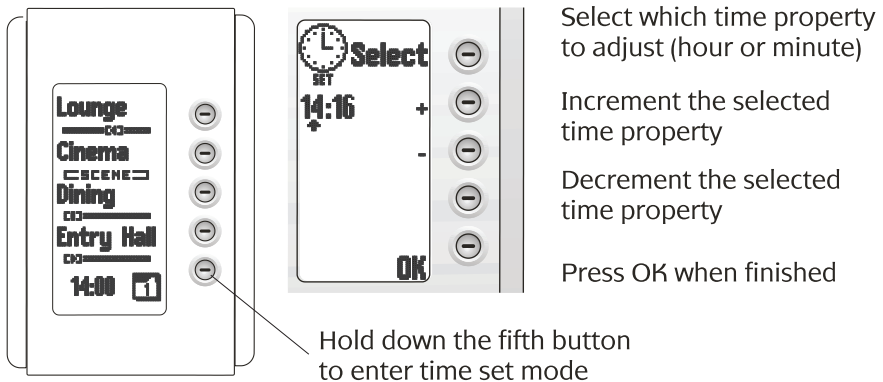

Figure 3. Setting the time



You will need to set the time again after a power failure. This may not be necessary if a control unit capable of restoring the time is present on the C-Bus network (such as the C-Bus Colour Touch Screen).

7.0 Learn Mode

A C-Bus network consists of various C-Bus units that are connected together. Some of these are input units such as wall switch buttons or infrared sensors that send messages over the network. Others are output units that control lights and other devices in response to messages they receive over the network.

In a C-Bus network, associations are created between input and output units. These associations are called groups. A group typically associates one or more buttons on a switch (input) unit, with one or more channels on a dimmer or relay (output) unit. (Most output units can control multiple loads, each of which is referred to as a channel).

The example in Figure 4 shows two groups that could exist in a C-Bus network. Button 1 of the Neo is grouped with channel 2 of the Relay unit. Button 2 of the Neo is grouped with the PIR and channel 1 of the Relay.

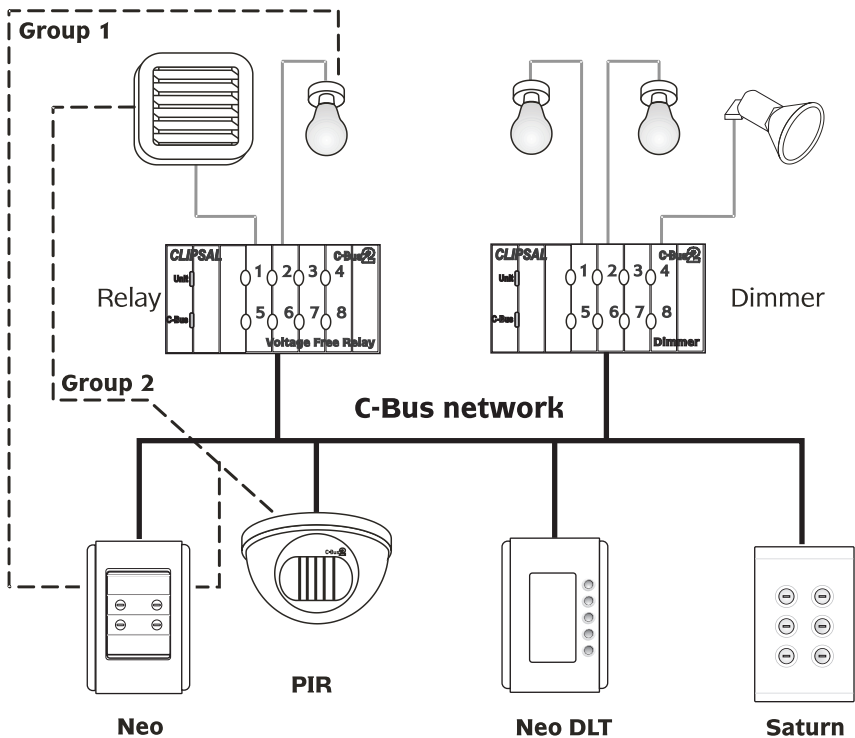

Figure 4. A typical C-Bus network

Groups can be created between C-Bus2 units using learn mode. To enter learn mode, press and hold a button on a C-Bus2 output unit for 10 seconds. When in learn mode, you can perform the following functions on a C-Bus DLT unit:

- group a single DLT control group with inputs and outputs on other units
- group a pair of DLT controls with inputs and outputs on other units
- include a timer function in a control group (single or pair)
- create a scene control

7.1 Creating a Group

The example in Figure 5 shows the creation of a group which includes channel 3 of a dimmer (output) unit, control group 2 of a DLT (input) unit, and button 2 of a standard Saturn (input) unit. The result is that the light or other appliance connected to channel 3 of the dimmer, can be controlled from both the DLT and standard Saturn unit.

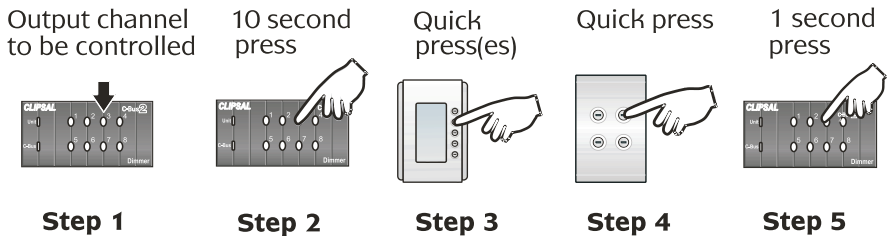

Figure 5. Creating a group including a dimmer, DLT and Saturn unit

To group a DLT control group with a C-Bus2 output or other inputs:

- 1) Go to the output unit you want the DLT unit to control.
- 2) Hold down the button corresponding with the channel you want to control for 10 seconds. The "Unit" and "C-Bus" indicators will flash alternately, the selected output channel will switch on, and all other C-Bus outputs in the same network will switch off.
- 3) Select the control group on the DLT unit that you want to include in the group. Use the buttons to select and deselect control groups. Press the fifth button to alternate between pages 1 and 2.

The Toggle/Dimmer function is assigned when you select a single control group. If you select two control groups on the same unit,

- the first one you select uses the On+Up and the second uses the Off+Down function. This allows a pair of buttons to control a group; one to switch on/dim up, the other to switch off/dim down.
- 4) Select any additional input unit buttons or output unit channels you want to include in the group.
 - 5) Press and hold a button on a C-Bus2 output unit for 1 second, to exit learn mode.

7.2 Using Timers

When using learn mode to create a group, you can set a control group to work as a timer. You do this by holding a button down when selecting a control group (instead of using a quick press). The display will identify the function as Timer and show the timer period (see Figure). As you continue to hold, the period increases until you release the button. The timer period can be set to 5 seconds, or from 5 minutes to 10 hours and 35 minutes (in 5 minute intervals).



When adding to a group in learn mode, press and hold to create a timer

Figure 6. Creating a timer

8.0 Scenes

A scene allows you to perform a series of actions across multiple outputs by pressing a button. For example, on arrival home you could use a scene to switch on lights in the hallway and kitchen, dim lights in the lounge, and switch on a heater.

A C-Bus DLT unit can have up to eight scenes, depending on how many groups they control. Up to four scenes may be created using learn mode, any additional scenes must be programmed using special software. Scenes may control up to 40 groups in total, with up to 10 groups per scene.

There are two stages of creating a scene:

- 1) You must create a scene control group. This is used to trigger the scene. Any of the eight DLT control groups can be used as a scene control.
- 2) You must record the scene. This involves setting states of the buttons you want to be recalled, and assigning these to the scene control.

8.1 Creating a Scene Control

A scene control is created by double quick-pressing a DLT button in learn mode:

- 1) Activate learn mode by holding down a button on a C-Bus2 output unit for 10 seconds. The 'Unit' and 'C-Bus' indicators will flash alternately, the selected output channel will switch on, and all other C-Bus outputs in the same network will switch off.
- 2) Quick-press the same button again to switch it off.
- 3) Double quick-press one of the first four buttons on the DLT. The SCENE function type will display, together with the control group numbers that are set as scene controls.
- 4) Press the DLT buttons to select and deselect which control groups you want to use as scene controls.
- 5) Press and hold a button on a C-Bus2 output unit for 1 second, to exit learn mode.

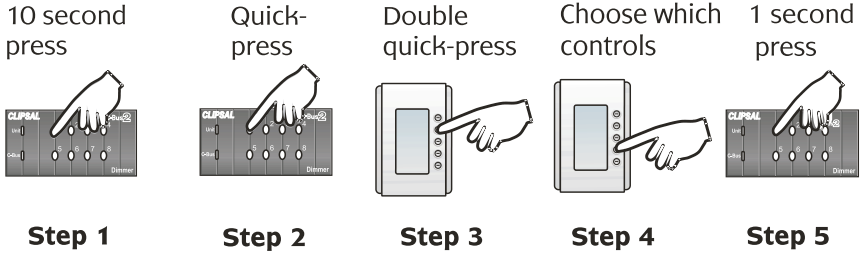

Figure 7. Creating a scene control

8.2 Recording a Scene

Once a scene control has been created, you can use it to capture the states of lights and other devices connected to the C-Bus network. These states can then be recalled using the scene control.

The following steps are illustrated in Figure . To capture the states of lights and other appliances (record a scene):

- 1) On the DLT unit, press and hold the button that corresponds with the scene control for 10 seconds (until the word RECORDING is displayed).
- 2) Set the states of the lighting levels and other electrical appliances that you want to capture as part of the scene. On any C-Bus2 switches in the network, you can switch buttons on, or set them to a specific level (in the case of dimmers). To capture an off state, switch a button on and then off.
- 3) Press and hold the scene control button for 1 second (until the word RECORDING changes to SCENE). This exits scene record mode.

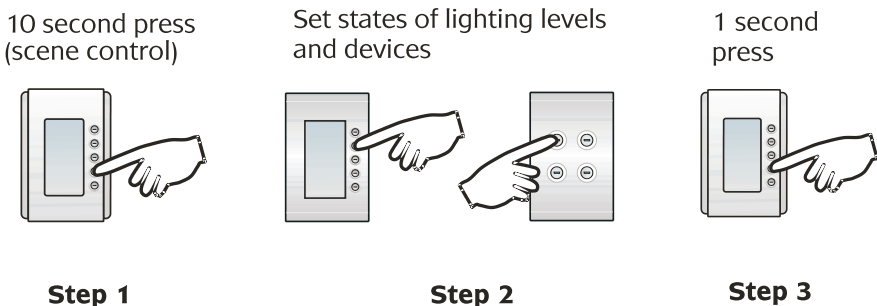

Figure 8. Recording a scene

9.0 Specifications

Parameter	Description
Status indicators	Blue, one indicator per button (dimnable)
Backlight	White, user configurable (dimnable)
Warm-up time	5 seconds
Operating temperature range	0 to 45 °C
Operating humidity range	10 to 95% RH

Refer to the Installation Instructions for more detailed specifications.

10.0 Limited Warranty

C-Bus 'A' Series DLT products carry a two-year warranty against manufacturing defects (refer to Warranty Statement).

Technical Support and Troubleshooting

For further assistance in using this product, consult your nearest Clipsal Integrated Systems (CIS) Sales Representative or Technical Support Officer.

Technical Support Contact Numbers	
Australia	1300 722 247 (CIS Technical Support Hotline)
New Zealand	0800 888 219 (CIS Technical Support Hotline)
Northern Asia	+852 2484 4157 (Clipsal Hong Kong)
South Africa	011 314 5200 (C-Bus Technical Support)
Southern Asia	+603 7665 3555 Ext. 236 or 242 (CIS Malaysia)
United Kingdom	0870 608 8 608 (Schneider Electric Support)

Technical Support Email: tech.training@clipsal.com.au

Product of Clipsal Australia Pty Ltd

A member of Schneider Electric

Contact us: clipsal.com/feedback

National Customer Service Enquiries:

Tel 1300 2025 25

Fax 1300 2025 56

clipsal.com

Clipsal Australia Pty Ltd reserves the right to change specifications, modify designs and discontinue items without incurring obligation and whilst every effort is made to ensure that descriptions, specifications and other information in this catalogue are correct, no warranty is given in respect thereof and the company shall not be liable for any error therein.

© Clipsal Australia Pty Ltd. The identified trademarks and copyrights are the property of Clipsal Australia Pty Ltd unless otherwise noted.